

*DMS-100/200 System
Hardware Planning Guide: 1997-1998*

*A summary of the many benefits of new DMS SuperNode
hardware solutions*

AccessNode, AccessNode Data Direct, ADAS, Concorde, Cornerstone, DataSPAN, DMS, DMS-10, DMS-100, DMS-200, DMS-Bus, DMS-Core, DMS-MTX, Internet Thruway, Magellan, Meridian Digital Centrex, MAP, Nortel, Passport, Rapport, SL-100, SuperNode, S/DMS TransportNode, TOPS, Vector, and the globemark are trademarks of Northern Telecom.

Datapath is a trademark used by Northern Telecom under license.

PowerPC is a trademark of International Business Machines, Incorporated.

Motorola, 68000, 68020, 68040, and 68060 are trademarks of Motorola, Incorporated.

CLASS is a servicemark of Bell Communications Research, Incorporated.

Ethernet is a trademark of Xerox Corporation.

All other trademarks are the property of their respective holders.

.....

This advance planner summarizes the hardware enhancements to the DMS SuperNode system in the next two years, and beyond, that offer new computing power, reliability, and flexibility to help network providers succeed in today's changing, competitive market.

Deregulation, long holding-time Internet calls, service penetration, wire center consolidation, and a reduced work force place a heavy burden on current switching systems. Network planners are faced with the challenge of being ready for the future long before it arrives. To do this, they need switching systems that are flexible, powerful, and future-ready.

Meeting the Challenge

Nortel (Northern Telecom) is in a unique position to help the network provider meet these challenges. Today, we offer the largest menu of telephony and data services in the industry, with flexible, evolving hardware and software platforms already providing the next generation of subscriber services. DMS SuperNode solutions deliver these high-demand services across multiple networks—including wireless and cable—and tap the potential of Advanced Intelligent Networking, switch-based personal communications services, and voice-recognition solutions to create a whole new breed of revenue-generating services.

The *DMS-100/200 Hardware Planning Guide* summarizes new hardware capabilities developed with input from customers, Bellcore's Technical References, and emerging industry and international standards. This advanced planning document presents the most recent view of hardware requirements and should be used for planning purposes only. Nortel announces changes to hardware and software requirements as they are identified. For more information, refer to pertinent System Engineering Bulletins, Northern Telecom Publications (NTPs), and marketing documents (such as *Product/Service Information*, *Product/Service Update*, and *Feature Planning Guide* documents), or contact your Nortel representative.

The DMS SuperNode system, built on a fully redundant hardware architecture for enhanced performance, is continuously evolving to meet the demands of a constantly changing marketplace.

➤ *Reshaping the Network*

The telecommunications market has changed significantly in recent years. Internet access, telecommuting, work-at-home, and other long holding-time applications are placing increased demands on a network previously engineered for voice traffic. Deregulation, competition, new entrants, and new technologies are also reshaping the network model.

To avoid data traffic congestion without the costs of network overbuild, the current switch-centric narrowband network is evolving to a distributed network-centric broadband model. In this multi-media, multi-component “SuperNet” design, a variable mix of switching nodes and processing systems communicate together as a high-speed wide area network. Built on a survivable SONET fiber ring with asynchronous transfer mode (ATM) inlay, this network design migrates service processing to specialized nodes (such as voice servers and video servers).

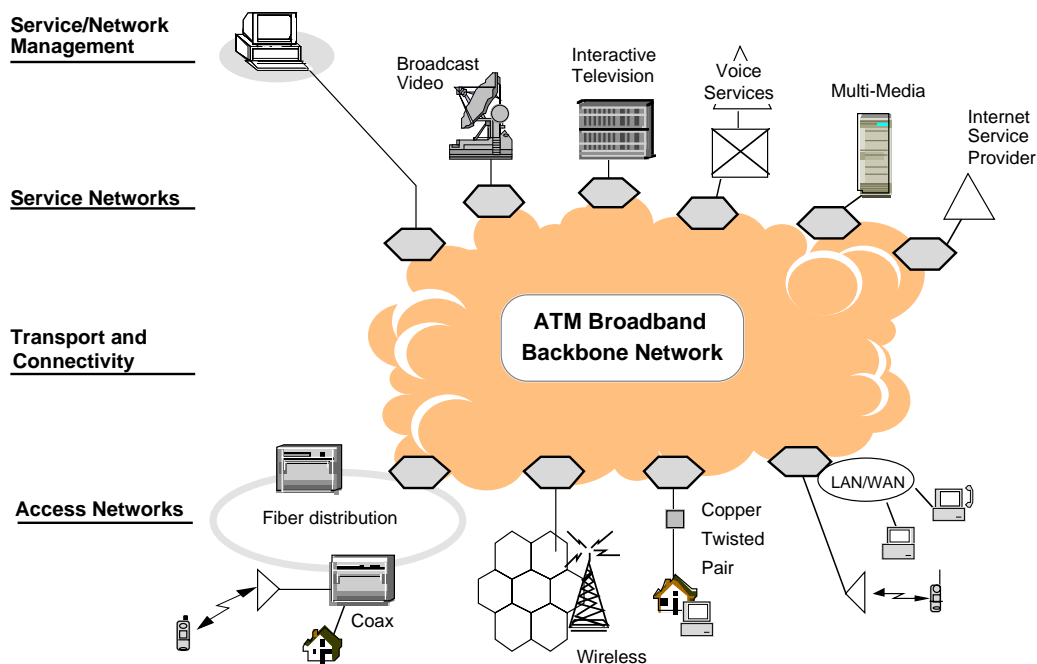

New Network Model *The Network Becomes the Switch*

Distributed processing provides an efficient, self-healing network infrastructure that offers higher service velocity, significantly expanded bandwidth, enhanced reliability, and reduced network cost of ownership.

Nortel focuses on delivering the power, capacity, and capabilities to support this model of the emerging network by continuously enhancing DMS SuperNode hardware systems in timely and cost-effective ways.



Voice Network Evolution

Nortel plans a gradual migration of broadband technology into the narrowband network, to ensure a least-cost evolution while enhancing the value of service provider investments. A few key examples of new solutions include:

Extended Architecture (XA) Core:

a high capacity, multiple processor platform for the DMS system. This high-end processor offers scalable processing and the capacity to support future advanced services in large offices. As the network evolves, XA-Core can be deployed on a network node to operate as a network-level call processing server. Refer to pages 16 and 17 for more information.

SPM: a next-generation, multi-application DMS switch peripheral that provides a direct, high-capacity OC-3 SONET interface for interoffice trunking and interexchange carrier connection. Investigation is currently underway to access the feasibility of integrating direct STS-1 and ATM interfaces onto the SPM. Refer to pages 40 to 43 for more information.

Internet Thruway: is the industry's first portfolio of data access solutions that completely bypasses the voice switch. The initial Internet Thruway offering removes the burden of long-duration data and Internet traffic on the voice network by elegantly diverting these calls to a data network—before they reach the switching office. Refer to pages 58 and 59 for more information.

Nortel 1-Meg Modem Service is a cost-effective modem replacement that can compete favorably against cable modems. This quick-to-market solution transforms existing copper plant into integrated broadband loops—with no new peripherals or adjunct equipment. The Nortel 1-Meg Modem Service introduces a 1 megabit-per-second downstream, 120 kilobits-per-second upstream, and regular 28.8 kilobits per second POTS capabilities—all on an existing telephone line. As a stepping stone to full, multimegabit Digital Subscriber Line (xDSL) service, this solution complements and strengthens a network provider's overall xDSL strategy. Refer to pages 46 and 47 for more information.

Access Solutions: Nortel AccessNode

multiservice access vehicle makes full use of service adaptive line card technology to hold down operating costs in a variety of different configurations, including access rings in metro areas and enterprise networks. Refer to the *AccessNode Application and Feature Overview Guide* (publication number 56030.16/11-96 issue 2) for more information. **S/DMS**

TransportNode supports the broadband transport network by providing SONET-based communication at OC-3, OC-12, OC-48, and OC-192 rates. Refer to the *S/DMS TransportNode Overview* (56015.16/10-96) for more information.

Management Solutions: ATM and SONET network elements will be managed through an integrated network management platform. *Nodal* DMS switch operations, administration, maintenance, and provisioning (OAM&P) can be managed through time- and labor-saving applications resident on the **SuperNode Data Manager (SDM)** platform. Refer to pages 68 to 71 for more information about the SDM.

Magellan Product Family: ATM backbone switching can be provided by Nortel's **Vector** and **Concorde** switches, while the Magellan **Passport** switch can serve as an advanced services access vehicle. For more information about these products, all available now, refer to the latest edition of the *Magellan Product Guide* (55032.11).

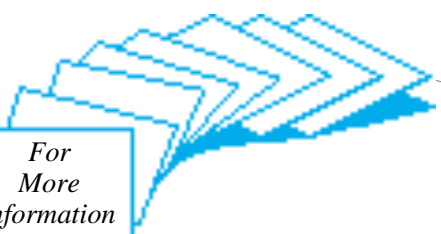

*For
More
Information*

Need Electronic Access?

*Do you need to cut and
paste parts of this
document? Would you like
instant access to Nortel
information as soon as it
becomes available?*

*This document and dozens
of other Nortel marketing
and advance-planning
documents are available
electronically through the
NORTEL ONLINE bulletin
board.*

*Just call 1-800-4 NORTEL
to receive the free software
that will put you online.*

For a summary of our leading-edge software solutions, refer to the latest issue of the *DMS-100/200 Feature Planning Guide*, document number 50004.11



AT A GLANCE

The tables on the following pages summarize the hardware descriptions in this document.

The tables on the following pages summarize the latest DMS SuperNode hardware guidelines. Descriptions of the hardware mentioned in these tables can be found in this and the previous edition of the *Hardware Planning Guide*, grouped under the following categories:

- ◆ Minimum Configuration Baselines page vi
- ◆ Optional Feature Configurations page viii
- ◆ New Hardware page x
- ◆ Network Modernization page xii

These categories streamline the hardware planning process by grouping together hardware used for a common purpose. The tables on the following pages are generalized, and are *not* intended to be comprehensive. Also note that hardware items can appear in more than one category.

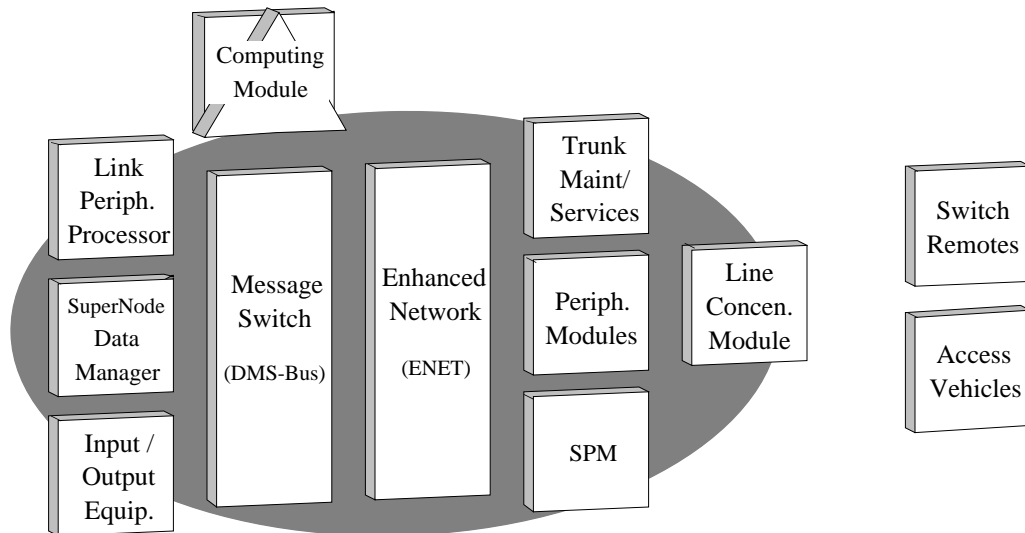

Key Components of the DMS SuperNode System
This document details each subsystem in separate chapters

➤ *Minimum Configuration Baselines*

The following tables list the base-level hardware that must be in place to upgrade to a particular NA00x product release. Each table lists the lowest-level hardware that must be in place prior to upgrading to a particular NA00x product release. The following is for planning purposes and should not be used for provisioning.

- NOTES:**
- Each release must meet the previous software release's hardware baseline.
 - For Computing Module hardware, run the Flexible Advanced Capacity Engineering Tool (FACET) to determine specific office requirements.

NA006

Subsystem	Minimum, For All PCLs	Order Code
Computing Module (CM)	Offices with more than 20,000 lines require Series 50 (with 24- and 96-megabyte memory mix) or higher. Offices with less than 20,000 lines can use existing 68000-series processors based upon a detailed assessment by Nortel capacity tools DMS-200 tandem office with greater than 40,000 trunks must have Series 50 (with 24- and 96-megabyte memory mix) or higher	NT9X10AA NT9X14DB NT9X14EA
System Load Module (SLM)	SLM III required for all loads on DMS SuperNode SE SLM III required on DMS SuperNode if load exceeds 240 Megabytes	NT9X44AD
Enhanced Network (ENET)	If deployed, then a 16-Megabyte Processor is required (please note the ENET itself is not a hardware requirement)	NT9X13KA
Link Peripheral Processor (LPP)	All LPP Link Interface Units (LIUs) require the 8-Megabyte Integrated Processor and Frame Bus (IPF) circuit pack	NTEX22BB <i>or</i> NTEX22BA
Peripheral Modules	The SCM-100A (SMA) and Expanded SCM-100A (ESMA) require this 16-Megabyte Processor	NTAX74AA
	The SMA and ESMA require this Enhanced ISDN Signaling Preprocessor (EISP) at one of these vintage levels	NTBX01AC <i>or</i> NTBX01BA

NA007

Subsystem	Minimum, For All PCLs	Order Code
Computing Module	<p>Minimum: Series 50 (with 24- and 96-megabyte memory mix) with NT9X12AD Port Card and NT9X26DC Remote Terminal Interface</p> <p>Series 70 Extended Memory is required if the office has greater than 85,000 lines with medium amount of business services deployed or greater than 50,000 lines with high amount of business services. This applies to NA007 offices without Local Number Portability (LNP). A capacity study must be performed on these offices planning to deploy LNP</p>	NT9X10AA NT9X14DB NT9X14EA NT9X12AD NT9X26DC NT9X10CA NT9X26FA
Link Peripheral Processor	MSB7 no longer supported. Link Peripheral Processor, DMS SuperNode SE Link Interface Shelf, or Frame Link Interface Shelf required for CCS7	various codes

NA008

Subsystem	Minimum, For All PCLs	Order Code
Computing Module	<p>Minimum: same as NA007</p> <p>Series 70 Extended Memory is required if the office has greater than 65,000 lines with medium amount of business services deployed <i>or</i> greater than 40,000 lines with high amount of business services. This applies to NA008 offices without LNP. A capacity study must be performed on these offices planning to deploy LNP</p>	NT9X10CA NT9X26FA

NA009

Subsystem	Minimum, For All PCLs	Order Code
Remote Switching Center-S	Requires 16-Megabyte Processor	NTAX74AA
	Requires Enhanced ISDN Signaling Preprocessor (EISP) at one of these vintage levels	NTBX01AC <i>or</i> NTBX01BA

➤ *Optional Feature Configurations*

The following table lists optional features and identifies the additional hardware required to support them. Over time, technical requirements may upgrade the following feature-specific hardware to become baseline. Please note that actual hardware availability may be later than the software availability shown in the first column.

Release	Feature/service	Subsystem	Hardware required	Order code
Up to NA003	<i>CLASS Spontaneous Call Waiting Display (SCWID / DSCWID)</i>	Peripheral Modules	Message Protocol and Tone Generator	NT6X69AD <i>except:</i> ESMA (NA004): NTMX76CA RSC-S: NTMX76AB
	<i>Digital Test Access with SMA and ESMU</i>		Enhanced Time Switch (ETS)	NTAX78AB
	<i>ISDN and Meridian Business Sets on the DMS-1 URBAN</i>		Expanded Subscriber Carrier Module-100 URBAN (ESMU)	<i>various codes</i>
	<i>Talk Battery Alarm (on the LCM)</i>		Two World Line Cards	NT6X17BA
	<i>Extended Distance Capability (RSC-S)</i>	Switch Remotes	<ul style="list-style-type: none"> Extended Distance Messaging packs Host: XPM PLUS and DS-1 Interface packs 	NTMX76AA NT6X50AB
NA004	<i>TOPS Operator Centralization</i>	Operator and Directory Services	TOPS Message Switch or Enhanced TOPS Message Switch (in place of Digital Carrier Module)	<i>various codes</i>
	<i>Digital Test Access with ESMA</i>	Peripheral Modules	Matrix card	NTMX75BA
	<i>Peripheral/Remote Loader (except ESMA, SMA, and peripherals with NTAX74AA)</i>		Peripheral/Remote Loader	NT7X05AA
	<i>Data Communications greater than 2400 baud</i>	Input/Output Equipment	Enhanced Multi-Protocol Controller	NT1X89BB
	<i>Routeset expansion</i>	Link Peripheral Processor	<ul style="list-style-type: none"> CCS7 External Routers 8-Megabyte IPF 	<i>various codes</i> NTEX22BB NTEX22BA
	<i>Network Reliability Council Items in NA004</i>		8-Megabyte IPF	NTEX22BB

Release	Feature/service	Subsystem	Hardware required	Order code
NA005	<i>ISDN Packet</i>	Peripheral Modules	Enhanced D-Channel Handler (EDCH) card	NTBX02BA
NA006	<i>Network Reliability Council Items in NA006</i>	Link Peripheral Processor	8-Megabyte IPF	NTEX22BB
	<i>TR-303 support</i>	Peripheral Modules	16-Megabyte Processor with SMA and ESMA	NTAX74AA
	<i>Enhanced Terminal Access and Exception Reporting</i>	OAM&P Applications	SuperNode Data Manager (SDM)	NTRX50FA (fault-tolerant)
NA007	<i>Peripheral/Remote Loader on XPM PLUS peripherals except ESMA and ESMU (support for the new NTAX74AA processor with the Peripheral Loader is planned for NA008, see below)</i>	Peripheral Modules	Peripheral/Remote Loader	NT7X05AA
	<i>ISDN Line Drawer for Remotes (ILDR)</i>	LCM-Based Remotes	To support 64 kbps clear channel signaling: <ul style="list-style-type: none"> Both host and remote require this vintage of the DS-1 Interface card This vintage of LCM Processor required 	NT6X05DA NT6X50AB (RSC-S: NTMX81AA) NT6X51DA
	<i>AMADNS Data Server</i>	OAM&P Applications	SuperNode Data Manager (SDM)	NTRX50FA (fault-tolerant)
NA008	<i>Black Box Fraud Prevention</i>	Peripheral Modules	Peripherals must have XPM PLUS installed	NTMX77AA
	<i>Peripheral/Remote Loader on XPM peripherals with the NTAX74AA processor (except ESMA and ESMU)</i>		Peripheral/Remote Loader	NT7X05AA

➤ *New Hardware*

To keep ahead of rapid technology drives moving forward in all parts of the network, hardware is continuously enhanced. New hardware offers the latest features and supports current functionality with new efficiencies and cost-saving capabilities.

Existing equipment in the field scheduled to be manufacture discontinued *still receive full Nortel customer service support*. Product replacement is not required unless feature or baseline driven (shown in the previous tables). The following lists major equipment only (this listing is not exhaustive). For more details, including lists of circuit packs involved, refer to:

<i>DMS-100/200 Portfolio Simplification Product/Service Information (PSI)</i>	50127.16
<i>DMS-100/200 Portfolio Simplification 1Q96 PSI</i>	50133.16
<i>DMS-100/200 Portfolio Simplification 2Q96 PSI</i>	50138.16
<i>DMS-100/200 Portfolio Simplification 4Q96 PSI</i>	50149.16

The entries in this table are arranged by the Manufacture Discontinued (MD) date of the replaced hardware.

Subsystem	Replaced hardware	MD date	New hardware	Available
System Load Module (SLM)	SLM IA and SLM II	3Q96	SLM III (NT9X44AD)	Now
TR-303 Integrated Switch Access	SCM-100A (SMA) [NT6X02TE, TF, TH]		Extended SCM-100A (ESMA) [NTQX90AA and NTMX90BA]	
Line Concentrating Module	Type A and Type B Line cards (NT6X17AC, NT6X18AA, and NT6X18AB)	4Q96	World Line Cards (NT6X17BA and NT6X18BA)	
Customer Premises Equipment (ISDN)	Nortel-manufactured Standalone NT1 (NTBX80AA)		Alpha Telecom models: TEC01910 (10W power) or TEC01903 (2W power)	
Trunk / Maintenance Services	Office Alarm Unit Dead System for Maintenance Trunk Module (MTM) NT3X82AA, AB, AC, AD		Office Alarm Unit for MTM and Integrated Service Module (ISM) [NT3X82AH, NT3X82AJ]	
Network Applications Vehicle (NAV)	NAV Controller Bay (NTFX55BA)	NAV Controller Bay (NTFX55BB)		
Trunk / Maintenance Services	Trunk Test Circuits (TTU, TTT, DTU)	2Q97	Enhanced Digital Test Unit (EDTU) [NT4X45AA]	4Q97
DMS SuperNode SE Computing Module	68000 processor: <ul style="list-style-type: none"> Series 20 Series 30 Series 40 	3Q97	BRISC processor: <ul style="list-style-type: none"> Series 50 Series 60 Series 70 / 70 EM 	Now (except Series 70 EM, which is 4Q97)

Subsystem	Replaced hardware	MD date	New hardware	Available
Input/Output Equipment	Input/Output Controller (IOC) shelf/frame [NT1X61AG and NT1X62CB]	4Q97	Input/Output Module (IOM)	2Q97
Switch Fabric	Double Shelf Network (DSN)	4Q98	Enhanced Network (ENET)	Now

After products have been announced as MD, subsequent software releases continue to support them—up to an announced software release. The following table identifies the last NA00x product release that will support a hardware or software product previously announced as MD.

Hardware / Software	Last release supported	Replacement
Message Switch and Buffer for CCS7 (MSB7)	NA006	Link Peripheral Processor (LPP)
4-Megabyte Link Interface Unit for CCS7 (LIU7)	NA006	8-Megabyte Integrated Processor and Frame Bus Interface (IPF)
Subscriber Carrier Module - Rural (SMR)	NA007	Various digital loop carrier interfaces (the SMR may be upgraded to SMU)
Advanced Intelligent Network (AIN) 0.0 Primer Software	NA009	AIN Essentials and AIN Service Enablers ordering codes

Network Modernization

The following lists leading hardware technology designed to offer network providers significant competitive advantages. Considered optional, these building blocks for future networks can reduce the cost of DMS SuperNode ownership, streamline maintenance procedures, and enhance network performance.

Planned GA	Subsystem (Chapter Name)	New hardware	Starting Page
Now	Access Vehicles	Internet Thruway (Release 2 in 3Q97)	58
		Rapport Dialup Switch	60
3Q97		AccessNode Express	60
4Q97	SuperNode Data Manager (SDM)	Fault-tolerant SDM for operations, administration, maintenance, and provisioning (OAM&P)	68
	Computing Module	Series 70 Extended Memory	14
	Remotes	ISDN Line Drawer for Remotes	54
4Q98	Link Peripheral Processor	32-Megabyte Integrated Processor and Frame Bus Interface (IPF)	67
1Q99	Computing Module	Extended Architecture (XA)-Core	16
1H99	SPM	SPM and its interfaces	40

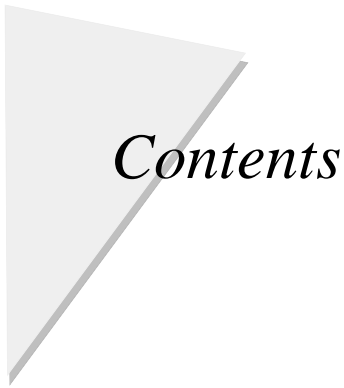

Contents

Hardware Planning Guide Overview.....	4
<i>Digest of Hardware Solutions.....</i>	4
<i>Full Support after MD.....</i>	5
New Switch Applications.....	6
<i>DMS Large Tandem.....</i>	6
<i>CCS7 External Routers.....</i>	7
<i>DMS-100 Wireless.....</i>	8
Computing Module (CM).....	10
<i>Keep Ahead of Expanding Subscriber Demands.....</i>	10
<i>Since the Previous Edition.....</i>	11
<i>Planned Enhancements.....</i>	11
<i>System Load Module III [NT9X44AD].....</i>	12
<i>Series 60 Processor [NT9X10AA].....</i>	13
<i>Series 70 Processor [NT9X10BA].....</i>	14
<i>Series 70 Extended Memory [NT9X10CA].....</i>	14
<i>Extended Architecture (XA) Core.....</i>	16
Message Switch (MS).....	18
<i>High-Throughput Frees Up the Computing Module.....</i>	18
<i>New Interface Cards.....</i>	18
<i>Since the Previous Edition.....</i>	19
<i>Planned Enhancements.....</i>	19
<i>Digital Phase Lock-Loop Clock Card [NT9X53AD].....</i>	19
Enhanced Network.....	20
<i>Immediate OAM&P and Performance Advantages.....</i>	20
<i>Planned Enhancements.....</i>	22
<i>Processor Upgrade [NT9X13KA].....</i>	22
<i>DMS SuperNode SE Line Upgrade.....</i>	23

Trunk Maintenance / Services	24
<i>Additional EDRAM Capabilities with NA005</i>	24
<i>Since the Previous Edition</i>	25
<i>Planned Enhancements.....</i>	26
<i>Metallic Line Test Access Consolidation [NTFX40].....</i>	26
<i>Enhanced Digital Test Unit (EDTU) [NT4X45AA].....</i>	27
Peripheral Modules (PMs).....	28
<i>High Efficiency and Flexibility.....</i>	28
<i>XPM PLUS.....</i>	29
<i>Since the Previous Edition.....</i>	30
<i>Planned Enhancements.....</i>	32
<i>Enhanced D-Channel Handler [NTBX02BA]</i>	32
<i>Peripheral/Remote Loader [NT7X05AA].....</i>	33
<i>16-Megabyte Processor [NTAX74AA]</i>	34
<i>Expanded SCM-100A (ESMA).....</i>	36
<i>Integrated Channel Bank on ESMA.....</i>	38
<i>MBS on Generic TR-303.....</i>	39
<i>Global Tone Receiver [NT6X92EA].....</i>	39
SPM	40
<i>Capacity and Power.....</i>	40
<i>Planned Enhancements.....</i>	41
<i>SPM.....</i>	41
<i>OC-3 Trunking.....</i>	42
<i>STS-1 Digital Trunking.....</i>	43
<i>ATM Interface</i>	43
Line Concentrating Module (LCM)	44
<i>LCM Link Expansion to Support Internet.....</i>	44
<i>Since the Previous Edition.....</i>	45
<i>Planned Enhancements.....</i>	45
<i>LCM Processor [NT6X51DA]</i>	46
<i>1-Meg Modem Service [NTEX54AA, NTEX17].....</i>	46
Switch Remotes.....	48
<i>Cost-Effectively Extends the Reach of the DMS System</i>	48
<i>Key Capabilities.....</i>	49
<i>Rings Enhance Survivability.....</i>	50
<i>EDC Reduces Hardware.....</i>	50
<i>RSC to RSC-S Conversion with the RSCE.....</i>	51
<i>Since the Previous Edition.....</i>	52
<i>Planned Enhancements.....</i>	53

<i>OPAC: OC-1 SONET Module [NT2A Series]</i>	53
<i>ISDN Line Drawer for Remotes (ILDR) [NT6X05DA]</i>	54
<i>16-Megabyte Processor for RSC-S [NTAX74AA]</i>	55
<i>Access Vehicles</i>	56
<i>Reliable Multivendor Support</i>	56
<i>Since the Previous Edition</i>	57
<i>Planned Enhancements</i>	58
<i>Internet Thruway</i>	58
<i>Rapport Dialup Switch</i>	60
<i>AccessNode Express</i>	60
<i>Link Peripheral Processor (LPP)</i>	62
<i>Modular Design Evolves with the Network</i>	62
<i>Mixed Application Configurations</i>	63
<i>Since the Previous Edition</i>	65
<i>Planned Enhancements</i>	65
<i>Digital Phase Lock-Loop Clock Card [NT9X53AD]</i>	65
<i>8-Megabyte IPF [NTEX22BB]</i>	66
<i>32-Megabyte IPF [NTEX22CA]</i>	67
<i>DMS SuperNode Data Manager (SDM)</i>	68
<i>Delivers Competitive Advantages to Providers</i>	68
<i>DMS SuperNode Data Manager (SDM) [NTRX50FA]</i>	70
<i>Input/Output Equipment (IOE)</i>	72
<i>For Serial Data Communications</i>	72
<i>Planned Enhancements</i>	73
<i>Enhanced Multi-Protocol Controller [NT1X89BB]</i>	73
<i>1 - 2 Gigabyte Disk System for DPP/BMC</i>	74
<i>Input/Output Module (IOM)</i>	75
<i>Reference</i>	76
<i>Hardware Listed by Ordering Code</i>	76
<i>Abbreviations and Acronyms</i>	79
<i>Exhaustive Index</i>	83

Hardware Planning Guide Overview

Find the information you need at a glance.

Pertinent order code(s)
Will not show if there are many associated codes or an ordering code is pending

Hardware or enhancement name

Requirement information
Information shows if hardware is required for feature or PCL

Availability Information

Series 70 Processor Extended Memory	Prerequisite for:	Available
NT9X10CA	NA007 CM loads greater than 608 megabytes, or exceeding the realtime of the Series 60	LTD: 3Q97 GA: 4Q97 NA007

Value
Benefits to the network provider

How hardware will be introduced
Does it replace existing hardware? Is it required for a release or feature?

If hardware is currently available, an entry here, called "Minimum software level", identifies the minimum software level required in the Computing Module

References
Where to find more information

Value ➤ Increased capacity—Expanded memory addressing and enhanced processing capacity enhances average call-processing times.

➤ Enhanced reliability—For increased immunity from memory errors, an Error Detection and Correction (EDAC) function checks parity throughout the on-board memory continuously and corrects corruptions automatically.

Drivers Increased competition has raised the demand for advanced services, often requiring network providers to accelerate feature availability to satisfy new subscriber needs. By meeting current and future feature availability requirements, this processing option—intended for large offices—ensures that the DMS-100 Family of switches is the most powerful, versatile, and fully featured in the industry.

Transition Plan The Series 70 is ideal for central offices with large line/trunk configurations and for those deploying high-capacity services such as Advanced Intelligent Networking and National ISDN-2/3.

For More Information

- Series 70 Extended Memory Option Boosts Performance; Product/Service Update article (50049.17/02-97)

Availability Information

LTD: Quarter and year scheduled to have limited availability.

GA: Quarter and year scheduled to have general availability.

NA00x Future product release scheduled to provide supporting software.

Now The hardware is currently available, and its supporting software is available in NA007 or earlier.

Drivers
The key market, technology, and cost reduction pressures driving the need for new hardware or enhancement.

The hardware specifications and availability dates in this document are specifically for:

- DMS-100 End Office
- DMS-200 Access Tandem
- DMS-100 Service Switching Point
- DMS-100/200 without TOPS

—in the North American market. Availability and requirements in other markets may vary.

DIGEST OF HARDWARE SOLUTIONS

By providing an overview of new hardware and hardware enhancements scheduled to become generally available in the next few years for the DMS SuperNode, this document serves as a planning tool for network planners, marketers, and other service provider personnel who need a convenient summary of future hardware offerings—and want to know how these can help generate new revenue, cut costs, and streamline operations.

For more information, please contact your local Nortel representative, or call us at 1-800-4 NORTEL (1-800-466-7835). Our World Wide Web (Internet) home page is at URL <http://www.nortel.com>

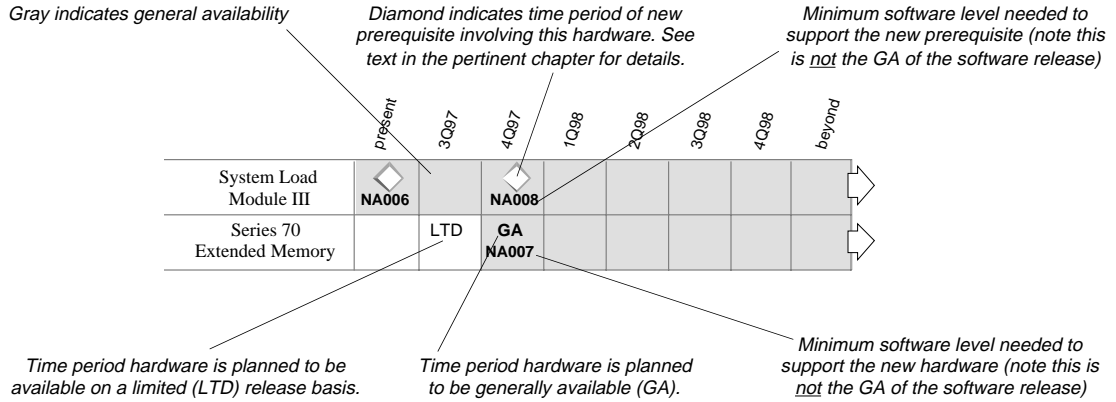

Chapters

NA010	4Q98
-------	------

Each chapter in this document represents a different subsystem of the DMS SuperNode, and begins with introductory information that may:

- ◆ Describe the subsystem as a whole in summary form.
- ◆ Provide any special information pertaining to the subsystem.
- ◆ Summarize significant future software deliverables that enhance the value and performance of the subsystem hardware.
- ◆ Present a graph (see illustration above) that conveniently shows the hardware changes discussed in the chapter.

Descriptions

After the introductory material, each chapter discusses specific changes scheduled to be generally available in the next few years. The graphic on the previous page explains the format used for these descriptions. The following table lists current schedules for the general availability of NA00x product releases.

Planned NA00x Releases

Product Release	Scheduled GA
NA006	available now
NA007	available now
NA008	4Q97
NA009	2Q98

FULL SUPPORT AFTER MD

When the *DMS-100/200 Hardware Planning Guide* announces equipment that is scheduled to be Manufacture Discontinued (MD), please note that existing equipment in the field continues to receive full Nortel customer service support until replacement is warranted or the equipment is no longer required. The new hardware simply replaces all shipments of initial and extension equipment, after customer acceptance, at a given release. Subsequent software releases continue to support the discontinued hardware, until future notice.

*This advance planning document summarizes the applications and benefits of scheduled hardware changes—and is **not** intended to be used as a provisioning guide. Some changes in availability may occur based on market need and engineering requirements.*

New Switch Applications

This chapter details new node-level switch applications:

- ◆ *DMS Large Tandem*
- ◆ *DMS-100 Wireless*

➤ **DMS Large Tandem**

Cost-effective capacity growth for increased network Tandem traffic.

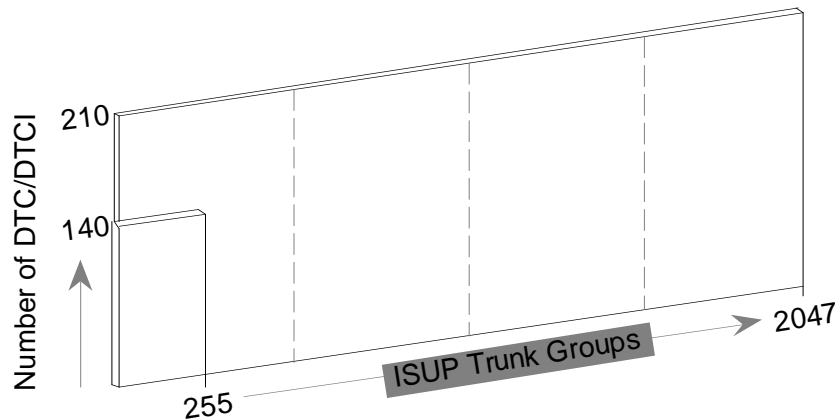

Gain the Largest Tandem in the Industry with a Modest Upgrade

Hardware	Page
CCS7 External Routers	7

SUPPORT UP TO 100,000 ISUP TRUNKS

Nortel now offers the largest Access Tandem in the industry—cost-effectively. By expanding the support of Digital Trunk Controller peripherals (DTCs and DTCIs) from the traditional level of 140 to a new maximum of 210, a DMS-200 system can support up to 2,047 ISUP trunk groups, or some 100,000 trunks, based on traffic.

This expansion enhances existing access tandem capabilities and saves significant operating costs to the network provider through benefits such as:

- ◆ Managing fewer network elements for the same amount of traffic.
- ◆ Differing the redistribution of trunk groups as growth occurs.

The modest hardware additions expands capacity, cost-effectively, while making full use of existing hardware investments.

This expansion requires the 8-Megabyte Integrated Processor and Frame Bus Interface card (NTEX22BB).

CCS7 External Routers	Prerequisite for:	Available
	NA004 Routeset expansion above 255	Now

To enhance switch performance and support emerging network-wide services in the CCS7 network, External Routers—Application Specific Unit (ASU) circuit packs that reside in the LPP—complete a number of external routing tasks. In turn, this capability supports a higher number of routesets configurable for each DMS-100 Service Switching Point (SSP) to a new maximum of 2,047 as well as contributing to network robustness during high CCS7 activity.

Value

- **Enhances switch performance**—External Routers offload the processing of CCS7 route-change messages from Digital Trunk Controller No. 7s (DTC7s). This efficiency permits expanding the number of supported routesets from 255 to a maximum of 2,047—to offer enhanced flexibility and connectivity for each DMS-100 SSP serving as a CCS7 node.
- **Supports emerging high-messaging services**—External routing permits the implementation of new applications and enhancements that could otherwise cause messaging overload. The increased routeset support provides expanded service diversity and ubiquity.
- **Increases DTC7s support**—Together with currently scheduled software enhancements, the maximum number of Digital Trunk Controller No. 7s that can be supported in a central office increases from 140 to 210.

Drivers

The CCS7 Intelligent Network continues to expand with capabilities that move well beyond its original design. Especially in conjunction with services that interact with service control point (SCP) databases and applications, CCS7 messaging has grown in amount and complexity. The DMS SuperNode offers greater CCS7 capacity, flexibility, and robustness to help the service provider reap full revenue potential from network centrex, CLASS, ISDN, Enhanced 800, Private Virtual Networking, and a number of emerging database-inquiry services.

Transition Plan

External Router ASUs are required for:

- ◆ General external routing capabilities (software TEL00008).
- ◆ CCS7 DMS-100 SSP routeset expansion from 255 to a maximum of 2,047 (software TEL00004).

The software to support both features has been available since the NA004 time frame.

Routeset expansion requires the 8-Megabyte Integrated Processor and Frame Bus Interface card (NTEX22BB, described on pages 66 and 67).

For More Information

- *Feature Planning Guide 1995-1996*; pages 79 and 80 (500004.11/01-95)

➤ DMS-100 Wireless

Simplifies the migration to becoming a full-service provider

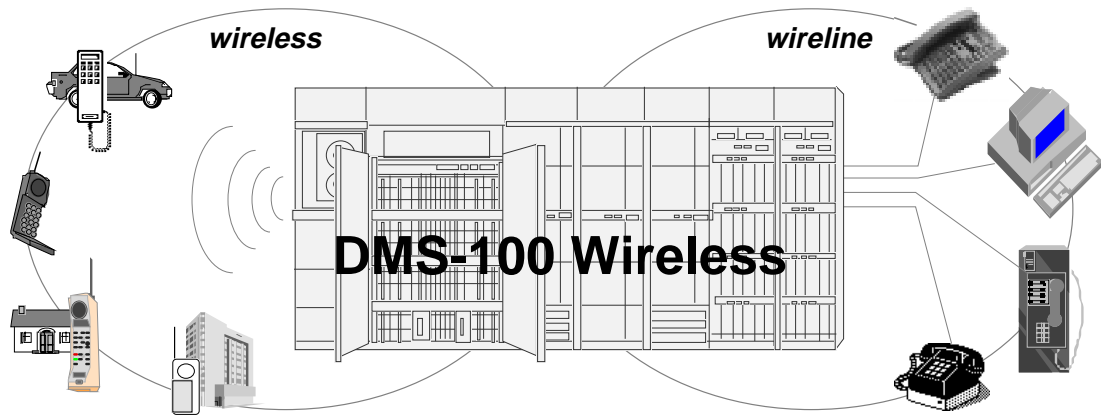

Enables the Network Provider to Capitalize on a Full Range of Wireline and Wireless Services on One Integrated Platform

INTEGRATED ACCESS TO NEW REVENUE OPPORTUNITIES

To ease network provider entry into the promising new personal communications services (PCS) market, Nortel offers the new DMS-100 Wireless switching system. This new switch type integrates the DMS-100/200 and DMS Mobile Telephone Exchange (MTX) digital switching systems onto a single common hardware platform—to deliver fully featured:

- ◆ Wireline business and residential services
- ◆ PCS and cellular wireless services

Established providers can leverage their installed base of DMS-100 wireline systems to deliver advanced mobile services with a minimum investment in capital and training. *New entrants* can use this solution to deliver the industry's leading portfolio of competitive business, residential, and mobility services on a single, integrated product platform.

PART OF INTEGRATED WIRELESS SOLUTIONS

Integrated Wireless Solutions is Nortel's end-to-end turnkey offering that includes—in addition to the DMS-100 Wireless system—a range of design, integration, and deployment services. Designed to help reduce startup and training costs, Integrated Wireless Solutions offers a comprehensive menu of services that draws on Nortel's depth of experience in building both wireline and wireless networks. Network providers can choose from network consulting, service deployment, and operations support programs such as billing, systems integration, and network management.

For more information about this new integrated platform, refer to the "DMS-100 Wireless" chapter in the *Feature Planning Guide 1997-1998*, Issue 17, and the *Integrated Wireless Solutions Support Carrier Entry to PCS* article in the *Product/Service Update 50049.17/02-97*.

BENEFITS OF NEW PLATFORM

The DMS-100 Wireless system offers both established and new entrant providers with a number of benefits, including:

- ◆ Enables new market opportunities with a simple upgrade for established DMS-100 systems (for example, no special adjunct processors are needed). This simplicity enables established providers to leverage existing investments to cost-effectively establish a single point of presence in both traditional wireline and wireless PCS markets.
- ◆ Helps expand revenue potential through broader service offering. Network providers can offer retail PCS directly to their own subscribers, or wholesale PCS to another network provider having a PCS license. Or, they can mix and match retail and wholesale services to optimize overall PCS delivery for maximum revenue potential.
- ◆ Supports all the services available on the DMS-100/200 system at a given release, including:
 - ◇ Meridian Digital Centrex (MDC)
 - ◇ Custom Local Area Signaling Services (CLASS) features
 - ◇ National ISDN and wideband data services
 - ◇ Advanced intelligent network (AIN) and local number portability (LNP)
 - ◇ Call center automatic call distribution (ACD) services
 - ◇ Voice-activated services
 - ◇ Computer-telephony integration (CTI)

- ◆ Offers the majority of the services available on the standalone DMS-MTX system at a given release, including:
 - ◇ Integrated Home/Visitor Location Register (HLR/VLR)
 - ◇ Personal Number Service (requires external database)
 - ◇ Call processing features such as Call Forwarding, Call Waiting, Calling Number Identification, and more
 - ◇ IS-41 Roaming
 - ◇ Credit Card Calling

SYSTEM REQUIREMENTS

The DMS-100 Wireless system initially supports Code Division Multiple Access (CDMA) 1900 MHz service, scheduled for availability in 4Q97. CDMA 800 MHz service support is scheduled for availability in 2Q98. Support for Time Division Multiple Access (TDMA) and Advanced Mobile Phone Systems (AMPS) are planned for later releases. Current DMS-100 Wireless system requirements include:

- ◆ *Processor baseline:* requires at least the Series 60. For larger systems, the Series 70 Extended Memory (EM) processor is required.
- ◆ *CCS7 connectivity:* requires a Link Peripheral Processor (LPP). This may be an LPP already deployed in the office.
- ◆ *Radio Environment Signaling Support:* requires an additional LPP, or a Fiber Link Interface Shelf (FLIS), provisioned with CDMA Interface Units (CIUs) and CDMA Application Units (CAUs).
- ◆ *Digital Trunk Controllers:* requires additional Digital Trunk Controllers (DTCs) to support voice traffic from the wireless environment.
- ◆ *CDMA 1900 MHz radio subsystem* Base Station Controller and Base Station Transceiver cell site equipment.

Currently, the DMS SuperNode SE is planned to be upgradeable to the DMS-100 Wireless in 2Q98.

Computing Module (CM)

A fully duplicated processing engine for today's most advanced network services.

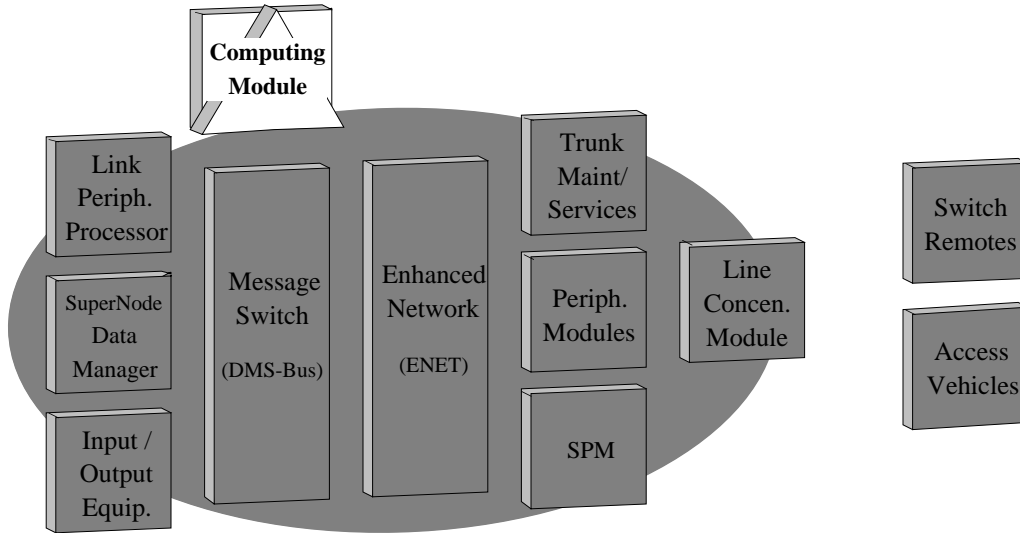

The Computing Module Provides Unparalleled Capacity and Call-Processing Power

Hardware	Page
System Load Module III	12
Series 60 Processor	13
Series 70 Processor	14
Series 70 Extended Memory	14
Extended Architecture (XA) Core	16

KEEP AHEAD OF EXPANDING SUBSCRIBER DEMANDS

To stay ahead of rapid growth in the telecommunications marketplace, network providers want a switching system with power and versatility that can grow while protecting the original investment. Nortel's DMS SuperNode system will continue to meet the shifting requirements of expanding networks into the next century.

With increasing market demand for new advanced services, the memory requirements of the DMS SuperNode Computing Module (CM) will continue to grow. Providers seeking the revenue opportunities of services, such as Advanced Intelligent Networking or National ISDN-2, may need to expand real time and memory configurations in large offices.

Nortel offers this flexibility and computing power with a series of core processors using Reduced Instruction Set Computing (RISC) technology—tailored and improved for telecommunications—known as “BRISC” processors.

To continue to meet the expanding demands of business and residential subscribers, most network providers purchasing or upgrading DMS SuperNodes today are choosing BRISC series processors. Compared to a Series 20, 30, or 40 processor, the BRISC platform built into the Series 50, 60, and 70/70EM processors offers the following advantages:

- ◆ **Helps generate additional revenue** by providing the real time and memory to support new services and expand call capacity. This can result in higher penetration and faster market growth, to strengthen the network provider's competitive position.
- ◆ **Enhances the network provider's service portfolio** by supporting a larger variety of the latest revenue-generating services. New developments offer a higher quality of service, including a 12% to 64% reduction in system restarts/recovery time.
- ◆ **Reduces operating expenses** by cutting costs associated with deploying new services and offering the potential for node consolidation. BRISC offers significant operating cost savings by

streamlining many maintenance tasks, such as a 50% to 85% improvement in Maintenance and Administration Position (MAP) terminal response and as much as a 37% reduction in the One Night Process time (depending on the office).

The figure below illustrates the incremental increase in call processing capacity offered by various processor options.

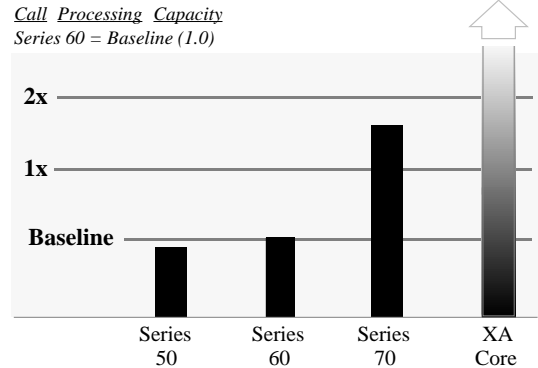

DMS SuperNode Processor Evolution

- ◆ = Significant new prerequisite involving this hardware. See text in this chapter for details.
- = Product is generally available (GA).

	Present	3Q97	4Q97	1Q98	2Q98	3Q98	4Q98	beyond
System Load Module III	◆ NA006		◆ NA008					▶
Series 60 Processor								▶
Series 70 Processor								▶
Series 70 Extended Memory		LTD	GA NA007					▶
XA-Core						LTD		GA 2Q99 ▶

Planned Computing Module Hardware Enhancements

SINCE THE PREVIOUS EDITION . . .

The following—discussed in the previous issue of the *DMS-100/200 Hardware Planning Guide*—is now available as an integral part of the DMS-100/200 portfolio of products.

96-Megabyte Memory Card	Prerequisite for:
NT9X14EA	BCS35 DMS SuperNode SE BCS36 Series 60 NA004 Series 70

The NT9X14EA is optional on the Series 50 (with the Mixed Memory software feature), standard with the DMS SuperNode SE, and required for use with the Series 60 and Series 70 processors. The 96-Megabyte Memory Card is only needed with the Series 70 Extended Memory option (see page 14) when the DMS switch requires more than 512 megabytes of memory.

PLANNED ENHANCEMENTS

System Load Module III	Prerequisite for:	Available
NT9X44AD	<p>DMS SuperNode NA008 Load image size greater than 240 megabytes or in an office with more than 95,000 lines</p> <p>DMS SuperNode SE NA006 All PCLs</p>	<i>Now</i>

The System Load Module (SLM) stores office images and is used to load new software or stored images into the Computing Module. With both the SLM II and SLM IA replaced by the SLM III, the hardware modules that used to be different for the DMS SuperNode and the DMS SuperNode SE systems are now standardized and expanded, with a simplified upgrade process and enhanced mean time between failure (MTBF) rates.

- Value

➤ **Increases capacity**—The SLM-III’s 1-gigabyte disk drive, which replaces the 600-megabyte disk drive on the SLM II and the 300-megabyte disk drive on the SLM IA, supports a 500-megabyte tape drive. This capacity matches the demands of the Series 60 or 70 processor.
- **Simplifies maintenance**—Elevating both the SLM II and SLM IA to a common SLM platform streamlines maintenance procedures involving the SLM, and can simplify the inventory strategy for sparing.
- **Maintains flexibility**—The 250-megabyte tapes from SLM II and SLM IA can continue to be used on the SLM III (of course, the new 500-megabyte tape format can be read on the SLM III only).

Drivers

Wire center consolidations, Advanced Intelligent Networking and ISDN deployment, plus the expanded capabilities of PCLs have contributed to the size of Computing Module loads, which, in turn, place new demands on some existing SLM equipment. The SLM III and its planned enhancements will meet and exceed the larger capacity requirements.

Transition Plan

NT9X44AD now ships with all initial systems and replaces SLM I, IA, and SLM II (NT9X44AB).

DMS SuperNode: NT9X44AD is required for memory configurations greater than 240 megabytes or for a DMS SuperNode with more than 95,000 lines.

DMS SuperNode SE: NT9X44AD is required for memory configurations greater than 145 megabytes. In NA006, it is required for all PCLs.

Series 60 Processor	Prerequisite for:	Available
NT9X10AA	<i>None currently established</i>	<i>Now</i>

The Series 60 is the current baseline processor for the DMS SuperNode and DMS SuperNode SE systems. Equipped with “burst-mode” memory access, the Series 60 offers 10 percent greater real time capacity than the Series 50—and can provide three times greater memory capacity than the Series 50 (in NA005, this processor supports up to 608 megabytes on the DMS SuperNode; up to a maximum of 480 megabytes on the DMS SuperNode SE).

Nortel’s portfolio of BRISC processors—the Series 50, Series 60, and Series 70/70 EM—offers powerful options for achieving significant network growth today—and even greater increases in the future. These three options set the standard for high-capacity, robust processors that meet the subscriber service demands of the late 1990s.

Value

- **Offers real time capacity gains**—to position an office for flexible advanced services delivery, improve office recovery times should a system restart or power outage occur, and offer productivity gains through quicker DMS Maintenance and Administration Position (MAP) response times.
- **Expands memory addressing capacity**—so network providers can respond confidently to rapid expansion and plan a strategy for long-term feature growth.
- **Extends latest computing technology**—Network providers can benefit immediately from industry-leading enhancements. From enhanced error checking to refined noise immunity, this processor meets central office requirements for rapid feature deployment through standardized software loads.
- **Eliminates service disruption**—Series 50-based DMS SuperNode systems can be converted to the Series 60 through a “synch-compatible” upgrade procedure that replaces the 24-Megabyte Memory Cards with 96-Megabyte Memory Cards—without service disruption to established calls.

Drivers

This BRISC-based option enables network providers to keep pace with ever-expanding demands for new features and capabilities. The Series 60 represents an incremental “next level” of computing power to ensure the DMS switching system accesses, processes, and transmits information as quickly and efficiently as possible. This is especially important for middle-to-large size offices making the shift to network-based features (such as local number portability) and deploying new complex services (such as National ISDN-2/3).

Transition Plan

The Series 60 option is recommended for all new installations to support a larger memory capacity, enabling smooth growth for emerging services. This processor requires use of 96-Megabyte Memory Cards (NT9X14EA, only), the NT9X26EA Remote Terminal Interface (RTIF), and NT9X12AD port cards.

For More Information

- *Series 60—A Powerful New Option in BRISC Processing; Product/Service Information* bulletin (50084.16)

Series 70 Processor	Prerequisite for:	Available
NT9X10BA	NA005 CM loads greater than 608 megabytes, or exceeding the real time of the Series 60	Now

By satisfying the real time requirements and performance demands of larger offices, the Series 70 and the Series 70 EM (see next) meet the challenges of large-scale deployment of Advanced Intelligent Networking, National ISDN-2/3, and continued wire-center consolidations. With NA005, NT9X10BA supports up to 736 megabytes of memory—5.5 times the capacity of the Series 20—on the DMS SuperNode and up to 704 megabytes on the DMS SuperNode SE.

Transition Plan

By 1Q98, DMS-100/200 DMS SuperNode and DMS-100/200 DMS SuperNode SE offices with the Series 70 Processor (NT9X10BA) are scheduled to be field-upgraded to the Series 70 Extended Memory (NT9X10CA) processor, discussed next.

Series 70 Extended Memory	Prerequisite for:	Available
NT9X10CA	NA007 CM loads greater than 608 megabytes, or exceeding the real time of the Series 60	LTD:3Q97 GA: 4Q97 NA007

To meet the expanding real time requirements of large, feature-rich offices, the on-board memory capacity of the Series 70 processor is planned to double from a maximum of 256 megabytes to 512 megabytes. This Series 70 Extended Memory (EM) option helps keep on-board software transactions and backplane communications at peak performance rates.

The Series 70 EM uses the most advanced Application-Specific Integrated Circuit (ASIC) and innovative chip designs for enhanced computing power and state-of-the-art noise immunity.

Built on a 60-megahertz processor, the Series 70 EM supports two 8-kilobyte cache memories; two memory management units (one for code and one for data); and 512 megabytes of high-bandwidth, interleaved dynamic random access memory, organized into sixteen 32-megabyte mappable modules.

Value

- **Increased capacity**—Expanded memory addressing and extended processing capacity enhance average call-processing times and dramatically shorten the time needed to return a system from simplex mode to full duplex operation.
- **Enhanced reliability**—For increased immunity from memory errors, an Error Detection and Correction (EDAC) function checks parity throughout the on-board memory continuously and corrects corruptions automatically.
- **Simplified upgrade**—Only the processor circuit pack and the RTIF (Remote Terminal Interface) paddleboard are changed to upgrade from Series 60 to Series 70 EM. If the office already has a BRISC processor running on an NA007 software release or higher, then a software upgrade is not required, and the hardware upgrade can be completed with a NoRestartSWACT (switch of activity).

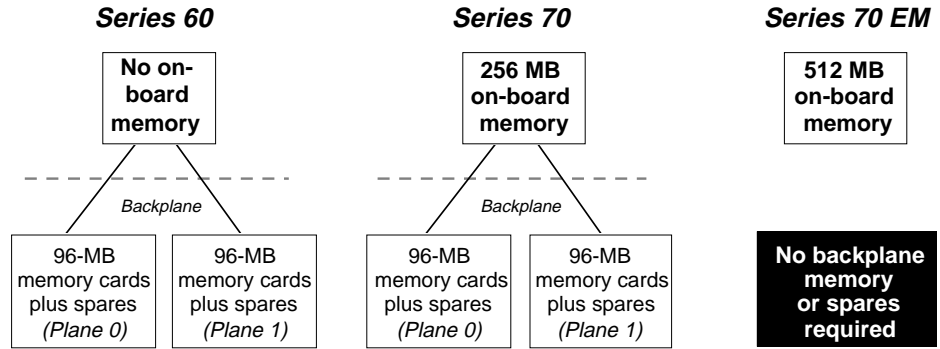

The Series 70 EM Simplifies Upgrade, Sparing, and Maintenance Procedures

Drivers

Near-term dynamic data growth, service penetration, and network node consolidation have the potential to push memory requirements in large offices towards the 256 megabyte maximum supported (in NA006) by the Series 70. The ‘Extended Memory’ option doubles the memory available on the processor and maintains the real time performance for the Series 70 processor at 1.6 times that of the Series 60.

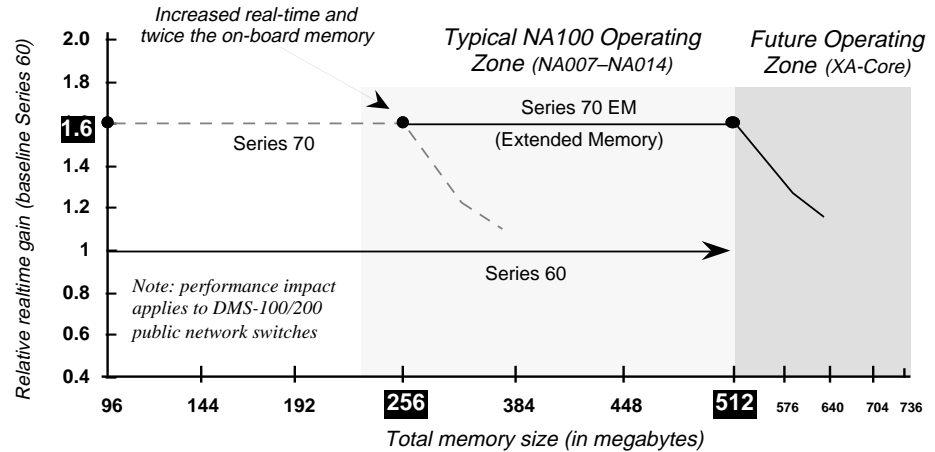

The Series 70 EM Provides Highest Single-Processor Performance

Transition Plan

The optional Series 70 Enhanced Memory processor is planned to have Computing Module software support in PCLs built from NA007 and be generally available in 4Q97. There are no currently established requirements involving the Series 70 EM; it is only required for switches whose Computing Module load exceeds 608 megabytes or whose real time demands exceed the Series 60. The Series 70 EM is ideal for switching offices with large line/trunk configurations or deploying high-capacity services such as Local Number Portability, Advanced Intelligent Networking, or National ISDN-2/3.

This processor does not need 96-Megabyte Memory Cards (NT9X14EA) except when the DMS SuperNode memory requirements exceed 512 megabytes.

For More Information

- *Feature Planning Guide 1997-1998*; pages 36 and 48 (500004.11 Issue 17)
- *Series 70 Extended Memory Option Boosts Performance*; *Product/Service Update* article (50049.17/02-97)

Extended Architecture (XA) Core	Prerequisite for:	Available
	<i>None currently established</i>	LTD: 2H98 GA: 2Q99

In response to network provider requests for the power and flexibility to provision emerging real time-intensive services, a new DMS-Core design is currently under development. The Extended Architecture (XA) Core is a single shelf that will replace today's Computing Module and system load module shelves to permit memory and processor elements to be simply added on, incrementally, as the service provider's network grows. This efficiency minimizes costs associated with incremental capacity management.

With the Extended Architecture Core, a network provider can respond more quickly than ever to market changes with minimal incremental cost and effort to expand Computing Module capabilities.

Simply add a circuit pack to upgrade memory or real time

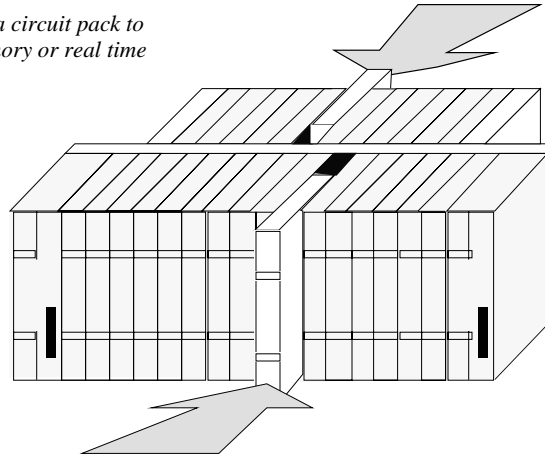

XA-Core Design Permits Circuit Packs to be Inserted into Both Front and Back of Shelf

Value

- **Provides a high-capacity platform**—Real time capacity and memory are scaleable by the addition of processor elements and shared memory modules. With future enhancements, this option could offer as much as a sixfold capacity gain over the Series 70—within the engineering limits of other DMS SuperNode components—and grow memory up to 2 gigabytes of duplicated memory.
- **On-demand capacity growth**—To meet application requirements, the network provider simply inserts an additional processor for higher capacity and real time. This saves time and expense over replacing an entire processor assembly: once the initial XA-Core processor is installed, it stays in use as additional processors are added.

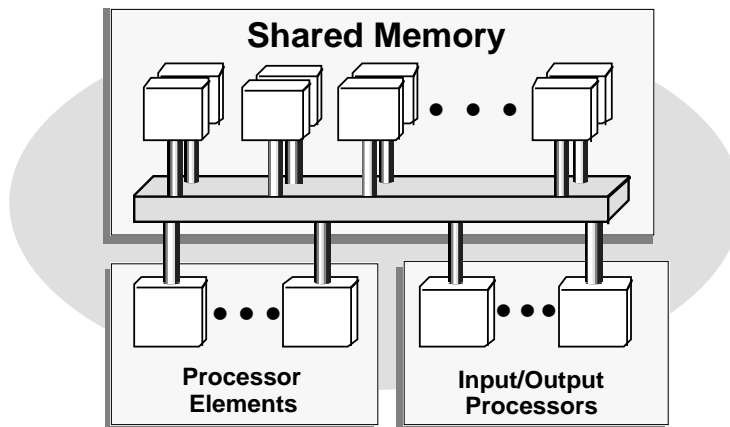

The New Core's Modular Design Helps Lower Cost of Ownership

- **Enhances switch performance**—In addition to providing “hot” backup, spare processor packs actively share the processing load. This dynamic load balancing helps boost the processing capacity to a level many times that of a single processor.
- **Helps generate additional revenue**—The XA-Core offers solutions that help network providers improve responsiveness to changing network demands and reduce operating costs through nodes with larger line sizes and expanded feature sets. To cut the time to market for new services, and to significantly extend service penetration, the XA-Core will expand the scope of processing capacity many times that of any existing processor—well in excess of any currently projected demand.
- **Offers greater reliability**—Since there are multiple processors, the switch can still retain full call functionality even during multiple simultaneous processor faults. To enhance the system’s fault tolerance and survivability, the XA-Core features leading-edge circuitry, detectors, and diagnostics—plus enhanced data security through use of a fault-tolerant file system (FTFS). The new core also provides a unique checkpoint mechanism that can undo erroneous transactions to eliminate the transient effects of a failure and support a no-loss recovery.
- **Helps lower cost of ownership**—The XA-Core offers the next generation of processing power and flexibility while protecting existing investments such as Message Switches, Enhanced Network (ENET), Peripheral Modules, and the other DMS SuperNode components. The new DMS Core’s modular design permits flexible expansion through small incremental additions instead of processor replacement, thus protecting the investment for the initial processing elements.

Drivers

Large wire center consolidations, extensive tandem switching, and mass deployment of Advanced Intelligent Networking-based services represent a sampling of the many pressures that can be addressed by multi-processing solutions in switching nodes. Multi-processing technology—as opposed to the present single-processor approach—significantly simplifies processor upgrades, while lowering capital and operating costs.

Transition Plan

The XA-Core, intended for large offices, replaces the existing processor, memory, and system load modules of the DMS SuperNode. This new core is planned to be introduced in two phases:

- ◆ Release 1 is scheduled to be delivered in 2H98, with “1+1” processor elements (one active processor with one hot spare) operating serially and 512 megabytes of duplicated memory. Its real time capacity is anticipated to be 1.4 times greater than the Series 70 processor.
- ◆ Release 2 is planned for delivery in 2Q99, with “3+1” processor elements (three processors with one active spare) operating in a multi-processing environment. Equipped with 640 megabytes of duplicated memory, this release is expected to provide 2.3 times the real time capacity of the Series 70 processor.

Message Switch (MS)

Internal messaging races through a high-speed fiber-optic system.

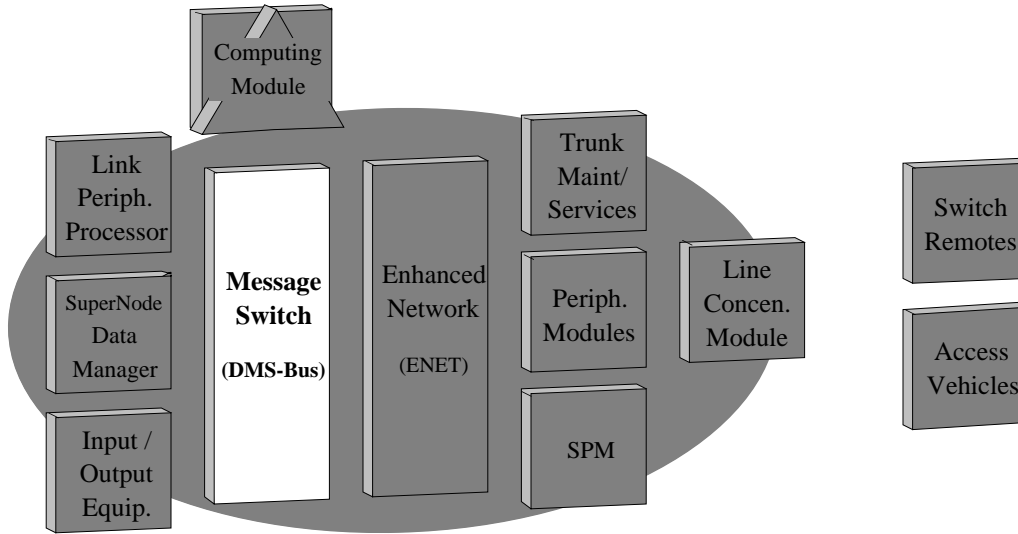

Fiber Optic Links Provide Enhanced Flexibility and System Performance

Hardware	Page
Digital Phase Lock-Loop Clock Card	19

HIGH-THROUGHPUT FREES UP THE COMPUTING MODULE

The DMS SuperNode architecture is designed around a distributed processing strategy, allowing numerous software processing tasks to be shared among various components. This relieves the Computing Module from the overhead of many routine call processing, maintenance, and supervisory tasks.

The key to efficient distributed processing is a messaging transport that permits processors in various hardware components to communicate quickly over an intelligent, self-governing bus. The DMS-Bus is a high-speed optical system, consisting of duplicated Message Switches, that supports sophisticated peer-to-peer communications among components of the DMS SuperNode.

This 32-bit wide, 128-megabits per second bus system can handle more than 125,000 messages

per second with a port-to-port delay of less than 100 microseconds. Simplified interfaces enable the duplicated Message Switches to reliably synchronize the DMS SuperNode system with Stratum 1, 2, and 3 sources.

NEW INTERFACE CARDS

New interface cards for the Message Switch that offer higher bandwidth and expanded performance are currently under development on behalf of specific products detailed in this document:

- ◆ A new Computing Module-side interface for use with XA-Core (see pages 16 and 17). This replacement of the current Compute Module Interface Circuit (CMIC) card supports high-throughput OC-3 links.
- ◆ A new peripheral-side interface for use with the fault-tolerant version of the SuperNode Data Manager (SDM; see pages 68 to 71). This interface links operations, administration, maintenance, and provisioning (OAM&P) applications on the SDM directly to the Computing Module over high-capacity DS-512 links.

SINCE THE PREVIOUS EDITION . . .

The following—discussed in the previous issue of the *DMS-100/200 Hardware Planning Guide*—is now available as an integral part of the DMS-100/200 portfolio of products.

16-Megabyte Processor	Prerequisite for:
NT9X13DD	All PCLs

Today, NT9X13DD ships with all initial DMS SuperNode systems and with expansions in existing offices. As of NA004, the Message Switch requires a minimum of 16 megabytes, which can be through either of the following configurations:

- ◆ NT9X13DD 16-Megabyte Processor, or
- ◆ NT9X14DB 24-Megabyte Memory Card (this is only available with an existing NT9X13DC processor).

The version of the 16-Megabyte processor that is now a baseline requirement for all DMS SuperNode SE systems is the NT9X13NA.

The development of the following, discussed in the previous issue of the *DMS-100/200 Hardware Planning Guide*, has been deferred.

Direct DS-1 Synchronization Interface	NT9X54AE
---------------------------------------	----------

PLANNED ENHANCEMENT

Digital Phase Lock-Loop Clock Card	Prerequisite for:	Available
NT9X53AD	<i>None currently established</i>	<i>Now</i>

For enhanced system operation, NT9X53AD provides a dual-frequency single-oscillator clock system to fine-tune the node-wide alignment of clock signals.

- Value**
- **Enhances switch performance**—The diagnostic circuitry of the single-oscillator clock system enhances fault detection and trouble isolation, to minimize the possibility of outages. Re-engineered clock and frame pulse error checkpoints improve the detection of corrupted or degraded signals.
 - **Refines “synch” generation**—The clock’s design reduces the probability of phase shift or phase jitter. The smallest detectable phase error is around 30 nanoseconds compared to near 100 nanoseconds in the existing clock card.

Drivers

As network providers introduce more and more digital services, the precise synchronization of digital signals throughout each network node becomes increasingly important. The more robust Dual Phase Lock-Loop Clock card offers enhanced synchronization features for the DMS SuperNode.

Transition Plan

NT9X53AD replaces the two-oscillator clock system (NT9X53AC), and ships after 4Q95 with all initial systems and with expansions in existing offices.

Enhanced Network (ENET)

A non-blocking, junctorless time switch that offers widespread access from narrowband to wideband.

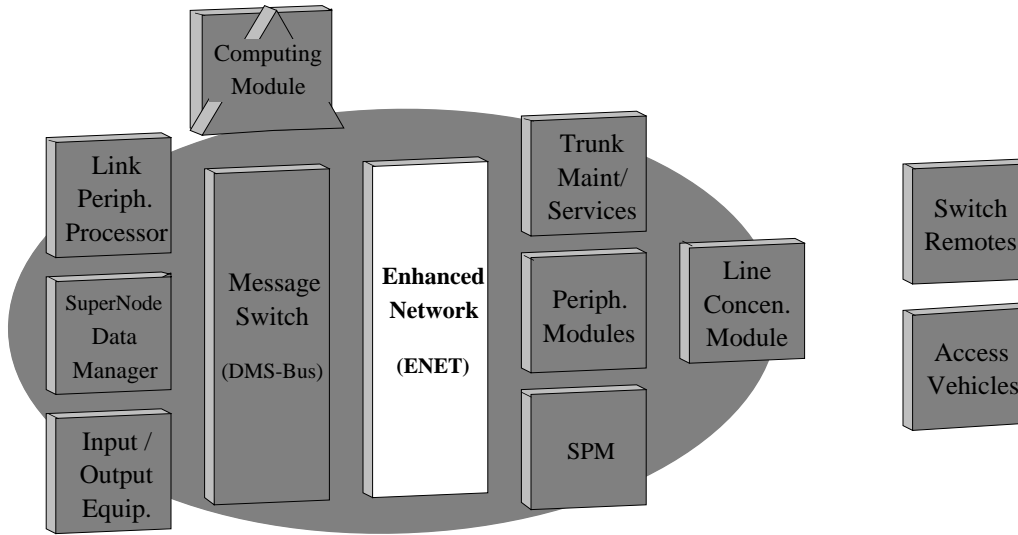

ENET Offers a Powerful Switching Matrix in a Small Footprint

Hardware	Page
Processor Upgrade	22
DMS SuperNode SE Upgrade	23

IMMEDIATE OAM&P AND PERFORMANCE ADVANTAGES

ENET offers significant benefits, including reduced power consumption, footprint, and other operations, administration, maintenance, and provisioning (OAM&P) advantages.

This switch fabric’s unique design offers significant operating cost savings in an environment where adds, moves, and changes are prevalent due to such market forces as Internet access and loop unbundling.

ENET dramatically reduces the number of cables once required to connect network modules, and provides greater reliability and demands less engineering and maintenance attention than traditional junctor systems. Fiber-optic links provide additional flexibility, reliability, and system performance.

A key advantage of ENET is its simple, straightforward engineering. Unconstrained by traffic and load balancing, provisioning is based only on peripheral-link terminations.

Non-Blocking Architecture

With the capacity to support up to 128,000 duplicated DS-0 channels, the ENET’s single-stage architecture guarantees a dedicated path for each call, making it a truly non-blocking network. This eliminates the need to balance traffic loading or traffic mix across the matrix, improves reliability and customer satisfaction, and simplifies operating procedures. If a fault is detected on a connection path, the ENET design also enables straightforward, cost-effective diagnostics, since the path between any two input channels is always the same.

Impressive Reliability

ENET delivers a fully redundant subsystem and the robustness only available through state-of-the-art digital technology. 10⁻¹² bit-error-ratio performance enables significantly enhanced diagnostic/data-grooming capabilities and reduced customer complaints. Maintenance actions per 10,000 channels average below 1.3 unscheduled activities per year. Enhanced bit-error-rate testing (BERT) capabilities improve system reliability and enable craft personnel to more quickly and accurately pinpoint any source of bit errors in the system.

Greater Flexibility

Simple engineering rules permit the flexible ENET to serve in a variety of ever-changing configurations. It requires neither traffic balancing on peripherals nor load balancing across the network matrix. While supporting traditional DS-30 copper links, the ENET also offers DS-512 fiber links—to permit as much as a 3200-foot reach to a peripheral (with no shielding required) along with subsequent gains in transmission clarity, low error rate, and reduced facilities costs. This network supports unlimited nail-ups and cross-connects with no traffic degradations.

Ready for the Future

ENET gracefully supports sophisticated digital services and offers easy migration to residential broadband. Since it was optimized for fiber interfaces from the beginning, this switch fabric is the preferred platform for optics-based, network-level transports and services. For example, ENET is needed to support direct optical interfaces (such as OC-3) to the DMS system with the new SPM (discussed later in this document).

	present	3Q97	4Q97	1Q98	2Q98	3Q98	4Q98	beyond
Processor Upgrade	◇ NA006							
DMS SuperNode SE Line Upgrade								

◇ = Significant new prerequisite involving this hardware. See text in this chapter for details.

Planned ENET Enhancements

PLANNED ENHANCEMENTS

Processor Upgrade	Prerequisite for:	Available
NT9X13KA	NA006 All PCLs, for offices with ENET	Now

Beginning with NA004, ENET processor memory expands to 16 megabytes (up from 4 megabytes), providing more than sufficient support for predicted growth.

Value

- **Provides the capacity to support future services**—This expansion supports the continuous switch operating system enhancements such as the Enhanced One Night Process, robustness features such as Adaptive Routing (for intra-switch messaging), and planned SONET access technologies.
- **Accommodates both processors in transition period**—So the network provider can introduce the new hardware gradually, instead of in a cutover, the new NT9X13KA processor can coexist with the earlier NT9X13FA in NA004 and NA005. In this same time period, shelf extensions with NT9X13KA can operate in existing NT9X13FA-based configurations. Also, the DMS Maintenance and Administration Position (MAP) and associated maintenance procedures support both processors until NA006.

Drivers

Deployment of wideband, ISDN, and other network-demanding services has caused the memory requirements on the ENET processor card to continually increase since its introduction in 1991. In concert with new, rigorous memory management enhancements, this hardware upgrade provides the capacity to support scheduled enhancements in robustness and revenue-generating features.

Transition Plan

As of NA006, all PCLs require an upgrade of the ENET processor to the NT9X13KA, which replaces the 4-megabyte NT9X13FA ENET processor.

DMS SuperNode SE Line Upgrade	Prerequisite for:	Available
	NA006 Port capacity beyond 16,000 channels	<i>Now</i>

As a mid-range, high-functionality server, the space-saving DMS SuperNode SE supports a broad range of revenue-generating services for startup or small line/trunk size offices. As the office grows and the single cabinet's Single-Shelf ENET reaches its maximum, network capacity and revenue-generating potential can be increased by a smooth, cost-effective transition to the standard DMS SuperNode platform.

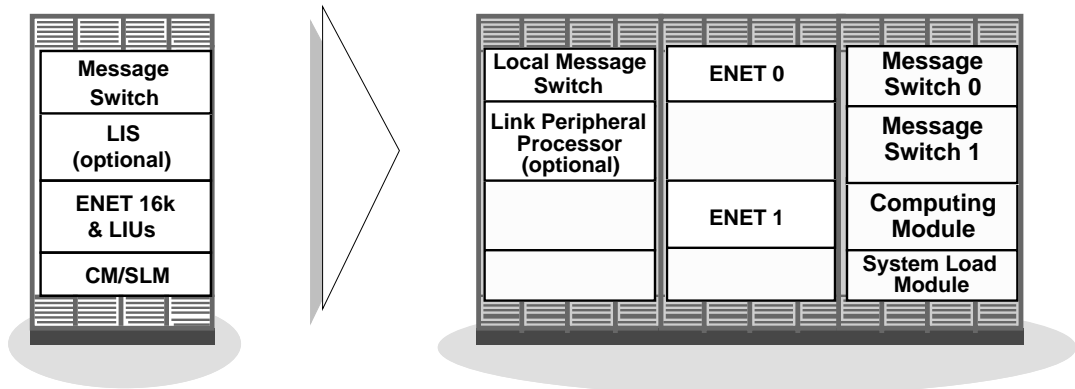

DMS SuperNode SE configured with 16,000 channels

DMS SuperNode initially configured with 32,000 channels—with growth potential to 128,000 channels.

Value

- **Gain the full revenue-generating potential of the DMS system**—When growth in network trunks, CCS7 links, subscriber lines, and system components exceeds the DMS SuperNode SE's eight Single-Shelf ENET ports, the migration to a standard DMS SuperNode (offering 20 ports) opens the door to new growth capacity and revenue potential. The upgrade accommodates all current and future DMS SuperNode enhancements and new system components—such as additional LPPs to support operator services, additional signaling links for enhanced Local Number Portability, and an ENET-based switch matrix to replace a junctor network (JNET). Cutover procedures minimize any service disruption during this transition.
- **Upgrade now**—This migration procedure was previously announced as scheduled for general availability in the NA008 time period. To address the concerns of network providers, Nortel has accelerated the availability of this solution to NA006, available today.

Drivers

Many offices have experienced significant growth in network trunks from the continuing upsurge in calls with long holding times due to increasing Internet and work-at-home data access. At the same time, unexpected developments, such as the arrival of a new business park in the serving area, can raise requirements for subscriber lines beyond originally projected levels. The cost-effective migration to a standard DMS SuperNode enables the network provider to stay ahead of projected office growth and to capitalize fully on current market opportunities.

Trunk Maintenance / Services

A centralized subsystem hosting numerous testing and service circuits.

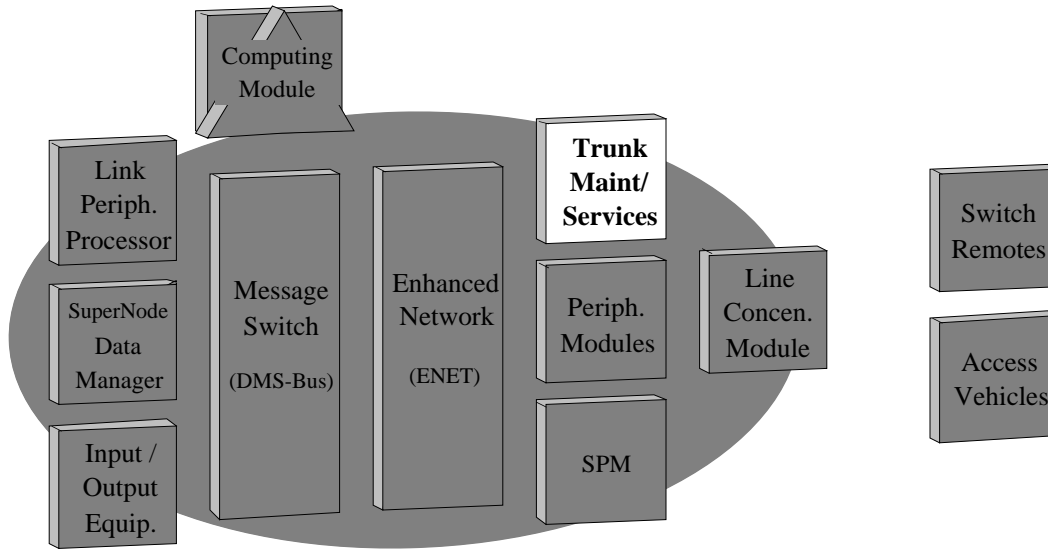

A Miscellaneous Group of Testing and Audio Service Capabilities

Hardware	Page
Metallic Line Test Access Consolidation	26
Enhanced Digital Test Unit (EDTU)	27

This miscellaneous hardware group includes specialized circuitry for:

- ◆ Special digital audio features.
- ◆ Line/trunk testing and troubleshooting equipment.

This hardware’s multi-functional shelves provide Peripheral Module service circuits for such audio features as recorded announcements and teleconferencing, as well as a variety of line and trunk testing circuits.

This family of hardware is continuously evolving to enhance flexibility, capacity, and the life-cycle cost of DMS SuperNode operations.

ADDITIONAL EDRAM CAPABILITIES WITH NA005

Beginning with NA005 PCLs, the Enhanced Digital Recorded Announcement Machine (EDRAM), NT1X80, extends its maximum announcement length from 4 minutes up to 16 minutes over its 30 announcement channels. Also, this easy-to-customize digital announcer now supports multilingual time-and-charges announcements.

SINCE THE PREVIOUS EDITION . . .

The following four products—discussed in the previous issue of the *DMS-100/200 Hardware Planning Guide*—are now available as integral parts of the DMS-100/200 portfolio.

Enhanced DRAM (EDRAM)	Prerequisite for:
NT1X80AA	<i>None currently established</i>

NT1X80 replaces the Digital Recorded Announcement Machine (DRAM, NT1X75/76/79, which has been manufacture discontinued) and ships with all initial systems and with expansions in existing offices.

Conference Trunk Module (CTM)	Prerequisite for:
NT1X81AA	<i>None currently established</i>

NT1X81 replaces the 6-Port Conference (NT3X67, which has been Manufacture Discontinued) and ships with all initial systems and with expansions in existing offices.

Integrated Services Module (ISM)	Prerequisite for:
NTFX40AA (cabinet) / NTFX40BA (frame)	<i>None currently established</i>

The Integrated Services Module (ISM) is a frame and shelf that replaces the Trunk Module (TM) and Maintenance Trunk Module (MTM) to help reduce cost of ownership and enhance system quality. The ISM ships with all initial systems and with expansions in existing offices.

Enhanced Alarm System (EAS)	Prerequisite for:
NT3X82AG/AH and NT3X89AB/CA	<i>None currently established</i>

This alarm subsystem provides split-second notification of a power outage and precise indication of the nature of power problems within the DMS SuperNode equipment.

The development of the following, discussed in the previous issue of the *DMS-100/200 Hardware Planning Guide*, has been manufacture discontinued.

Enhanced Services Testing Unit (ESTU)	
	NT0J42BA and NT0J43AA

PLANNED ENHANCEMENTS

Metallic Line Test Access Consolidation	Prerequisite for:	Available
NTFX40EA (cabinet) / NTFX40FA (frame)	None currently established	LTD: Now GA: 4Q97

To offer metallic testing with high reliability and outstanding ease of use, Nortel consolidated metallic test access modules with associated cabling and cross-connections within the customer's choice of either a standard conventional frame or cabinet. The introduction of a Cabinetized Metallic Test Access (CMTA) Model-B cabinet and a Metallic Test Access Equipment (MTAE) DMS frame greatly simplifies engineering, installation, and maintenance procedures to significantly reduce operating costs.

Value

- **Enhances maintenance procedures**—This modular matrix in the central office lineup provides centralized maintenance for enhanced services (such as National ISDN) and universal digital loop carriers. Reduced cable length is important for accuracy in high-frequency tests and for minimizing the bridge-tap effect. Also, if deployed properly, the new, simplified approach to cross-connects virtually eliminates the possibility of cabling errors.
- **Significantly reduces costs**—This easily expandable cross-connect solution lowers on-going switch life-cycle costs by minimizing costly engineering, installation, and debugging tasks. By offering cross-connections for up to 25,600 lines (depending on remotes and digital loop carriers controlled off the host), each frame or cabinet reduces cabling and space requirements.
- **Streamlines switch installation**—The use of MTAE/CMTA minimizes the number of cross-connections required to be made in the field when installing an initial DMS SuperNode or extension to an existing DMS switch.
- **Offers an open, flexible solution**—The MTAE/CMTA design complies with Bellcore LSSGR requirements in offering metallic test access to world-wide environments using internal or external test heads.

Drivers

Historically, completing cross-connections for metallic test access was a very tedious office operation, prone to error with high engineering and labor costs. This has been streamlined through the introduction of the MTAE/CMTA.

Transition Plan

After 4Q97, the appropriate number of frames or cabinets are scheduled to ship with all initial systems and expansions. These new housings will host equipment already generally available, such as the Wideband Test Access Panel (NT7X76BA) and multiple Metallic Test Access Modules (NT3X09BA). There are no currently established requirements involving the CMTA (NTFX40EA) or MTAE (NTFX40FA).

For More Information

- *DMS-100 SuperNode Metallic Test Access System; Product/Service Information* bulletin (50082.16 Issue 2)
- *New Wideband Test Access Panel; Product/Service Update* article (50028.17/05-92)
- *Wideband Test Access Panel; Product/Service Update* article (50017.17/05-91)
- *DMS-100 ISDN Integrated Testing Rollout; Product/Service Information* bulletin (50082.16)

Enhanced Digital Test Unit (EDTU)	Prerequisite for:	Available
NT4X45AA	<i>None currently established</i>	LTD: Now GA: 4Q97 NA004

To enhance the accuracy and flexibility of trunk and line maintenance functions, the Enhanced Digital Test Unit (EDTU) is being introduced to replace the existing Trunk Test Unit (TTU), Transmission Test Trunk (TTT), and Digital Test Unit (DTU). The EDTU has 4 virtual test units that can be independently configured to perform any of the TTT, TTU, or DTU test functions.

Value

- **Reduces cost of ownership**—The EDTU opens up more room in the Integrated Services Module (ISM) shelf, providing up to an 8:1 reduction in the number of circuit packs required for line and trunk maintenance. Also, the EDTU requires significantly less power for equivalent functionality.
- **Enhances accuracy and reliability**—The EDTU provides expanded testing functionality over the current TTT and TTU. In addition, the effective test capability per channel increases from 50 to 100 percent due to the faster execution of tests. The EDTU also offers increased reliability due to the reduced number of components.

Drivers

In today's competitive market, consolidation of switch functions onto a smaller footprint becomes increasingly important. The EDTU provides space savings, reduces power consumption, and offers ongoing operating savings—combined with improved performance and increased flexibility.

Transition Plan

The optional EDTU can reside in both the existing Maintenance Trunk Module (MTM) shelf and the new Integrated Services Module (ISM) shelf. It is fully compatible with existing TTT, TTU, and DTU equipment. The TTT, TTU, and DTU hardware will be manufacture discontinued following the general availability of the EDTU, which will be used for all initial and extension office requirements.

Minimum software level: NA004.

Peripheral Modules (PMs)

Flexible, high-capacity analog and digital bridges between the DMS SuperNode and subscribers.

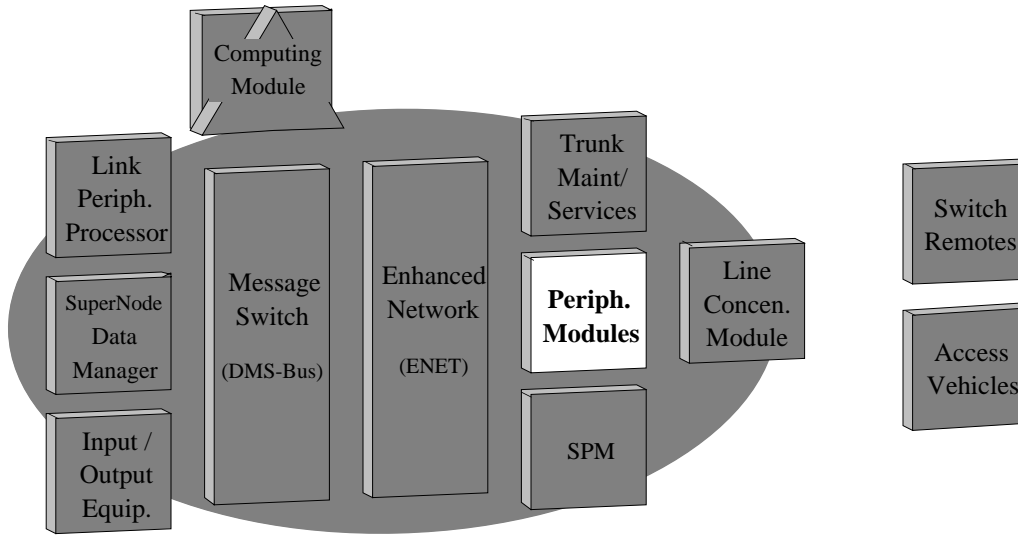

***XPMs and SCMs Handle
Voice and Data Traffic Efficiently***

Hardware	Page
Enhanced D-Channel Handler	32
Peripheral/Remote Loader	33
16-Megabyte Processor	34
Expanded SCM-100A (ESMA)	36
Integrated Channel Bank on ESMA	38
MBS on Generic TR-303	39
Global Tone Receiver	39

HIGH EFFICIENCY AND FLEXIBILITY

Peripheral Modules handle voice and data traffic to and from trunks and lines. The integrated line cards and trunk circuit packs that reside in Peripheral Modules—and upgraded Extended Peripheral Modules (XPMs)—handle traffic through signaling supervision and superior message-handling control operations. Standard DS-1, DS-30, and DS-30A links offer flexible connectivity to digital or analog transmission facilities, maintenance circuits, subsidiary Peripheral Modules, or other switching offices.

This chapter also discusses Subscriber Carrier Modules (SCMs) that integrate traditional and next generation digital loop carriers (DLCs) and remote digital terminals (RDTs) through proprietary and industry standard (TR-08 and TR-303) interfaces.

XPM PLUS

In response to network provider requests for the capacity and power to provision today’s sophisticated new services, the current Series 2 (XPM/SCM) peripherals have been enhanced by a new processor, the XPM PLUS.

The XPM PLUS program enables network providers to keep ahead of the demand for new revenue-generating features, such as National ISDN, CLASS, and CCS7-based services. By supporting more calls and supplying greater memory, XPM PLUS can help increase revenue potential, lower operating costs, and speed the introduction of new services.

XPM PLUS offers about 60% more memory than earlier hardware and more real time capacity (20% to 30% for three-processor Peripheral Modules and 60% to 65% for two-processor Peripheral Modules). The Unified Processor (UP, NTMX77AA) and the Bus Terminal Paddleboard (NTMX71AA) circuit packs replace existing processor and memory, combining the functions of the:

- ◆ PM Processor (NT6X45)
- ◆ Signaling Processor Memory (NT6X46)
- ◆ Master Processor and Memory (NT6X47)

Thus, four to five circuit packs combine into one—for better space utilization, reduced power requirements, improved reliability, and lowered life-cycle costs due to sparing.

The following table identifies the hardware required as part of an upgrade to the XPM PLUS.

Component	Requirement
All peripherals	NT0X50 must have a metal faceplate
SMS	NT6X80BB and NT6X86AB
ISDN peripherals	<ul style="list-style-type: none"> • NTBX01AB or higher Enhanced ISDN Signaling Preprocessor (EISP) • NTBX34BC (ISDN LCM Processor) <p><i>For National ISDN-2/3 features:</i></p> <ul style="list-style-type: none"> • NTBX02BA Enhanced D-Channel Handler (EDCH)

NA004 (all PCLs)	NA005 and later
All PMs must have XPM PLUS, <i>except:</i> the Digital Trunk Controller, Subscriber Carrier Module-100S (SMS), TOPS Message Switch, and Subscriber Carrier Module-100S Remote.	All PMs require the XPM PLUS load.

SINCE THE PREVIOUS EDITION . . .

The following four products—discussed in the previous issue of the *DMS-100/200 Hardware Planning Guide*—are now available as integral parts of the DMS-100/200 portfolio.

Message Protocol and Tone Generator	Prerequisite for:
NT6X69AD	NA002 A range of call display features

This space-saving circuit pack supports the advanced messaging and diagnostics demanded by strategic subscriber-based listing and editing features, such as Spontaneous Call Waiting Display, Visual Screen List Editing, Analog Display Services Interface (ADSI), and more. In one circuit pack this card provides tone generation circuitry as well as providing an interface for control messages and the parallel speech bus.

Enhanced Time Switch (ETS)	Prerequisite for:
NTAX78AB	NA003 Digital Test Access: SCM-100A with AccessNode and ESMU with DMS-1 URBAN
	NA004 Generic TR-303 remote digital terminal on the SCM-100A (SMA)
	NA006 SMA (but not ESMA)

NTAX78AB extends support of Digital Test Access capabilities to Basic Rate Interface (BRI) ISDN lines terminating on the DMS-1 Remote Carrier URBAN. As of NA003, NTAX78AB replaces NT6X44AB in offices that will implement Digital Test Access for:

- ◆ Expanded Subscriber Carrier Module-100 URBAN (ESMU)
- ◆ Subscriber Carrier Module-100A (SMA) with AccessNode

As of NA004, SMAs interfacing generic TR-303 compliant remote digital terminals require the NTAX78AB. As of NA006, all SMAs (but *not* ESMAs) will require the NTAX78AB.

Enhanced SCM-100U (ESMU)	Prerequisite for:
	ISDN and Meridian Business Set support to the DMS-1 URBAN

The ESMU delivers ISDN and Meridian Business Set features to the DMS-1 URBAN, the industry's first TR-08 remote digital terminal to provide these services in addition to traditional POTS and special services. The ESMU replaces the SMU, and ships with all initial systems and with expansions in existing offices. Since NA002, ESMUs require the use of the Enhanced D-Channel Handler. The use of Digital Test Access on Basic Rate Interface (BRI) ISDN lines requires the Enhanced Time Switch (NTAX78AB; see above).

Subscriber Carrier Module-100A (SMA)	Prerequisite for:
	BCS36 Integration of AccessNodes
	NA004 Integration of AccessNodes and RDTs compliant with TR-303

The Subscriber Carrier Module-100A (SMA), a 20 DS-1 based peripheral, has provided digital integration for AccessNodes since BCS36. In NA004, SMA peripherals also simultaneously support generic TR-303 RDT integration. The SMA will be phased out of production for new shipments in favor of the 48 DS-1 based Expanded SCM-100A (ESMA).

The development of the following two products, discussed in the previous issue of the *DMS-100/200 Hardware Planning Guide*, has been deferred.

Peripheral/Remote Loader-64	NT7X05BA
------------------------------------	----------

DS-1 Interface Card	No number
----------------------------	-----------



	Present	3Q97	4Q97	1Q98	2Q98	3Q98	4Q98	beyond	
Enhanced D-Channel Handler (EDCH)									➤
Peripheral/Remote Loader-16									➤
16-Megabyte Processor	◊ NA006								➤
Expanded SMA-100A (ESMA)									➤
Integrated Channel Bank on ESMA		LTD	GA NA008						➤
MBS on Generic TR-303		LTD	GA NA008						➤
Global Tone Receiver	GA								➤

◊ = Significant new prerequisite involving this hardware. See text in this chapter for details.

Planned New Peripheral Module Enhancements

PLANNED ENHANCEMENTS

Enhanced D-Channel Handler	Prerequisite for:	Available
NTBX02BA	NA002 Enhanced SCM-100U (ESMU)	Now
	NA003 XPM PLUS upgrades	
	NA005 All ISDN packet data peripherals	

The current D-Channel Handler (DCH) provides ample memory and processing power for National ISDN-1 requirements. As National ISDN evolves, the additional features will require a higher-capacity DCH. The Enhanced D-Channel Handler (EDCH) is essential for the continued rollout of ISDN features and enhancements in support of National ISDN-2 and National ISDN-3 implementation. The EDCH's 300% expansion in memory, along with the 20-25% increase in real time processing, reduces hardware requirements for X.25/X.75/X.75' ISDN packet switching.

Value

- **Delivers the power needed for emerging ISDN packet standards**—The EDCH provides four times the memory and a 20 to 25 percent real time capacity increase over the existing D-Channel Handler.
- **Reduces operating costs**—The EDCH's single-pack design replaces the functionality of four or five packs, which offers improvement in space and power consumption. Its source code patching capability and integrated maintenance features also contribute to lowering operating costs.
- **Simplifies ISDN OAM&P**—The EDCH shares common operations, administration, maintenance, and provisioning (OAM&P) with Link Peripheral Processor applications, and integrates all ISDN maintenance features into the DMS SuperNode OAM&P system for support of revenue-producing packet-switching services.

Drivers

Since the introduction of peripherals for ISDN applications, Nortel has continually added the new features requested by our customers. As a result, processors have been enhanced to support these new ISDN features and capabilities. The advanced capabilities of National ISDN-2 and National ISDN-3 packet switching features place new demands on ISDN peripherals. The EDCH offers the processing power to meet and exceed the new memory and real time specifications.

Transition Plan

As of NA002, the Enhanced D-Channel Handler must reside in all ESMUs. As of NA003, the EDCH is part of all XPM PLUS upgrades. Beginning in NA005, NTBX02BA is required in all ISDN packet switching peripherals.

Each peripheral must have XPM PLUS (processor: MTMX77AA or higher) installed that includes the Enhanced ISDN Signaling Processor (EISP, NTBX01AB or higher). *Minimum software level: BCS36.*

For More Information

- *ISDN Packet Service Processors Get a Boost; Product/Service Update* article (50049.17/01-95)
- *Introducing the New Enhanced D-Channel Handler; Product/Service Update* article (50032.17/10-92)

Peripheral/Remote Loader	Prerequisite for:	Available
NT7X05AA	None currently established	Now

The Peripheral/Remote Loader, part of the Peripheral/Remote Loader (PRL) hardware and software program, automates the loading of XPM software for general Peripheral Modules equipped with XPM PLUS. This significantly reduces the time required for loading new XPM software.

Value

- **Reduces operating costs and offers greater service velocity**—Peripheral software upgrades can be completed significantly faster, since new XPM loads can be pre-positioned at any time without having to busy-out any XPM units. A single craftsperson can now perform more software updates within a given time frame, to enhance craft productivity and speed service velocity.
- **Minimizes risk during peripheral software upgrades**—The PRL program reduces the time a peripheral spends in simplex mode during XPM upgrades. For example, a peripheral that formerly operated in simplex mode for 100 minutes during a software upgrade can have that time reduced to around 35 minutes with NT7X05AA.
- **Enhances class of service**—The Peripheral/Remote Loader minimizes recovery time if the peripheral encounters a fault-recovery situation where a software reload is required (15-20% of fault occurrences). Service is restored quickly because reload time in fault recovery or power-up situations is greatly reduced—by as much as 92% when compared to BSC36 (depending on peripheral, configuration, and software load size).
- **Reduces Computing Module real time activity**—XPM software loads into the Peripheral/Remote Loader in background mode and does not compete with call-processing real time resources.

Drivers

The Peripheral/Remote Loader hardware and software program is part of Nortel's continuing commitment to enhance the operation of switch peripherals, maximize in-service time, and lower the cost of DMS SuperNode ownership.

Transition Plan

This circuit pack is an optional card that can be added to a switch peripheral (with an 8-megabyte processor) that has XPM PLUS installed. Please note there are two exceptions:

- ◆ Not planned for SMA and ESMA peripherals.
- ◆ Support for the NTAX74AA processor (load file support only) is scheduled to be available in NA008 (XPM8.1 load).

NT7X05AA does not replace existing hardware. For redundancy, two cards will be required for each Peripheral Module. PRL is intended for load files only and does not include imaging for ISDN peripherals.

Minimum software level: NA004.

For More Information

- *Peripheral Loader Reduces XPM Load Times; Product/Service Update* article (50049.17/01-95)

16-Megabyte Processor	Prerequisite for:	Available
NTAX74AA	NA006 Expanded SCM-100A <i>Another NTAX74AA prerequisite, involving the RSC-S, appears on page 55</i>	<i>Now</i>

This high-performance Peripheral Module processor—calculated to affect only a small percentage of the installed XPM peripherals and RSC-Ss in the field—expands both real time and memory capacity to support the implementation of a peripheral-based Embedded Operations Channel (EOC) protocol stack for the ESMA and SMA. This helps improve the efficiency of host/peripheral communications and provide additional processing bandwidth for expanding EOC applications.

See also “16-Megabyte Processor” on page 55 for information about this processor with the RSC-S switch remote.

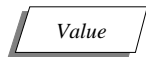

- **Expands revenue potential**—By providing the processing power to support increasingly more complex services, this enhanced peripheral processor helps network providers expand service portfolios with a cost-effective addition to existing equipment. The expanded real time can complete more calls to help the penetration of high-demand services.

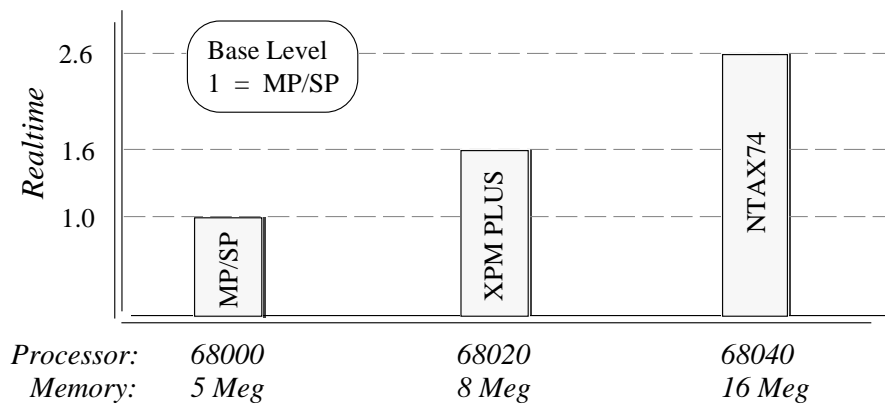

Comparison of NTAX74AA with Previous Processors

- **Differentiates a network provider’s service offering**—The larger memory accommodates larger loads with more revenue-generating services than previously possible—as well as supporting more robustness, performance, and diagnostic features to enhance the quality of service to subscribers.
- **Improves performance for EOC applications**—When used with either the ESMA or SMA, NTAX74AA migrates the Embedded Operations Channel (EOC) protocol stack from the Computing Module to the peripheral to improve real time performance. Because this processor enhances the performance of existing EOC applications and enabling new functions—such as enhanced alarm monitoring, line state monitoring, and database audits—network providers can use the full array of existing and planned EOC capabilities with superior application response times.

- **Minimizes operating costs**—The card's lower power consumption offers long-term cost savings. Its on-board Error Detection and Correction (EDAC) circuitry enhances the mean time between failure rate, lowering the possibility of a service-affecting incident. The expanded capacity can eliminate or defer the need for costly load redistribution of real time- and memory-intensive lines, such as Meridian Digital Centrex or ISDN.

Drivers

Growing demand for Internet access, telecommuting, business voice and data interworking, and other applications that can be offered through National ISDN and Advance Intelligent Networking services has network providers seeking ways to offer these services at business centers, industrial parks, shopping malls, and other developments at ever increasing distances from the central office. NTAX74AA provides the processing power and robustness to extend emerging revenue-generating services.

Access modernization is driving networks toward larger switches with line cards migrating closer and closer to the subscriber. To support the demand for "lineless" switches, with as many as 100,000 subscribers, the 16-Megabyte Processor provides exceptional processing power to support existing and planned applications in the shifting network topology.

Transition Plan

The 16-Megabyte Processor is required in the NA006 time frame to replace the existing processors for ESMA and SMA peripherals for all PCLs.

Any RSC-S with the Peripheral/Remote Loader installed should not upgrade to the NTAX74AA until NA008.

Peripheral Modules using the NTAX74AA 16-Megabyte Processor also require the Enhanced ISDN Signaling Processor (EISP) circuit pack, either NTB01AC or NTB01BA.

For More Information

- *NTAX74AA Processor Boosts XPM Plus Performance; Product/Service Update* article (50049.17/01-96)

Expanded SCM-100A (ESMA)	Prerequisite for:	Available
	NA004 Integration of TR-303 RDTs such as AccessNodes	Now

Nortel’s Expanded SCM-100A (ESMA) bolsters current access modernization by integrating advanced access vehicles—such as the AccessNode and the Cornerstone family of broadband products—to support voice, data, and multimedia services. In addition to delivering a scalable architecture to support complete switching and access solutions from Nortel, the ESMA also provides multivendor compatibility with Bellcore’s TR-TSY-000303 (TR-303) specification.

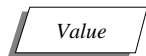

- **Provides a highly flexible interface that goes beyond TR-303**—The ESMA—along with Nortel’s next generation digital loop carrier, the AccessNode—offers enhanced functionality built on a TR-303 base. This fully integrated proprietary interface cuts new feature response time to market; offers cost-saving service adaptive line cards that can be provisioned remotely; supports Meridian Business Set; integrates OC-12 feeders; provides enhanced operations, administration, maintenance, and provisioning; and offers a scalable platform for future services.
- **Offers superior capacity and flexibility**—Accommodating up to 48 DS-1 peripheral links, the high-capacity ESMA offers assignment flexibility and increases the number of concentration options for large remote digital terminals (RDTs) and broadband access systems. For configurations involving a number of smaller RDTs, expanded DS-1 capacity substantially reduces the need for network ports and switch peripherals through concentration at the ESMA.
New support for integrated channel banks (see page 38) expands the ESMA into a multi-interface platform. And there’s no compromise on flexibility: both integrated channel banks and TR-303 RDTs/AccessNodes can be supported simultaneously from the same platform.
- **Expands ISDN capacity**—An ESMA can support any mix of up to eight RDTs without ISDN Basic Rate Interface (BRI) lines, or up to five RDTs with ISDN BRI lines (this capacity is scheduled to expand in NA008 to seven RDTs with ISDN)—with a capacity maximum of 756 National ISDN BRI lines scheduled for NA009. The ESMA’s flexible port assignment feature allows ISDN capacity to be incrementally expanded simply by adding ISDN D-Channel Handler circuit packs.
- **Provides proven TR-303 interoperability**—Nortel leads the industry in demonstrated TR-303 interoperability through live multivendor office trials, on-going interoperability testing with major RDT suppliers, and significant deployment of AccessNode systems. The ESMA continues to provide a comprehensive set of TR-303 service and operations capabilities—including remote provisioning, extensive maintenance/testing options, and sophisticated ISDN services.
- **Supports large RDTs**—The ESMA supports any combination of up to 28 DS-1s and 2,048 lines from a single RDT. This offers traffic and loop concentration options that can significantly reduce facility and switch peripheral operating costs.

Drivers

The Expanded SCM-100A's high-capacity TR-303 interface serves as the premier vehicle for interfacing next generation digital loop carriers, hybrid fiber/coax residential broadband systems, and radio port control units for wireless networks.

As Nortel's TR-303 switch peripheral, the ESMA offers network providers maximum functionality and service velocity in a single-vendor environment, while meeting the key goal of maximum compatibility and interworking of services and equipment in a multivendor environment.

Bellcore's TR-303 offers the basic facility maintenance features already available with TR-08 and adds new capabilities, including detailed alarm reports, remote provisioning, ISDN performance monitoring, ISDN loopback tests, and data link protection switching.

Transition Plan

The Expanded SCM-100A (ESMA) replaces the original version (SMA) in all initial systems and with office expansions. For all new installations, the ESMA is used to integrate the AccessNode and other TR-303 compliant RDTs.

Minimum software level: NA004.

For More Information

- *ESMA Expanded SCM-100A; Product/Service Information* bulletin (50132.16)
- *DMS -100/200 Feature Planning Guide 1997-1998*; "Integrated Switch Access" chapter, pages 69-82 (500004.11 Issue 17)
- *TR-303 Primer; Product/Service Information* bulletin (50042.08)
- *Expanded SCM-100A, Maintenance Manual; Northern Telecom Publications* (297-8263-550)

Integrated Channel Bank on ESMA	Prerequisite for:	Available
	<i>None currently established</i>	LTD: 3Q97 GA: 4Q97 NA008

This ESMA enhancement provides a cost-effective T1/D4 interface for applications with collocated equipment.

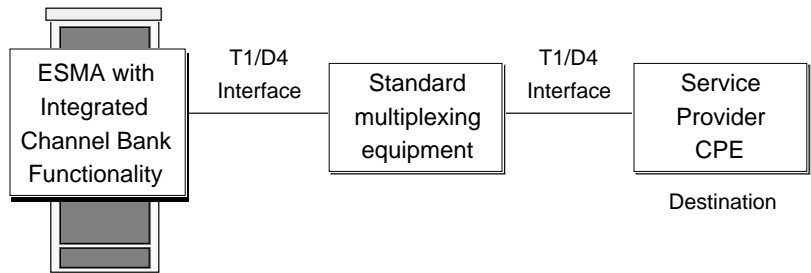

Value

- **Offers cost-effective deployment**—avoids the expense of line cards and lowers access costs associated with line administration for low line size applications.
- **Simultaneously supports a wide range of access applications**—The ESMA’s superior DS-1 capacity and forward-looking architecture enable concurrent support of TR-303 remote digital terminals, AccessNodes, and integrated channel bank applications.
- **Provides service flexibility**—offers greater deployment flexibility when compared to cross-connect solutions. For example, this interface supports multiple directory number hunting so the provider can offer “single number” access.

Drivers

Internet access, work-at-home applications, and unbundled loops as a result of the Telecommunications Reform Act are all contributing to the rise of collocated equipment and associated interfaces. To help reduce the operating costs to maintain these applications, this solution enhances the ESMA platform to support inexpensive basic POTS/RES/Centrex service to small clusters of customers that can be served by a single DS-1.

Applications typically using channel banks for line group termination include small clusters of remote residential lines, Internet Service Provider (ISP) modem pools, and enhanced systems that provide voice mail or automated voice response for customer assistance. This service supports POTS/RES phones and can support Centrex for sites that do not require MBS or ISDN terminals.

Transition Plan

By integrating D4 Foreign Exchange Signaling into the ESMA platform, a channel bank DS-1 can terminate directly to an ESMA DS-1 port—eliminating the need to provision line cards in an ISDN Line Concentrating Module (ISDN LCM) to terminate individual DS-0 channels. Also eliminated is the requirement for a digital cross connect to convert the D4 signal format.

For More Information

- *DMS -100/200 Feature Planning Guide 1997-1998*; pages 81-82 (500004.11 Issue 17)

MBS on Generic TR-303	Prerequisite for:	Available
	<i>None currently established</i>	LTD: 3Q97 GA: 4Q97 NA008

This option enables network providers deploying non-DMS next generation digital loop carriers (NGDLC) and residential broadband access systems to support DMS Meridian Business Sets (MBS) line card signaling. Industry-standard TR-303 access protocol transparently extends revenue-generating MBS services to the customer premises.

Value

- **Expands potential subscriber base**—With a minimal investment, popular MBS services can penetrate deeper into existing and new serving areas.
- **Reduces capital and operating costs**—This solution eliminates the need to install and maintain an MBS channel unit at the central office terminal (COT) or an MBS line card in the Line Concentrating Module (LCM).
- **Protects Existing NGDLC Investments**—Avoids the expense of deploying multiple access vehicles while supporting ubiquitous expansion of MBS-specific centrex services.

Drivers

The Meridian Business Set provides single-button access to many DMS-100 switch-based features. NA008 permits ongoing support and growth of MBS services as the access network between the host and MBS terminals evolves.

Transition Plan

To use ESMA MBS/TR-303 access, the remote digital terminal must support the functionality specified by Nortel publication NIS V202-1, *Integrated Digital Loop Carrier Interface Specification for Electronic Business Set Services*.

Global Tone Receiver	Prerequisite for:	Available
NT6X92EA	<i>None currently established</i>	LTD: <i>Now</i> GA: 3Q97

A *tone receiver* detects incoming dual tone multi-frequency (DTMF) tones from a subscriber's phone set or multi-frequency (MF) tones from an incoming trunk circuit. Nortel is introducing an enhanced version of this function with the new Global Tone Receiver (GTR) to replace the existing Universal Tone Receiver (UTR). The Global Tone Receiver is an Extended Peripheral Module (XPM) based circuit pack that can detect incoming tones on up to 32 Pulse Code Modulation (PCM) channels simultaneously. Its upgraded performance enhances all services, but is especially advantageous for emerging voice-activated dialing services.

Value

- **Improved Performance**—The GTR more accurately and consistently decodes incoming tones from multiple sources. Its advanced design can help the operation of voice-activated dialing services.
- **Universal Applicability**—The Global Tone Receiver—with only one PEC number (NT6X92EA)—replaces all existing versions of the Universal Tone Receiver, both for domestic and international applications.

Drivers

Although the Global Tone Receiver is being introduced to support the growing popularity of voice-activated services, the GTR's enhanced performance make it the tone receiver product-of-choice for all applications.

Transition Plan

The new Global Tone Receiver is fully compatible with the Universal Tone Receiver already in the network. There are no minimum software requirements.

SPM

A next-generation high-speed optical switch peripheral for entry into public data enterprise.

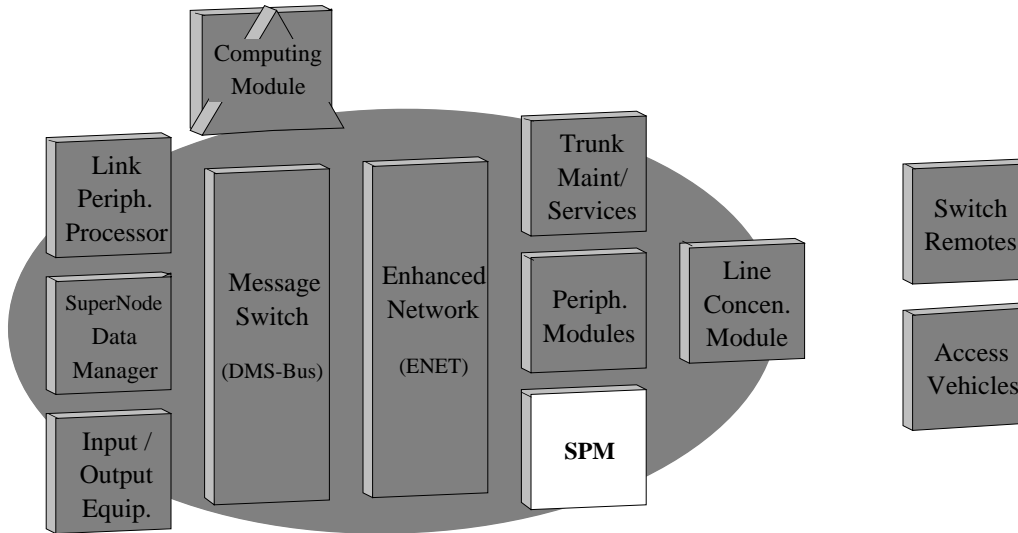

A Multi-Application Peripheral with Wide Bandwidth and High Capacity Processing

CAPACITY AND POWER

The SPM is Nortel's new high-speed, multi-application switch peripheral that interfaces remote equipment and other switches to the DMS SuperNode system. By offering optical interfaces, high-capacity multi-application processing, very wide message bandwidth, and slot-independent application cards, this peripheral enables new network flexibility and significant cost of ownership savings.

With OC-3 interfaces, the SPM is an ideal integrated interface for easy entry into public data services, video, and other high bandwidth offerings that exceed the limits of traditional trunking systems.

Voice-Ready ATM

Just as T1 costs dropped once that digital interface started carrying voice traffic, the deployment of ATM is anticipated to become increasingly more cost-effective as it carries voice calls. Its integrated echo cancellation and other inherent design features make the SPM ready to accommodate voice traffic over ATM interfaces so that virtually any mix of voice and data services can be supported.

Digital Signal Processing (DSP) Applications

The SPM's digital signal processors take full advantage of leading-edge DSP technology to support such services as voice encryption, echo cancellation, and tone generation. This design enhances sound quality, integrates key service circuits closer to the DMS-Core, and simplifies service deployment.

PLANNED ENHANCEMENTS

SPM	Prerequisite for:	Available
	<i>None currently established</i>	1H99

The SPM is a next-generation, multi-application switch peripheral. Able to adapt to meet different service needs, this flexible vehicle cost-effectively delivers new high-value network applications in a multivendor environment with increased service velocity and reduced operating costs.

Value

- **Offers new revenue-generating potential**—The SPM provides an integrated solution for network providers to enter into public data networks and other high-bandwidth services. This peripheral offers significantly expanded capacity for optical-based applications and services. Its use of open, industry standards in hardware and software keeps the SPM ready to take on emerging services—such as OC-3 and STS-1 high-speed trunking—and helps network providers cost-effectively ride the technology curve into the next century.
- **Enhances switch performance**—The reliability and robustness of the DMS SuperNode are fine-tuned by the SPM's extremely generous bandwidth to ENET and its high performance processor—calculated to support as many as 24 call attempts a second. By completing a range of its own local call processing and maintenance functions—offered by the self-routing nature of the asynchronous transfer mode (ATM) protocol—the SPM can potentially free up additional computing resources at the Computing Module.
- **Reduces cost of DMS SuperNode ownership**—The new peripheral helps significantly lower operating costs by offering a footprint reduction between 4 to 6 times that of current trunk configurations—with associated on-going savings in cross-connects, power, and air conditioning requirements. Also, its flexible circuit packs permit the SPM to replace a variety of single-function peripherals, with associated reductions in housing, engineering, training, site recording, and sparring costs.
- **Streamlines maintenance and troubleshooting tasks**—The SPM's improved self-testing and other automated maintenance capabilities contribute to a calculated weighted downtime of less than thirty seconds a year—and an average dead office recovery duration of between four and five minutes. Improved diagnostics permit fault detection and isolation down to a single card. Also, its architecture permits hot insertion and extraction of its Resource Modules, to sharpen recovery times and decrease the time to complete service changes.

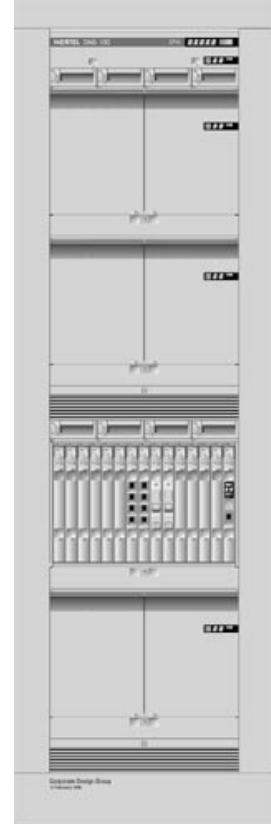

Drivers

As a multi-functional switch peripheral, the SPM can deploy a wide range of profitable voice and data services with reduced floor space, maintenance personnel, and investment requirements. Add to this the performance enhancements and cost savings and offered by direct integration of optical interfaces, and the SPM offers a compelling integrated solution.

Transition Plan

There are no currently established requirements involving the SPM. This new peripheral requires the Enhanced Network (ENET) switching fabric.

OC-3 Digital Trunking	Prerequisite for:	Available
	<i>None currently established</i>	1H99

This capability on the SPM introduces a high-capacity SONET-based trunking interface on the DMS-100/200 system. Each 155.52 megabits-per-second OC-3 trunk replaces 84 DS-1s (2016 DS-0s).

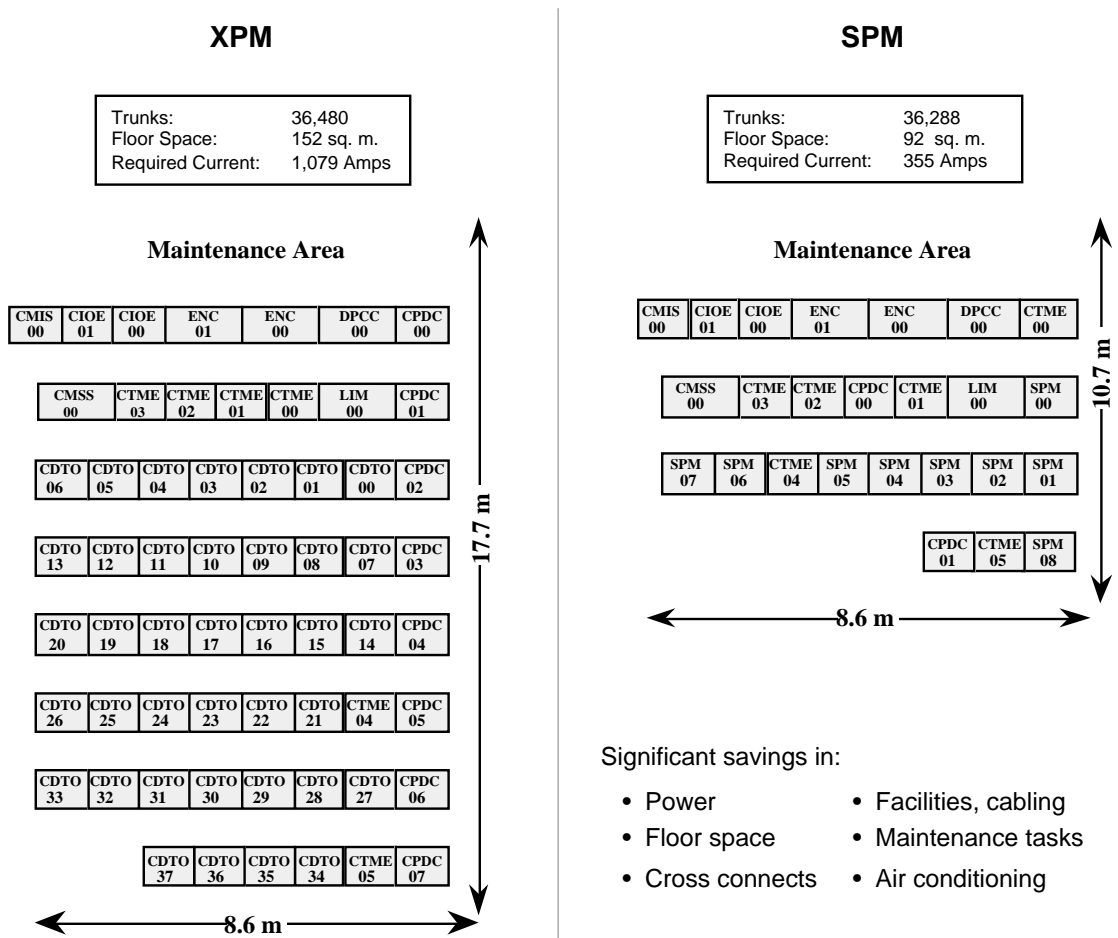

Ongoing Savings in Operating Costs with OC-3 Trunking on the SPM

Value

- **Lowers cost of DMS system ownership**—through the SPM’s small footprint, low power consumption, and high-capacity trunk interfaces. Refer to the illustration on the facing page for a depiction of the SPM’s potential to reduce facilities, maintenance, and power.
- **Gracefully migrates local DMS-100/200 nodes to broadband networks**—Offers cost-effective, transparent interconnection with a SONET/ATM backbone network.

Transition Plan

There are no currently established requirements involving this (and the following interfaces, below) on the SPM. The Enhanced Network (ENET) is required with the SPM.

STS-1 Digital Trunking	Prerequisite for:	Available
	<i>None currently established</i>	2H99

This capability on the SPM introduces a 51.84 megabits-per-second SONET-based trunking interface on the DMS-100/200 system. Each Synchronous Transport Signal Level 1 (STS-1) trunk replaces 28 DS-1s (672 DS-0s). This base-rate optical interface expands deployment flexibility for a variety of applications not requiring the capacity of OC-3 trunking.

ATM Interface	Prerequisite for:	Available
	<i>None currently established</i>	<i>TBD</i>

This future capability on the SPM directly interfaces the Asynchronous Transport Mode (ATM) standard with the DMS-100/200 system. This flexible interface multiplexes any mix of digital traffic types into fixed-length cells that can be switched at very fast speeds across a multivendor network.

Value

- **Easy upgrade path**—This interface offers a graceful path to migrate DMS-100 systems to broadband networking with minimal hardware expense.
- **Integrates to the DMS-100/200 system a proven multiplexing solution**—Early trials of ATM have yielded unparalleled transport rates, simplified connectivity, and efficient bandwidth control that accommodates almost any type of digital traffic. This flexibility and speed can help significantly lower on-going operating costs and enhance the life cycle costs of a wide range of multivendor equipment.

Drivers

Able to integrate a broad range of traffic types and applications with efficiency and speed, ATM shows significant promise to be the transport of choice for voice, data, fax, video, and multimedia. ATM is bandwidth-transparent and handles a dynamically variable mixture of services at different bandwidths and speeds. The SPM’s support of ATM brings this highly adaptive path into the private realm, closer to subscribers than was possible before.

Line Concentrating Module (LCM)

First level interface to subscriber lines from the DMS SuperNode.

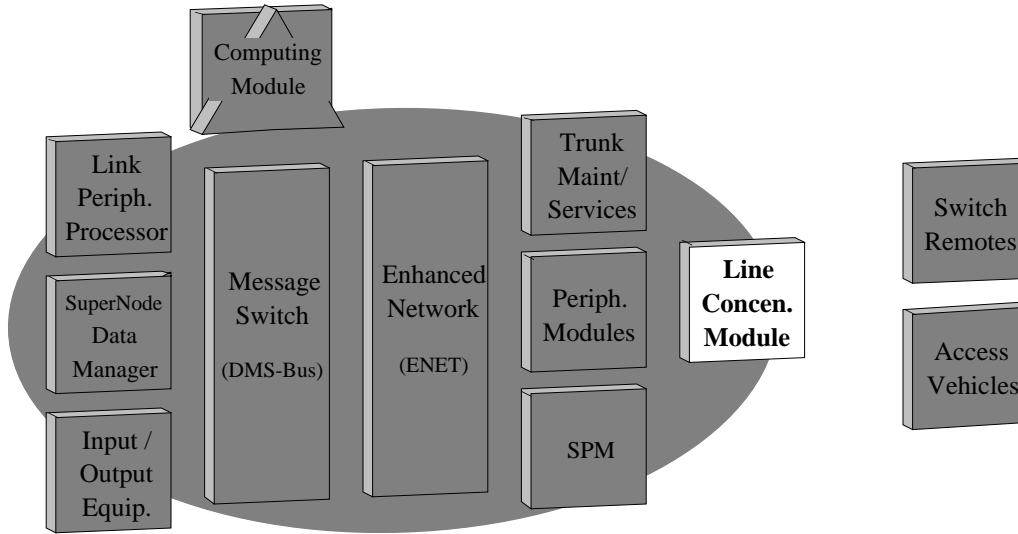

LCMs and ISDN LCMs Provide Interfaces to Subscriber Lines

Hardware	Page
LCM Processor	46
1-Meg Modem Service	46

The LCM Peripheral Module houses a variety of line cards, including the new World Line Card. This multiplexing frame also completes low-level call processing and performs analog to digital conversion. The “ISDN LCM” is the most advanced version of the LCM, supporting ISDN service alongside the traditional services of other line cards.

The substantial growth in dial-up data traffic (and the long holding times of these calls) places significant stress on the public switched telephone network. The result, in many networks, is increased equipment expenditures and additional labor costs for monitoring and load balancing. Today, the DMS-100 LCM provides a superior architecture to handle pockets of high century-call-seconds (CCS) traffic by offering much larger concentration groups within its line peripheral as compared to other switch architectures.

LCM LINK EXPANSION TO SUPPORT INTERNET

LCM line expansion offers a simple, cost-effective way to address substantial demands for dial-up data service. Expanding the number of links between the Line Group Controller (LGC) and the LCM increases the pool of channels to help relieve network congestion and blockage. This option—along with the LCM’s digital-based, single-stage concentration—eliminates the need for a number of complex line assignments to maintain traffic distribution. As a secondary measure, the number of lines per LCM can be reduced to accommodate higher holding times, using simple operations support system (OSS) line assignments.

The LCM offers an inexpensive method of changing concentration ratios that does not impact existing line assignment designations. CCS capacities between concentration ratios, this digital-based line unit can be engineered to a termination limit at a higher CCS.

SINCE THE PREVIOUS EDITION . . .

The following three products—discussed in the previous issue of the *DMS-100/200 Hardware Planning Guide*—are now available as integral parts of the DMS-100/200 portfolio.

World Line Card (WLC)	Prerequisite for:
NT6X17BA and NT6X18BA	<i>None currently established</i>

The WLC brings greater flexibility to voice line card technology, such as having software control of key parameters to suit various transmission requirements. The WLC ships with all initial systems and with expansions in existing offices, currently available in two main versions:

- ◆ Type A NT6X17BA: for POTS, CLASS, MDC 2500 sets, Teen Service, and Local Message Service.
- ◆ Type B NT6X18BA: for all the above plus Coin, Ground Start, and PBX lines.

Either card requires the Extended LCM Processor (NT6X51AB or NT6X51AC).

LCM Talk Battery Alarm	Prerequisite for:
	<i>None currently established</i>

To enhance LCM robustness, this feature reports (through DMS SuperNode alarms and logs) the loss of talk battery current to any LCM shelf. This optional upgrade is available on North American LCM variants with 256K processors (NT6X51AB or NT6X51AC) that support the World Line Card (not available on LCMs with NT6X51AA 64K processor). This option requires a minimum of one World Line Card (NT6X17BA or NT6X18BA) per Line Concentrating Array. Since the LCM Talk Battery enhancement is non-intrusive, the WLCs used may also provide normal subscriber service. Alternatively, one of the two WLCs may be in the maintenance line slot (Line 0 of Drawer 0 of LCM 0 of the Line Concentrating Equipment frame).

Extended LCM Processor	Prerequisite for:
NT6X51AC	<i>None currently established</i>

This processor features a light-emitting diode (LED) indicator to enhance a variety of maintenance tasks. Like the earlier NT6X51AB, the processor’s extended memory and advanced diagnostics support revenue-generating features (such as Calling Number Display) that broadens revenue opportunities for the network provider.

	<i>present</i>	<i>3Q97</i>	<i>4Q97</i>	<i>1Q98</i>	<i>2Q98</i>	<i>3Q98</i>	<i>4Q98</i>	<i>beyond</i>
LCM Processor		LTD	GA NA007					➤
1-Meg Modem Service				LTD Ph. I	LTD Ph. II		GA Ph. II	➤

Ph. = Phase; part of a phased introduction. See text in this chapter for details.

Planned Line Concentrating Module Enhancements

PLANNED ENHANCEMENTS

LCM Processor	Prerequisite for:	Available
NT6X51DA	NA007 ISDN Line Drawer for Remotes	LTD: 3Q97 GA: 4Q97 NA007

This processor for the Line Concentrating Module serves an interface between the Line Group Controller (LGC) and the line drawers, and scans bus interface cards, controls ringing, processes system messaging, and conducts background diagnostic tasks. This new “DA” vintage of the LCM Processor is needed with the new ISDN Line Drawer for Remotes (ILDR) hardware. NT6X51DA supplies the unique firmware that is needed to support 64 kilobits per second clear channel ISDN operation on the RLCM and OPAC/OPM switch remotes. Refer to page 54 for discussion of the many benefits of the new ISDN Line Drawer for Remotes.

1-Meg Modem Service	Prerequisite for:	Available
NTEX54AA - Data-enhanced Bus Interface Card NTEX17AA - xDSL Line Card Phase I NTEX17BA - xDSL Line Card Phase II NTEX35AA - 1-Meg Modem CPE	<i>None currently established</i>	PHASE I: LTD: 1Q98 PHASE II: LTD: 2Q98 GA: 2H98

This high-speed modem replacement transforms existing copper plant into integrated broadband loops—with no new peripherals or adjunct equipment. With a range that can reach 20,000 feet from the switching office to the customer premises, the Nortel 1-Meg Modem Service delivers 1 megabit-per-second downstream, 120 kilobits-per-second upstream, and regular 28.8 kilobits-per-second POTS capabilities—all on a single loop. A multiplexed analog channel can be used simultaneously for voice, fax, or modem calls without affecting the data speed.

To simplify cabling and administration, this option separates voice and data at the LCM, not in the outside plant or customer premises. Data travels over an Ethernet interface to a Nortel Passport switch or router to direct traffic to a frame relay or asynchronous transfer mode (ATM) network, while voice traffic continues to a standard Line Group Controller (LGC).

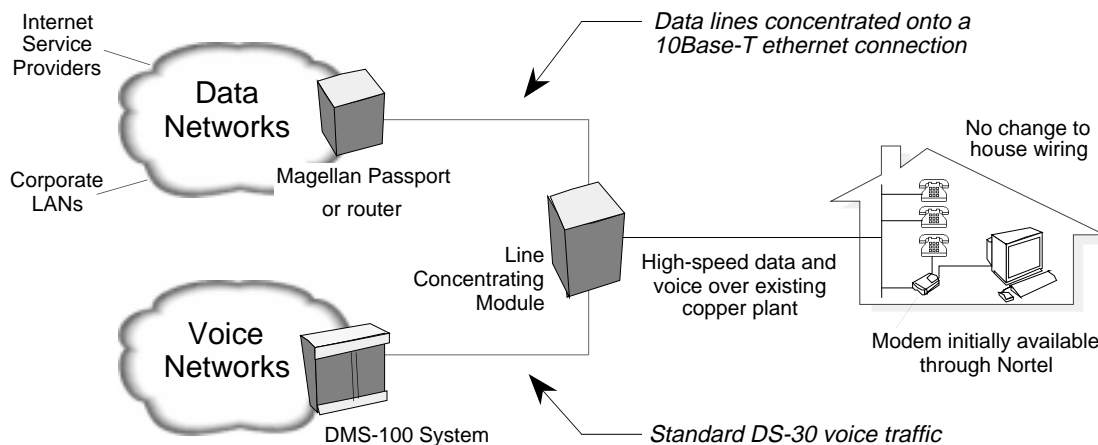

This Data Service Transforms Existing Copper Plant into Broadband Loops

Value

- **Opens new revenue opportunities**—Public carriers can now offer a fast, reliable Internet subscriber service that competes favorably against cable modems and other data access technologies—as well as offer value-added network connection service to Internet Service Providers (ISPs).
- **Leverages existing investments**—Nortel 1-Meg Modem technology supercharges Internet and work-at-home data access while minimizing the operational, logistical, and engineering impacts to both the switching office and the subscriber’s home by using the current DMS system line-peripheral infrastructure—including RLCM, RSC-S, and RSC on the DMS-100 and DMS-10 systems—and the subscriber’s existing copper loop.
- **Offers minimal risk**—The low start-up costs enable service providers to enter the lucrative data services market with minimal risk. A new Data-enhanced Bus Interface Card (DBIC; NTEX54AA) per LCM line drawer and new xDSL Line Card (NTEX17) for each pertinent line are all that are replaced. *The main distribution frame is left undisturbed.* Importantly, no new frame or adjuncts are needed (unlike standard asymmetric digital subscriber line [ADSL] requirements).

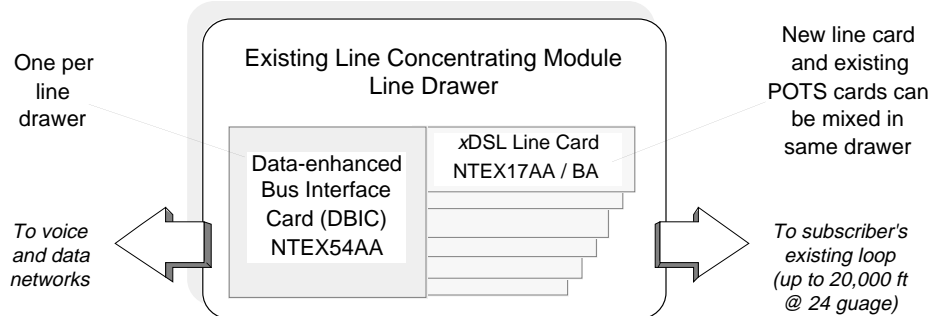
**Easy Upgrade to Existing LCMs**

Drivers

While there are many solutions targeted for work-at-home, telecommuter, and residential Internet access markets, many require new outside plant and peripherals. The Nortel 1-Meg Modem Service re-uses the network provider’s installed base of twisted pair plant to provide flexible, fast data access and voice integration with “always on” access. This quick-to-market solution delivers an attractive high-speed data service that can get subscribers ready for a smooth upsell to full, multimegabit Digital Subscriber Line (xDSL) services in the future.

Transition Plan

The Nortel 1-Meg Modem Service is planned to be released in two phases:

- ◆ Phase I, with a limited release scheduled in 1Q98, uses a dual-slot xDSL Line Card, vintage NTEX17AA, for use with DMS-100/200 switching offices and SL-100 PBX systems.
- ◆ Phase II, with a general availability scheduled in 2H98, uses a single-slot line card, vintage NTEX17BA, for DMS-100/200 remote access products and DMS-10 systems. Also in this time period, the Nortel 1-Meg Modem Service is scheduled to be integrated into Nortel’s Internet Thruway system (so it can be used with any telephone switch) and into Nortel’s AccessNode Express.

Initially, Nortel will offer the 1-Meg Modem (NTEX35AA) customer premises equipment (CPE). Eventually, the specification will be published for general production by other vendors.

Switch Remotes

Intelligent remote switching, offering full feature transparency with Intraswitching and Emergency Standalone operation.

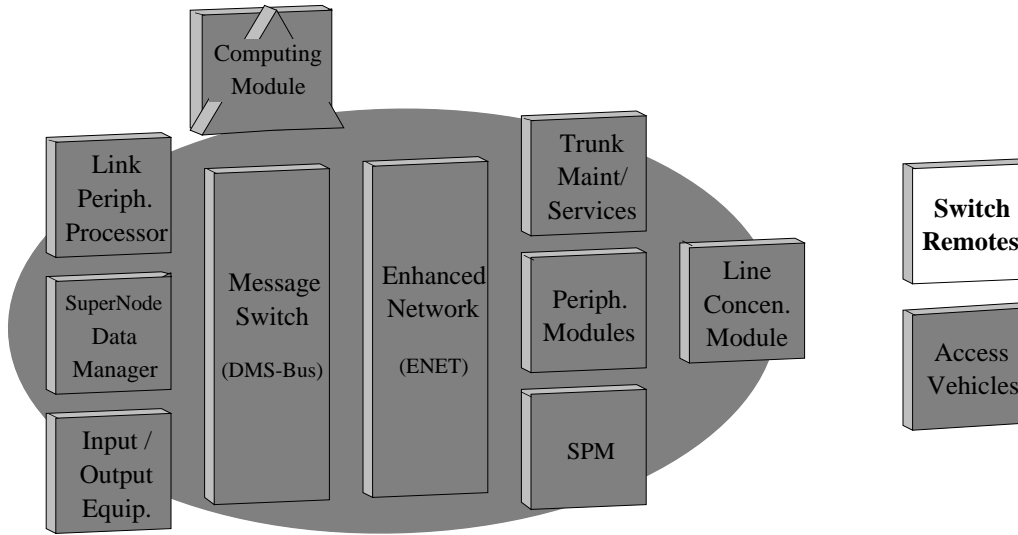

Switch Remotes Extend Digital Services to New Areas and Markets

Hardware	Page
Outside Plant Access Cabinet (OPAC) OC-1 SONET Module	53
ISDN Line Drawer for Remotes (ILDR)	54
16-Megabyte Processor for RSC-S	55

COST-EFFECTIVELY EXTENDS THE REACH OF THE DMS SYSTEM

While new businesses, shopping centers, and residential developments fuel the demand for new revenue-generating services, the pressure of rapid growth requires flexible solutions to extend these high-demand services to remotely located areas—and into new markets—simply and quickly.

DMS SuperNode switch remotes offer cost-effective solutions for this ever-changing environment, delivering the full range of host DMS SuperNode services to remotely located subscribers. These solutions offer pair gain and feeder relief by minimizing the number of links back to the central office through concentration and intraswitching at the remote terminals. And, by extending the reach of DMS SuperNode technology, these remote switching solutions provide a powerful platform for digital integration, network simplification, exchange area consolidation, and penetration into new markets or territories.

KEY CAPABILITIES

DMS SuperNode remote access vehicles provide a powerful platform for digital integration and network simplification. The following key features contribute to the robustness and survivability of switch remotes and lower the per-line cost of delivering advanced digital services.

- ◆ **Emergency Standalone (ESA)**—With ESA, local call service continues even if the connections between the host and a switch remote are severed. As a survivability feature, ESA provides the intelligence to continue call processing if the remote loses communication with the DMS SuperNode host. This feature supports POTS-type calls between remote subscribers and subtending remote digital terminals. Emergency and operator calls can route over dedicated lines or over DS-1 trunks to a subtending community dial office.

- ◆ **Intraswitching**—In applications where many switch remote subscribers place calls that terminate on the same remote, the Intraswitching feature saves a significant amount of switch resources. This feature enables calls that originate and terminate within the switch remote to be switched without using DS-1 links to the host, except during initial call setup. The Intraswitching feature offers the added benefits of minimizing outside plant expenses and reducing the number of required DS-1 links.

Also, see the next page for a detailed discussion of the many benefits of placing switch remotes in bi-directional fiber rings.

	<i>present</i>	3Q97	4Q97	1Q98	2Q98	3Q98	4Q98	<i>beyond</i>
OPAC: OC-1 SONET Module								→
ISDN Line Drawer for Remotes (ILDR)		LTD	GA NA007					→
16-Megabyte Processor for RSC-S				LTD		GA NA009		→

Planned Switch Remote Enhancements

RINGS ENHANCE SURVIVABILITY

Placing Remote Switching Centers into a bi-directional fiber ring offers significant benefits to the network provider.

- ◆ **Enhances revenue opportunities**—The network provider can include service-survivability offerings in a portfolio. Self-healing bi-directional rings minimize the possibility of service interruption: a degradation or break causes traffic in the ring to travel in the opposite direction, usually without end users noticing an interruption. This can be a differentiator for a network provider, especially one serving business subscribers.
- ◆ **Offers easy changes with complete service independence**—The network provider can incorporate new communities or relocate existing subscribers quickly and cost-effectively. Adding or removing a remote from the ring usually does not affect basic ring design or operation.
- ◆ **Reduces hardware requirements**—Rings reduce the total amount of outside plant cabling required from the central office to all switch remotes. Reductions in remote maintenance and synchronization hardware also help the network provider's bottom line.
- ◆ **Optimizes network operations**—Ring topologies streamline labor-intensive service provisioning and maintenance tasks—and speed the velocity of new service introduction.

EDC REDUCES HARDWARE

A network provider that deploys the optional Extended Distance Capability feature to switch remotes placed on fiber rings can immediately profit from a number of benefits.

- ◆ RSC-Ss with EDC can be components of larger rings, minimizing the capital and operating expenses of multiple ring deployment.
- ◆ With EDC, one remote can potentially replace a number of small remotes for a given geographic area. This efficiency can reduce capital and operating expenditures, ranging from the number of remotes to the total amount of connections to voice and CCS7 networks. Limiting the number of remotes can also reduce the time and effort required to deploy new services on a network-wide basis.
- ◆ Since EDC extends the remote-off-remote distances, network providers can decrease the time required to introduce telephone service to new communities under development, with greater flexibility in the choice of remotes. The increased remote-off-remote distance also facilitates Emergency Standalone operation for a larger area than before, increasing the number of calls that can still be completed if the links to the host (directly or through a ring) are severed.

RSC TO RSC-S CONVERSION WITH THE RSCE

The Remote Switching Center-S (RSC-S) has provided capacity and performance benefits to network providers since BCS35. Now, with the Extended Distance Capability offering the longest “reach” from a host to a switch remote in the industry, the advantages of the RSC-S have become even more attractive.

To help network providers profit from RSC-S deployment, Nortel now offers a cost-effective method for converting the current Remote Switching Center (RSC) to the RSC-S. A single frame (the “RSCE”) offers the capacity increases of the RSC-S while maximizing the reuse of existing equipment.

This offers a number of benefits to the network provider:

- ◆ **Offers new cost-saving features**— Conversion to RSC-S provides significant network provisioning and operating benefits with features, such as the Extended Distance Capability, not possible with previous technology. The conversion also permits a greater density of National ISDN at the remote location and supports an increase in line capacity.
- ◆ **Optimizes hardware investments**— An upgrade to the RSC-S offers new incremental growth potential that builds on the network provider’s capital investment and offers an economical response to current and future service demands by enabling network providers to reuse existing equipment whenever possible.

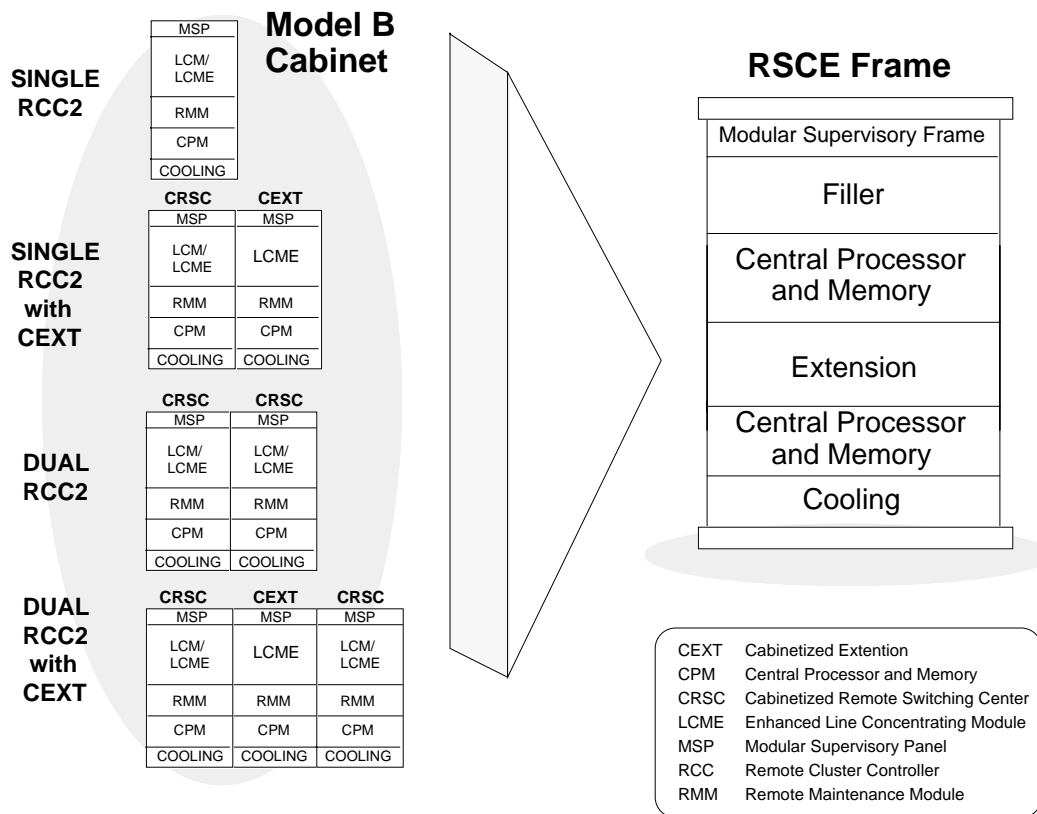

The RSCE Frame Incorporates Existing Equipment Where Possible

SINCE THE PREVIOUS EDITION . . .

The following—discussed in the previous issue of the *DMS-100/200 Hardware Planning Guide*—is now available as an integral part of the DMS-100/200 portfolio.

Extended Distance Capability (EDC)	Prerequisite for:
NTMX76AA and NT6X50AB	<i>None currently established</i>

Network providers can now extend high-demand revenue-generating services—such as Meridian Digital Centrex (MDC), ISDN, Custom Local Area Signaling Services (CLASS), and Datapath—outside the customary reach of the host office. EDC requires two Extended Distance Messaging circuit packs (NTMX76AA) in both the host and remote, DS-1 Interface circuit packs (NT6X50AB) in the host, and XPM PLUS in the peripherals.

An upgrade to the Extended Distance Messaging circuit packs, NTMX76AB, is scheduled to be available 3Q97. The AB vintage is required only if the RSC-S will also support Spontaneous Call Waiting Display (SCWID) based on an Analog Display Services Interface (ADSI) service. In all other configurations, the new NTMX76AB version is considered optional.

The development of the following products, discussed in the previous issue of the *DMS-100/200 Hardware Planning Guide*, has been deferred.

Additional Messaging Links	NTMX87AB
-----------------------------------	----------

BITS Clock Interface for RSC-S	NTMX73AB
---------------------------------------	----------

Remote Access Status Product (RASP)	No Number
--	-----------

PLANNED ENHANCEMENTS

OPAC: OC-1 SONET Module	Prerequisite for:	Available
NT2A series	None currently established	Now

Nortel offers an integrated optical carrier interface for access feeder applications. Housed in the full-service Outside Plant Access Cabinet (OPAC), this 51.84 megabits per second fiber transmission multiplexer (MUX) provides cost-effective DS-1 and Ethernet-LAN speed data services to complement SONET network solutions.

Ultra compact and self contained, these modules support 4 DS-1s and two-native-LAN speed data/Internet ports, or up to 28 DS-1s—with a choice of optical ranges and protection options.

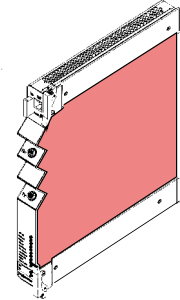

Value

- **Offers easy installation and maintenance**—The plug-in OC-1 SONET Access Module is an easily provisioned module that supports in-service software upgrades. Its performance monitoring and alarm/virtual tributary (VT) management features significantly reduce the need to dispatch service personnel for on-site visits. Optional PC-based applications software provide superior maintenance features, such as graphical dialogs and icons for performance and bandwidth management, in-service software upgrade capabilities, and other menu-driven options.
- **Expands OPAC connectivity**—The OC-1 Module is appropriate for point-to-point applications employing 4, 8, or 14 DS-1s—or can support two Ethernet native data ports and 4 DS-1 services. An optional Synchronous Transport Signal Level 1 (STS-1) port can provide up to 28 optically protected DS-1 signals in point-to-point applications—or the module can be used as a stand alone multiplexer/demultiplexer in a local environment.
- **Provides reliable service**—The OC-1 Module uses field-proven, highly integrated, and hardened electronics that meet stringent environmental standards for carefree operation in outside plant cabinets.

Drivers

Modules can be supplied to meet immediate DS-1 needs or—with extra STS-1 and Ethernet interfaces—to accommodate economical connectivity solutions. For example, both Ethernet-native LAN-speed services and DS-1 services can be delivered to a customer premises over a single network. When equipped with an STS-1 interface, the modules offer inexpensive and simple connectivity to SONET transport networks.

Transition Plan

Module kits are engineered and pre-packaged for easy installation in OPACs and can also be used on AccessNode Full Service Terminals (FSTs) and DMS-1 URBAN remotes (S100E, S600E, and S800E). Kits are also available for the earlier Outside Plant Modules (OPMs) and customer premises configurations.

For More Information

- *OC-1 SONET Access Module; Product/Service Information* bulletin (56029.16)
- *Outside Plant Access Cabinet Expands DMS Remote Capabilities; Product/Service Information* bulletin (50089.16)

ISDN Line Drawer for Remotes (ILDR)	Prerequisite for:	Available
NT6X05DA	<i>None currently established</i>	LTD: 3Q97 GA: 4Q97 NA007

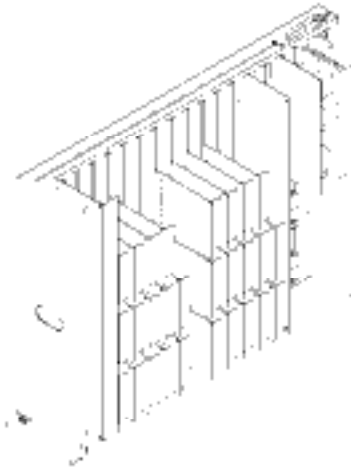

This compact line drawer serves as a cost-effective solution to delivering ISDN Basic Rate Interface (BRI) to those subscribers served by remotes. With multiple drawers this integrated solution supports up to a maximum of:

- ◆ 196 ISDN lines in Remote Switching Centers (RSC-S or RSC); a total of 392 ISDN lines in a dual RSC-S or RSC.
- ◆ 56 ISDN lines in an Outside Plant Access Cabinet (OPAC), Outside Plant Module (OPM), or Remote Line Concentrating Module (RLCM).

This drawer, capable of up to 144 kilobits per second voice or data high-speed transfer, is especially advantageous to small line size applications off LCM-based remotes.

Value

- **Extends life cycle of existing equipment**—The ILDR enhances the value of the network provider’s existing investments by eliminating the need to overlay the existing remote with either a channel bank or a second remote.
- **Reduces operating costs**—This line drawer eliminates the requirement to purchase and maintain channel banks. By sharing common spares with the host, overall sparing requirements are reduced. Additionally, the Enhanced Data Channel Handler (EDCH) functionality is integrated with the drawer, eliminating the need for external D-Channel Handler hardware.
- **Integrated with DMS SuperNode**—The ILDR’s operations, administration, maintenance, and provisioning (OAM&P) procedures integrate with the remote to streamline maintenance procedures and maintain consistency on remotes hosted off the DMS-100 and DMS-10 systems.

Drivers

The current surge in service demands for reliable Internet access is unprecedented. ISDN line growth is not limited to high population areas—subscribers in rural and low population areas are also demanding high-speed access to the Internet, online servers, and corporate databases. The ISDN Line Drawer for Remotes offers new economies for deploying ISDN to these business and residential accounts.

Transition Plan

Scheduled for general availability in 4Q97, the new ISDN Line Drawer for Remotes uses standard U-type ISDN line cards for use in the RSC-S (and RSC), OPAC (and OPM), and RLCM remotes. Initially, this drawer supports National ISDN-1 BRI features without emergency standalone capabilities.

The hardware requirements are: NT6X51DA LCM Processor and NT6X50AB DS-1 Interface card (NTMX81AA with RSC-S) at both the host and remote.

For More Information

- *Nortel Introduces Low-Cost ISDN for DMS-10, DMS-100; Product/Service Update* article (50049.17/12-96 Issue 10)
- *Feature Planning Guide 1997-1998*; page 49 (500004.11 Issue 17)

16-Megabyte Processor for RSC-S	Prerequisite for:	Available
NTAX74AA	NA009 RSC-S <i>Other prerequisites for Peripheral Modules in NA006 appear on pages 34 and 35</i>	LTD: 1Q98 GA: 3Q98 NA009

This high-performance processor—calculated to affect a small percentage of the installed XPM peripherals and switch remotes in the field—supplies the memory and processing power to support:

- ◆ Emerging revenue-generating services through the Remote Switching Center-S (RSC-S), including the expanding capabilities offered by National ISDN-2/3. New industry standards expand interface protocols and services and add functionality through uniform text display, data interworking, and other sophisticated capabilities across a multivendor network.
- ◆ The Emergency Standalone (ESA) option, which continues call processing for local POTS call service when lines are severed between a host and the RSC-S. ESA provides the intelligence to continue local routing, such as between an RSC-S and subtending remote digital terminals. To meet the increased demands of ESA operation in an environment offering advanced services (in normal mode), a larger 16-megabyte processor will be needed in the RSC-S.

Value

- **Expands revenue potential and maintains a superior service level**—When the Computing Module software load has revenue-generating advanced services, this high-performance processor enables the RSC-S to support the latest revenue generating potential of National ISDN—enabling high-value services such as Calling Name Identification Service. Its enhanced processing capacity supports more robustness, performance, and diagnostic features and offers a high class of service through optional Emergency Standalone operation.
- **Minimizes operating costs**—On-board Error Detection and Correction (EDAC) circuitry lowers the possibility of a service-affecting incident. Its expanded capacity can eliminate or defer the need for costly load redistribution of real time- and memory-intensive lines, such as ISDN.

Drivers

Growing demand for Internet access, telecommuting, business voice and data interworking, and other applications that can be offered through National ISDN services has network providers seeking ways to reliably offer ISDN services at business centers, industrial parks, shopping malls, and other developments at ever increasing distances from the central office. This processor in the RSC-S switch remote supports extending the revenue-generating potential of National ISDN, while building on the service protection of the Emergency Standalone option.

Transition Plan

To support the larger memory requirements of revenue-generating services, such as National ISDN-2/3 features, the RSC-S peripheral platform needs the capacity and operating efficiencies of the NTAX74AA processor in the NA009 time frame.

Access Vehicles

Extend the advantages of digital switching deeper into the network.

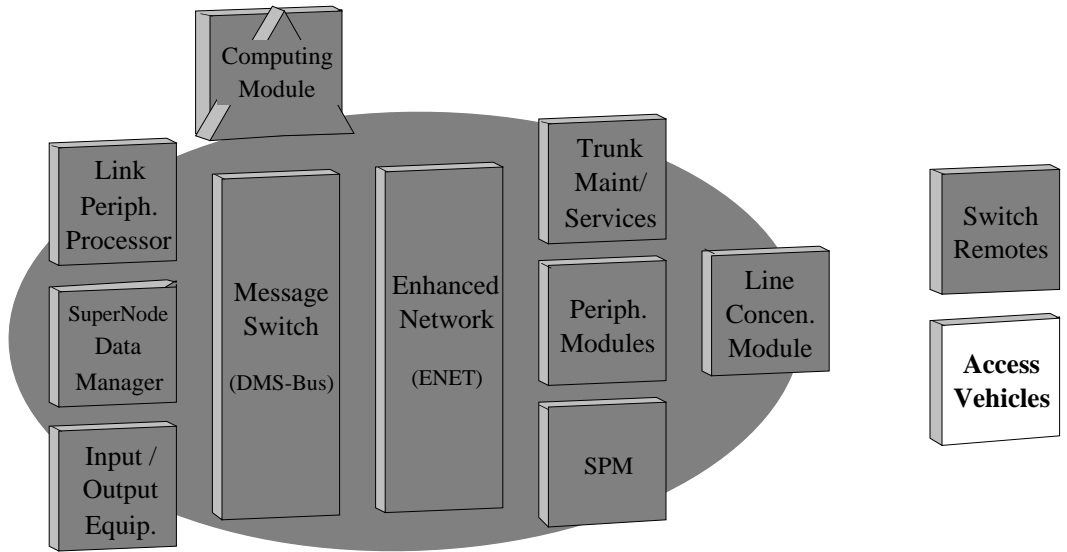

Cost-Effective and Intelligent Remote Terminals

Hardware	Page
Internet Thruway	58
Rapport	60
AccessNode Express	60

RELIABLE MULTIVENDOR SUPPORT

Today’s network has grown increasingly complex and diverse. Industry standards simplify the engineering and expansion of these networks, and enable service providers to make the best use of existing equipment in a multivendor environment.

Nortel’s digital access vehicles align with Bellcore standards so the network provider can respond quickly to rapidly changing market demands while protecting investments in existing equipment.

By offering various direct digital interfaces for remote digital terminals that comply with Bellcore TR-08 and TR-303, this hardware group gracefully supports POTS, CLASS, Meridian Digital Centrex (including Meridian Business Set features), and National ISDN— as well as profitable new residential broadband and multimedia applications.

	<i>present</i>	<i>3Q97</i>	<i>4Q97</i>	<i>1Q98</i>	<i>2Q98</i>	<i>3Q98</i>	<i>4Q98</i>	<i>beyond</i>	
Internet Thruway		GA Rel. 2							➤
Rapport Dial-up Switch									➤
AccessNode Express	LTD	GA							➤

Enhancements Discussed in this Chapter

SINCE THE PREVIOUS EDITION . . .

The following two products—discussed in the previous issue of the *DMS-100/200 Hardware Planning Guide*—are now available as integral parts of the DMS-100/200 portfolio.

Cornerstone	Prerequisite for:
	<i>None currently established</i>

Delivery of data, voice, and interactive multimedia over a hybrid fiber/coax infrastructure can now be made cost-effectively through Cornerstone solutions. As part of Nortel’s total network solutions, Cornerstone products and services offer central office, head end, and subscriber premises network elements with high bandwidth, superior reliability, and low equipment, installation, and maintenance costs.

AccessNode	Prerequisite for:
	<i>None currently established</i>

The multi-functional AccessNode simplifies the network through offering service adaptive cards, fiber and copper interfaces, survivable network topologies, multi-hosting off other vendor switches, and sophisticated surveillance and testing facilities. It is the ideal platform for both narrowband and emerging high bandwidth technologies.

PLANNED ENHANCEMENTS

Internet Thruway	Prerequisite for:	Available
	<i>None currently established</i>	Rel 1: Now Rel 2: 3Q97

Although Nortel's DMS SuperNodes accommodates the surge of Internet/LAN access data traffic, other switching office systems may be pre-engineered at the factory for fixed-volume voice traffic and could require a costly and labor-intensive re-grade for higher traffic levels. Internet Thruway can help avoid these expenditures, conserve voice network resources, and enable the public carrier to generate new revenue through enhanced service to subscribers, Internet Service Providers (ISPs), and corporate accounts. With Internet Thruway, network providers can efficiently manage the explosion of data traffic by moving dialup Internet/remote LAN access traffic off the public network before it reaches the voice switch.

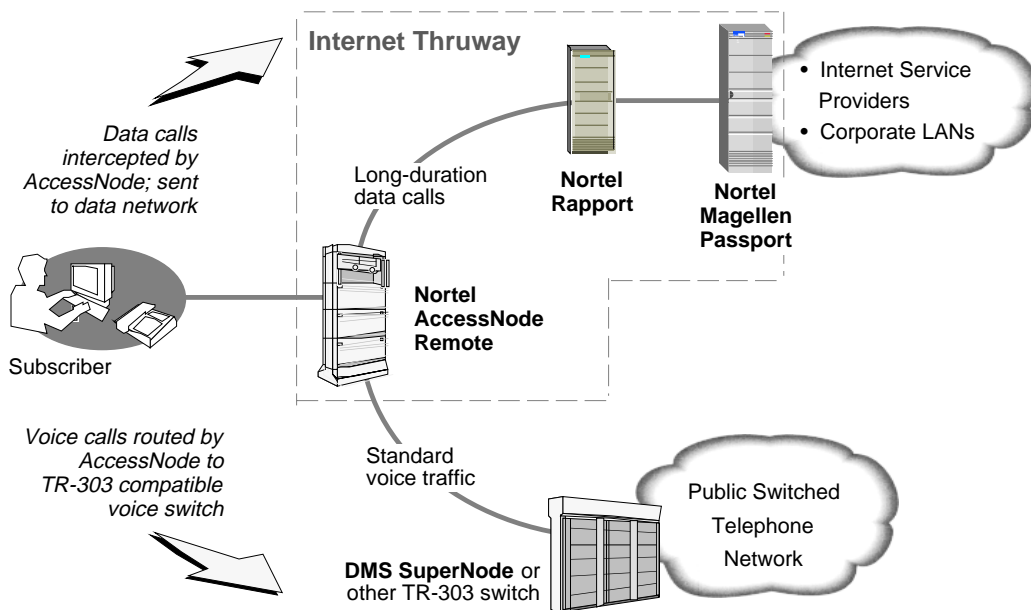

Gracefully Diverts Data Traffic Before Calls Reach the Voice Switch

This integrated solution brings together several key products and services from across Nortel:

- ◆ **AccessNode Data Direct** (on the AccessNode or AccessNode Express) routes data calls—including true 56 kilobits per second (kbps) modem connections—off the public switched network, based on dialed number.
- ◆ **Rapport Dialup Switch** provides modem termination service and routes dialed data calls to the appropriate service providers or enterprises using Layer Two Forwarding (L2F)—and adds Nortel's Secure Public Dial capabilities so ISPs can have full login and authentication control.
- ◆ **Magellan Passport** frame/cell-data switch supports high-capacity wide-area-networking services with frame relay. Release 2 supports asynchronous transfer mode (ATM) transports, including Internet Protocol (IP) over ATM.
- ◆ **Internet Thruway Network Controller** enables the network provider to offer home-gateway balancing to ISPs from within the Internet Thruway system. Also, its network-level, port-

limiting services dramatically simplify engineering and operations tasks for ISP connection management.

- ◆ **Network Service Solutions (NSS)** group provides a comprehensive set of network management services to deliver turnkey, end-to-end services, such as a single display showing the status of all nodes in the system, including the home gateway router.

Value

- **Offers new revenue opportunities by satisfying subscribers**—Internet subscribers and telecommuters can enjoy a higher grade of service because they do not have to compete with voice callers for access during peak traffic hours. And, since the AccessNode's Data Direct Capability does not use robbed-bit signaling, the modem connect rates are at a modem's actual rated speed (such as true 28.8 kbps instead of the network's usual 26.4 kbps).
- **Conserves voice network resources**—By directing data calls around the voice network, Internet Thruway can delay or eliminate the need for costly switching office upgrades.
- **Opens expanded revenue opportunities by satisfying ISPs and corporate accounts**—ISPs and corporate sites can reduce their equipment on-site because the network provider can provide standards-based 56 kbps modem termination, traffic concentration, routing services, and high-speed frame relay or ATM access on a fee basis. Users have the security of private dialup lines while enjoying the cost advantages of shared public carrier resources.
- **Integrates operations, administration, maintenance, and provisioning (OAM&P)**—High-value OAM&P services reduce the cost and complexity of maintaining this system. For example, the Integrated Traffic Management System (ITMS) provides a single Maintenance and Administration Position (MAP) display of the Internet Thruway nodes, including the home gateway router. Another service, Network Controller, enables the network provider to bundle and manage ports on a software, rather than hardware, basis.
- **Deploys easily across the multivendor network**—This end-to-end solution operates with any TR-303 compliant switching office—so it can be deployed across an entire network for uniform operation across all serving areas.

Drivers

This turnkey solution gracefully addresses the switching capacity issues associated with the explosion of Internet and intranet access traffic. At the same time, the special features of this system, such as modem termination at true modem-rated speeds, help retain and attract valued ISP and corporate accounts.

Transition Plan

There are no currently established requirements involving the Internet Thruway. As a long-term solution, the Internet Thruway's architecture has the flexibility to accommodate most emerging access technologies as they become available, such as Asymmetric Digital Subscriber Line (ADSL) solutions.

For More Information

- *Introducing Nortel's Internet Thruway Program; Product/Service Information* bulletin (74026.16)
- *Internet Thruway Offers Solution for Long-Duration Calls; Product/Service Update* article (50049.17/12-96 Issue 10). See also a deployment article in the 50049.17/02-97 edition.

Rapport Dialup Switch	Prerequisite for:	Available
	<i>None currently established</i>	<i>Now</i>

The Rapport Dialup Switch offers high-performance access to the Internet and remote corporate locations over the public telephone network. Telecommuters, consumers, students, and laptop users benefit from convenient, high-quality dialup connections; the network provider benefits from a single management system with advanced features that simplify changes.

Value

- **Offers scalable portfolio**—The Rapport family supports both analog and ISDN dialup calls with a scalable platform that enable smooth growth from 8 through 672 simultaneous dialup users.
- **Addresses multiple markets**—The network provider can address multiple applications with Internet access, remote access to enterprise intranet, dial-out access to branch office LANs, and outbound fax using the WAN to eliminate costly long distance charges. This flexibility helps the provider to upsell subscribers to higher speed digital switch services such as ISDN BRI.
- **Supports flexible deployment options**—The network provider has the option of large scale deployment either in a single, high-density point of presence—or distributed around a frame relay or ATM wide area network configuration. WAN interfaces can range from T1/E1, through T3/E3, to OC-3, with a list of security options. And enterprise users benefit from a flexible platform that incorporates Ethernet, token ring, and frame relay connectivity.

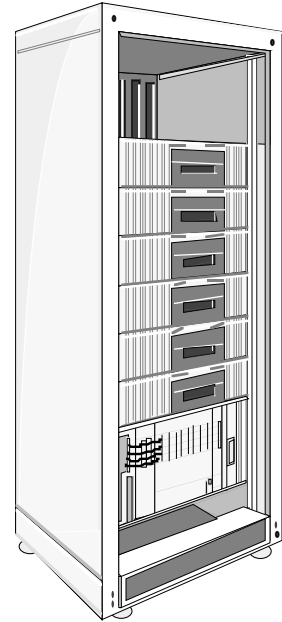

Drivers

One estimate places the number of Internet subscribers worldwide at some 100 million users by 1998. Mobile workers, home-based companies, and telecommuters also accelerate the explosive growth for data. The Rapport family of products can help service providers and enterprise networks expand access to be in step with the evolution and growth of data services without the management requirements of terminal server/router solutions.

AccessNode Express	Prerequisite for:	Available
	<i>None currently established</i>	LTD: 1Q97 GA: 3Q97

Of immediate concern to many service providers is the effect on the telephone network of lengthy Internet and corporate LAN access calls. To reduce the impact of these calls, Nortel offers AccessNode Express. This scalable access remote, for voice and data, supports the Data Direct feature that elegantly grooms data calls to a dial-up data switch instead of to the voice switch. And, with AccessNode Express, Internet surfers can operate their 28.8 kbps modems at top speed—a capability not supported by next generation digital loop carriers from many vendors. For subscribers desiring direct digital data access, AccessNode Express supports cost-effective Ethernet connectivity as well as economical delivery of ISDN BRI service.

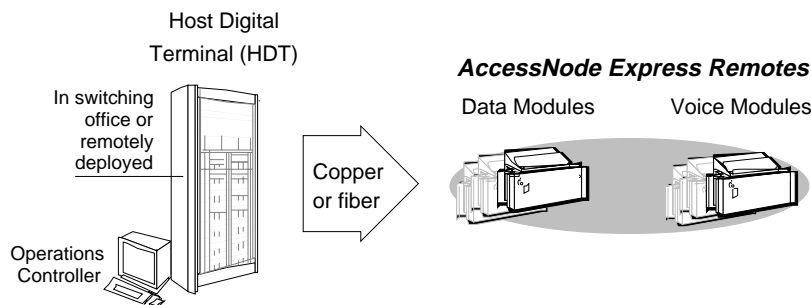

Flexible, Scalable AccessNode Express Components

Value

- **Host Digital Terminal reduces operating costs**—The AccessNode Express Host Digital Terminal (HDT; in a switching office or at a remote site hundreds of miles distant) ensures optimum port usage by grooming incoming DS-1s from remote modules into a single optimized TR-08 or TR-303 interface. The switch sees each HDT as a single remote, regardless of the number of subtending remote modules. This efficiency can reduce switch costs by hundreds of dollars per line.
The HDT also provides enhanced operations, administration, maintenance, and provisioning (OAM&P) by offering an Operations Controller (OPC). The OPC services as a central point of control for multiple network elements that can handle up to 224 AccessNode Express modules.
- **Remote modules offer simplified scalability**—The modular remote modules offer optimum configuration flexibility. Up to six 48-line Voice Modules, Data Modules, or both, can be deployed at a single remote location (for a total of up to 288 lines). Adjustments to accommodate future expansion can be made simply and easily.
- **Remote modules help reduce operating costs**—The Voice Module accepts the remotely programmable Service Adaptive Access line card that can significantly save provisioning costs. Since subscriber requests for new services, such as ISDN, can be met by downloading software—no line card or other hardware changes are required.

Drivers

The changing telecommunications landscape has presented the challenge of finding efficient ways to accommodate long-holding time Internet and intranet calls. The widening popularity of data access has service providers searching for cost-effective ways to relieve the voice network from costly network congestion. AccessNode Express offers a cost-effective solution with a flexible platform that can fit any remote access plan.

Transition Plan

The versatile AccessNode Express can be cost-effectively deployed in areas with demand for sophisticated, high-bandwidth services—such as forward-looking TR-303—as well as at POTS-oriented sites traditionally served by TR-08 remote vehicles or channel banks. Up to 14 remote modules with a total capacity of 672 lines can feed a single HDT over copper or fiber transport links. In multihosting scenarios the HDT can serve up to five local digital switches.

The AccessNode Express offers numerous options to feed the remote sites—DS-1, HDSL, ASYNC, or SONET. For delivery of high-bandwidth services, the S/DMS TransportNode OC-3 Express is an ideal transport vehicle to complement the Voice and Data Modules of the AccessNode Express.

Link Peripheral Processor (LPP)

A single platform that cost-effectively supports a range of CCS7 and advanced data applications for the Information Age.

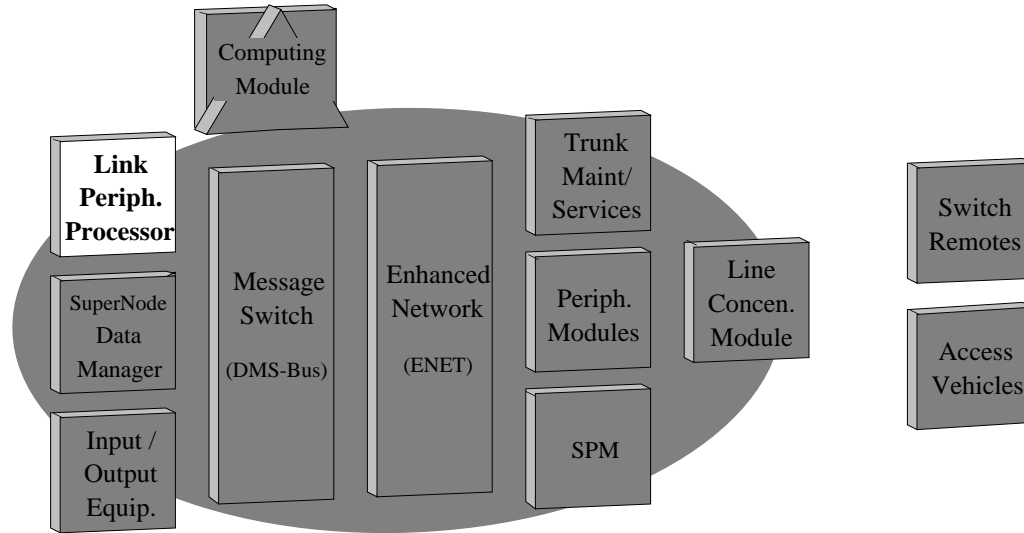

An Assortment of Circuit Packs Enables the Network Provider to Customize LPP Services to Best Meet Current and Future Application Needs

Hardware	Page
Digital Phase Lock-Loop Clock Card	65
8-Megabyte IPF	66
32-Megabyte IPF	67

MODULAR DESIGN EVOLVES WITH THE NETWORK

The Link Peripheral Processor (LPP), a high-capacity, multiservice processor, connects directly to the DMS-Bus (Message Switch). The LPP supports a range of simplification and revenue-generating services, including CCS7-based features, integrated CCS7 nodes, DataSPAN frame relay, ISDN packet data, and emerging voice-recognition and interactive-voice services—as well as streamlined support of network operations support systems (OSSs).

In the future, the versatile LPP can orchestrate file and application processing for advanced network services.

The modular architecture enables the graceful evolution of the network, by allowing the network provider to simply add different circuit packs as LPP-based services are enhanced or demand increases. Its duplicated Local Message Switch routes messages between cards within the same LPP cabinet at 128 million bits per second, increasing the efficiency of the DMS SuperNode by processing intra-LPP messages independent of the DMS-Bus.

MIXED APPLICATION CONFIGURATIONS

The versatile messaging platform offered by the LPP permits multiple applications to share its resources.

The following tables detail verified configuration maximums for different mixes of Application Specific Units (ASUs), as of NA002.

Emphasis on Packet Switching/Frame Relay

Maximum number of:	
<i>All ASU cards</i>	36
CCS7 (SSP-LIU7)	6
DataSPAN (FRIU)	24
DMS Packet Handler (XLIU)	24
Network Interface Unit (NIU)	6

Emphasis on CCS7

Maximum number of:	
<i>All ASU cards</i>	36
CCS7 (SSP-LIU7)	10
DataSPAN (FRIU)	24
DMS Packet Handler (XLIU)	14
Network Interface Unit (NIU)	6

Automated Directory Assistance Service

ADAS ASUs *cannot* be used on the same shelf with FRIUs or XLIUs.

Maximum number of:	
<i>All ASU cards</i>	36
CCS7 (SSP-LIU7)	2
Application Processing Unit (APU)	9
Voice Processing Unit (VPU)	10
Ethernet Interface Unit (EIU)	1
Network Interface Unit (NIU)	6

	<i>present</i>	<i>3Q97</i>	<i>4Q97</i>	<i>1Q98</i>	<i>2Q98</i>	<i>3Q98</i>	<i>4Q98</i>	<i>beyond</i>
Digital Phase Lock-Loop Clock Card								→
8-Megabyte IPF	◇							→
32-Megabyte IPF		LTD	GA NA006					→

◇ = Significant new prerequisite involving this hardware. See text in this chapter for details.

Planned LPP Enhancements

SINCE THE PREVIOUS EDITION . . .

The following products—discussed in the previous issue of the *DMS-100/200 Hardware Planning Guide*—are now available as integral parts of the DMS-100/200 portfolio.

16-Megabyte Processor	Prerequisite for:
NT9X13DD	NA004 All PCLs, for offices with Link Peripheral Processors

As of NA004, the Local Message Switch in all LPPs must have a minimum of 16 megabytes. This requirement can be met through either one of the following configuration options:

- ◆ This NT9X13DD 16-Megabyte Processor, or
- ◆ NT9X14DB 24-Megabyte Memory Card (available only with an existing NT9X13DB processor)

Redundant Power	Prerequisite for:
NTDX16AA and NT9X2825	<i>None currently established</i>

Dual Power Converters on a Link Interface Shelf (LIS) permit continuous power protection to Application Specific Unit (ASU) circuit packs without requiring the provisioning of dual ASUs across multiple half-LIS shelves. This also provides higher availability by protecting against a possible failure of a single power converter for ASUs such as LIU7s, XLIUs (X.25/X.75 Link Interface Units), and FRIUs (Frame-Relay Interface Units).

PLANNED ENHANCEMENTS

Digital Phase Lock-Loop Clock Card	Prerequisite for:	Available
NT9X53AD	<i>None currently established</i>	<i>NOW</i>

For enhanced system operation and CCS7 reliability and robustness, NT9X53AD provides a dual-frequency single-oscillator clock system.

Value

- **Enhances switch performance**—The diagnostic circuitry of the single-oscillator clock system enhances fault detection and trouble isolation to minimize the possibility of outages. Re-engineered clock and frame pulse error checkpoints improve the detection of corrupted or degraded signals.
- **Refines “synch” generation**—The clock’s design reduces the probability of phase shift or phase jitter, for enhanced reliability. The smallest detectable phase error is around 30 nanoseconds compared to near 100 nanoseconds in the existing clock card.
- **Fine-tunes operations, administration, maintenance, and provisioning (OAM&P)**—A new light-emitting diode (LED) provides new OAM&P capabilities designed to help craftspersons complete maintenance tasks correctly and in a shorter amount of time.

Drivers

As network providers introduce more and more digital services, the precise synchronization of digital signals among network nodes becomes increasingly important. The new Digital Phase Lock-Loop Clock card will support Stratum 2 level operation, to enhance high-volume CCS7 messaging.

Transition Plan

Since NA005, the more robust single-oscillator clock system (NT9X53AD) can be used in place of the two-oscillator clock system (NT9X53AC). There are no currently established requirements involving the use of NT9X53AD on the LPP. See “Digital Phase Lock-Loop Clock Card” in the “Message Switch” chapter for information on how this same hardware can be used for the DMS-Bus.

For More Information

- *Feature Planning Guide 1995-1996*; page 69 (500004.11/01-95)

8-Megabyte IPF	Prerequisite for:	Available
NTEX22BB <i>Also supported: NTEX22BA that has been upgraded in the field</i>	NA004 NRC Items and Routeset Expansion	<i>Now</i>
	NA005 DMS-100 SSP with more than 2,000 interoffice trunks	
	NA006 All PCLs	

The NTEX22 circuit pack series now offers an 8-Megabyte Integrated Processor and Frame Bus Interface (IPF) circuit pack (NTEX22BB). By providing twice the memory of earlier versions, this flexible card supports high-demand LPP-based applications that use Application Specific Unit (ASU) hardware, such as the CCS7 Link Interface Unit (LIU7) for CCS7 messaging.

Value

- **Supports NRC implementation**—Implementation of Network Reliability Council (NRC) Items can help improve network performance by providing better error detection and enhancing automatic recovery from problems, particularly during faults and traffic congestion, to help relieve stress on the signaling network.
- **Permits routeset expansion**—By providing the processing overhead required for external routing capabilities, the DMS-100 SSP can expand the maximum number of routesets from 255 to 2,047. This increase provides new flexibility and connectivity to CCS7 networking.
- **Offers expanded processing power**—This vintage has twice the on-board memory offered on the earlier “AA” card, offering sufficient overhead for the enhanced network reliability features offered by NRC Items and other high-throughput CCS7 network enhancements in NA004 and beyond.

Drivers

As different networks become more dependent upon each other for the delivery of vital service, billing, and maintenance activities, it becomes more critical that the CCS7 network stays reliable and available. The implementation of recently issued NRC Items enhances the accuracy and robustness of the signaling network as a whole—and support a steadily increasing range of CCS7-based services, such as Network Centrex, CLASS, ISDN, Enhanced 800, Private Virtual Networking, and an expanding array of Advanced Intelligent Network (AIN) database-inquiry services.

Transition Plan

As part of the LIU7, this circuit pack replaces the Link General Processor NT9X13CA and F-Bus Interface NT9X75AA. Either the NTEX22BB—or an NTEX22BA upgraded in the field—is required for PCLs built from NA006 and higher and for the following features in the DMS-100 SSP, all of which are not supported on Message Switch and Buffers for CCS7 (MSB7s) or 4-Megabyte LIU7s:

- ◆ Network Integrity Items (software TEL00009, now available).
- ◆ CCS7 SSP Routeset Expansion to 2,047 routesets (software TEL00004, now available). External Router ASUs are also required for this expansion.

- ◆ In NA005, any DMS-100 SSP provisioned with 2,500 or more interoffice trunks.
- ◆ In NA006, all PCLs require NTEX22BB.
- *8-Mbyte LIU7 Recommended for CCS7 Services; Product/Service Information* bulletin (50049.17/08-95 Issue 6)

For More Information

32-Megabyte IPF	Prerequisite for:	Available
NTEX22CA	<i>None currently established</i>	LTD: 3Q98 GA: 4Q98 NA006

The NTEX22 circuit pack series is scheduled to offer a new Integrated Processor and Frame Bus Interface (IPF) circuit pack, NTEX22CA, for emerging CCS7-intensive applications.

Value

- **Performance expansions**—The memory capacity of the IPF pack expands from 8 megabytes to 32 megabytes, with a processor upgrade to the Motorola MC68060, to offer the speed and capacity requirements of emerging revenue-generating services, such as those built on GR-based AIN capabilities.
- **Revenue-generating ISDN feature enhancements**—Expanding the capacity of the LIU7 can potentially increase the maximum number of simultaneous ISDN data calls from around 2,000 (with the NTEX22BB) to approximately 8,000.
- **Capital investment savings**—The expanded capacity of the IPF can result in deferring requirements for additional hardware in some situations.

Drivers

To support the projected speed and performance requirements for National ISDN-2/3 involving the LPP, such as packet and frame relay applications, an expansion of the on-board memory for the Integrated Processor and Frame Bus Interface circuit pack may be necessary, depending on the office. Aside from expanded memory, NTEX22CA also introduces a next-generation processor that easily accommodates projected real time demands into the next century, as well as approximately three times the throughput of current processors for data packets per second (dpps) traffic.

Transition Plan

As a member of the NTEX22 family of IPF circuit packs, NTEX22CA is planned to be used for specific applications that require added processing power, such as high-traffic packet services. There are no currently established requirements involving the 32-Megabyte IPF on the DMS-100/200 platform.

DMS SuperNode Data Manager (SDM)

A dedicated server/Element Manager that streamlines operations, administration, maintenance, and provisioning (OAM&P) capabilities for DMS SuperNode systems and associated advanced services over a high-speed TCP/IP interface.

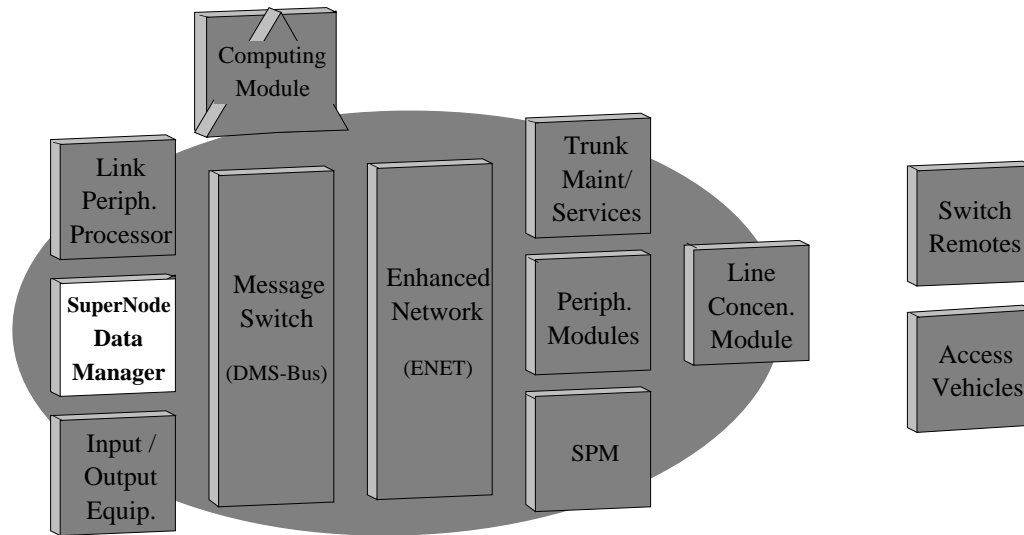

A Dedicated OAM&P Platform Helps Lower Cost of Ownership

Hardware	Page
DMS SuperNode Data Manager	70

DELIVERS COMPETITIVE ADVANTAGES TO PROVIDERS

The operations environment is increasingly difficult for network providers to manage. The complexity of switch operations increases as new services become more complicated and multivendor equipment becomes more common. This lengthens the time required to monitor performance, correct faults, respond to subscriber changes, and introduce new technologies. In the face of other pressures—such as a trimmed work force and heightened competition—there is increased need for more efficient operations that reduce the time and cost requirements of operations, administration, maintenance, and provisioning (OAM&P) procedures and enable more rapid deployment of new revenue-generating services.

Nortel is responding to these challenges by offering leading-edge OAM&P and billing software applications designed to help reduce the life-cycle costs of the DMS SuperNode. These new high-throughput applications can enhance the network provider’s service quality, interwork with next-generation operations systems, and help reduce operating costs.

The new OAM&P applications require high-speed, high-bandwidth connections between the DMS system, technicians, and the operations support system (OSS). By using a dedicated server with high-speed LAN/WAN connectivity, OAM&P processing capacity on the switch is enhanced—with associated gains in maintenance and billing capabilities.

The dedicated server for OAM&P processing is called the SuperNode Data Manager (SDM). This high-performance PowerPC-based platform offers the computing power and robustness needed to support the full array of OAM&P and billing applications with superior performance and reliability.

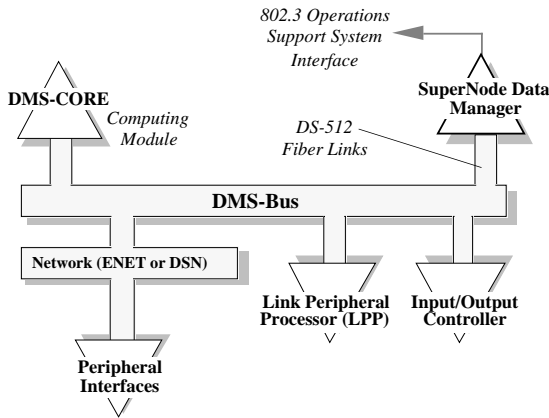

The SDM is Fully Integrated into the DMS SuperNode Architecture with Direct DMS-Bus Fiber Links

Evolves with the Evolving Network

Bellcore guidelines (such as TA-1294), cost-reduction pressures, and emerging industry standards all contribute to the network-wide simplification of OSSs. Applications on the SDM complement OSS evolution and improve the OSS operations fit for a DMS switch, following the Element Management function in the Telecommunications Management Network (TMN) model.

Streamlines OAM&P

Sophisticated OAM&P applications provide processed, intelligent data through industry-standard interfaces to significantly reduce the time and effort required to complete monitoring, fault isolation, provisioning, and other OAM&P tasks. Graphical User Interfaces (GUIs) further enhance switch technician productivity with intuitive, point-and-click operations that reduce training requirements.

Initial applications include:

- ◆ *High-Speed Log Delivery* to operations support systems helps eliminate lost logs with a high-speed TCP/IP link.
- ◆ *Enhanced Terminal Access* permits switch technicians at any location to conduct fast, multiple, simultaneous, and secure Maintenance and Administration Position (MAP) sessions for a DMS switch through a wide area network.
- ◆ *Exception Reporting* correlates DMS logs prior to transmitting them to the operations support system. By monitoring log messages and traffic data, this application delivers “SMART” action-oriented messages, based on the knowledge base programmed into an “Expert System.”
- ◆ The accounting management applications support the projected billing expansion of Automatic Message Accounting/Data Networking Standard (AMADNS) deployment. The new architecture give the network provider greater flexibility over billing, and the new *AMADNS Data Server* on the SDM offers the speed and control needed to efficiently handle the longer record lengths and higher quantity of call records.
- ◆ The new *DMS Data Management System* streamlines DMS SuperNode switch translation and provisioning data management—through a high-speed machine-to-machine interface, an enhanced product rules base, and an easy-to-operate graphical user interface.

The SDM offers
—savings in the cost of ownership through many time-saving features, including simplified commands, unified performance data, and other productivity enhancing capabilities.

DMS SuperNode Data Manager (SDM)	Prerequisite for:	Available
Fault-tolerant version NTRX50FA	<i>None currently established</i>	LTD: 3Q97 GA: 4Q97 NA006

The fault-tolerant SDM adds new efficiencies and state-of-the-art reliability to value-added OAM&P processing. This new design features duplicated processors and mirrored storage. The separate processor and disk domains operate in “match sync” mode. If the active processor components encounter a fault, the second processor assumes control in milliseconds—promoting no loss of service.

With disk mirroring, the SDM stores identical copies of application data on shadowed disk drives. Should the SDM suspect a fault on the primary disk, SDM data is safely available for access on the secondary drive.

The Ethernet interface is also fully redundant, appearing as a single IP address to the OSSs—while providing a higher level of availability than other systems.

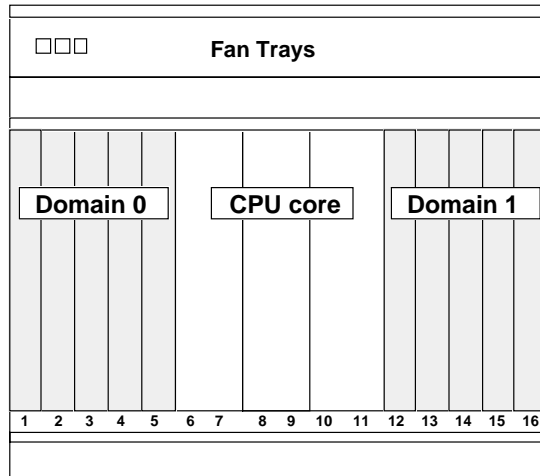

***Duplicated Domains and Disk Mirroring
Help Prevent Loss of Valuable Data***

Value

- **Reduces DMS SuperNode cost of ownership**—Applications on the SDM help reduce the costs of switch operation while helping to speed to market new, more complex services. *Exception Reporting* can significantly simplify the maintenance of the DMS SuperNode by filtering and correlating system logs. *AMADNS Data Server* provides the speed and control needed for the network provider to fully benefit from near real time delivery of enhanced call records.
- **Offers an open machine-to-machine interface for simplifying data modifications and queries**—This intelligent interface, available with the *DMS Data Management System* application, features robust data initialization and synchronization, plus fast data upload to upstream OSS databases.
- **Helps to increase craftsperson productivity**—To streamline the maintenance of multiple DMS systems, *Enhanced Terminal Access* enables an authorized user to conduct multiple Maintenance and Administration Position (MAP) sessions to different DMS SuperNodes equipped with SDMs, simultaneously, in different windows on the same workstation.

The optional *DMS Data Management System* uses a service-based point-and-click graphical user interface (GUI), with intuitive screen layouts, to replace existing syntax-intensive commands to manage switch data. The GUI's basic editor and data browser interworks with an open machine-to-machine interface so the craftsperson can make data modifications and queries quickly and easily.
- **Provides LAN-based security**—The use of industry-standard security and password encryption in all the SDM and OSS interfaces addresses the often-overlooked need for security in a LAN/WAN communications network. These enhanced security capabilities help protect all network elements from malicious access.

Drivers

Competitive pressures, regulatory changes, and subscriber demands are driving service providers to reduce the costs of operating their networks while speeding to market new, more complex services. Maintaining and provisioning sophisticated services with a reduced work force requires OAM&P capabilities that can simplify the complexity of deploying and maintaining new services.

Transition Plan

There are no currently established requirements involving the SDM or any of its applications.

Input/Output Equipment (IOE)

The fundamental serial interface between the DMS SuperNode and external equipment.

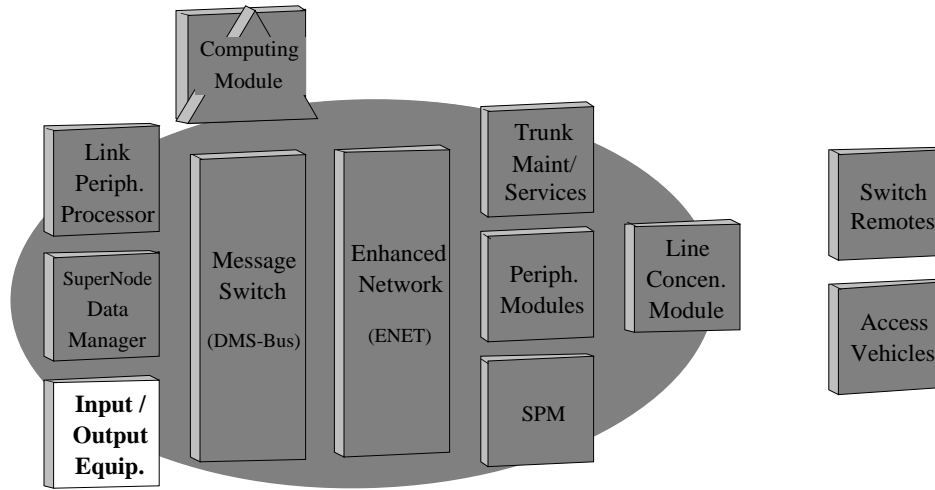

The IOE and New IOM Frames Interface External Devices to the DMS SuperNode

Hardware	Page
Enhanced Multi-Protocol Controller	73
1-2 Gigabyte Disk System for DPP/BMC	74
Input/Output Module (IOM)	75

processors, and terminals such as the Maintenance and Administration Position (MAP).

To reduce operating costs and valuable frame space, the new Input/Output Module (IOM) combines the capabilities of an entire Input/Output Controller shelf—including an optional digital audio tape (DAT) drive—into one circuit pack. This compact offering replaces the functionality of the Input/Output Controller (IOC), disk drive/tape drive units, and Enhanced Multi-Protocol Controller (EMPC)—with a power reduction of about 10:1 over these separate components. See page 75 for more information about the IOM.

FOR SERIAL DATA COMMUNICATIONS

This hardware serves as a buffer and intelligent interface to external devices for serial data communications with the DMS SuperNode. Input/output devices include printers, disk drives, modems, magnetic tape drives, billing

	Present	3Q97	4Q97	1Q98	2Q98	3Q98	4Q98	beyond
Enhanced Multi-Protocol Controller								➔
1 - 2 Gigabyte Drives	Avail. for DPP	BMC GA						➔
Input/Output Module (IOM)		LTD		GA NA006				➔

Planned IOE Enhancements

PLANNED ENHANCEMENTS

Enhanced Multi-Protocol Controller	Prerequisite for:	Available
NT1X89BB	<i>None currently established</i>	<i>Now</i>

For data communications that exceed 9600 bits per second, the DMS SuperNode relies on the Enhanced Multi-Protocol Controller (EMPC, NT1X89BB). Also known as the High Speed MPC, this hardware supports simultaneous operation of two programmable RS-232C ports for operation up to 19.2 kilobits per second (kbps).

Value

- **High throughput**—The EMPC supports incremental delivery of software. This non-disruptive service offers reliable, defect-free software delivery that can significantly reduce the interval to deploy features and services.
- **Superior flexibility**—The EMPC allows simultaneous operation of two ports at the maximum rate of 19.2 kbps for asynchronous communication and up to 64 kbps for synchronous communication. As well, this controller can be used with X.25 interface applications to an operations system.
- **Cost-saving compatibility**—The EMPC is backwards compatible with the original MPC, with twice the throughput capacity of the NT1X89AA.

Drivers

The Enhanced Multi-Protocol Controller offers enhanced levels of survivability, transmission integrity, and switch integration for the network provider requiring “value-added” data communications up to 19.2 kbps. Its support of incremental software delivery accelerates the deployment of new features cost-effectively.

Transition Plan

An EMPC (BA or BB) is required for ISDN TL-1 testing using X.25 links to an operations system. This card ships with all initial systems and with expansions in existing offices to replace two kinds of circuit packs, both currently Manufacture Discontinued:

- Earlier EMPC card (NT1X89BA)
- Simplified Message Desk Interface (SMDI) card (NT1X67FA)

For More Information

- *Northern Telecom Publications 297-1001-015*

1 - 2 Gigabyte Drive System for DPP/BMC	Prerequisite for:	Available
<i>various codes</i> <i>(see Product/Service Update article, identified at bottom of page, for detailed list of codes)</i>	<i>None currently established</i>	FOR DPP: <i>Now</i> FOR BMC: LTD: 2Q97 GA: 3Q97

To meet the increased demands on billing systems, new upgrade kits—with large-capacity disk drives—can triple record-storage capacities and enhance reliability. These kits apply to:

- ◆ Integrated Distributed Processing Peripheral (DPP) systems [for all in-service systems]
- ◆ External Billing Media Converter (BMC) systems [for most BX.25 and Bisync systems]

For upgrades, the network provider has the choice of either a 1 or 2 gigabyte drive. These same larger-capacity drives are standard components in new or replacement systems.

Value

- **Extensive storage**—So the network provider can store more call records, this new SCSI-based drive offers either one or two gigabytes of usable storage. The exact data storage requirement is determined by a number of local practices, such as frequency of polling, duration of Automatic Message Accounting (AMA) retention, and popularity of record-intensive services.
- **Reduced hardware**—The new drive's integrated design eliminates the existing requirement for a separate drive controller pack, offering economies in shelf space, sparing, power, and cooling.
- **Superior performance**—This upgrade doubles the disk drive mean time between failures—calculated to be in excess of 300,000 power-on hours.
- **Simple upgrade**—Each drive features modular construction with all assemblies field replaceable by the network provider. All changes are internal to the DPP/BMC, and no external connections need to be upgraded.
- **Enhanced monitoring**—Also available are new DPP/BMC alarm cables providing enhanced alarm reporting and identification. This enhancement is standard with new systems and available as an upgrade for existing systems.

Drivers

Several factors have expanded call records beyond traditional memory requirements, including additional AMA data, larger extension modules, and expanded usage-sensitive billing (such as local metered service). The expansion of record-intensive services built on ISDN and AIN and the implementation of special processing for fraud detection and AMA segregation add to the increased high data requirements. Current systems are keeping pace, but an expansion of storage capacity will be needed in some systems to ride the curve of subscriber demands.

Transition Plan

A new 1- or 2-gigabyte upgrade kit replaces the current disk subsystem. The existing drive assembly, interface packs, crossover packs, cables between the crossover packs, and the drives in the system are replaced at the same time.

Minimum software level: BCS36.

There are no currently established requirements involving this upgrade, available through field upgrade kits. The new hardware is *not* available on older systems with Plexiglas doors. Kits for existing non-turbo DPP systems offer conversion to turbo polling speeds (maximum 56 kilobits per second).

For More Information

- *New DPP/BMCs Increase Billing Reliability, Performance; Product/Service Update article (50049.17/05-96).*

Input/Output Module (IOM)	Prerequisite for:	Available
	<i>None currently established</i>	LTD: 3Q97 GA: 1Q98 NA006

The capabilities of an entire Input/Output Controller shelf—including the tape drive—are currently being designed into one circuit pack. Housed in the new Integrated Services Module (ISM) shelf, the Input/Output Module (IOM) significantly reduces initial investment costs, while offering continued savings in operating expenses for power, cooling, and spares.

Value

- **Frees up valuable frame and floor space**—This compact design frees up significant space for use by other hardware modules. This solution replaces the current functionality of the Input/Output Controller (IOC), disk drive/tape drive units, and Enhanced Multi-Protocol Controller.
- **Offers new functionality**—The IOM enhances data communications by supporting up to 16 ports per card—each capable of providing 28.8 kbps synchronous or 64 kbps synchronous communications. Enhancing data communications has the potential to fine-tune many DMS SuperNode capabilities, such as the MAP, centralized alarms, operational measurement polling, voice mail, Meridian Automatic Call Distribution, and Enhanced 911. The IOM also offers an optional digital audio tape (DAT) drive for reduced-cost removable storage of up to 1.3 gigabytes.
- **Simplifies engineering and installation**—The IOM supports all current input/output applications, and coexists with existing frames and components (including Distributed Processing Peripherals and 9-track Magnetic Tape Drives). Installation is simplified with new port configuration flexibility, cable reduction, and streamlined engineering.
- **Reduces operating costs**—The compact IOM offers a significant power reduction of 10:1 over similar components in the IOE. The simplicity of design also contributes to greater reliability, lower electromagnetic interference, and quicker fault isolation. Its optional disk provides higher capacity (2 gigabytes) on a single, integrated device for Automatic Message Accounting, Station Message Detail Recording, operational measurements, journal files, and emerging applications relying on fixed-media storage.

Drivers

Cost containment pressures—fueled by increased competition, tariff limits, and regulatory demands—have network providers seeking new ways to lower both investment and operating expenses. The economies of significantly streamlined input/output capabilities favorably impact the network provider's bottom line.

Transition Plan

There are no currently established requirements involving the IOM. Currently, there are two versions of this card planned for availability:

- ◆ Single-slot card with 16 ports.
- ◆ Two-slot card with disk drive unit, DAT drive, or both.

References

Use the information in this chapter to quickly find the information you need in this edition of the *DMS-100/200 Hardware Planning Guide*.

Hardware	Page
Hardware Listed by Ordering Code	Below
Abbreviations and Acronyms	79
Exhaustive Index	83

Remember to cross-reference the tables found at the beginning of this document for:

- ◆ Minimum hardware baselines (vi-vii)
- ◆ Optional feature configurations (viii-ix)
- ◆ New and discontinued hardware (x-xi)
- ◆ Optional hardware for modernizing the network (xii)

Hardware Listed by Ordering Code

Only hardware that showed a hardware ordering code appears in the following list. Not all hardware discussed in this document had an ordering code listed, either because a given component (1) has multiple codes, or (2) is pending the assignment of an ordering code. Use the *Exhaustive Index* (starting on page 83) for more detailed cross-referencing. Entries in **bold typeface** indicate pages that discuss the particular equipment in detail.

NT0J42BA	ESTU Master Module	25
NT0J43AA	ISDN Test Module	25
NT0X50	Filler Pack	29
NT1X67FA	Simplified Message Desk Interface (SMDI) card	73
NT1X80	Enh. Digital Recorded Announcement Machine (EDRAM)	24, 25
NT1X81AA	Conference Trunk Module (CTM)	25
NT1X89BB	Enhanced Multi-Protocol Controller (EMPC)	viii, 73
NT2A	Outside Plant Access Cabinet OC-1 Module	53
NT3X09BA	Metallic Test Access Module	26
NT3X82	Office Alarm Unit (for MTM and ISM)	x, 25
NT3X89	Enhanced Alarm System	25
NT4X45AA	Enhanced Digital Test Unit (EDTU)	x, 27
NT6X02	SCM-100A (SMA)	x, 30, 31
NT6X05DA	ISDN Line Drawer for Remotes (ILDR)	ix, 54
NT6X17BA	World Line Card, Type A	viii, x, 45
NT6X18BA	World Line Card, Type B	x, 45
NT6X50AB	DS-1 Interface card	viii, ix, 52, 54

NT6X51 Line Concentrating Module Processor

ix, 45, **46**, 54

NT6X69AD	Message Protocol and Tone Generator	viii, 30
NT6X80BB	Ring/Pad Card	29
NT6X86AB	A-B Bit Message card	29
NT6X92EA	Global Tone Receiver	39
NT7X05AA	Peripheral/Remote Loader	viii, ix, 33
NT7X76BA	Wideband Test Access Panel	26
NT9X10AA	Series 50 / Series 60 Processor	vi-vii, x, 9, 11-12, 13 , 14-15
NT9X10BA	Series 70 Processor	x, 11-13, 14 , 15-17
NT9X10CA	Series 70 Extended Memory Processor	vii, x, xii, 9, 11-13, 14-15
NT9X12AD	Port Card	vii, 13
NT9X13CA	Link General Processor	66
NT9X13DD	16-Megabyte Processor (for MS/LPP)	19, 64
NT9X13FA	4-Megabyte Processor (for ENET)	22
NT9X13KA	16-Megabyte Processor (for ENET)	vi, 22
NT9X13NA	16-Megabyte Processor (for DMS SuperNode SE systems)	19
NT9X14DB	24-Megabyte Memory Card	vi-vii, 13, 19, 64
NT9X14EA	96-Megabyte Memory Card	vi-vii, 12 , 13, 15
NT9X26	Remote Terminal Interface	vii, 13
NT9X2825	Redundant Power Interface Backplane	64
NT9X44AB	System Load Module II	x, 12
NT9X44AD	System Load Module III	vi, x, 12
NT9X53AD	Digital Phase Lock-Loop Clock Card	19, 65
NT9X75AA	Frame Bus Interface	66
NTAX74AA	16-Megabyte Processor	vi-ix, 33, 34-35 , 55
NTAX78AB	Enhanced Time Switch	viii, 30
NTBX01	Enhanced ISDN Signaling Preprocessor (EISP)	vi-vii, 29, 32, 35
NTBX02BA	Enhanced D-Channel Handler (EDCH)	ix, 29, 32
NTBX34BC	ISDN Line Concentrating Module Processor	29
NTDX16AA	Redundant Power Pack (for LPP)	64
NTEX17AA	Dual-slot 1-Meg Modem Line Card	47
NTEX17BA	Single-slot 1-Meg Modem Line Card	47
NTEX22BA	8-Megabyte Integrated Processor and Frame Bus (IPF)	vi, viii, 66
NTEX22BB	8-Megabyte Integrated Processor and Frame Bus (IPF)	vi, viii, ix, 6, 7, 66-67

NTEX22CA	32-Megabyte Integrated Processor and Frame Bus (IPF)	67
NTEX35AA	1-Meg Modem (customer premises equipment)	46-47
NTFX40AA	Integrated Services Module (ISM) cabinet	25
NTFX40BA	Integrated Services Module (ISM) frame	25
NTFX40EA	Cabinetized Metallic Test Access (CMTA)	26
NTFX40FA	a Metallic Test Access Equipment (MTAE)	26
NTEX54AA	Data-enhanced Bus Interface Card (DBIC)	47
NTFX55BB	NAV Controller Bay	x
NTMX71AA	Bus Terminal Paddleboard	29
NTMX75BA	Matrix card	viii
NTMX76	Messaging card	viii, 52
NTMX77AA	Unified Processor (UP)	ix, 29
NTMX81AA	DS-1 Interface	ix, 54
NTRX50FA	DMS SuperNode Data Manager (SDM)	iii, ix, 68-71

Abbreviations and Acronyms

The following pages list abbreviations and acronyms that appear throughout this document.

A		C	
ACD	Automatic Call Distribution	CAU	Code Division Multiple Access Application Unit
ADAS	Automated Directory Assistance Service	CCS	Century Call Seconds
ADSI	Analog Display Services Interface	CCS7	Common Channel Signaling No. 7 (same as SS7 network)
ADSL	Asymmetric Digital Subscriber Line	CDMA	Code Division Multiple Access
AIN	Advanced Intelligent Network	CIU	Code Division Multiple Access Interface Unit
AMA	Automatic Message Accounting	CLASS	Custom Local Area Signaling Services
AMADNS	Automatic Message Accounting Data Networking Standard	CM	Computing Module
AMPS	Advanced Mobile Phone Systems	CMIC	Compute Module Interface Circuit card
APU	Application Processing Unit	CMTA	Cabinetized Metallic Test Access
ASIC	Application-Specific Integrated Circuit	CPE	Customer Premises Equipment
ASU	Application Specific Unit	CTI	Computer-Telephony Integration
ASYNC	Asynchronous	CTM	Conference Trunk Module
ATM	Asynchronous Transfer Mode	D	
B		DAT	Digital Audio Tape
Bellcore	Bell Communications Research	DBIC	Data-enhanced Bus Interface Card
BERT	Bit Error Rate Testing	DCH	D-Channel Handler
BMC	Billing Media Converter	DLC	Digital Loop Carrier
bps	Bits per second	DMS	Digital Multiplex System
BRI	Basic Rate Interface	DPP	Distributed Processing Peripheral
BRISC	BNR Reduced Instruction Set Computing	dpps	Data Packets Per Second
		DRAM	Digital Recorded Announcement Machine
		DS-0, DS-1, DS-30	Digital Signal (levels 0, 1, and 30)

DSCWID Spontaneous Call Waiting
Identification with
Disposition

DSN Double-Shelf Network

DSP Digital Signaling
Processing

DTC Digital Trunk Controller

DTC7 Digital Trunk Controller
for CCS7

DTCI Digital Trunk Controller
for ISDN

DTMF Dual-Tone Multi-
Frequency

DTU Digital Test Unit

E

EAS Enhanced Alarm System

EDAC Error Detection and
Correction

EDC Extended Distance
Capability

EDCH Enhanced D-Channel
Handler

EDRAM Enhanced Digital Recorded
Announcement Machine

EDTU Enhanced Digital Test Unit

EISP Enhanced ISDN Signaling
Preprocessor

EIU Ethernet Interface Unit

EM Extended Memory

EMI Electromagnetic Interference

EMPC Enhanced Multi-Protocol
Controller

ENET Enhanced Network

EOC Embedded Operations
Channel

ESA Emergency Standalone

ESMA Expanded Subscriber Carrier
Module-100 Access

ESMU Enhanced Subscriber Carrier
Module-100 URBAN

ETS Enhanced Time Switch

F

FACET Flexible Advanced Capacity
Engineering Tool

FLIS Fiber Link Interface Shelf

FRIU Frame Relay Interface Unit

FST Full Services Terminal

FTFS Fault-Tolerant File System

G

GA General Availability

GR Bellcore Generic Requirement

GTR Global Tone Receiver

GUI Graphical User Interface

H

HDSL High-Speed Digital
Subscriber Line

HDT Host Digital Terminal

HLR Home Location Register

I

ID Identification

ILDR ISDN Line Drawer for Remotes

IOC Input/Output Controller

IOE Input/Output Equipment

IOM Input/Output Module

IP Intelligent Peripheral *or*
Internet Protocol

IPF Integrated Processor and Frame
Bus Interface

ISDN Integrated Services Digital
Network

ISM Integrated Services Module

ISP Internet Service Provider

ISUP ISDN User Part

ITMS Integrated Traffic Management
System

J

JNET Junctor Network

K

kbps Kilobits per second

L

L2F Layer Two Forwarding
 LAN Local Area Network
 LCM Line Concentrating Module
 LED Light-Emitting Diode
 LGC Line Group Controller
 LGCI Line Group Controller for ISDN
 LIS Link Interface Shelf
 LIU Line Interface Unit
 LIU7 Line Interface Unit for CCS7
 LNP Local Number Portability
 LPP Link Peripheral Processor
 LSSGR Local Access and Transport
 Area Switching System
 Generic Requirements
 LTD Limited availability

M

MAP Maintenance and
 Administration Position
 Mbps Megabits per Second
 MBS Meridian Business Set
 MD Manufacture Discontinued
 MDC Meridian Digital Centrex
 MF Multifrequency
 MHz Megahertz
 MPC Multi-Protocol Controller
 MS Message Switch
 MSB7 Message Switch and Buffer
 for CCS7
 MTAE Metallic Test Access
 Equipment
 MTBF Mean Time Between Failures
 MTM Maintenance Trunk Module
 MTX DMS Mobile Telephone
 Exchange
 MUX Multiplexer

N

NAV Network Applications
 Vehicle
 NGDLC Next Generation Digital
 Loop Carrier
 NI-1 National ISDN-1
 NI-2 National ISDN-2
 NI-3 National ISDN-3
 NIU Network Interface Unit
 NRC Network Reliability Council
 NSS Network Service Solutions
 NTP Northern Telecom Publication

O

OAM&P Operations, Administration,
 Maintenance, and
 Provisioning
 OC Optical Carrier
 OPAC Outside Plant Access
 Cabinet
 OPC Operations Controller
 OPM Outside Plant Module
 OSS Operations Support System

P

PBX Private Branch Exchange
 PC Personal Computer
 PCL Product Computing-Module
 Load
 PCM Pulse Code Modulation
 PCS Personal Communications
 Services
 PEC Product Engineering Code
 PM Peripheral Module
 POTS Plain Old Telephone Service
 PRI Primary Rate Interface
 PRL Peripheral/Remote Loader
 PSI *Product/Service Information
 bulletin*

R		STP	Signal Transfer Point
RAM	Random Access Memory	SWACT	Switch of Activity
RDT	Remote Digital Terminal		
Rel	Release	T	
RES	Residential Enhanced Services	TBD	To be Determined
RISC	Reduced Instruction Set Computing	TCP/IP	Transmission Control Protocol / Internet Protocol
RLCM	Remote Line Concentrating Module	TDMA	Time Division Multiple Access
RSC	Remote Switching Center	TL-1	Transaction Language 1
RSC-S	Remote Switching Center-S	TMN	Telecommunications Management Network
RTIF	Remote Terminal Interface	TOPS	DMS Traffic Operator Position System
S		TR	Bellcore Technical Reference
S/DMS	SONET / Digital Multiplex System	TTT	Transmission Test Trunk
SCM	Subscriber Carrier Module	TTU	Trunk Test Unit
SCM-100A	Subscriber Carrier Module-100 Access (same as SMA)	U	
SCP	Service Control Point	UTR	Universal Tone Receiver
SCSI	Small Computer Systems Interface	V	
SCWID	Spontaneous Call Waiting Identification	VLR	Visitor Location Register
SDM	DMS SuperNode Data Manager	VPU	Voice Processing Unit
SLM	System Load Module	W	
SMA	Subscriber Carrier Module-100A\ (same as SCM-100A)	WAN	Wide Area Network
SMDI	Simplified Message Desk Interface	WLC	World Line Card
SMDR	Station Message Detail Recording	X	
SMS	Subscriber Carrier Module-100S	XA-Core	Extended Architecture Core
SONET	Synchronous Optical Network	xDSL	Digital Subscriber Line [generic designation]
SP	Signaling Point	XLIU	X.25 / X.75 Link Interface Unit
SS7	Signaling System No. 7 (same as CCS7)	XPM	Extended Peripheral Module
SSP	Service Switching Point		

Exhaustive Index

The following pages list the subjects discussed in this document. Page entries appearing in **bold typeface** indicate pages that discuss a topic in detail. Page numbers in *italics* indicate the topic item appears in an illustration.

#

1- and 2-Gigabyte BMC drives **74**
 1-Meg Modem Service iii, **46-47**
 8-Megabyte IPF vi, viii-ix, xi, 6-7, **66-67**
 16-Megabyte processor (NT9X13DD) 19, 64
 16-Megabyte processor (NT9X13KA) vi, **22**
 16-Megabyte processor (NTAX74AA)
 Baseline tables vi, vii
 In Peripheral Modules **34-35**
 In RSC-S **55**
 Peripheral/Remote Loader viii-ix, 33
 Requires EISP 35
 TR-303 support ix
 24-Megabyte Memory card vi, vii, 13, 19, 64
 32-Megabyte IPF (in LPP) xii, **67**
 96-Megabyte Memory card vi, vii, **12**,
 13, 15
 802.3 (Ethernet) interface 46, 53, 60

A

Access Vehicles, chapter **56-61**
 AccessNode iii, 30, 31, 36-38, 53, **57**, 58
 AccessNode Data Direct 58-61
 AccessNode Express xii, 58, **60-61**
 ACD 9, 75
 Adaptive line cards iii, 36, 57, 61
 ADAS, card configuration in LPP 63
 ADSI 30, 52
 ADSL 47, 59
Advanced Intelligent Networking, see AIN
Advanced Mobile Phone Systems, see AMPS

AIN, service supported i, xi, 9, 10, 12,
 14-15, 17, 35, 66-67, 74
 AMA 69-70, 74-75
 AMADNS Data Server (see also SDM)
 ix, 69-70
 AMPS 9
 Analog Display Services Interface (ADSI)
 30, 52
 Application Specific Unit (ASU)
 External routers 7
 Configuration maximum tables 63
 Requires 8-Megabyte IPF 66
 With Redundant Power 64
 Asymmetric Digital Subscriber Line (ADSL)
 47, 59
 Asynchronous Transfer Mode (ATM)
 ii, iii, 40-42, **43**, 58-60
 Automated Directory Assistance Service
 (ADAS) 63
 Automatic Call Distribution 9, 75
 Automatic Message Accounting (AMA)
 69-70, 74-75

B

Baseline tables vi-vii
 Basic Rate Interface (ISDN) 30, 36,
 54, 60
 Bellcore i, 26, 36-37, 56, 69
 Billing Media Converter (BMC) disks **74**
 Black Box Fraud Prevention ix
 BRI ISDN 30, 36, 54, 60
 Broadband
 Network ii, iii
 Service support 21, 36-37, 43, 56

C

Cabinetized Metallic Test Access (CMTA) **26**

Call Forwarding / Call Waiting 9

Caller name identification service 9, 45, 55

CCS7

- External routers viii, **7**
- CCS7 links affect hardware baseline 23
- Service support 29, 50
- Through Link Peripheral Proc. 62-67
- With NT9X53AD Clock Card 65

CDMA 9

Centrex, see MDC

Channel banks, see Integrated channel banks

CLASS, service support viii, 7, 9, 29, 45, 52, 56, 66

Clock card **19, 65**

CM, see Computing Module

CMIC 18

CMTA **26**

Code Division Multiple Access (CDMA) 9

Computer-Telephony Integration, on DMS-100 Wireless 9

Computing Module (CM)

- Baseline vi, vii
- Chapter **10-17**
- Freed up by Message Switch 18
- Freed up by SDM 68
- Freed up by SPM 41

Computing Module Interface Circuit (CMIC) 18

Conference Trunk Module (CTM) **25**

Congestion, avoidance ii, iii, 23, 44, 58-61

Cornerstone 36, **57**

Credit Card Calling 9

CTI, on DMS-100 Wireless 9

Custom Local Area Signaling Services (CLASS) viii, 7, 9, 29, 45, 52, 56, 66

D

D4 Foreign Exchange Signaling 38

DAT 72, 75

Data communication with DMS SuperNode

- Serial interface viii, 72-75
- High-speed interface 68-71

Datapath 52

DataSPAN 62, 63

Data-enhanced Bus Interface Card 47

DBIC 47

Digital Audio Tape (DAT) 72, 75

Digital Carrier Module (DCM) viii

Digital Loop Carrier (DLC) 26, 28, 36-37, 39

Digital Phase Lock-Loop Clock Card **19, 65**

Digital Signaling Processing (DSP) 40

Digital Subscriber Line (DSL) iii, 47

Digital Test Access (DTA) viii, 30

Digital Trunk Controller 6, 9, 29

Distributed Processing Peripheral (DPP)

- New disk drives 74
- Supported by IOM 75

DLC, see Digital loop carrier

DMS Automatic Call Distribution 9, 75

DMS Data Management System 69-70

DMS Packet Handler 63

DMS SuperNode SE vi, vii, 9, 12-14, 23

DMS-1 URBAN viii, 30, 53

DMS-10 47, 56

DMS-100 Wireless **8-9**

DMS-200 Access Tandem vi, 4, **6-7**, 17

DMS-Bus, see Message Switch

DMS-MTX system 8-9

DPP, see Distributed Processing Peripheral

DS-1 Interface card viii-ix, 54

DS-512 fiber links 18, 21, 69

DSL iii, 47

DSN, replaced by ENET xi, 69

DTC / DTCl / DTC7 6, 9, 29

- E**
- Echo cancellation, integrated 40
 - EDC viii, 50-51, **52**
 - EDCH, see Enhanced D-Channel Handler*
 - EDRAM 24, 25
 - EDTU x, **27**
 - EISP, see Enhanced ISDN Signaling Preprocessor*
 - Embedded Operations Channel (EOC) 34
 - Emergency Standalone (ESA) 48-50, 54-55
 - EMPC
 - Data communications viii
 - Description **73**
 - IOM supplants EMPC 72
 - ENET
 - Baseline vi
 - Chapter **20-23**
 - Single-shelf ENET 23
 - Supported with XA-Core 17
 - Upgrade to DMS SuperNode system 23
 - With SPM 42-43
 - Enhanced 800 7, 66
 - Enhanced 911 75
 - Enhanced Alarm System (EAS) **25**
 - Enhanced D-Channel Handler (EDCH) ix, 29, 30, **32**, 54
 - Enhanced Digital Recorded Announcement Machine (EDRAM) 24, 25
 - Enhanced Digital Test Unit (EDTU) x, **27**
 - Enhanced ISDN Signaling Preprocessor (EISP) vi, vii, 29, 35
 - Enhanced Multi-Protocol Controller, see EMPC*
 - Enhanced Network. see ENET*
 - Enhanced SCM-100U (ESMU) viii-ix, **30**, 32
 - Enhanced Terminal Access (also see SDM) ix, 69
 - Enhanced Time Switch (ETS) viii, 30
 - EOC 36
 - ESA 46-48, 54-55
 - ESMA
 - Baseline vi
 - CLASS support viii
 - Description **36-37**
 - Digital Test Access viii
 - Not with PRL viii-ix, 33
 - Replaces SMA x, 37
 - TR-303 support ix, 30, 39
 - With Enhanced Time Switch 30
 - With integrated channel banks **38**
 - With Meridian Business Set **39**
 - ESMU viii-ix, **30**, 32
 - Ethernet interface (IEEE 802.3) 46, 53, 60
 - Ethernet Interface Unit (EIU) 63
 - ETS viii, 30
 - Exception Reporting (see also SDM) ix, 69-70
 - Expanded SCM-100A, see ESMA*
 - Extended Architecture (XA) Core iii, xii, 11, **16-17**
 - Extended Distance Capability (EDC) viii, 50-51, **52**
 - Extended Peripheral Module, see XPM*
 - External routers viii, **7**
- F**
- Flexible Advanced Capacity Engineering Tool (FACET) vi
 - Frame Link Interface Shelf (FLIS) vii, 9
 - Frame relay 58-60, 62-64, 67
 - Full-Service Terminal (FST) 53
- G**
- Global Tone Receiver (GTR) **39**
 - Graphical User Interface (GUI) 69-71

H

Hardware Planning Guide, how to use 4-6

High-Speed Log Delivery 69

Host Digital Terminal (HDT) 61

I

ILDRL ix, xii, 45, **54**

Input/Output Controller (IOC) xi, 69, 75

Input/Output Equipment, see *IOE*

Input/Output Module, see *IOM*

Integrated channel banks 36, **38**

Integrated Service Module, see *ISM*

Integrated Services Digital Network,
see *ISDN*

Integrated Traffic Management System 59

Internet access ii, iii, 23, 35, 38, 44, 47,
54-55, **58-61**

Internet Service Provider ii, 38, 46-47, 58-59

Internet Thruway iii, xii, **58-59**

Intraswitching 48-49

IOC, replaced by IOM xi, 72, 75

IOE

Chapter **72-75**

Data communications viii

IOM replaces IOC xi, 72, 75

IOM

Installed in ISM **75**

Replaces IOC xi, 72, 75

Description 72, **75**

IS-41 Roaming 9

ISDN

Basic rate interface 30, 36, 54, 60

Customer premises equipment x

On access vehicles 56, 61

On DMS-100 Wireless 9

On Rapport 60

On RSC-S 51, 55

Optional feature tables viii

Packet services ix, 32, 62, 67

Testing and troubleshooting **26**

ISDN Line Drawer for Remotes (ILDRL)

ix, xii, 46, **54**

ISDN, services supported 7, 10, 12-15, 22,
29, 32, 35-37, 46, 52, 54, 66-67, 74

ISDN User Part (ISUP) 6

ISM

Houses Input/Output Module (IOM) 75

Replaces MTM/TM x, 25

With EDTU 27

ISP, see *Internet Service Provider*

J

Junctor Network (JNET) 23

L**LCM**

Chapter **44-47**

ISDN LCM 38, 44

ISDN Line Drawer ix, xii, 46, **54**

New processor **46**

With Talk Battery Alarm viii, **45**

LCM Processor ix, 29, **46**, 54

Line Concentrating Module, see *LCM*

Line Group Controller (LGC) 44-46

Link Interface Shelf (LIS) vii, 64

Link Interface Unit, see *LIU*

Link Peripheral Processor, see *LPP*

LIU / LIU7

4-Meg LIU7 replaced by 8-Meg. IPF xi

Configuration maximum in LPP 63

Require 8-Megabyte IPF vi, 66

With 32-Megabyte IPF 67

With Redundant Power feature 64

LNP vii, 9, 15, 23

Local Message Switch (in LPP) 62, 64

Local Number Portability (LNP)

vii, 9, 15, 23

LPP

Baseline vi, vii

CCS7 viii, 7

Chapter **62-67**

Needed for DMS-100 Wireless 9

NRC items viii, ix, 66

Replaces MSB7 xi, 66

M

Magellan Concorde switch iii

Magellan Passport switch iii, 46, 58

Magellan Vector switch iii

Maintenance and Administration Position,
see *MAP*

Maintenance Trunk Module (MTM)
x, 25, 27

Manufacture discontinue
Full support still offered 5
Hardware replacement tables x-xi

MAP 11, 13, 22, 59, 69-70, 75

Matrix card viii

MBS viii, 30, 36, 38-39

MDC
Extended, with EDC 52
Network centrex 7, 66
On access vehicles 56
On DMS-100 Wireless 9
On World Line Card 45
Service supported 35-38

Meridian Business Set (MBS)
viii, 30, 36, 38-39

Meridian Digital Centrex, see *MDC*

Message Protocol and Tone Generator
viii, 30

Message Switch (MS) 17, **18-19**, 62

Metallic Test Access Equipment
(MTAE) **26**

Minimum Configuration tables vi-vii

Mirroring on SDM 70

MS, see *Message Switch*

MSB7, discontinued vii, xi, 66

MTAE **26**

MTM, replaced by ISM x, 25, 27

N

NA00x product releases
NA00x baselines iii-iv
NA00x scheduled availability 5

National ISDN, see *ISDN*

Network Applications Vehicle (NAV) x

Network Interface Unit (NUI) 63

Network management ii, iii, 58-59, 61

Network Reliability Council (NRC)
items viii-ix, 66

Network Service Solutions (NSS) 59

Network switch fabric, see *ENET*

NI-2/3, see *ISDN*

Nortel 1-Meg Modem Service iii, **46-47**

Nortel Online iv

Nortel world wide web site 4

NRC items viii-ix, 66

NUI 63

O

OAM&P
Enhanced switch OAM&P 20, 26-27,
32, 36, 41, 50, 53-54, 58-60, 65
New applications (on SDM) iii, ix, xii,
18, **68-71**

OC-1 SONET Module **53**

OC-3 support iii, 18, 21, 40-41, **42-43**,
60

OC-12 support iii, 36

OC-48, OC-192 support iii

Office Alarm Unit x

One Night Process 11, 22

OPAC/OPM 45, **46**, 54

Operations Support System (OSS)
44, 62, 68-70

Operations, administration, maintenance,
and provisioning; see OAM&P

Operator services (see ADAS and TOPS) 23

Optional Feature tables viii-ix

OSS 44, 62, 68-70

P

PCS i, 8-9

Peripheral Modules

Baseline tables vi

Chapter **28-39**

Optional feature tables viii-ix

Supported by XA-Core 17

Peripheral/Remote Loader (PRL) viii-ix, **33**

Personal Communications Services (PCS)

i, 8-9

Personal Number Service 9

Port card vii, 13

Portfolio Simplification PSI x

Private Virtual Networking 7, 66

PRL viii-ix, **33****R**

Rapport Dialup Switch

Description **60**

With Internet Thruway 58-59

Redundant Power on LPP 64

Remote Digital Terminal (RDT)

28, 31, 36-39, 56

Remote Line Concentrating Module (RLCM)

45, 54

Remote Switching Center-S, see *RSC-S*

Remote Terminal Interface (RTIF) vii, 13-14

Remotes, chapter **48-55**

Residential Enhanced Services (RES) 38

RLCM 45, 46, 54

Routeset expansion viii, 7, 66

RSC-S

Baseline vii

CLASS support viii

ISDN Line Drawer for Remotes ix, 54

NTAX74AA support **55**

With Extended Distance Cap. viii, 52

With 1-Meg Modem Service 46

RSCE **51**

RTIF vii, 13-14

S

S/DMS TransportNode iii, 61

SCM family xi, 28-29

SCM-100A, see *SMA*

SCM-100S (SMS) 29

SCM-100S Remote (SMS-R) 29

SCP 7

SCWID/DSCWID viii, 30, 52

SDM iii, ix, xii, 18, **68-71**

Security 58-60, 69, 71

Series 20 processor x, 11, 14

Series 30 processor x, 11

Series 40 processor x, 11

Series 50 processor vi, vii, 11-13

Series 60 processor x, 9, 11-12, **13**, 14, 15

Series 70 Extended Memory

vii, xii, 9, 11-13, **14-15**Series 70 processor x, 11-13, **14**, 15, 17

Service adaptive line cards iii, 36, 57, 61

Service Control Point (SCP) 7

Service Switching Point (SSP) 4, 7

Signaling Network, see *CCS7*

Simplified Message Desk Interface (SMDI)

card 73

SL-100 46-47

SLM III vi, x, **12**, 16-17

SMA (see also ESMA)

Baseline vi, viii

Digital Test Access support viii, 30

Manufacture discontinued x, **31**

Not with Peripheral/Remote Loader viii

TR-303 in NA006 ix

SMDR (see also Simplified Message Desk

Interface) 75

SMS, SMS-R 29

SONET ii, iii, 22, 42-43, 53, 61

SPM iii, xii, 21, **40-43**

Spontaneous Call Waiting Display

(SCWID/DSCWID) viii, 30, 52

SS7, *see* CCS7

SSP, DMS-100 system as 4, 7

Stratum synchronization 18, 19, 65

STS-1 support iii, 41, **43**, 53

Subscriber Carrier Module (SCM) family
xi, 28-29

SuperNode Data Manager (SDM) iii, ix, xii,
18, **68-71**

Switch remotes, chapter **48-55**

System illustration v

System Load Module (SLM) vi, x, **12**, 16-17

T

Talk Battery Alarm viii, 45

Tandem, see DMS-200 Access Tandem

TCP/IP 68-71

TDMA 9

Telecommunications Management Network
(TMN) model 69

Telecommunications Act of 1996 i, 38

Telecommuting (see also Work-at-home)
ii, 55, 60

Time Division Multiple Access (TDMA) 9

TL-1 standard 73

TMN model 69

Token ring 60

TOPS viii, 29

TR-08 support 28, 30, 56, 61

TR-303 support ix-x, xii, 28-31, 36-39,
56-60, 56, 58-61

Traffic Operator Position System (TOPS)
viii, 29

Trunk Maintenance/Services

Analog Interface Module x

Chapter **24-27**

SIM replaces MTM x

Trunk test circuits x

U

Unified Processor, see XPM PLUS

Universal Tone Receiver (UTR) 39

V

Visual Screen List Editing 30

Voice-activated services i, 9, 39, 62

W

Wide Area Network (WAN) ii, 60, 69

Wideband Test Access Panel 26

Wireless

DMS-100 Wireless offering **8-9**

Part of total service network ii

Service supported 37

Work-at-home (see also telecommuting)
ii, 23, 35, 38, 47

World Line Card (WLC) viii, x, **45**

X

X.25/X.75/X.75' 32, 63-64, 73

XA-Core iii, xii, *11*, **16-17**

xDSL iii, **46-47**

XPM (see also Peripheral Modules)

Defined 28

Faster loading with PRL **33**

With NTAX74AA 34-35

With XPM PLUS 29

XPM PLUS

Compared to NTAX74AA 34

Description **29**

With Black Box Fraud Prevention ix

With EDCH 29, **32**

With Extended Distance Capab. viii, **48**

With Peripheral/Remote Loader ix, **33**

Information subject to change since Northern Telecom reserves the right to make changes, without notice, in equipment design or components as engineering or manufacturing methods may warrant. Product capabilities and availability dates described in this document pertain solely to Northern Telecom's marketing activities in the United States and Canada. Availability in other markets may vary.

For more information, contact your Nortel representative or call 1-800-4 NORTEL (1-800-466-7835). Our Internet World Wide Web home page is at URL <http://www.nortel.com>

In U.S.:
Northern Telecom
P.O. Box 13010
Research Triangle Park, NC 27709

In Canada:
Northern Telecom
8200 Dixie Road, Suite 100
Brampton, Ontario L6T 5P6

50041.08/06-97 Issue 2
Printed in USA June 1997

NORTEL
NORTHERN TELECOM