

Critical Release Notice

Publication number: 297-2621-851
Publication release: Standard 15.01

Attention!

The UCS DMS-250 Data Schema Reference Manual, 297-2621-851, will continue to be updated and provided in the North America - DMS NTP collection.

The content of this customer NTP supports the SN09 (DMS) software release.

Bookmarks used in this NTP highlight the changes between the UCS15 baseline and the SN09 (DMS) release. The bookmarks provided are color-coded to identify release-specific content changes. NTP volumes that do not contain bookmarks indicate that the UCS15 baseline remains unchanged and is valid through the SN09 (DMS) release.

Bookmark Color Legend

Black: Applies to content for the UCS15 baseline that is valid through the current release.

Red: Applies to new or modified content for UCS17 that is valid through the current release.

Blue: Applies to new or modified content for UCS18 (SN05 DMS) that is valid through the current release.

Green: Applies to new or modified content for SN06 (DMS) that is valid through the current release.

Purple : Applies to new or modified content for SN07 (DMS) that is valid through the current release.

Pink: Applies to new or modified content for the SN08 (DMS) that is valid through the current release.

Orange: Applies to new or modified content for the SN09 (DMS) that is valid through the current release.

Attention!

Adobe ® Acrobat ® Reader ™ 5.0 or higher is required to view bookmarks in color.

Publication History

Note: Refer to the UCS15 baseline document for Publication History prior to the UCS17 software release.

November 2005

Standard NTP release 15.01 for the SN09 (DMS) software release.

Volume1

ANNMEMS (modified – A00009013)

ANNPHLST (modified – A00009013)

An additional documentation issue was made in October 2005 for the SN07 (DMS) software release. Refer to “Standard NTP release 13.02 for software release SN07 (DMS)”.

June 2005

Standard NTP release 14.02 for the SN08 (DMS) software release.

The following Data Schema content is updated for the SN08 (DMS) release. Content provided in this NTP is not superseded by content provided in the replacement NTP as indicated for the Preliminary release.

Volume1

AMAOPTS (new – A00007752)

Volume2

CDRTMPLT (modified – A00007752)

March 2005

Preliminary NTP release 14.01 for the SN08 (DMS) software release.

The following updated Data Schema content is provided in the Carrier VoIP Operational Configuration: Data Schema Reference NTP, NN10324-509. The content provided in NTP 297-2621-851 is superseded by the content provided in NTP NN10324-509.

ACDMISPL
CGBLDADD
CGBLDDGL
CGBLDDIG
CGBLDNI
CGBLDPI
CGPNBLDR
CUSTSTN_OPTION_DBO
EDAS

IBNLINES
ISERVOPT
KSETINV
TLDSIAMA_OPTS
TRKSGRP_TYPE_C7UP

The following new Data Schema content is provided in the Carrier VoIP Operational Configuration: Data Schema Reference NTP, NN10324-509. This content will not be provided in NTP 297-2621-851.

CGBLDSIN
LOGTHROT
NTPOLL

October 2005

Standard release 13.02 for software release SN07 (DMS). Updates made for this release are shown below.

Volume 1

BEARNETS (new – CR Q01083765)

Volume 2

DESDATA (new – CR Q01083765)

Volume 3

NET2NET (new – CR Q01083765)

NETBRIDGE (new – CR Q01083765)

NETPATH (new – CR Q01083765)

Volume 4

PRSUDATA (new – CR Q01083765)

SELDEFS (new – CR Q01083765)

SETDEFS (new – CR Q01083765)

December 2004

Standard release 13.01 for software release SN07 (DMS). Updates made for this release are shown below.

Volume 1

CAINPARAM - Added parameter STANDARD_ANISCREEN_RULES per CR Q00909834-01

CAINRESP - Added parameter AMABUSCUSTID per feature A00005363

CAINREXT - Added context identifier 300 to field AMA_DIGS_TYPE as per A00005363

Volume 2

CDRTMPLT - Added additional parameters to FIELD per feature A00005363

September 2004

Standard release 12.04. This release is current for the SN07 (DMS) software release,

although no changes have been made for SN07 (DMS) features.

Volume 1

CAINPARAM - Added parameter TRTMTCD_COMPCODE_ZAPPED_ZERO per CRQ00816405

Volume 5

TMTMAP (amended for CR Q00760514-10)

March 2004

Standard release 12.03 for software release SN06 (DMS)

Volume 3

LTDATA

Volume 4

SUSHELF

September 2003

Standard release 12.02 for software release SN06 (DMS). Updates made for this release are shown below.

Volume 1

CAINPARAM

Volume 2

DRMUSERS – this table is obsolete. The description has been removed.

DSLIMIT

IBNRTE selector CND

Volume 3

OFRT selector CND

Volume 4

STDPRTCT.STDPRT

Volume 5

TONES

June 2003

Preliminary release 12.01 for software release SN06 (DMS). Updates made for this release are shown below.

Volume 1

ACRTE

Volume 2

DNRTE

IBNRTE selector CND

Volume 3
OFRT selector CND

Volume 4
No changes

Volume 5
TRKOPTS, TRKSGRP

This page is intentionally blank.

297-2621-851

Digital Switching Systems

UCS DMS-250

Data Schema Reference Manual Volume 1 of 5

UCS15 Standard 09.02 June 2001

Digital Switching Systems

UCS DMS-250

Data Schema Reference Manual Volume 1 of 5

Publication number: 297-2621-851

Product release: UCS15

Document release: Standard 09.02

Date: June 2001

Copyright © 1998-2001 Nortel Networks,
All Rights Reserved

United States of America

NORTEL NETWORKS CONFIDENTIAL: The information contained herein is the property of Nortel Networks and is strictly confidential. Except as expressly authorized in writing by Nortel Networks, the holder shall keep all information contained herein confidential, shall disclose the information only to its employees with a need to know, and shall protect the information, in whole or in part, from disclosure and dissemination to third parties with the same degree of care it uses to protect its own confidential information, but with no less than reasonable care. Except as expressly authorized in writing by Nortel Networks, the holder is granted no rights to use the information contained herein.

Nortel Networks, the Nortel Networks logo, the Globemark, How the World Shares Ideas, and Unified Networks are trademarks of Nortel Networks.

Publication history

September 2000

Preliminary release 08.01 for software release UCS14(CSP14). This release includes a new table, BCHNLMEM, and incorporates changes to the following tables: CAINKEY, CAINMTCH, CAINPARM, CAINRESP, CAINREXT, CALLATTR, CDRTMPLT, CICROUTE, CUSTDP, NETBUSY, OCLDBUSY, OFFHKDEL, OFFHKIMM, OFTRREQ, OIECREO, ONOANSWR, OPCHOICE, PRIBCHNL, RTEATTR, SIOTRK, SPECDIG, SPECFEAT, TERMATT, TR533CIC, TRKGRPDAL, TRKGRPEANT, and TRKGRPPRA2.

August 2000

Standard release 07.02 for software release UCS13 (CSP13).

March 2000

Preliminary release 07.01 for software release UCS13 (CSP12). The following changes were made for this release:

This release incorporates changes to tables ANISCUSP, AUTHCODU, AUTHCODU2, AUTHCODU3, AUTHCODU4, AUTHCODU5, CAINPARM, CALLATTR, CDRTMPLT, CICROUTE, IN1RESP, LTCINV, NETSPROF, RTEATTR, STDPRTCT.STDPRT, TANDMRTE, TR533CIC, TRKGRP type DAL, TRKGRP type EANT, TRKGRP type IMT, TRKGRP type ONAL, TRKGRP type ONAT, TRKGRP type PRA2, UNIPROF. This release also includes new tables, LCAUDIT, SPNORTE, and AGCMAP. For more information about the changes, consult the table history at the end of each table.

February 2000

Standard release 06.02 for software release UCS12 (CSP12). The following changes were made for the Standard release 06.02 :

This release incorporates changes to tables CAINKEY, CAINMTCH, CAINPARM, CAINRESP, CAINREXT, CAINSRC, CAINXDFT, INWFPEAT, OFTRREQ, OIECREO, ANNS, CUSTDP, IN1RESP, NETBUSY, NETSPROF, CLDBUSY, OFFHKDEL, OFFHKIMM, ONOANSWR, PRIBCHNL, IOTRK, SPECDIG, SPECFEAT, TANDMRTE, TCAPANNC,

TERMATT, TOLLFREE, STDPRTCT.STDPRT, STDPRTCT, TRKGRP type DAL, TRKGRP type IMT. This release also includes a new Table, TR533CIC. For more information on the changes, consult the table history at the end of each table.

September 1999

Preliminary release 06.01 for software release UCS12 (CSP12).

This document replaces the *UCS DMS-250 Data Schema Reference Manual 297-231-851*.

This release incorporates changes to tables CDRTMPLT, TRKGRP type R2, and TRKGRP1.

May 1999

Standard release 03.02 for software release UCS11 (CSP11).

March 1999

Preliminary release 03.01 for software release UCS11 (CSP11).

This release includes changes to the following tables: CDRTMPLT, CAINPARG, CAINKEY, CAINMTCH, CAINRESP, CAINREXT, CAINXDFT, CAINMTCH, OFFHKIMM, OFTRREQ, OFFHKDEL, SOITRK, PRIBCHNL, SPECFEAT, CUSTDP, SPECDIG, NETBUSY, OCLDBUSY, ONOANSWR, OIECREO, TERMATT, TRKGRP, TRKGRP (IMT trunk group type), TRKGRP (DAL trunk group type), TRKGRP (EANT trunk group type), TRKGRP (ONAT trunk group type), TRKGRP (ONAL trunk group type), ANICUSP, OPCHOICE, AUTHCODU, AUTHCODU2, AUTHCODU3, AUTHCODU4, AUTHCODU5, CICROUTE, and UNIPROF.

November 1998

Standard release 02.02 for software release UCS09 (CSP09).

Contents

Publication history	iii
About this document	v
1 UCS data schema	1-1
How the data schema section is organized	1-1
ACCODE	1-7
ACGDUR	1-79
ACGGAP	1-82
ACGMAP	1-85
ACHEAD	1-89
ACRTE	1-222
ACSCRN2	1-241
ACTCTL	1-243
ACTPATCH	1-247
ACTSIG	1-249
ACTTRTMT	1-252
ADJNODE	1-255
AKEYTAB	1-259
ALARMTAB	1-263
ALMSC	1-266
ALMSCGRP	1-279
ALMSD	1-292
ALMSDGRP	1-301
AMAPARM	1-313
AMAOPTS	1-317
AMCODE	1-347
AMHEAD	1-411
ANISCRNU	1-495
ANISCUSP	1-497
ANIVAL	1-506
ANNMEMS	1-508
ANNS	1-514
APCDINV	1-521
APINV	1-525
AREACODE	1-529
ATTOPTNS	1-531
ATTSCHEd	1-537
AUDALARM	1-554

AUDIO	1-556
AUTHCODU	1-565
AUTHCDU2	1-574
AUTHCDU3	1-582
AUTHCDU4	1-590
AUTHCDU5	1-598
AUTHDIN	1-606
AUTOEXEC	1-609
AUTOHIB	1-612
AUTOTAB	1-614
BCCOMPAT	1-618
BBTKSGRP	1-624
BCDEF	1-627
BCHNLMEM	1-638
BLDDATA	1-641
C7AFTPC	1-644
C7ALIAS	1-651
C7ALWDPC	1-660
C7ALWGTT	1-669
C7ALWOPC	1-674
C7ALWSIO	1-684
C7BLKDPC	1-694
C7BLKOPC	1-705
C7BLKSIO	1-716
C7CDPA	1-723
C7CGPA	1-731
C7CNGSTN	1-742
C7DSTFLD	1-753
C7GATEPC	1-761
C7GATERS	1-763
C7GTT	1-765
C7GTTDF	1-769
C7GTTYPE	1-782
C7GTWLKS	1-785
C7ISL	1-803
C7LINK	1-804
C7LKPARAM	1-821
C7LKSET	1-826
C7LOCSSN	1-849
C7NETSSN	1-854
C7NETWRK	1-864
C7ROUTER	1-886
C7RPLSSN	1-888
C7RSSCRN	1-897
C7RTESET	1-901
C7TIMER	1-919
C7TRKMEM	1-968
C7UPTMR	1-972
CAINCONV	1-978
CAINGRP	1-981
CAINKEY	1-992

CAINMTCH	1-1001
CAINPARM	1-1017
CAINPRT	1-1062
CAINRESP	1-1068
CAINREXT	1-1105
CAINRSRC	1-1113
CAINSTS	1-1115
CAINUID	1-1117
CAINXDFT	1-1119
CALLATTR	1-1126

About this document

When to use this document

This publication contains detailed descriptions of the data schema tables in your DMS switch.

How to check the version and issue of this document

The version and issue of the document are indicated by numbers, for example, 01.01.

The first two digits indicate the version. The version number increases each time the document is updated to support a new software release. For example, the first release of a document is 01.01. In the next software release cycle, the first release of the same document is 02.01.

The second two digits indicate the issue. The issue number increases each time the document is revised but rereleased in the same software release cycle. For example, the second release of a document in the same software release cycle is 01.02.

To determine which version of this document applies to the software in your office and how documentation for your product is organized, check the release information in *Product Documentation Directory, 297-8991-001*.

References in this document

The following documents are referred to in this document:

- *Alarm System Description*, 297-1001-122
- *Basic Administration Procedures*, 297-1001-300
- *Basic Translations Tools Guide*, 297-1001-360
- *Device Independent Recording Package Administration Guide*, 297-1001-345
- *Disk Maintenance Reference Manual*, 297-1001-526
- *DMS-100 Provisioning Manual*, 297-1001-450
- *DMS SuperNode CCS7 Translations Guide*, 297-5151-350

- *DRAM and EDRAM Guide, 297-1001-527*
- *Input/Output system Reference Manual, 297-1001-129*
- *NORESTARTSWACT User Guide, 297-1001-546*
- *Peripheral Modules, 297-1001-103*
- *Programmable Service Node Application Guide, 297-2621-380*
- *Service Problem Analysis Administration Guide, 297-1001-318*
- *Switch Performance Monitoring System Application Guide, 297-1001-330*
- *Trunks Maintenance Guide, 297-1001-595*
- *UCS DMS-250 Billing Records Application Guide, 297-2621-395*
- *UCS DMS-250 Logs Reference Manual, 297-2621-840*
- *UCS DMS-250 FlexDial Framework Application Guide, 297-2621-390*
- *UCS DMS-250 NetworkBuilder Application Guide, 297-2621-370*
- *UCS DMS-250 Operational Measurements Reference Manual, 297-2621-814*
- *UCS DMS-250 Office Parameters Reference Manual, 297-2621-855*
- *Software Optionality Control (SOC) User's manual, 297-2621-301*

What precautionary messages mean

The types of precautionary messages used in NT documents include attention boxes and danger, warning, and caution messages.

An attention box identifies information that is necessary for the proper performance of a procedure or task or the correct interpretation of information or data. Danger, warning, and caution messages indicate possible risks.

Examples of the precautionary messages follow.

ATTENTION - Information needed to perform a task

ATTENTION

If the unused DS-3 ports are not deprovisioned before a DS-1/VT Mapper is installed, the DS-1 traffic will not be carried through the DS-1/VT Mapper, even though the DS-1/VT Mapper is properly provisioned.

DANGER - Possibility of personal injury

**DANGER****Risk of electrocution**

Do not open the front panel of the inverter unless fuses F1, F2, and F3 have been removed. The inverter contains high-voltage lines. Until the fuses are removed, the high-voltage lines are active, and you risk being electrocuted.

WARNING - Possibility of equipment damage

**WARNING****Damage to the backplane connector pins**

Align the card before seating it, to avoid bending the backplane connector pins. Use light thumb pressure to align the card with the connectors. Next, use the levers on the card to seat the card into the connectors.

CAUTION - Possibility of service interruption or degradation

**CAUTION****Possible loss of service**

Before continuing, confirm that you are removing the card from the inactive unit of the peripheral module. Subscriber service will be lost if you remove a card from the active unit.

How commands, parameters, and responses are represented

Commands, parameters, and responses in this document conform to the following conventions.

Input prompt (>)

An input prompt (>) indicates that the information that follows is a command:

>BSY

Commands and fixed parameters

Commands and fixed parameters that are entered at a MAP terminal are shown in uppercase letters:

```
>BSY CTRL
```

Variables

Variables are shown in lowercase letters:

```
>BSY CTRL ctrl_no
```

The letters or numbers that the variable represents must be entered. Each variable is explained in a list that follows the command string.

Responses

Responses correspond to the MAP display and are shown in a different type:

```
FP 3 Busy CTRL 0: Command request has been submitted.
```

```
FP 3 Busy CTRL 0: Command passed.
```

1 UCS data schema

How the data schema section is organized

Data schema tables are arranged in alphabetical order by short table name. Each table has a unique name, which is the abbreviation of the long table title. For example, table CLLI is the short table name for the Common Language Location Identifier Table.

Subtables appear after their head table. A subtable is a further refinement of a table and can be identified by a table name, followed by a period (.), followed by another table name. For example, CLLIMITCE.DIAGDATA, where CLLIMITCE is the head table and DIAGDATA is the subtable.

Note: Tables OFCENG, OFCOPT, OFCSTD, and OFCVAR are in the *Office Parameters Reference Manual*.

A list of all data schema tables is contained in the chapter "Master list of data schema tables."

Data schema overview

The purpose of data schema is to assist the operating company in preparing office-dependent data for the relevant DMS switching unit.

The office-dependent data is stored in a series of data store lookup tables that are used in conjunction with software programs and circuits to advance each call through the various stages of call processing.

The data schema portion of the document provides functional descriptions of tables and their fields, including valid entries for each field. It does not provide translation information, call progression sequence, or complete feature implementation datafill.

Data schema is divided into modules, with each module describing one table. As new software features are added, or capabilities are enhanced, existing table documents are revised, or new tables are written.

As of BCS35, data schema documentation contains information formerly contained in the publications shown in the following table.

Table 1-1 BCS35 Consolidated data schema publications

Number	Name
297-2001-451	<i>DMS-100 Meridian Customer Data Schema</i>
297-2101-451	<i>DMS-100 Local Customer Data Schema</i>
297-2201-451	<i>DMS-200 Toll Customer Data Schema</i>

As of BCS36, data schema documentation contains information formerly contained in the publications shown in the following table.

Table 1-2 BCS36 Consolidated data schema publications

Number	Name
297-2001-451	<i>DMS-100 Meridian Digital Centrex (MDC) Customer Data Schema</i>
297-2101-451	<i>DMS-100 Local Customer Data Schema</i>
297-2181-451	<i>DMS-100 International Customer Data Schema</i>
297-2201-451	<i>DMS-200 Toll Customer Data Schema</i>
297-2301-451	<i>DMS-300 Gateway Customer Data Schema</i>

After BCS36, the consolidated data schema documentation (297-1001-451) was cancelled. The information in it was modified to correspond to product computing module loads (PCL) based on specific markets and included as part of the *Translations Guide*. Each PCL has its own *Translations Guide* differentiated by a unique NTP layer number (297-yyyy-350) which contains market-specific translations features and data schema documents. For example the *Translations Guide* for PCL LETB004 is identified by NTP

297-8021-350 and contains U.S. DMS-100/DMS-200 and TOPS combination switch translations features and data schema documents.

Table descriptions

Table descriptions are arranged alphabetically according to short table name.

Data schema tables are described under the following headings:

Table name

This section gives the full table name from which the short table name printed on the page header is derived.

Overview

This optional section gives an overview of the system that the table controls.

Functional description

This section describes how the table is accessed and used by the system, as well as its relation with other tables, feature packages, and features. If appropriate, a description of how to add, delete, or change tuples in the table is included. For some tables, flow charts and block diagrams are used to help illustrate the functional description.

Datafill sequence and implications

This section lists other tables that must be datafilled before or after the table being datafilled, as well as office parameters that interact with the table. If appropriate, any implication involving the datafill sequence is included.

Table size

This section gives the minimum and maximum number of tuples allowed in the table. If appropriate, information on memory allocation is also included. For more complicated tables, a formula for calculating the table size is included.

Field descriptions

Descriptions of the fields in the table are presented in table format. The first column is the short field name as it appears on the MAP terminal. The second column is the short subfield name as it appears on the MAP terminal. The third column gives the range of possible entries in the field. The fourth column gives the expanded field name and a description of the entries, including any default values.

If the short field name is followed by a dash (-) and a BCS number, the field is valid for all software releases up to and including the BCS indicated. If the short field name is followed by a BCS number and a dash (-), the field appeared for the first time in the release indicated and is still applicable. For example,

TABINDX (-BCS35) is valid up to and including BCS35. TABINDX (BCS36-) is valid for BCS36 and up. See the following table.

Table 1-3 Field descriptions

Field	Subfield or refinement	Entry	Explanation and action
TABINDX (-BCS35)		numeric (2 to 4 digits)	<i>Table index</i> Enter the index into the table.
TABINDX (BCS36-)		numeric (2 to 4 digits)	<i>Table index</i> Enter the index into the table.

The use of a dash to indicate software release dates is not supported in the PCL environment.

Terms used in the “Field descriptions” section are explained below.

- *Entry* An entry is an alphanumeric combination of characters for a field, a subfield, a refinement, or a vector. Entries are datafilled by Northern Telecom, by the operating company, or by the DMS system. Entire tables that the operating company can access but cannot change are read-only or NT-only tables. Such tables are rarely documented.
- *Field* A field is one column of a table. Each field has a name that describes the content of the field. For example, a field that contains directory numbers can be named field DN.
- *Key field* A key field is found in each table. Tables can have more than one key field. These fields uniquely identify any tuple in the table. Knowing the key fields of a table is important if using the table editor.
- *Range* The range of a field is the set of all possible data values that can be entered in the field. For example, a field called NUMBER can have a range of 1 to 20. RANGE is also a table editor command that can be entered at the MAP terminal to determine the range of a field, subfield, or refinement. The range is shown between curly brackets, { }. When a description of the range is shown instead of curly brackets, the datafill is a variable that depends on other datafill or is an alphanumeric entry to be chosen by the operating company. In the explanation of a range, the phrase “entries outside of the indicated range are invalid” means that values shown at the MAP terminal that are not described in the NTP are not to be used.
- *Subfield* A subfield is a division of a field. For example, the field named LEN most often consists of subfields SITE, FRAME, UNIT, DRAWER, and CIRCUIT.
- *Refinement* A refinement is a field that further modifies the field preceding it, depending on the datafill in the first field. For example, if the entry in

field `OPTION` in table `SCAILNKS` is `BOCTIME`, refinement `TIME` must be datafilled. If the entry is `SCAIRTE`, refinement `TABNAME` must be datafilled.

- *Table editor* The table editor is the user interface to the data schema database. It allows the user to view tables, add or delete tuples, and change data in tuples.
- *Tuple* A tuple is one row of data in a table. A row can be one field or a combination of fields up to all fields in the table. When adding or changing at least one entry of a tuple using table editor commands at a MAP terminal, confirmation of the new tuple is prompted.
- *Value* A value is synonymous with an entry.
- *Vector* A vector is a field that can contain more than one entry. Each entry is separated by a single space. If less than the maximum number of allowed entries is required, the list is ended with a \$ (dollar sign). For example, field `OPTCARD` in table `LTCINV` can contain up to ten optional cards. Each entry is separated by a single space and if less than ten optional cards are required, the list is ended with a \$ (dollar sign).

Datafill example

This section shows an example of a MAP display of the datafilled table, using the following format.

SSNAME	PROTCLID	FKEY
OM	3	F15
AMA	1	F13

Where appropriate, explanations are provided for the specific datafill in the example.

Table history

This section lists the BCS or the PCL in which the table changed, with a short description of the change. After BCS36, a BCS software load is referred to as a product computing module load (PCL) identifier.

When a table becomes obsolete, the PCL or software layer is identified. The table document is removed from the NTP during subsequent releases.

Supplementary information

This section contains information that is pertinent to the data schema table but does not logically belong under previous sections. For example, error messages prior to BCS36, or dump and restore procedures are often found here.

Table descriptions for line equipment number (LEN) fields

Because field LEN is common to more than 60 tables, it is documented in a single section to avoid duplication. Each time field LEN occurs in a table, the field description refers to section "Common entry field LEN" for a complete description of field LEN and associated subfields.

Restructured tables

Occasionally a table undergoes major restructure from one BCS or PCL to another. In this case, the BCS markers described under the section "Field descriptions" above are included following the long table name and the short table name.

For example, in BCS36, table IPNETWORK was restructured to the extent that all field names were changed. The table description for BCS36 and up is included in the table description IPNETWORK (BCS36-) while the table description up to and including BCS35 is included in the table description IPNETWORK (-BCS35).

The old version of the table description precedes the new table description in the data schema section of this document.

Cross-reference tables

The following cross-reference tables are provided in the introductory chapters of the data schema section of this document:

- Table completion responsibility
- Master list of data schema tables

ACCODE

Table name

Access Code Table

Functional description

The following table lists all of the "CODE" tables. Throughout this document, "xxCODE" represents one of the CODE tables.

Universal translation tables

Table name	Form title
ACCODE	Access Code Table Record
AMCODE	Ambiguous Code Table Record
CTCODE	Country Code Table Record
FACODE	Foreign Area Code Table Record
FTCODE	Utility Code Table Record
NSCCODE	Number Service Code Table Record
OFCCODE	Office Code Table Record
PXCODE	Prefix Code Table Record

Each xxCODE table has a corresponding xxHEAD table and xxRTE table. (There is no table AMRTE.) Each type of table is datafilled identically.

The starting point for translations is the xxCODE table given in the trunk data or table NETATTR, using the translation selector UNIV followed by the appropriate translation system and table name. Before the table name can be datafilled, it must be defined in the xxHEAD table of the appropriate translation system. The path through the translation tables is given exclusively by option XLT. Option XLT is specified in selectors CONT or DMOD in the xxCODE table, and in selectors DFOP or DFLT of the xxHEAD table.

In general, if the same option is found in two different tuples during a pass through translations, the value in the last tuple is used. For example, if field CLASS is set to LCL in table PXCODE, it can be reset to NATL in table FACODE.

For related information, refer to table ACHEAD.

ACCODE (continued)

Datavill sequence and implications

The following tables must be datavilled before table xxCODE:

- xxHEAD
- MDESTIDX (only for the Advice of Charge feature)
- SERVPROF
- BCDEF
- NSCDEFS (if translation selector DBQ is used)
- TRKSGRP (if optional selector CGNDM for translation selector DMOD is used)
- LNETWORK (only for the Advice of Charge feature)
- CDNCHAR
- CLISERV

Only automatic number identification (type ANI) and international metering (type MTR) trunk group originations support the option selector CAMA. All other call types ignore this translation option.

For emergency calls translation, class EMRG must be datavilled. This can be done before or after translation selector CONT with option selector CLASS. This requirement differentiates between normal mobile originated calls and emergency calls set up by a conventional SETUP message.

Optional selector CGNDM can be used with translation selector DMOD if the switch is equipped with module IXLACLI and the default Calling Line Identification (CLI) is datavilled in table TRKSGRP. Different default CLIs can be datavilled on requirements. Optional selector CGNDM must also be datavilled in table ACCODE to activate the feature.

The following office parameters affect table xxCODE:

- ICAMA_REQUESTED in table OFCVAR
- IAA_REQUESTED in table OFCVAR
- IMEI_ACCEPTABLE_FOR_EMRG_CALL in table OFCVAR

For option selector CAMA (used in translation selectors CONT, DNRTE, and RTE), set office parameter ICAMA_REQUESTED in table OFCVAR to Y (yes) if international centralized automatic message accounting (ICAMA) detailed call recording is required.

ACCODE (continued)

An inter-administration accounting (IAA) record can be generated by selecting office parameter IAA_REQUESTED in table OFCVAR, and selector CAMA.

Office parameter IMEI_ACCEPTABLE_FOR_EMERG_CALL in table OFCVAR provides an option for the network operator to accept emergency call setups from mobile stations that transmit the international mobile equipment identity (IMEI) instead of the international mobile subscriber identity (IMSI) or temporary mobile subscriber identity (TMSI). The default value allows emergency call setups with IMEI as the identifier if, for example, no serial interface module (SIM) is present.

Table size

There is no fixed maximum number of tuples in each table, but the maximum total number of tuples is 32 768. The number of tuples is allocated dynamically. Memory is allocated when field XLANAME is datafilled in the xxHEAD table.

Note 1: The maximum number of tuples may vary due to compression and expansion of tuples.

Note 2: Depending on the range of “from digits” and “to digits” within each tuple, the table can run out of room before the maximum of 32 768 tuples is reached. This is due to the number of digilator blocks used by all the tuples in the table.

Note 3: The DMSMON DBLOCKS tool can be used to monitor the size of this table.

Tuple compression

Starting in release TL006, the CONSUME option is always datafilled. If it is not datafilled by the operating company personnel, the universal translation (UXLA) system's write procedure automatically adds the datafill and sets it to the original key length. This action is taken for the following reasons:

- The UXLA system only has access to the key length in the write procedure for table xxCODE. It is done at this time so the key length is available if required during call processing.
- If tuple compression or expansion changes the key length, the consume value cannot be updated to reflect these changes. The result is that translations consume the original key length, not the current key length, during call processing. CONSUME is forced to be datafilled to make the operating company personnel aware of the number of digits that are consumed. Therefore, the default option (DFOP) CONSUME is not used.

ACCODE (continued)

When a tuple is initially added to table xxCODE, the key length is stored. If the tuple is then split, the new tuple's length is stored for that tuple. At this point, there are three tuples, two of one length, and a third of a different length. If the tuple that is now out of the first range of digits is changed to the original value, it will not compress because the original length of the three tuples is different. See the following examples. (The consume option is not on for any of the tuples in these examples.) The entry "exp_tuple" represents the XLANAME table entry. Original tuple: add exp_tuple 0181 0181 feat... The tuple is split: rep exp_tuple 01818100181810 dnrte... Resulting tuples:

```
exp_tuple 0181 0181809 feat...    (hidden consume = 4)
```

```
exp_tuple 0181810 0181810 dnrte... (hidden consume = 7)
```

```
exp_tuple 0181811 0181811 feat...  (hidden consume = 4)
```

If the middle tuple is changed back to the original value the result is as follows: rep exp_tuple 0181810 0181810

Resulting tuples:

```
exp_tuple 0181 0181809 feat...    (hidden consume = 4)
```

```
exp_tuple 081810 0181810 feat... (hidden consume = 7)
```

```
exp_tuple 0181811 0181 feat...    (hidden consume = 4)
```

The tuples did not compress because the tuples must be identical in content and key length. To compress the tuple see the following:

Enter:

```
rep exp_tuple 0181000 018809 feat...
```

```
rep exp_tuple 0181811 0181999 feat...
```

Resulting tuple:

```
exp_tuple 0181 0181 feat...
```

If a tuple is added, for example:

```
add exp_tuple 0182 0182 feat...
```

Resulting tuples:

ACCODE (continued)

exp_tuple 0181 0181 feat... (hidden consume = 7)

exp_tuple 0182 0182 feat... (hidden consume = 4)

To compress these tuples

Enter:

rep exp_tuple 0182000 0182999 feat...

Resulting tuple:

exp_tuple 0181 0182 feat... (hidden consume = 7)

Datafill

The following table lists datafill for table ACCODE and other xxCODE tables.

Field descriptions (Sheet 1 of 3)

Field	Subfield	Entry	Explanation and action
XLANAME		alphanumeric (1 to 8 characters)	Translation name. Enter the name from the corresponding head table.
FROMD		numeric (1 to 11 digits)	From digit. Enter the digit or digits that represent a single number or the first in a block of consecutive numbers that have the same result given in field XLADATA. See the following notes.
TOD		numeric (1 to 11 digits)	To digits. If field FROMD represents a single number, enter the number that is equal to the number in field FROMD. If field FROMD represents the first number of a block of consecutive numbers, enter the last number in the block. See notes below.

ACCODE (continued)

Field descriptions (Sheet 2 of 3)

Field	Subfield	Entry	Explanation and action
<p>Note 1: Adding or changing a tuple affects all digit combinations between fields FROMD and TOD; however, command DELETE only deletes the tuple at field FROMD.</p> <p>Note 2: Because of the way the FROM and TO digit key is implemented, the operation of table control requires additional explanation. For example, a tuple is datafilled with the value in field TOD greater than the value in field FROMD (field FROMD is set to 3 and field TOD is set to 8). If a user positions on a tuple with fields FROMD and TOD within the datafilled range, the tuple is displayed as if only those digits are datafilled as the key.</p> <p>In this example, the user positions on the tuple with fields FROMD and TOD both equal to 5. The tuple is displayed with both fields equal to 5. The information is being requested for the given key. If the user then displays the previous tuple, fields FROMD and TOD contain the digits originally datafilled before the current FROMD digit. In this example, the FROMD and TOD digits are 3 and 8. If the user now displays the next tuple, the digits following the currently displayed TOD field are displayed, 5 and 8.</p>			
XLADATA		see subfield	Universal translations data. This field consists of subfield XLASEL. Subfield XLASEL and its refinements are described following the description of field CONTMARK.
CONTMARK		+ or \$	Continuation mark. Enter + if additional information for this tuple is contained in the next record. Otherwise, enter \$ to indicate the end of the tuple.
	XLASEL	CONT, DBQ, DMOD, DNRTE, FEAT, FEATINFO, HRC, IAC, RTE, or TRMT	<p>Translation selector. Enter one of the following values:</p> <p>Enter CONT and datafill its refinements if further translation is required.</p> <p>Enter DBQ and datafill its refinements to perform a database query.</p> <p>Enter DMOD and datafill its refinements if the input digit stream requires modification.</p> <p>Enter DNRTE and datafill its refinements if the input digits are routed—normally to a line.</p> <p>Enter FEAT and datafill its refinements if access to a feature is required.</p>

ACCODE (continued)**Field descriptions (Sheet 3 of 3)**

Field	Subfield	Entry	Explanation and action
			<p>Enter FEATINFO and datafill its refinements to trigger the screening function.</p> <p>Enter HRC and datafill its refinements if the home routing code selector is required for local number portability applications.</p> <p>Enter IAC and datafill its refinements if the insertion of own area code is required when an ambiguous area code is found through translations.</p> <p>Enter RTE and datafill its refinements if the call is routed to a trunk.</p> <p>Enter TRMT and datafill its refinements if a call is routed to treatment.</p>

XLASEL = CONT

If the entry in field XLASEL is CONT, datafill the following refinements.

This selector is used if more translation is required. The next table to use is given by option XLT. Option CON in the xxHEAD table entry for the current XLANAME determines whether the digits that were used to index the current table are to be consumed (that is, ignored by the next table). For example, in a pretranslator, the digits are not usually consumed, but they are consumed when continuing from the office code table (OFCCODE) to table DNINV. The consumed digits are not deleted from the digit register; they are ignored for the moment.

Note: If translation continues and no next translation table is specified (with option XLT), UXLA reenters the same table it is currently in. If option CON is set in the xxHEAD table, a new translation results because different digits are used. If a next translation table is not specified and option NOCON is set, UXLA reenters the same table with the same digits, gets the same result, and continues looping through the table.

It is possible to datafill the tables so that the same table is explicitly reentered, but it is not recommended because it makes the sequence very difficult to follow and prone to error. (The same table refers to the same table in the same translation system. It is correct to enter a different table in the same translation system if option XLT is used.) If the same table is entered, it is datafilled explicitly.

ACCODE (continued)

If selector CONT is used, option XLT must be datafilled in the xxCODE table tuple or in the default options (DFOP) of the corresponding xxHEAD table. If selector CONT is used in the default tuple (DFLT), option XLT must be datafilled. The selector DMOD does not use the default options from the xxHEAD table, so option XLT must also be datafilled in the xxCODE table tuple.

Table AMAXLAID must be datafilled prior to selecting option AMAXLAID.

If options CDNRTE and CPCRTE are both present in one tuple in table xxCODE, call processing accesses routing tables in the following order: table CPCUXLA is accessed first. If no match is found, table CDNUXLA is accessed next.

ACCODE (continued)

If options SETCDN and CDNRTE are both present in one tuple in table xxCODE, call processing accesses table CDNUXLA first, before the SETCDN option sets the called number name (CDNNAME).

ACCODE (continued)**Field descriptions for conditional datafill (Sheet 1 of 15)**

Field	Subfield	Entry	Explanation and action
	OPT	see subfield	Options. This field is a vector consisting of up to ten options. Each option consists of subfield OSEL and refinements that depend on the entry in subfield OSEL. For each option, specify the option selector (OSEL), followed by a space, and the refinements, each separated by a space. The entry is concluded by a \$. Datafill continues with field DFOP.
	OSEL	ACF, AMAXLAID, CALLCTRL, CALLDUR CAMA, CATRTE, CDN, CDNRTE, CHGIND, CLASS, CLIOVRD, CONSUME, CPCRTE, CPMCALL, DDIDX, DEST, DFT, EXTCIC, IAA, LNET, MM, MZONE, NETSRV, NICRF, NOANSTIM, OSS, PCC, PF, PNRF, PORTED, PRESEL, PRIVL, QFT, SETCDN, TELETAXE, TOC, VPN, or XLT	<p>Option selector. The following options can be selected:</p> <p>Enter ACF, followed by a space, and datafill refinement ACF if the area code fence is defined.</p> <p>Enter AMAXLAID, followed by a space, and datafill refinement XLAID to specify an automatic message accounting (AMA) identity from within table AMAXLAID.</p> <p>Enter CALLCTRL, followed by a space, and datafill refinement CALLCTRL. The entry in refinement CALLCTRL indicates who has control of the call: the calling party, the called party, or both.</p> <p>Enter CALLDUR, followed by a space, and datafill requirement CALL_DURATION_TIMER. The entry in refinement CALL_DURATION_TIMER defines the call time limit for Premium Rate Service calls.</p> <p>Enter CAMA, followed by a space, and datafill refinement CLDFMT. The entry in field CLDFMT indicates whether the international centralized automatic message accounting (ICAMA) record is generated with the the originally signaled directory number (DN) or the final public switched telephone network (PSTN) number.</p> <p>Enter CATRTE to allow charge category routing in IBN translations.</p>

ACCODE (continued)

Field descriptions for conditional datafill (Sheet 2 of 15)

Field	Subfield	Entry	Explanation and action
			<p>Enter CDN, followed by a space, and datafill refinement CDN to select the nature of address field. This field is used to identify the called party of the initial address message (IAM). This selector is used for Australian ISDN user part (AISUP) call translations.</p> <p>Enter CDN RTE to route using the called number name (CDNNAME) from table CDNCHAR. If the CDNNAME is present on the incoming call or is set by the SETCDN option, translation proceeds to table CDNUXLA.</p> <p>Enter CHGIND, followed by a space, and enter refinement CHGIND.</p> <p>Enter CLASS, followed by a space, and datafill refinement CLASS if the class of the dialed digits can be determined.</p> <p>Note: For the Japan market, if both the CLASS and IAA options are in use, IAA must precede CLASS in the datafill order.</p> <p>Enter CLIOVRD, followed by a space, and datafill refinement CLIOVRD to block or allow per-call delivery of a calling line identity (CLI). The entry in refinement CLIOVRD indicates whether the CLI can be blocked per-call, CNB (calling number blocked), or CNA (calling number allowed).</p> <p>Enter CONSUME, followed by a space, and datafill refinement CONDIGS to specify the number of digits that are consumed during translation.</p> <p>Enter CPC RTE to route using the calling party category (CPCNAME) from table CPCCHAR. If the CPCNAME is present on the incoming call, translation proceeds to table CPCUXLA.</p>

ACCODE (continued)

Field descriptions for conditional datafill (Sheet 3 of 15)

Field	Subfield	Entry	Explanation and action
			<p>Enter CPMCALL, followed by a space, and datafill refinement CPMCALL to specify call billing against the called party instead of the calling party for intra-office calls.</p>
			<p>Enter DDIDX, followed by a space, and datafill refinement DDIDX if a destination discount applies.</p>
			<p>Enter DEST, followed by a space, and datafill refinement DEST if the destination is known.</p>
			<p>Enter DFT for DPNSS feature transparency functionality. Operates in conjunction with the QFT option (see later). QFT must be ON.</p>
			<p>Enter EXTCIC, followed by a space, and datafill refinements SOURCE, SKIPDIGS, and CICSIZE. EXTCIC is the external carrier identification code that indicates a long distance carrier in the global environment. This option is only supported for TOPS calls. For further information, refer to functionality Global Competitive Access, GOS00006.</p>
			<p>Enter IAA and the datafill refinement IAA_INDEX to generate or modify IAA message parameters based on datafill in table IAACtrl.</p>
			<p>Note: For the Japan market, if both the IAA and CLASS options are in use, IAA must precede CLASS in the datafill order.</p>

ACCODE (continued)

Field descriptions for conditional datafill (Sheet 4 of 15)

Field	Subfield	Entry	Explanation and action
			<p>Enter LNET, followed by a space, and datafill refinement LNET if a logical network is required for metering.</p> <p>Enter MM, followed by a space, and datafill refinements MIN and MAX if the minimum and maximum dialed digits are known.</p> <p>Note: The Attendant Console does not abide by normal digit collection timers. When the max digits in translations have not been dialed, a ten second post dial delay (PDD) occurs. Long and short timers are ignored.</p> <p>Enter MZONE, followed by a space, and datafill refinement MZONE if metering is to be done on the call.</p> <p>Enter NETSRV and datafill refinement NETSRV_NAME to indicate a Japan network service.</p> <p>Enter NICRF to activate the Network Identification Code (NIC) routing function.</p> <p>Enter NOANSTIM to the CONT selectors. This turns the T9 timer off in the outgoing ISUP trunk, if encountered.</p> <p>Enter OSS to indicate Operator Services Signaling is necessary. The OSS option does not have subfields.</p> <p>Enter PCC, followed by a space, and datafill refinement PCCDR if a pseudo country code is required.</p> <p>Enter PF, followed by a space, and datafill refinement PFDIGS if there are prefix digits in the digit stream.</p> <p>Enter PNRF to invoke the ported number recognition function.</p> <p>Enter PORTED to indicate that a previous node detected the service number of this call to have been ported.</p>

ACCODE (continued)

Field descriptions for conditional datafill (Sheet 5 of 15)

Field	Subfield	Entry	Explanation and action
			<p>Enter PRESEL, followed by a space, if the call is to be treated as a preselected carrier case.</p> <p>Enter PRIVL, followed by a space, and datafill refinement PRIVL if the user is a privileged user (for example, operators).</p> <p>Enter QFT followed by ON or OFF to indicate if an outgoing route is capable of QSIG Feature Transparency.</p> <p>Note: The QFT ON option must not be added to a route unless the far-end node is QFT-capable.</p> <p>Enter SETCDN to trigger the setting of outgoing called party characteristics. This option assigns the called number name (CDNNAME) from table CDNCHAR to the call. If the CDNRTE option is subsequently encountered, the CDNNAME is used to route the call.</p> <p>You can use the SETCDN option to allow CDN routing when incoming agents such as DPNSS or BTUP are not available in table CDNCHAR.</p> <p>Enter TELETAXE. The TELETAXE option does not have subfields.</p> <p>Enter TOC, followed by a space, and datafill refinement CHG for the type of charge if the type of charge messaging is selected.</p> <p>Enter VPN, followed by a space, and datafill refinements ONNET and BILLABLE if the call routes through a service switching point (SSP) and the Australian VPN SSP feature is in the switching unit.</p> <p>Enter XLT, followed by a space, and datafill refinement XLASYS if the call is to proceed to another translation system.</p>

ACCODE (continued)**Field descriptions for conditional datafill (Sheet 6 of 15)**

Field	Subfield	Entry	Explanation and action
	ACF	0 to 29	Area code fence. If the entry in subfield OSEL is ACF, datafill this refinement. Enter the number of digits between the beginning of the digits to currently index the table, and the end of the area code.
	BILLABLE	Y or N	Virtual private network billable call. If the entry in subfield OSEL is VPN, datafill this refinement. Enter Y if an AMA record is required for each VPN call. Otherwise, enter N. An AMA record is not generated if an address complete message (ACM) of address complete—no charge is returned, or if the call terminates in the SSP on a line with the free number terminating (FNT) option.
	CALLCLASS	PRESELECT OVERRIDE, CALLTYPE, CSN,TRUNK	Call class. If the entry in subfield OSEL is PRESEL, enter PRESELECT to treat the DN as a preselected call. Enter OVERRIDE to permit the DN to use override codes. For charge category routing, enter CALLTYPE. Enter CSN to treat the DN as a carrier specific number. Enter TRUNK to permit access to trunk originated calls.

ACCODE (continued)**Field descriptions for conditional datafill (Sheet 7 of 15)**

Field	Subfield	Entry	Explanation and action
	CALLCTRL	CALLED, CALLING, LAST, or MUTUAL	<p>Call control. If the entry in subfield OSEL is CALLCTRL, datafill this refinement. Enter one of the following values to specify the party controlling the call:</p> <ul style="list-style-type: none"> If the entry is CALLED and the called party goes on-hook first, the call is released immediately. If the calling line goes on-hook first and does not reanswer, the connection is not released until the called line goes on-hook. There are no time-outs, and the calling party is allowed to reanswer until the called line goes on-hook. <p>Calls to lines with option ESG must have CALLCTRL(CALLED).</p> <p>Calls terminating on an International Traffic Operator Position System (ITOPS) must have CALLCTRL (CALLED).</p> <ul style="list-style-type: none"> If the entry is CALLING and the calling line goes on-hook first, the call is released immediately. If the called line goes on-hook first, the called party is allowed to reanswer within a datafilled reanswer time-out or until the calling line goes on-hook. If the time-out expires or if the calling line goes on-hook, the calling party releases the call and the called party is set to idle. <p>Call control (continued). Enter one of the following values to specify the party controlling the call:</p> <ul style="list-style-type: none"> If the entry is LAST, the call is released when the later of the called party or the calling party goes on-hook. If either party goes on-hook, that party is allowed to reanswer within a datafilled reanswer time-out or until both parties go on-hook. If the entry is MUTUAL and either line goes on-hook, the call is released immediately.

ACCODE (continued)**Field descriptions for conditional datafill (Sheet 8 of 15)**

Field	Subfield	Entry	Explanation and action
	CATRTE	CATRTE	Enter CATRTE to allow charge category routing in IBN translations.
	CDNNAME	alphanumeric string	If the entry in subfield OSEL is SETCDN, enter data for the CDNNAME refinement to allow CDN routing.
	CHG	SEND_CHARGE or SEND_NO_CHARGE	Charge. If the entry in subfield OSEL is TOC, datafill this refinement. Enter SEND_CHARGE to set the answer message (BTUP ANM) type of answer (TOA) string sent from a node to SEND_CHARGE. Enter SEND_NO_CHARGE to set the answer message (BTUP ANM) type of answer (TOA) string sent from a node to SEND_NO_CHARGE.
	CHGIND	ASIS, CHG, or NOCHG	If the entry in subfield OSEL is CHGIND, enter data for refinement CHGIND. The CHGIND refinement indicates whether to override the value of the charge indicator in the Backward Call indicators. Datafill the CHGIND field with the following values: <ul style="list-style-type: none"> • ASIS—treat charge indicator as is • CHG—treat charge indicator as charge • NOCHG—treat charge indicator as no charge
	CICSIZE	1 to 4	CIC size. If the entry in subfield OSEL is EXTCIC, datafill this refinement. This field indicates the number of digits in the CIC. This field operates on the B (called) number, so it is assumed that the CIC is signaled as part of the B number. The MAP display indicates the range is 0 to 4; however, the system does not allow 0.

ACCODE (continued)**Field descriptions for conditional datafill (Sheet 9 of 15)**

Field	Subfield	Entry	Explanation and action
	CLDFMT	CURRENT or POSTXLA	<p>Called format. If the entry in subfield OSEL is CAMA, enter either CURRENT or POSTXLA to produce the required ICAMA record format.</p> <p>If the entry is CURRENT, an ICAMA record is produced with the signaled DN (without translation).</p> <p>If the entry is POSTXLA, an ICAMA record is produced with a public switched telephone network (PSTN) number resulting from translations.</p>
	CLASS	ATT, CNTL, COLL, DATT, EMRG, IAGRP, ICNTL, INTL, IOPRA, LCL, NATL, OPRA, RURAL, SPEC, UNKW, or URBAN	<p>Translation CLASS. If the entry in subfield OSEL is CLASS, datafill this refinement. Enter the translation class determined by the dialed digits, as listed below. (This can be used for screening or billing purposes as described under CLASS in screening and charging options.)</p> <ul style="list-style-type: none"> • ATT (attendant console) • CNTL (continental) • COLL (collect) • DATT (dial attendant) • EMRG (emergency) • IAGRP (interagent group) • ICNTL (intercontinental) • INTL (international) • IOPRA (international operator assisted) • LCL (local) • NATL (national) • OPRA (operator assisted) • RURAL (rural) • SPEC (special) • UNKW (unknown) • URBAN (urban)

ACCODE (continued)**Field descriptions for conditional datafill (Sheet 10 of 15)**

Field	Subfield	Entry	Explanation and action
	CLIOVRD	CNA, CNB	If the entry in subfield OSEL is CLIOVRD, enter data for the CLIOVRD refinement to block or allow delivery of a calling line identity for each call. Enter CNA (calling number allowed) or CNB (calling number blocked).
	CONDIGS	0 to 29 digits	Consumed digits. If the entry in subfield OSEL is CONSUME, datafill this refinement. Enter a number to explicitly define the number of digits consumed during call processing.
	CONTINUE	CONT or NOCONT	Continue. If the entry in subfield OSEL is PRESEL, enter CONT to continue translations through UXLA. Enter NOCONT to immediately route translations through PCIXLA or PCITRK.
	CPMCALL	Y or N	Called party metering. If the entry in subfield OSEL is CPMCALL, datafill this refinement. Enter Y (yes) if calls are billed against the called party for intra-office calls. Enter N (no) for the default value of billing against the calling party for intraoffice calls.
	DDIDX	1 to 63 or DEFAULT	Destination discount index. If the entry in subfield OSEL is DDIDX, datafill this refinement. Enter the destination discount index number, which is an index in table AOCOPT.
	DEST	0 to 1023	Destination route list index. If the entry in subfield OSEL is DEST, datafill this refinement. Enter the number in the route list of the translation system that the call is routed to.
	IAA_INDEX	0 to 1024	Interadministration accounting index. If the entry in subfield OSEL is IAA, datafill this refinement. Enter the value that indexes the corresponding tuple in table IAACTRL.

ACCODE (continued)**Field descriptions for conditional datafill (Sheet 11 of 15)**

Field	Subfield	Entry	Explanation and action
	LNET	alphanumeric (1 to 8 characters)	Logical network. If the entry in subfield OSEL is LNET, datafill this refinement. Enter the logical network name that the call is on. The logical network name must be previously datafilled in table LNETWORK. The entry in this field is used by the international metering system to determine a tariff for the call.
	MAX	0 to 30	Maximum digits. If the entry in subfield OSEL is MM, datafill this refinement. Enter the maximum number of digits expected. This value includes the digits used to index the current tuple and must also include the prefix digits specified in the current tuple.
	MIN	0 to 30	Minimum digits. If the entry in subfield OSEL is MM, datafill this refinement. Enter the minimum number of digits expected. This value includes the digits used to index the current tuple and must also include the prefix digits specified in the current tuple.
	MZONE	0 to 63	Metering zone. If the entry in subfield OSEL is MZONE, datafill this refinement. Enter the metering zone of the call, in the logical network as defined by selector LNET. The entry in this field is an index (DESTZONE) in table MDESTIDX.

ACCODE (continued)**Field descriptions for conditional datafill (Sheet 12 of 15)**

Field	Subfield	Entry	Explanation and action
	NETSRV_ NAME	IPHS, DPHS, MOBILE, DA, TELEGRAM, or NCC	<p>Network service name. If the entry in subfield OSEL is NETSRV, datafill this refinement. The entry in this field determines the parameters in an outgoing IAM message.</p> <p>Enter IPHS to indicate a call to an independent personal handyphone system subscriber.</p> <p>Enter DPHS to indicate a call to a dependent personal handyphone system subscriber.</p> <p>Enter MOBILE to indicate a call to a mobile subscriber.</p> <p>Enter DA to indicate a call to the directory assistance operator.</p> <p>Enter TELEGRAM to indicate a call to the Telegram office.</p> <p>Enter NCC to indicate a call routed to one of the following networks:</p> <ul style="list-style-type: none"> • New Common Carrier serving international toll traffic • New Common Carrier serving national toll traffic
	NICRF	NICRF	<p>NIC routing function. This option allows transit calls prefixed with the NIC to access table PNINFO to route the call based on the NIC. Note that the NICRF and PNRF options are incompatible and cannot be datafilled on the same tuple.</p>
	NOA	INTL, LOCAL, NATL, or NET	<p>Nature of address. Enter the required called party nature of address as follows:</p> <ul style="list-style-type: none"> • INTL (international) • LOCAL (local) • NATL (national) • NET (Intelligent Network Services)

ACCODE (continued)**Field descriptions for conditional datafill (Sheet 13 of 15)**

Field	Subfield	Entry	Explanation and action
	ONNET	Y or N	<p>Call on virtual private network. If the entry in subfield OSEL is VPN, datafill this refinement. Enter Y if the call stays within the defined virtual private network. Otherwise, enter N.</p> <p>Overlapped outpulsing is supported only on off-network calls. Calls processed without subfield ONNET set to Y are off-network calls. Meridian Digital Centrex (MDC) calls are treated as off-network calls, and therefore overlapped outpulsing is supported for MDC calls.</p>
	PCCDR	0 to 9, B, C, D, E (1 to 3 digits)	<p>Pseudo country code digits. If the entry in subfield OSEL is PCC, datafill this refinement. Enter the three-digit pseudo country code (PCC). If a two-digit PCC is required, it must be padded by a leading zero.</p> <p>The pseudo country code is used to record a particular pseudo country code. This can be extracted for use by system logic later, for example, two-stage outpulsing.</p>
	PFDIGS	0 to 24	<p>Number of prefix digits. If the entry in subfield OSEL is PF, datafill this refinement. Enter the number of prefix digits. If prefix digits are identified in a previous table, this number is added to the existing value. Prefix digits are not used to index any further translation tables and are not outpulsed, but they do remain stored in call detail records (CDR).</p> <p>Note: If refinements PF and CONSUME are both datafilled for the same tuple, only the entry for the greater of the two values is processed; the other entry is ignored.</p>
	PFXAMA	0 to 4 digits or N	<p>Called party number prefix in AMA. If NOA is set to NTL, datafill PFXAMA with 0011.</p> <p>If NOA is set to NATL, datafill PFXAMA with 0.</p> <p>If NOA is set to LOCAL or NET, datafill PFXAMA with N.</p>

ACCODE (continued)**Field descriptions for conditional datafill (Sheet 14 of 15)**

Field	Subfield	Entry	Explanation and action
	PNRF	PNRFOPTS	Ported number recognitions function. Datafill the PNRFOPTS options vector and the INSNG subfields:
	INSNG	See subfields PREFIX and TRUNK_ACCESS_DIG	
	PREFIX	0 to 11	PREFIX indicates the number of leading digits to be copied from an originator's DN and prefixed to the translating number.
	TRUNK_ACCESS_DIG	0 to 9, or N	TRUNK_ACCESS_DIG enables the specification of a trunk access digit to be prefixed to the translating number after the INSNG_PREFIX function has been completed.
	PORTED	PORTED or blank	Number portability indicator. This entry indicates that the service number for this call has been ported.
	PRIVL	Y or N	Privileged user. If the entry in subfield OSEL is PRIVL, datafill this refinement. Enter Y (yes), if the user is a privileged user (for example, operator). Otherwise, enter N (no).
	SKIPDIGS	0 to 24	Skip digits. If the entry in subfield OSEL is EXTCIC, datafill this refinement. This field indicates the number of digits to skip before extracting the carrier digits from the digit stream. This field operates on the B (called) number, so it is assumed that the CIC is signaled as part of the B number.
	SOURCE	PRESUB or DIALED	Carrier identification code source. If the entry in subfield OSEL is EXTCIC, datafill this refinement. This field specifies the source of the CIC as follows: <ul style="list-style-type: none"> • PRESUB—presubscribed. The CIC is defined in table TRKGRP • DIALED—dialed. The CIC is entered by the subscriber when dialing a call

ACCODE (continued)**Field descriptions for conditional datafill (Sheet 15 of 15)**

Field	Subfield	Entry	Explanation and action
	STOPRTMR	Y or N	Stop remote timer. Enter Y to disable the address complete message (ACM) timer of the remote switch. The default value is N.
	XLAID	FREE, GENERIC1, GENERIC2, GENERIC3	AMA translation identifier. If the entry in subfield OSEL is AMAXLAID, datafill this refinement. Enter the AMA translation identifier to be used against table AMAXLAID.
	XLASYS	AC, AM, CT, FA, FT, NSC, OFC, PX	<p>Translation system. If the entry in subfield OSEL is XLT, datafill this refinement. Enter the next translation system to use, followed by a space, then datafill refinement XLANAME. Enter one of the following:</p> <ul style="list-style-type: none"> • AC (access) • AM (ambiguous) • CT (country) • FA (foreign area) • FT (utility) • NSC (number service code) • OFC (office) • PX (prefix) <p>Note: NIL is not a valid entry. NIL is used only to satisfy internal software functionality. NSC is not used in GL03.</p>
	XLANAME	alphanumeric (1 to 8 characters)	Translation name. If the entry in subfield OSEL is XLT, datafill this refinement. Enter the translation name of the table within the XLASYS to which the call is routed.

ACCODE (continued)**XLASEL = DBQ**

If the entry in field XLASEL is DBQ, datafill the following refinements.

Field descriptions for conditional datafill (Sheet 1 of 2)

Field	Subfield	Entry	Explanation and action
	OPT	see subfield	Options. This field is a vector consisting of up to ten options. Each option consists of subfield OSEL, and refinements that depend on the entry in subfield OSEL. For each option, specify the option selector (OSEL), followed by a space, then the refinements, each separated by a space. The entry is concluded by a \$. Datafill continues with field DFOP.
	OSEL	MM, NSC, or PF	Option selector. The following options can be selected: Enter MM, followed by a space, and datafill refinements MIN and MAX, if the minimum and maximum dialed digits are known. Enter NSC, followed by a space, and datafill refinement NSCODE, if a number service code operation is to be performed on a call. Enter PF, followed by a space, and datafill refinement PFDIGS if there are prefix digits in the digit stream.
	MAX	0 to 30	Maximum digits. If the entry in subfield OSEL is MM, datafill this refinement. Enter the maximum number of digits expected. This value includes the digits used to index the current tuple and must also include the prefix digits specified in the current tuple.
	MIN	0 to 30	Minimum digits. If the entry in subfield OSEL is MM, datafill this refinement. Enter the minimum number of digits expected. This value includes the digits used to index the current tuple and must also include the prefix digits specified in the current tuple.

ACCODE (continued)**Field descriptions for conditional datafill (Sheet 2 of 2)**

Field	Subfield	Entry	Explanation and action
	NSCODE	AIN, 800P, E008, E800, MAP_HLR, MAP_MSC, MAP_VLR, PVN, MAPHLR, REPLDIGS, or VPN	<p>Number service code. If the entry in subfield OSEL is NSC, enter the required number service code for the operation to be performed on the call, as follows:</p> <ul style="list-style-type: none"> • AIN (advanced intelligent network) • 800P (800+) • E008 (Enhanced 008) • E800 (Enhanced 800) • MAP_HLR (mobile application part home location register) • MAP_MSC (mobile application part mobile service switching center) • MAP_VLR (mobile application part visitor location register) • MAPHLR (appears only if the MAP Interworking to BTUP feature is present on the switch) • PVN (private virtual network) • REPLDIGS (replace digits) • VPN (Australian virtual private network)
	PFDIGS	0 to 24	<p>Number of prefix digits. If the entry in subfield OSEL is PF, datafill this refinement. Enter the number of prefix digits. If prefix digits are identified in a previous table, this number is added to the existing value. Prefix digits are not used to index any further translation tables and are not outpulsed, but they do remain stored in call detail records (CDR).</p>

XLASEL = DMOD

If the entry in subfield XLASEL is DMOD, datafill the following refinements.

If options CDNRTE and CPCRTE are both present in one tuple in table xxCODE, call processing accesses routing tables in the following order: table CPCUXLA is accessed first. If no match is found, table CDNUXLA is accessed next.

ACCODE (continued)

If options SETCDN and CDNRTE are both present in one tuple in table xxCODE, call processing accesses table CDNUXLA first, before the SETCDN option sets the called number name (CDNNAME).

Field descriptions for conditional datafill (Sheet 1 of 8)

Field	Subfield	Entry	Explanation and action
	OPT	see subfield	Options. This field is a vector consisting of up to ten options. Each option consists of subfield OSEL, and refinements that depend on the entry in subfield OSEL. For each option, specify the option selector (OSEL), followed by a space, and the refinements, each separated by a space. The entry is concluded by a \$. Datafill continues with field DFOP.
	OSEL	AFTER, CATRTE, CDNRTE, CGNDM, CHGIND, CONSUME, COODM, CPCRTE, DEL, EXTCIC, INSRT, PF, RBP, REPL, SETCDN, VPNREPL, VPNXLT, or XLT	<p>Option selector. The following options can be selected:</p> <p>Enter AFTER, followed by a space, and datafill refinement AFTER if a certain number of digits must be skipped before modifying the digit stream.</p> <p>Enter CATRTE to allow charge category routing in IBN translations.</p> <p>Enter CDNRTE to route using the called number name (CDNNAME) from table CDNCHAR. If the CDNNAME is present on the incoming call or is set by the SETCDN option, translation proceeds to table CDNUXLA.</p> <p>Enter CGNDM, followed by a space, and datafill refinements PREFXCLI and INSRTCLI to remove digits from the calling line identification (CLI) and insert a datafilled digit string of up to five digits in the prefix string. The total length of the CLI and the digit string can be up to 18 digits. A modified CLI and digit string of more than 18 digits routes the call to treatment.</p>

ACCODE (continued)

Field descriptions for conditional datafill (Sheet 2 of 8)

Field	Subfield	Entry	Explanation and action
			<p>Enter CONSUME, followed by a space, and datafill refinement CONDIGS to specify the number of digits that are consumed during translation.</p>
			<p>Enter COODM, followed by a space, and datafill refinement SERVICE to replace the dialed emergency code by the emergency number stored in table LAC.</p>
			<p>Note: Option selector COODM must be combined with option XLT to guarantee that translation continues with the modified number. Selector COODM cannot be combined with any other option.</p>
			<p>Enter CPCRTE to route using the calling party category (CPCNAME) from table CPCCHAR. If the CPCNAME is present on the incoming call, translation proceeds to table CPCUXLA.</p>
			<p>Enter DEL, followed by a space, and datafill refinement DELDIGS. Further digits are accepted from the agent, and overlapped outpulsing is not affected. Digits being deleted are processed before those being inserted.</p>
			<p>Enter EXTCIC, followed by a space, and datafill refinements SOURCE, SKIPDIGS, and CICSIZE. EXTCIC is the external carrier identification code that indicates a long distance carrier in the global environment. This option is only supported for TOPS calls. For further information, refer to functionality Global Competitive Access, GOS00006.</p>

ACCODE (continued)**Field descriptions for conditional datafill (Sheet 3 of 8)**

Field	Subfield	Entry	Explanation and action
			<p>Enter INSRT, followed by a space, and datafill refinement INSRDIGS. Further digits are accepted from the agent, and overlapped outputting is not affected. Digits being deleted are processed before those being inserted.</p> <p>Note: Digit insertion is done in the actual digit stream, and the changes are reflected in call detail records. Replacement and insertion cannot be datafilled in the same tuple. If both options are datafilled, the second option in the tuple is used.</p> <p>Enter PF, followed by a space, and datafill refinement PFDIGS, if there are prefix digits in the digit stream.</p> <p>Enter RBP without refinements. The entry RBP is used when a call is to be marked as Ringback Price. The RBP entry in table ACCODE suffixes a hexadecimal E to the calling digits for a call that translates using a tuple with option RBP.</p> <p>Enter REPL and datafill refinement REPLDIGS. Overlapped outputting is disabled, and all digits are collected before continuing.</p> <p>Note: Digit replacement occurs in the actual digit stream, and the changes are reflected in call detail records. Replacement and insertion cannot be datafilled in the same tuple. If both options are datafilled, the second option in the tuple is used.</p>

ACCODE (continued)

Field descriptions for conditional datafill (Sheet 4 of 8)

Field	Subfield	Entry	Explanation and action
			<p>Enter SETCDN to trigger the setting of outgoing called party characteristics. This option assigns the called number name (CDNNAME) from table CDNCHAR to the call. If the CDNRTE option is subsequently encountered, the CDNNAME is used to route the call.</p> <p>You can use the SETCDN option to allow CDN routing when incoming agents such as DPNSS or BTUP are not available in table CDNCHAR.</p> <p>Enter VPNREPL to replace the called party digits with the VPN called party digits conveyed across the public network by the QSIG Feature Transparency mechanism.</p> <p>Enter VPNXLT to replace the current translation system and translator name with the values stored in table BGIDMAP. The entry to table BGIDMAP is addressed by the NNI BGID and SIGNIFICANCE information received in the originating signaling for the call.</p> <p>Note: The VPNXLT and XLT options must not both exist in the same tuple.</p> <p>Enter XLT, followed by a space, and datafill refinement XLASYS if the call proceeds to another translation system.</p>

ACCODE (continued)**Field descriptions for conditional datafill (Sheet 5 of 8)**

Field	Subfield	Entry	Explanation and action
	AFTER	0 to 29	<p>After. If the entry in subfield OSEL is AFTER, datafill this refinement. Enter the number of digits to skip before doing the modification. The default case is to calculate the new prefix fence, and replace, insert, or delete digits after the fence (for example, starting at the next digit). Option AFTER is an additional number of digits to skip before doing the modification. Option AFTER refers to the option datafilled immediately before it. For example:</p> <p>>DMOD DEL 3 AFTER 2 INSRT 11</p> <p>skips two digits, deletes the next three, and inserts digits 11 at the beginning of the digit string. The result when applied to 234567 is 23117.</p> <p>Note: Datafilling this refinement with 0 (the default value), displays the following error message:</p> <pre>Too few digits for AFTER UNSUPPORTED OPTION AT: # PROCESSING ERROR UNEXPECTED ERROR CONDITION</pre>
	CATRTE	CATRTE	Enter CATRTE to allow charge category routing in IBN translations.
	CDNNAME	alphanumeric string	If the entry in subfield OSEL is SETCDN, enter data for the CDNNAME refinement to allow CDN routing.

ACCODE (continued)**Field descriptions for conditional datafill (Sheet 6 of 8)**

Field	Subfield	Entry	Explanation and action
	CHGIND	ASIS, CHG, or NOCHG	<p>If the entry in subfield OSEL is CHGIND, enter data for refinement CHGIND. The CHGIND refinement indicates whether to override the value of the charge indicator in the Backward Call indicators.</p> <p>Datafill the CHGIND field with the following values:</p> <ul style="list-style-type: none"> • ASIS—treat charge indicator as is • CHG—treat charge indicator as charge • NOCHG—treat charge indicator as no charge
	CICSIZE	1 to 4	<p>CIC size. If the entry in subfield OSEL is EXTCIC, datafill this refinement. This field indicates the number of digits in the CIC. This field operates on the B (called) number, so it is assumed that the CIC is signaled as part of the B number.</p> <p>The MAP display indicates the range is 0 to 4; however, the system does not allow 0.</p>
	CONDIGS	numeric (0 to 29 digits)	<p>Consumed digits. If the entry in subfield OSEL is CONSUME, datafill this refinement. Enter a number to explicitly define the number of digits consumed during call processing.</p>
	DELDIGS	0 to 29	<p>Delete digits. If the entry in subfield OSEL is DEL, datafill this refinement. Enter the number of digits to be deleted, after skipping digits to be left unprocessed.</p>
	INSRDIGS	numeric (0 to 29 digits)	<p>Insert digits. If the entry in subfield OSEL is INSRT, datafill this refinement. Enter the digits to be inserted, after skipping digits to be left unprocessed.</p>
	INSRTCLI	1 to 5 digits or \$	<p>Insert calling line identification. If the entry in subfield OSEL is CGNDM, datafill this refinement. Enter the new string to insert as the prefix onto the CLI. Enter \$ to specify that no digit string is inserted.</p>

ACCODE (continued)**Field descriptions for conditional datafill (Sheet 7 of 8)**

Field	Subfield	Entry	Explanation and action
	PFDIGS	0 to 24	<p>Number of prefix digits. If the entry in subfield OSEL is PF, datafill this refinement. Enter the number of prefix digits. If prefix digits are identified in a previous table, this number is added to the existing value. Prefix digits are not used to index any further translation tables and are not outpulsed, but they do remain stored in call detail records (CDR).</p> <p>Note: If refinements PF and CONSUME are both datafilled for the same tuple, only the entry for the greater of the two values is processed; the other entry is ignored.</p>
	PREFXCLI	0 to 18	<p>Prefix calling line identification. If the entry in subfield OSEL is CGNDM, datafill this refinement. Enter the number of prefix digits to delete.</p>
	REPLDIGS	numeric (0 to 30 digits)	<p>Replace digits. If the entry in subfield OSEL is REPL, datafill this refinement. Enter the digits that replace the existing digits, after skipping digits to be left unprocessed.</p>
	SERVICE	alphanumeric (1 to 8 characters)	<p>COODM service. If the entry in subfield OSEL is COODM, datafill this refinement. Enter the emergency service name. Emergency service names are listed in field EMRGSERV in table LAC.</p>
	SKIPDIGS	0 to 24	<p>Skip digits. If the entry in subfield OSEL is EXTCIC, datafill this refinement. This field indicates the number of digits to skip before extracting the carrier digits from the digit stream. This field operates on the B (called) number, so it is assumed that the CIC is signaled as part of the B number.</p>

ACCODE (continued)**Field descriptions for conditional datafill (Sheet 8 of 8)**

Field	Subfield	Entry	Explanation and action
	SOURCE	PRESUB or DIALED	<p>Carrier identification code source. If the entry in subfield OSEL is EXTCIC, datafill this refinement. This field specifies the source of the CIC as follows:</p> <ul style="list-style-type: none"> • PRESUB—presubscribed. The CIC is defined in table TRKGRP. • DIALED—dialed. The CIC is entered by the subscriber when dialing a call.
	XLASYS	AC, AM, CT, FA, FT, NSC, OFC, or PX	<p>Translation system. If the entry in subfield OSEL is XLT, datafill this refinement. Enter the next translation system to use, followed by a space, and datafill subfield XLANAME (the instance of the translation system).</p> <p>The choice of translation systems is as follows:</p> <ul style="list-style-type: none"> • AC (access) • AM (ambiguous) • CT (country) • FA (foreign area) • FT (utility) • NSC (number service code) • OFC (office) • PX (prefix) <p>Note: NIL is not a valid entry. NIL is used only to satisfy internal software functionality. NSC is not used in GL03.</p>
	XLANAME	alphanumeric (1 to 8 characters)	<p>Translation name. If the entry in subfield OSEL is XLT, datafill this refinement. Enter the translation name of the table within the XLASYS to which the call is routed.</p>

XLASEL = DNRTE

If the entry in subfield XLASEL is DNRTE, datafill the following refinements. Selector DNRTE allows translation to continue in table DNINV. Through this translation, calls can be terminated at directory numbers (DN) datafilled in table DNINV.

ACCODE (continued)

After datafilling table ACHEAD, table DNINV must be datafilled before selector DNRTE is datafilled in table ACCODE.

Table AMAXLAID must be datafilled prior to selecting option AMAXLAID in field OSEL.

Field descriptions for conditional datafill (Sheet 1 of 4)

Field	Subfield	Entry	Explanation and action
	OPT	see subfield	Options. This field is a vector consisting of up to ten options. Each option consists of subfield OSEL and refinements that depend on the entry in subfield OSEL. For each option, specify the option selector (OSEL), followed by a space, and the refinements, each separated by a space. The entry is concluded by a \$. Datafill continues with field DFOP.
	OSEL	AMAXLAID, CAMA, CLASS, DN, MM, PF, SF, or ALLOWOVLP	<p>Option selector. The following options can be selected:</p> <p>Enter ALLOWOVLP to allow call routing based on MIN digits instead of MAX. The ALLOWOVLP option does not have subfields.</p> <p>Enter AMAXLAID, followed by a space, and datafill refinement XLAID to specify an automatic message accounting (AMA) identity from within table AMAXLAID.</p> <p>Enter CAMA, followed by a space, and datafill refinement CLDFMT. The entry in CLDFMT indicates whether the international centralized AMA (ICAMA) record is generated with the originally signaled DN or the final public switched telephone network (PSTN) number.</p> <p>Enter CLASS, followed by a space, and datafill refinement CLASS if the class of the dialed digits is determined.</p> <p>Enter DN, followed by a space, and datafill refinements SNPA and OFC for the DN that the call is routed to.</p>

ACCODE (continued)

Field descriptions for conditional datafill (Sheet 2 of 4)

Field	Subfield	Entry	Explanation and action
			<p>Enter MM, followed by a space, and datafill refinements MIN and MAX if the minimum and maximum dialed digits are known.</p> <p>Enter PF, followed by a space, and datafill refinement PFDIGS if there are prefix digits in the digit stream.</p> <p>Enter SF, followed by a space, and datafill refinement SFDIGS to indicate the beginning of the station code digits.</p>
	CLDFMT	CURRENT or POSTXLA	<p>Called format. If the entry in subfield OSEL is CAMA, enter either CURRENT or POSTXLA to produce the required ICAMA record format.</p> <p>If the entry is CURRENT, an ICAMA record is produced with the signaled DN (without translation).</p> <p>If the entry is POSTXLA, an ICAMA record is produced with the public switched telephone network (PSTN) number resulting from translations.</p>

ACCODE (continued)**Field descriptions for conditional datafill (Sheet 3 of 4)**

Field	Subfield	Entry	Explanation and action
	CLASS	ATT, CNTL, COLL, DATT, EMRG, IAGRP, ICNTL, INTL, IOPRA, LCL, NATL, OPRA, RURAL, SPEC, UNKW, or URBAN	<p>Translation class. If the entry in subfield OSEL is CLASS, datafill this refinement. Enter the translation class determined by the dialed digits. This can be used for screening or billing purposes as described under CLASS in screening and charging options.</p> <ul style="list-style-type: none"> • ATT (attendant console) • CNTL (continental) • COLL (collect) • DATT (dial attendant) • EMRG (emergency) • IAGRP (interagent group) • ICNTL (intercontinental) • INTL (international) • IOPRA (international operator assisted) • LCL (local) • NATL (national) • OPRA (operator assisted) • RURAL (rural) • SPEC (special) • UNKW (unknown) • URBAN (urban)
	OFC	numeric (1 to 7 digits)	Seven-digit office code. If the entry in subfield OSEL is DN, enter the office code for the DN that the call is routed to.
	MAX	0 to 30	Maximum digits. If the entry in subfield OSEL is MM, datafill this refinement. Enter the maximum number of digits expected. This value includes the digits used to index the current tuple and must also include the prefix digits specified in the current tuple.

ACCODE (continued)**Field descriptions for conditional datafill (Sheet 4 of 4)**

Field	Subfield	Entry	Explanation and action
	MIN	0 to 30	Minimum digits. If the entry in subfield OSEL is MM, datafill this refinement. Enter the minimum number of digits expected. This value includes the digits used to index the current tuple and must also include the prefix digits specified in the current tuple.
	OFC	numeric (1 to 7 digits)	Seven-digit office code. If the entry in subfield OSEL is DN, enter the office code for the DN that the call is routed to.
	OFC	numeric (1 to 7 digits)	Seven-digit office code. If the entry in subfield OSEL is DN, enter the office code for the DN that the call is routed to.
	PFDIGS	0 to 24	Number of prefix digits. If the entry in subfield OSEL is PF, datafill this refinement. Enter the number of prefix digits. If prefix digits are identified in a previous table, this number is added to the existing value. Prefix digits are not used to index any further translation tables and are not outpulsed, but they do remain stored in call detail records (CDR).
	SFDIGS	0 to 29	Station fence digits. If the entry in subfield OSEL is SF, datafill this refinement. Enter a number to indicate the number of digits to advance past the start of the digits that index into the tuple. During call processing, the station code digits consist of all digits beyond this indicator to the end of the dialed digits. If option SF is not datafilled, the last four digits are used as the station code.
	SNPA	000 to 999 (3 digits)	Serving number plan area. If the entry in subfield OSEL is DN, enter the required serving number plan area (SNPA). This number must be datafilled in table HNPACONT or in table SNPANAME.
	XLAIID	FREE, GENERIC1, GENERIC2, GENERIC3	AMA translation identifier. If the entry in subfield OSEL is AMAXLAID, enter the AMA translation identifier to be used against table AMAXLAID.

ACCODE (continued)**XLASEL = FEAT**

If the entry in field XLASEL is FEAT, datafill the following refinements.

Field descriptions for conditional datafill (Sheet 1 of 3)

Field	Subfield	Entry	Explanation and action
	OPT	see subfield	Options. This field is a vector consisting of up to ten options. Each option consists of subfield OSEL, and refinements that depend on the entry in subfield OSEL. For each option, specify the option selector (OSEL), followed by a space, and the refinements, each separated by a space. The entry is concluded by a \$. Datafill continues with field DFOP.
	OSEL	FTR, FUNC, MM, or PF	<p>Option selector. The following options can be selected:</p> <p>Enter FTR, followed by a space, and datafill refinement FTR to identify the international line feature.</p> <p>Enter FTR, followed by a space, and datafill refinement VSC to indicate that the international line feature needs translation in table XLA.</p> <p>Enter FUNC, followed by a space, and datafill refinement FUNC to identify the international line feature function.</p> <p>Enter MM, followed by a space, and datafill refinements MIN and MAX if the minimum and maximum dialed digits are known.</p> <p>Enter PF, followed by a space, and datafill refinement PFDIGS if there are prefix digits in the digit stream.</p>

ACCODE (continued)**Field descriptions for conditional datafill (Sheet 2 of 3)**

Field	Subfield	Entry	Explanation and action
	FTR	CALLBACK, CALLCHAR, CLCTDIGS, FOC, FTD, FTR, JES, NTC, TLC, VALIDATE, VMWI, or VSC	<p>Feature name. If the entry in subfield OSEL is FTR, enter an international line feature name shown below.</p> <ul style="list-style-type: none"> • CALLBACK (Call Back) • CALLCHAR (Call Characters) • CLCTDIGS (Collect Digits) • FOC (Faultsman Line Open Circuit Test) • FTD (Faultsman Digit Test) • FTR (Faultsman Ring Back) • JES (Japan Emergency Service) • NTC (Notify Time Charges) • TLC (Trunk Logic Circuit) • VALIDATE (not used in GL03) • VMWI (Voice Mail Waiting Indication) • VSC (Vertical service code)
	FUNC	ACT, DEACT, DELETE, INTER, PROG, or USAGE	<p>Feature function code. If subfield OSEL is set to FUNC, enter one of the international line feature function codes from the following list:</p> <ul style="list-style-type: none"> • ACT (activate) • DEACT (deactivate) • DELETE (delete) • INTER (interrogate) • PROG (programming) • USAGE (usage)
	MAX	0 to 30	<p>Maximum digits. If the entry in subfield OSEL is MM, datafill this refinement. Enter the maximum number of digits expected following MIN entry and a space. This value includes the digits used to index the current tuple and must also include the prefix digits specified in the current tuple.</p>

ACCODE (continued)**Field descriptions for conditional datafill (Sheet 3 of 3)**

Field	Subfield	Entry	Explanation and action
	MIN	0 to 30	Minimum digits. If the entry in subfield OSEL is MM, datafill this refinement. Enter the minimum number of digits expected. This value includes the digits used to index the current tuple and must also include the prefix digits specified in the current tuple.
	PFDIGS	0 to 24	Number of prefix digits . If the entry in subfield OSEL is PF, datafill this refinement. Enter the number of prefix digits. If prefix digits are identified in a previous table, this number is added to the existing value. Prefix digits are not used to index any further translation tables and are not outputted, but they remain stored in call detail records (CDR).

XLASEL = FEATINFO

If the entry in subfield XLASEL is FEATINFO, datafill the following refinements. Selector FEATINFO makes use of table DNSCRN to store information against DNs, which is used during call processing to determine how to proceed with the call. The screening function is triggered by selector FEATINFO in the universal translation tables. The options available with this selector are shown below.

Field descriptions for conditional datafill (Sheet 1 of 9)

Field	Subfield	Entry	Explanation and action
	FTR	CALLBACK, CALLCHAR, CLCTDIGS, JES, NTC, TLC, VALIDATE, or VMWI	<p>Feature name. Enter CALLBACK to enable originator callback during translations. Datafill subfield CALLBACK_OPTION and its refinements, then datafill subfields PFDIGS, MINDIGS, MAXDIGS, and TABREF.</p> <p>Enter CALLCHAR to modify all signaling characteristics. Datafill subfields CLLCHROP, PFDIGS, MINDIGS, MAXDIGS, and TABREF.</p> <p>Enter CLCTDIGS to collect digits from the call originator and add them to the called digits stream for translation. Datafill subfields CLDGMIN, CLDGMAX, CLCTDIGS_OPTION, PFDIGS, MINDIGS, MAXDIGS, and TABREF.</p>

ACCODE (continued)**Field descriptions for conditional datafill (Sheet 2 of 9)**

Field	Subfield	Entry	Explanation and action
			<p>Enter JES to activate the Japan Emergency Service feature. Datafill refinements PFDIGS and TABREF.</p> <p>Enter NTC to notify the originating subscriber of applicable time and charges after the call terminates. Datafill subfield SUBOPT_NAME and its refinement, then datafill subfields PFDIGS, MINDIGS, MAXDIGS, and TABREF.</p> <p>Enter TLC to enable the test line call feature, which provides audible ringback tone followed by dial tone after specified durations. Datafill subfields RING_BACK_TONE_DUR, DIAL_TONE_DUR, TLC_PREFIX_DIGS, TLC_NUM_DIGS, and TLC_CHARGE.</p> <p>Enter VALIDATE, and datafill subfield VALADTOP and its refinements. Datafill subfields PFDIGS, MINDIGS, MAXDIGS, and TABREF.</p> <p>Enter VMWI, followed by a space, and enter data for subfields STATUS, VMDN, or PFDIG. This command routes message waiting or cleared indication calls to the VMWI.</p>
	CALLBACK_OPTION	CLCTDEST or NIL	<p>Callback option. If the entry in field FTR is CALLBACK, datafill this option. Enter CLCTDEST to call back the subscriber and collect destination digits. Datafill subfields CLDGMIN, CLDGMAX, DISC_ANNC_TRK, PROMPT_ANNC_TRK, and SEND_ANM. Otherwise, enter NIL.</p>
	CLDGMIN	1 to 24	<p>Minimum collected digits. Enter the minimum number of digits to be collected and entered into the called digit stream.</p>
	CLDGMAX	1 to 24	<p>Maximum collected digits. Enter maximum number of digits to be collected and written into the called digit stream. The value cannot be less than CLDGMIN.</p>

ACCODE (continued)**Field descriptions for conditional datafill (Sheet 3 of 9)**

Field	Subfield	Entry	Explanation and action
	DISC_ANNC_TRK	alphanumeric (1 to 16 characters)	Disconnect announcement trunk. Enter trunk common language location identifier (CLLI).
	PROMPT_ANNC_TRK	alphanumeric (1 to 16 characters)	Prompt announcement trunk. Enter trunk the common language location identifier (CLLI).
	SEND_ANM	Y or N	Send answer message. Enter Y (yes) or N (no).
	CLLCHROP	NOCHGMSG or EARLYCPG	Call characteristics. If the entry in field FTR is CALLCHAR, datafill this option. Enter NOCHGMSG to block backward CHG message. Enter EARLYCPG to specify that a call progress (CPG) message is issued in the backwards direction before an address complete message (ACM) is sent. The CPG message is permitted before an ACM in certain ISDN user part (ISUP) variants to establish a bidirectional speech path and to stop the T7 timer.
	CLCTDIGS_OPTION	NIL or \$	Collect digits option. If the entry in field FTR is CLCTDIGS, datafill this option. Enter NIL or enter \$ to proceed to the next option.
	SUBOPT_NAME	DUR_ADJ	Suboption name. If the entry in field FTR is NTC, datafill this option. Enter DUR_ADJ to specify the duration adjustment for NTC and datafill subfield DURATION_ADJ.
	DURATION_ADJ	0 to 99	Duration adjustment. Enter the time in seconds.
	RING_BACK_TONE_DUR	1 to 255	Ringback tone duration. If the entry in field FTR is TLC, datafill this option. Enter the time, in seconds, that ringback tone is provided to the originator.
	DIAL_TONE_DUR	1 to 255	Dial tone duration. If the entry in field FTR is TLC, datafill this option. Enter the time, in seconds, that dial tone is provided to the originator.

ACCODE (continued)**Field descriptions for conditional datafill (Sheet 4 of 9)**

Field	Subfield	Entry	Explanation and action
	TLC_PREFIX_ DIGS	0 to 18	Prefix digits in called number. If the entry in field FTR is TLC, datafill this option. Enter the number of digits to advance the prefix fence to detect the charge message digits when CPC = PAYPHONE.
	TLC_NUM_ DIGS	numeric (3 or 4) Japan only	Test line call number of digits. Enter the number of dialed digits to be transferred to the NCCI#7 CHG message. This is also the number of digits stored in the LMNNUM field of the SMDR #DE record.
	TLC_CHARGE	Y or N	Test line call charge indicator. The TLC_CHARGE field indicates the billing status of an ISUP test call. Enter Y if the call is billable. Enter N if the call is not billable. The default value for this field is N.
	OPT	see subfield VALDATOP	Options. If the entry in field FTR is VALIDATE, datafill this option. This field is a vector consisting of up to five options. Each option consists of subfield VALDATOP, and refinements that depend on the entry in subfield VALDATOP. For each option, specify VALDATOP, followed by a space, then the refinements, each separated by a space. The entry is concluded by a \$ and datafill continues with field DFOP.
	VALDATOP	BCSCRN, CALLED, CLDTCCLG, CLISERV CUSTMOD, LCASCRN, NOCHARGE, PRESEL, SCRNLNTH, SUBSCRN, TCNOTSCR, THIRDPTY, VERDEST, V3PTYBIL	Validate option. Enter a list of up to five options. The options specify what characteristics are to be considered when screening the call. Enter \$ to signify the end of the list. Note: Selector VALIDATE is traversed only once for each call. Enter BCSCRN and datafill refinement BCOPTS to identify the bearer capability name.

ACCODE (continued)

Field descriptions for conditional datafill (Sheet 5 of 9)

Field	Subfield	Entry	Explanation and action
			<p>Enter CALLED to indicate the number to be used for screening. The SUBSCRN options are used to specify the subscriber types allowed to receive the call.</p> <p>Note: When using option CALLED, there must be no further digit manipulation after selector VALIDATE is encountered in translations.</p> <p>If option CALLED is not entered, then the calling party number is used for screening and the SUBSCRN options are used to specify the subscriber types allowed to make the call.</p> <p>Note: Pay phone subscribers are treated as general subscribers if option CALLED is specified.</p> <p>Enter CLDTCOLG, followed by a space, to copy digits from the called to the calling digit stream, and datafill options OFFSET and COUNT.</p> <p>Enter CLISERV, followed by a space, and enter data for subfield SERVNAME. The CLISERV field indicates the name of the client server.</p> <p>Enter CUSTMOD, followed by a space, to alter the internal network class of service (NCOS) and customer group to new value for a given directory number (DN) based on the CUSTINFO attribute in table DNSCRN. The source of the DN used as an index into table DNSCRN is determined by the VALIDATE datafill. Datafill refinement CUSTSCRN.</p> <p>Enter LCASCRN, followed by a space, to enable local calling area screening. The called and calling numbers are checked against tables LCARNAME and LCASCRN to determine if the numbers are local to each other, and whether the call should be denied or allowed to continue routing.</p>

ACCODE (continued)

Field descriptions for conditional datafill (Sheet 6 of 9)

Field	Subfield	Entry	Explanation and action
			<p>Enter NOCHARGE, followed by a space, to indicate that the call is nonbillable.</p> <p>Note: If both NOCHARGE and THIRDPITY options are specified, NOCHARGE takes precedence.</p> <p>Enter PRESEL to allow screening for the PRESEL attribute in table DNSCRN.</p> <p>Enter SCRNLNTH, followed by a space, and datafill refinement MINLNGTH to specify the minimum length of the number being screened.</p> <p>Enter SUBSCRN, followed by a space, and datafill up to three multiples of the following subscriber types: GENERAL, PAYPHONE, PERSONAL, and MOBILE. Enter \$ after entering SUBSCRN to indicate that no subscriber types are permitted to make or receive the call.</p> <p>Enter TCNOTSCR to indicate that calls with CPC set to Test Call are not screened.</p> <p>Enter THIRDPITY to indicate that automatic third party billing is used. Table DNSCRN is checked for attribute UNPAID.</p> <p>Note: If both NOCHARGE and THIRDPITY options are specified, NOCHARGE takes precedence.</p> <p>Note: Payphone subscribers are treated as general subscribers if option CALLED is specified.</p> <p>Enter VERDEST to verify the destination of a call. Called digits are checked against ADDCODE entries in table DNSCRN.</p> <p>Note: NIL appears on the switch range but is not a valid entry. The value NIL is used only to satisfy internal software requirements.</p>

ACCODE (continued)**Field descriptions for conditional datafill (Sheet 7 of 9)**

Field	Subfield	Entry	Explanation and action
	STATUS	WAITING or CLEARED	VMWI status typeEnter WAITING for message waiting indication. Enter CLEARED for message cleared indication.
	VMDN	numeric0 to 18 digits	Digit register. Enter the voice mail DN used to retrieve messages from the voice platform. The DN can contain up to 18 digits.
	PFDIG	numeric,0 to 24 digits	Extended digit count. Enter the subscriber's DN.
	BCOPTS	alphanumeric (1 to 8 characters)	Bearer capability option. If the entry in field VALDATOP is BCSCRN, datafill this refinement. Enter up to four bearer capability names.
	COUNT	0 to 13	If the entry in field VALDATOP is CLDTCCLG, enter data for this refinement. Enter a maximum of 13 digits for the called to calling number.
	CUSTSCRN	Y or N	Customer screen. Enter Y to block calls that are not subscribed to the switched on-net services if attempting a switched on-net call. If the DN being screened is not present in table DNSCRN, the call is rejected with the Call Not Allowed (CNAD) treatment. The internal NCOS and CUSTGRP associated with the call are altered to the values found in the CUSTINFO attribute if present for the given DN in table DNSCRN. The DN used to index table DNSCRN can be the subscriber calling line identification (CLI) or the dialed number. The source of the DN is determined by the datafill of field VALIDATE. Enter N if no screening is performed.
<p>Note: The FEATINFO values CCANN, CCARD, CCSDT, DAFOP, FAXSUP, FAXTEST, INBFAX, INBFD, INTLFD, ISD, ISDTST, ISDVRE, OUTBFAX, OUTBFD, PB3RDPTY, PBCALL, PBISD, PBISDVRE, and PBTST are valid only in DMS-250 switching offices. Additional DMS-250 parameters are listed in the DMS-250 specific data schema NTPs.</p>			

ACCODE (continued)**Field descriptions for conditional datafill (Sheet 8 of 9)**

Field	Subfield	Entry	Explanation and action
	MINLNTH	0 to 18 values from 0 to 30 are possible in APC software loads	Minimum length. If the entry in field VALDATOP is SCRNLNTH, enter the minimum number of digits required in number being screened.
	OFFSET	0 to 30	If the entry in field VALDATOP is CLDTCCLG, enter data for this refinement. Enter a maximum of 30 digits.
	SERVNAME	alphanumeric string	If the entry in field VALDATOP is CLISERV, enter data for this refinement. Enter the name of a client server.
	SUBSCTYP	GENERAL, PAYPHONE, PERSONAL, or MOBILE	Subscriber type. Enter subscriber type, followed by a space, and datafill refinements WHITLIST, CHKBLKCL, CHKUNPD, and CHKCCR. This option allows you to specify which subscriber types are permitted to make or receive a call and whether the subscriber's standing is important for a call.
	WHITLIST	Y or N	Whether it list. Enter Y (yes) to indicate that the subscriber's directory number must be datafilled in table DNSCRN. Otherwise, enter N (no).
	CHKBLKCL	Y or N	Check block call. Enter Y to check if the subscriber has subscribed to all services for which this tuple is being used (BLKCALL attribute in table DNSCRN). Otherwise, enter N.
	CHKUNPD	Y or N	Check unpaid. Enter Y to check if the subscriber has paid his bills. Otherwise, enter N.
	CHKCCR	Y or N	Check cumulative call restriction. Enter Y to check the subscriber's cumulative charge limit. Otherwise, enter N.
	PFDIGS	0 to 24	Prefix digits. Enter the number of prefix digits present at this point in the call. Prefix digits are not used to index any further translation tables and are not outpulsed, but they remain stored in call detail records (CDR).

ACCODE (continued)**Field descriptions for conditional datafill (Sheet 9 of 9)**

Field	Subfield	Entry	Explanation and action
	MINDIGS	0 to 30	Minimum digits. Enter the minimum number of digits expected. This value includes the digits used to index the current tuple and must also include the prefix digits specified in the current tuple.
	MAXDIGS	0 to 30	Maximum digits. Enter the maximum number of digits expected. This value includes the digits used to index the current tuple and must also include the prefix digits specified in the current tuple.
	TABREF	see subfields	Table reference. This field consists of subfields XLASYS and XLANAME.
	XLASYS	AC, AM, CT, FA, FT, NSC, OFC, or PX	<p>Translation system. Enter the next translation system to use, followed by a space, and datafill subfield XLANAME (the instance of the translation system).</p> <p>The choice of translation systems is as follows:</p> <ul style="list-style-type: none"> • AC (access) • AM (ambiguous) • CT (country) • FA (foreign area) • FT (utility) • NSC (number service code) • OFC (office) • PX (prefix) <p>Note: NIL is not a valid entry. NIL is used only to satisfy internal software functionality.</p>
	XLANAME	alphanumeric (1 to 8 characters)	Translation name. Enter the translation name of the table instance within the XLASYS to which the call is routed.

ACCODE (continued)**XLASEL = HRC**

If the entry in subfield XLASEL is HRC, datafill the following refinements.

Field descriptions for conditional datafill (Sheet 1 of 2)

Field	Subfield	Entry	Explanation and action
	OPT	see subfield	Options. This field contains subfield OSEL, and refinements that depend on the entry in subfield OSEL. The entry is concluded by a \$ and datafill continues with field DFOP.
	OSEL	XLT, PFBILL	Option selector. If the call proceeds to another translation system, enter XLT, followed by a space, and datafill refinement XLASYS. Also complete an entry for option selector PFBILL.
	XLASYS	AC, AM, CT, FA, FT, NSC, OFC, PX	<p>Translation system. If option selector XLT is entered in subfield OSEL, datafill this refinement. Enter the next translation system to use, followed by a space, then datafill refinement XLANAME. Enter one of the following:</p> <ul style="list-style-type: none"> • AC (access) • AM (ambiguous) • CT (country) • FA (foreign area) • FT (utility) • NSC (number service code) • OFC (office) • PX (prefix) <p>Note: NIL is not a valid entry. NIL is used only to satisfy internal software functionality. NSC is not used in GL03.</p>

ACCODE (continued)**Field descriptions for conditional datafill (Sheet 2 of 2)**

Field	Subfield	Entry	Explanation and action
	XLANAME	alphanumeric (1 to 8 characters)	Translation name. If XLT is entered in subfield OSEL, datafill this refinement. Enter the translation name of the table within the XLASYS to which the call is routed.
	PFBILL	Y or N	Prefix billing option. Enter PFBILL, followed by a space, and then enter either Y or N. If Y is entered, the home routing code specified in the tuple is included in the billing record. If N is entered, the home routing code is not included in billing records.

XLASEL = IAC

If the entry in subfield XLASEL is IAC, datafill the following refinements.

Field descriptions for conditional datafill

Field	Subfield	Entry	Explanation and action
	OPT	see subfield	Options. This field is a vector list consisting of up to ten options. Each option consists of subfield OSEL, and refinements that depend on the entry in subfield OSEL. The entry is concluded by a \$ and datafill continues with field DFOP.
	OSEL	PF	Option selector. Enter PF, followed by a space, and datafill refinement PFDIGS if there are prefix digits in the digit stream.
	PFDIGS	0 to 24	Number of prefix digits. If the entry in subfield OSEL is PF, datafill this refinement. Enter the number of prefix digits. If prefix digits are identified in a previous table, this number is added to the existing value. Prefix digits are not used to index any further translation tables and are not outputted, but they remain stored in call detail records (CDR).

XLASEL = RTE

If the entry in subfield XLASEL is RTE, datafill the following refinements.

Table AMAXLAID must be datafilled prior to selecting option AMAXLAID in field OSEL.

ACCODE (continued)

If options CDNRTE and CPRTE are both present in one tuple in table xxCODE, call processing accesses routing tables in the following order: table CPCUXLA is accessed first. If no match is found, table CDNUXLA is accessed next.

If options SETCDN and CDNRTE are both present in one tuple in table xxCODE, call processing accesses table CDNUXLA first, before the SETCDN option sets the called number name (CDNNAME).

ACCODE (continued)

Conditional datafill for XLASEL = RTE is shown in the table below.

Field descriptions for conditional datafill (Sheet 1 of 15)

Field	Subfield or refinement	Entry	Explanation and action
	OPT	see subfield	Options. This field is a vector consisting of a maximum of ten options. Each option consists of subfield OSEL, and refinements that depend on the entry in subfield OSEL. For each option, specify the option selector (OSEL), followed by a space and the refinements, each separated by a space. The entry is concluded by a \$. Datafill continues with field DFOP.
	OSEL	ACF, AMAXLAID, BLKOVLP, CALLCTRL, CAMA, CATRTE, CDN, CDNRTE, CHGIND, CLASS, CONSUME, CPCRTE, CPMCALL, DDIDX, DEST, DFT, EXTCIC, IAA, LNET, MM, MZONE, NETSRV, NICRF, NOANSTIM, PCC, PF, PIP, PORTED, PNRF, PRESEL, PRESELRTE PRIVL, QFT, SETCDN, TELETAXE, TOC, VPN, or VPNPAN	Option selector. The following options can be selected: Enter ACF, followed by a space, and datafill refinement ACF if the area code fence is defined. Enter AMAXLAID, followed by a space, and datafill refinement XLAID to specify an automatic message accounting (AMA) identity from within table AMAXLAID. Enter BLKOVLP, followed by a space, and datafill refinement XLADATA, to prevent calls from being outpulsed until all CDN digits are collected. Enter CALLCTRL, followed by a space, and datafill refinement CALLCTRL. The entry in refinement CALLCTRL indicates who has control of the call: the calling party, the called party, or both.

ACCODE (continued)**Field descriptions for conditional datafill (Sheet 2 of 15)**

Field	Subfield or refinement	Entry	Explanation and action
			<p>Enter CAMA, followed by a space, and datafill refinement CLDFMT. The entry in refinement CLDFMT indicates whether the international centralized automatic message accounting (ICAMA) record is generated with either the originally signaled directory number (DN) or the final public switched telephone network (PSTN) number.</p> <p>Enter CATRTE to allow charge category routing in IBN translations.</p> <p>Enter CDN, followed by a space, and datafill refinement CDN to select the nature of address field. This field is used to identify the called party of the initial address message (IAM). It is used for Australian ISDN user part (AISUP) call translations.</p> <p>Enter CDNRTE to route using the called number name (CDNNAME) from table CDNCHAR. If the CDNNAME is present on the incoming call or is set by the SETCDN option, translation proceeds to table CDNUXLA. The CDNRTE option does not apply to table AMCODE.</p> <p>Enter CHGIND, followed by a space, and enter data for refinement CHGIND. This field indicates if the system applies a charge against the call.</p> <p>Enter CLASS, followed by a space, and datafill refinement CLASS if the class of the dialed digits is determined.</p> <p>Note: For the Japan market, if both the CLASS and IAA options are in use, IAA must precede CLASS in the datafill order.</p> <p>Enter CONSUME, followed by a space, and datafill refinement CONDIGS to specify the number of digits that are consumed during translation.</p>

ACCODE (continued)**Field descriptions for conditional datafill (Sheet 3 of 15)**

Field	Subfield or refinement	Entry	Explanation and action
			<p>Enter CPRTE to route using the calling party category (CPCNAME) from table CPCCHAR. If the CPCNAME is present on the incoming call, translation proceeds to table CPCUXLA. The CPRTE option does not apply to table AMCODE.</p> <p>Enter CPMCALL, followed by a space, and datafill refinement CPMCALL to specify call billing against the called party instead of the calling party for intraoffice calls.</p> <p>Enter DDIDX, followed by a space, and datafill refinement DDIDX if a destination discount applies.</p> <p>Enter DEST, followed by a space, and enter data for refinement DEST. Enter data for the field if the destination is known.</p> <p>Enter DFT for DPNSS feature transparency functionality. Operates in conjunction with the QFT option (see later). QFT must be ON.</p> <p>Enter EXTCIC, followed by a space, and datafill refinements SOURCE, SKIPDIGS, and CICSIZE. EXTCIC is the external carrier identification code that indicates a long distance carrier in the global environment. This option is only supported for TOPS calls. For further information, refer to functionality Global Competitive Access, GOS00006.</p> <p>Enter IAA and the datafill refinement IAA_INDEX to generate or modify IAA message parameters based on datafill in table IAACtrl.</p> <p>Note: For the Japan market, if both the IAA and CLASS options are in use, IAA must precede CLASS in the datafill order.</p> <p>Enter LNET, followed by a space, and datafill refinement LNET if a logical network is required for metering.</p>

ACCODE (continued)

Field descriptions for conditional datafill (Sheet 4 of 15)

Field	Subfield or refinement	Entry	Explanation and action
			<p>Enter MM, followed by a space, and datafill refinements MIN and MAX if the minimum and maximum number of expected digits dialed are known. These values include the digits used to index the current tuple and must also include the prefix digits specified in the current tuple.</p> <p>Note: For fast interdigital timing to function properly, MM can only be used with the RTE selector whenever the value in refinement MIN is not equal to the value in refinement MAX. In other words, if MIN=MAX, MM can be used with the CONT selector in table PXCORE; if the value in refinement MIN is not equal to the value in refinement MAX, MM cannot be used until the RTE selector is used (which is usually in either table FACODE or table OFCCODE). If refinements MIN and MAX are set in table PXCORE when they are not equal to each other, partial dial timing is used after MIN digits are dialed to determine the end of dialing.</p> <p>Enter MZONE, followed by a space, and datafill refinement MZONE if metering is done on the call.</p> <p>Enter NETSRV and datafill refinement NETSRV_NAME to indicate a Japan network service.</p> <p>Enter NICRF to activate the Network Identification Code (NIC) routing function.</p> <p>Enter NOANSTIM, to the RTE selectors. This turns the T9 timer off in the outgoing ISUP trunk, if encountered.</p> <p>Enter PCC, followed by a space, and datafill refinement PCCDR if a pseudo country code is required.</p>

ACCODE (continued)**Field descriptions for conditional datafill (Sheet 5 of 15)**

Field	Subfield or refinement	Entry	Explanation and action
			<p>Enter PF, followed by a space, and datafill refinement PFDIGS, the prefix fence. This is the number of prefix digits associated with this tuple (that is, if some prefix digits were identified in a previous table, the number here is added to the existing value). Prefix digits are not used to index any further translation tables and are not outpulsed, but they remain stored in call detail records (CDR).</p> <p>Enter PNRF to invoke the ported number recognition function. Datafill the PNRFOPTS options vector and associated subfields.</p> <p>Enter PIP, followed by a space, to perform a residency check for the digits being translated. The residency check is used by the local number portability feature to ensure that calls to DNs which have been ported in to the office are not routed out of the office.</p> <p>Note: You must complete entries in fields MIN and MAX before entering the PIP option.</p> <p>Enter PORTED to indicate that a previous node detected the service number of this call to have been ported.</p> <p>Enter PRESEL, followed by a space, if the call is to be treated as a preselected carrier case.</p> <p>Enter PRESELRTE, followed by a space, and datafill refinement PRESELRTE, the index into the route table of the current XLASYS and XLANAME.</p> <p>Enter PRIVL, followed by a space, and datafill refinement PRIVL if the user is a privileged user (for example, operators).</p>

ACCODE (continued)

Field descriptions for conditional datafill (Sheet 6 of 15)

Field	Subfield or refinement	Entry	Explanation and action
			<p>Enter QFT followed by ON or OFF to indicate if an outgoing route is capable of QSIG Feature Transparency.</p> <p>Note: The QFT ON option must not be added to a route unless the far-end node is QFT-capable.</p> <p>Enter SETCDN to trigger the setting of outgoing called party characteristics. This option assigns the called number name (CDNNAME) from table CDNCHAR to the call. If the CDNRTE option is subsequently encountered, the CDNNAME is used to route the call.</p> <p>You can use the SETCDN option to allow CDN routing when incoming agents such as DPNSS or BTUP are not available in table CDNCHAR.</p> <p>Enter TOC, followed by a space, and datafill refinement CHG for the type of charge where the type of charge messaging is to be selected.</p> <p>Enter VPN, followed by a space, and datafill refinements ONNET and BILLABLE if the call routes through a service switching point (SSP) and the Australian VPN-SSP feature is present on the switch.</p> <p>Enter VPNPAN to indicate that the PINX is to act as the PAN for an outgoing route.</p> <p>Note: If VPNREPL or VPNXLT have been entered in the DMOD selector, the VPNPAN option is ignored.</p>
	ACF	0 to 29	<p>Area code fence. If the entry in subfield OSEL is ACF, datafill this refinement. Enter the number of digits between the beginning of the digits to index the table, and the end of the area code.</p>

ACCODE (continued)**Field descriptions for conditional datafill (Sheet 7 of 15)**

Field	Subfield or refinement	Entry	Explanation and action
	BILLABLE	Y or N	<p>Virtual private network billable call. If the entry in subfield OSEL is VPN, enter Y if an automatic message accounting (AMA) record is required for each VPN call. Otherwise, enter N.</p> <p>An AMA record is not generated if an address complete message (ACM) of address complete, no charge is returned, or if the call terminates in the SSP on a line with the free number terminating (FNT) option.</p>
	CALLCLASS	PRESELECT OVERRIDE, CALLTYPE, CSN, TRUNK	<p>Call class. If the entry in subfield OSEL is PRESEL, enter PRESELECT to treat the DN as a preselected call. Enter OVERRIDE to permit the DN to use override codes. For charge category routing enter CALLTYPE. Enter CSN to treat the DN as a carrier specific number. Enter TRUNK to permit access to trunk originated calls. CALLCLASS does not apply to Global loads.</p>

ACCODE (continued)**Field descriptions for conditional datafill (Sheet 8 of 15)**

Field	Subfield or refinement	Entry	Explanation and action
	CALLCTRL	CALLED, CALLING, LAST, or MUTUAL	<p>Call control. If the entry in subfield OSEL is CALLCTRL, datafill this refinement. Enter one of the following values to specify the party controlling the call:</p> <ul style="list-style-type: none"> • If the entry is CALLED and the called line goes on-hook first, the call is released immediately. If the calling line goes on-hook first and does not reanswer, the connection is not released until the called line goes on-hook. There are no time-outs, and the calling party is allowed to reanswer until the called line goes on-hook. Calls to lines with option ESG must have CALLCTRL(CALLED). Calls terminating on an ITOPS position must have CALLCTRL(CALLED). • If the entry is CALLING and the calling line goes on-hook first, the call is released immediately. If the called line goes on-hook first, the called party is allowed to reanswer within a datafilled reanswer time-out or until the calling line goes on-hook. If the time-out expires or if the calling line goes on-hook, the calling party releases the call and the called line is set to idle. • If the entry is LAST, the call is released when the later of the called party or the calling party goes on-hook. If either party goes on-hook, that party is allowed to reanswer within a datafilled reanswer time-out or until both parties go on-hook. • If the entry is MUTUAL and either line goes on-hook, the call is released immediately.
	CATRTE	CATRTE	Enter CATRTE to allow charge category routing in IBN translations.
	CDNNAME	alphanumeric string	If the entry in subfield OSEL is SETCDN, enter data for the called number name (CDNNAME).

ACCODE (continued)**Field descriptions for conditional datafill (Sheet 9 of 15)**

Field	Subfield or refinement	Entry	Explanation and action
	CHG	SEND_ CHARGE or SEND_NO_ CHARGE	<p>Charge. If the entry in subfield OSEL is TOC, enter SEND_CHARGE to set the answer message (BTUP ANM) type of answer (TOA) string sent from a node to SEND_CHARGE.</p> <p>Enter SEND_NO_CHARGE to set the answer message (BTUP ANM) type of answer (TOA) string sent from a node to SEND_NO_CHARGE.</p>
	CHGIND	CHARGE or NO_CHARGE	If the entry in subfield OSEL is CHIND, enter data for refinement CHGIND. This refinement determines if the system applies a charge to the call.
	CICSIZE	1 to 4	<p>CIC size. If the entry in subfield OSEL is EXTCIC, enter data for this refinement. This field indicates the number of digits in the CIC. This field operates on the B (called) number, so it is assumed that the CIC is signaled as part of the B number.</p> <p>The MAP display indicates the range is 0 to 4; however, the system does not allow 0.</p>
	CLDFMT	CURRENT or POSTXLA	<p>Called format. If the entry in subfield OSEL is CAMA, enter either CURRENT or POSTXLA to produce the required ICAMA record format.</p> <p>If the entry is CURRENT, an ICAMA record is produced with the signaled DN (without translation).</p> <p>If the entry is POSTXLA, an ICAMA record is produced with a PSTN number resulting from translations.</p>

ACCODE (continued)**Field descriptions for conditional datafill (Sheet 10 of 15)**

Field	Subfield or refinement	Entry	Explanation and action
	CLASS	ATT, CNTL, COLL, DATT, EMRG, IAGRP, ICNTL, INTL, IOPRA, LCL, NATL, OPRA, RURAL, SPEC, UNKW, or URBAN	<p>Translation class. If the entry in subfield OSEL is CLASS, enter the translation class determined by the dialed digits. This can be used for screening or billing as described under CLASS in screening and charging options.</p> <p>The translation classes are defined as follows:</p> <ul style="list-style-type: none"> • ATT (attendant console) • CNTL (continental) • COLL (collect) • DATT (dial attendant) • EMRG (emergency) • IAGRP (interagent group) • ICNTL (intercontinental) • INTL (international) • IOPRA (international operator assisted) • LCL (local) • NATL (national) • OPRA (operator assisted) • RURAL (rural) • SPEC (special) • UNKW (unknown) • URBAN (urban)
	CONDIGS	numeric (0 to 29 digits)	Consumed digits. If the entry in subfield OSEL is CONSUME, datafill this refinement. Enter a number to explicitly define the number of digits consumed during call processing.
	CONTINUE	CONT or NOCONT	Continue. If the entry in subfield OSEL is PRESEL, enter CONT to continue translations through universal translations. Enter NOCONT to immediately route translations through PCIXLA or PCITRK.

ACCODE (continued)**Field descriptions for conditional datafill (Sheet 11 of 15)**

Field	Subfield or refinement	Entry	Explanation and action
	CPMCALL	Y or N	Called party metering. If the entry in subfield OSEL is CPMCALL, enter Y (yes) if calls are billed against the called party for intraoffice calls. Enter N (no) for the default value of billing against the calling party for intraoffice calls.
	DDIDX	1 to 63 or DEFAULT	Destination discount index. If the entry in subfield OSEL is DDIDX, datafill this refinement. Enter the destination discount index number, which is an index into table ACOOPT.
	DEST	0 to 1023	Destination route list index. If the entry in subfield OSEL is DEST, enter the number in the route list of the translation system that the call is routed to.
	IAA_INDEX	0 to 1024	Interadministration accounting index. If the entry in subfield OSEL is IAA, datafill this refinement. Enter the value that indexes the corresponding tuple in table IAACRRL.
	LNET	alphanumeric (1 to 8 characters)	Logical network. If the entry in subfield OSEL is LNET, enter the logical network name that the call is on. The logical network name must be previously datafilled in table LNETWORK. The entry in this field is used by the international metering system to determine a tariff for the call.
	MAX	0 to 30	Maximum digits. If the entry in subfield OSEL is MM, datafill this refinement. Enter the maximum number of digits expected. This value includes the digits used to index the current tuple and must also include the prefix digits specified in the current tuple.
	MIN	0 to 30	Minimum digits. If the entry in subfield OSEL is MM, datafill this refinement. Enter the minimum number of digits expected. This value includes the digits used to index the current tuple and must also include the prefix digits specified in the current tuple.

ACCODE (continued)**Field descriptions for conditional datafill (Sheet 12 of 15)**

Field	Subfield or refinement	Entry	Explanation and action
	MZONE	0 to 63	Metering zone. If the entry in subfield OSEL is MZONE, datafill this refinement. Enter the metering zone of the call, in the logical network as defined by selector LNET. The entry in this field is an index (DESTZONE) in table MDESTIDX.
	NETSRV_NAME	IPHS, DPHS, MOBILE, DA, TELEGRAM, or NCC	<p>Network service name. If the entry in subfield OSEL is NETSRV, datafill this refinement. The entry in this field determines the parameters in an outgoing IAM message.</p> <p>Enter IPHS to indicate a call to an independent personal handyphone system subscriber.</p> <p>Enter DPHS to indicate a call to a dependent personal handyphone system subscriber.</p> <p>Enter MOBILE to indicate a call to a mobile subscriber.</p> <p>Enter DA to indicate a call to the directory assistance operator.</p> <p>Enter TELEGRAM to indicate a call to the Telegram office.</p> <p>Enter NCC to indicate a call routed to one of the following networks:</p> <ul style="list-style-type: none"> • New Common Carrier serving international toll traffic • New Common Carrier serving national toll traffic
	NICRF	NICRF	NIC routing function. This option allows transit calls prefixed with the NIC to access table PNINFO to route the call based on the NIC. Note that the NICRF and PNRF options are incompatible and cannot be datafilled on the same tuple.

ACCODE (continued)**Field descriptions for conditional datafill (Sheet 13 of 15)**

Field	Subfield or refinement	Entry	Explanation and action
	NOA	INTL, LOCAL, NATL, or NET	<p>Nature of address. Enter the required called party nature of address:</p> <ul style="list-style-type: none"> • INTL (international) • LOCAL (local) • NATL (national) • NET (Intelligent Network Services)
	ONNET	Y or N	<p>Call on virtual private network. If the entry in subfield OSEL is VPN, enter Y if the call stays within the defined virtual private network. Otherwise, enter N.</p> <p>Overlapped outpulsing is supported only on off-network calls. Calls processed without subfield ONNET set to Y are off-network calls. Meridian Digital Centrex (MDC) calls are treated as off-network calls, and therefore overlapped outpulsing is supported for MDC calls.</p>
	PCCDR	0 to 9, B, C, D, E (1 to 3 digits)	<p>Pseudo country code digits. If the entry in subfield OSEL is PCC, enter the three-digit pseudo country code (PCC). If a two-digit PCC is required, it must be padded by a leading zero.</p> <p>The pseudo country code is used to record a particular pseudo country code. This can be extracted for use by system logic later, for example, two-stage outpulsing.</p>

ACCODE (continued)

Field descriptions for conditional datafill (Sheet 14 of 15)

Field	Subfield or refinement	Entry	Explanation and action
	PFDIGS	0 to 24	<p>Number of prefix digits. If the entry in subfield OSEL is PF, datafill this refinement. Enter the number of prefix digits. If prefix digits are identified in a previous table, this number is added to the existing value. Prefix digits are not used to index any further translation tables and are not outpulsed, but they remain stored in call detail records (CDR).</p> <p>Note: If refinements PF and CONSUME are both datafilled for the same tuple, the entry for the greater of the two values is processed; the other entry is ignored.</p>
	PFXAMA	0 to 4 digits or N	<p>Called party number prefix in AMA. If NOA is set to NTL, datafill PFXAMA with 0011.</p> <p>If NOA is set to NATL, datafill PFXAMA with 0.</p> <p>If NOA is set to LOCAL or NET, datafill PFXAMA with N.</p>
	PORTED	PORTED or blank	<p>Number portability indicator. This entry indicates that the service number for this call has been ported.</p>
	PNRF	PNRFOPTS	<p>Ported number recognitions function. Datafill the PNRFOPTS options vector and the INSNG subfields:</p>
	INSNG	See subfields PREFIX and TRUNK_ACCESS_DIGS	
	PREFIX	0 to 11	<p>PREFIX indicates the number of leading digits to be copied from an originator's DN and prefixed to the translating number.</p>
	TRUNK_ACCESS_DIG	0 to 9, or N	<p>TRUNK_ACCESS_DIG enables the specification of a trunk access digit to be prefixed to the translating number after the INSNG_PREFIX function has been completed.</p>

ACCODE (continued)**Field descriptions for conditional datafill (Sheet 15 of 15)**

Field	Subfield or refinement	Entry	Explanation and action
	PRIVL	Y or N	Privileged user. If the entry in subfield OSEL is PRIVL, enter Y (yes), if the user is a privileged user (for example, operator). Otherwise, enter N (no).
	SKIPDIGS	0 to 24	Skip digits. If the entry in subfield OSEL is EXTCIC, datafill this refinement. This field indicates the number of digits to skip before extracting the carrier digits from the digit stream. This field operates on the B (called) number, so it is assumed that the CIC is signaled as part of the B number.
	SOURCE	PRESUB or DIALED	Carrier identification code source. If the entry in subfield OSEL is EXTCIC, datafill this refinement. This field specifies the source of the CIC as follows: <ul style="list-style-type: none"> • PRESUB—presubscribed, the CIC is defined in table TRKGRP • DIALED—dialed, the CIC is entered by the subscriber when dialing a call
	STOPRTMR	Y or N	Stop remote timer. Enter Y (yes) to disable the address complete message (ACM) timer of the remote switch. The default value is N (no).
	XLAID	FREE, GENERIC1, GENERIC2, GENERIC3	AMA translation identifier. If the entry in subfield OSEL is AMAXLAID, enter the AMA translation identifier to be used against table AMAXLAID.

XLASEL = TRMT

If the entry in subfield XLASEL is TRMT, datafill the following refinements.

ACCODE (continued)

Route to the specified treatment. A treatment is a known exception or failure condition. The action taken terminates translation, returning an indication that a treatment was encountered and decoded into a route.

Field descriptions for conditional datafill

Field	Subfield or refinement	Entry	Explanation and action
	OPT	see subfield	Options. This field is a vector consisting of up to ten options. Each option consists of subfield OSEL, and refinements that depend on the entry in subfield OSEL. For each option, specify the option selector (OSEL), followed by a space, and the refinements, each separated by a space. The entry is concluded by a \$ and datafill continues with field DFOP.
	OSEL	OFC	Option selector. Enter OFC, followed by a space, and datafill refinement OFC, if a treatment name is required.
	OFC	alphanumeric (1 to 4 characters)	Office treatment. Enter a treatment name that is contained in the office treatment subtable, TMTCNTL.TREAT.

Datafill example

The following example shows sample datafill for table ACCODE.

For more detailed information, refer to examples in the description of table ACHEAD.

MAP display example for table ACCODE

XLANAME	FROMD	TOD
XLADATA		
<hr/>		
FTRXLA	C89	C89
DMOD (DEL3)	(INSRT CC)	(XLT AC FTRXLA) \$
FTRXLA	154	154
DMOD (DEL3)	(INSRT B54B)	(XLT AC FTRXLA) \$

ACCODE (continued)

Table history**MMP14**

Added option DFT to selectors CONT and RTE.

Added options FOC and FDT to selector FTR.

Added option CALLDUR to selector CONT.

MMP13

Increased table size from 16 384 to 32 768 tuples.

Added options PORTED, NICRF and, suboption INSNNG (to PNRF) to selectors CONT and RTE.

Added CATRTE option within OSEL under CONT, DMOD, and RTE selectors.

Added CALLTYPE option under PRESEL.

MMP12

Added option NOANSTIM to selectors CONT and RTE.

EUR010

Added option CPCRTE to selectors CONT, DMOD, and RTE.

LET010

Added option EXTCIC to selectors CONT, DMOD, and RTE.

APC010

Added option DA to subfield NETSRV_NAME.

Added field TLC_CHARGE to option TLC in the FEATINFO selector.

APC009.1

Added option VMWI to subfield FTR. Added subfields STATUS, VMDN, and PFDIG for option VMWI.

Added station ringer test (SRT) information to FTR section of selector FEAT.

APC009

Added option NETSRV to selectors CONT and RTE.

Added option JES to selector FEATINFO.

ACCODE (continued)

EUR009

Added option BLKOVLP to selector RTE and option PNRF to selectors CONT and RTE.

EUR008

Added CDNRTE, SETCDN, VPNREPL, and VPNXLT options to the DMOD selector.

Added CDNRTE, QFT ON, QFT OFF, SETCDN, and VPNPAN options to the CONT and RTE selectors.

Added HRC selector and PIP option to the RTE selector.

APC008.1

Field CHKCCR was added to all subscriber types (SUBSCTYP) that are part of the SUBSCRN option of selector FEATINFO VALIDATE.

Field EARLYCPG was added to selector FEATINFO.

Option IAA was added to selectors RTE and CONT.

APC008

The following changes were made in APC008:

- option TRUNK was added to field CALLCLASS of option PRESEL for selectors CONT and RTE
- option PRESEL was added to field VALDATOP in selector FEATINFO
- option CLIOVRD was added to selector CONT subfield OSEL

APC007

Added option PRESEL to selectors CONT and RTE.

APC006

Subscriber type PERSONAL was added to option SUBSCRN of FEATINFO VALIDATE.

GL03

The following updates were introduced in GL03:

- added ACF in RTE and CONT selectors
- added CAMA in RTE, CONT, and DNRTE selectors
- added URBAN to selector CLASS

ACCODE (continued)

NA005

The following updates were introduced in NA005:

- Increased universal translations support to 30 digits, affecting the following options, subfields, and selectors:
 - ACF
 - AFTER
 - CONSUME
 - DEL
 - DMOD
 - DNRTE
 - INSRT
 - MAX
 - MIN
 - PF
 - REPL
- Added option SF and refinement SFDIGS to selector DNRTE.
- Added note about potential conflict with refinements CONSUME and PFDIGS.

APC004

Features CALLBACK, CALLCHAR, CLCTDIGS, NTC, and TLC were added to the FTR field of selector FEATINFO.

Options CLDTCCLG, LCASCRN, TCNOTSCR, VERDEST, and V3PTYBIL were added to the VALDATOP subfield of selector FEATINFO.

Subfield CDN of selectors CONT and RTE was modified to incorporate subfields NOA, STOPRTMR, and PFXAMA.

UK002

Option OSS was added to subfield OSEL for selectors CONT and RTE.

BCS36

Option CUSTMOD was added to refinement VALDATOP for XLASEL FEATINFO. Range of field PCCDR changed for selectors CONT and RTE.

ACCODE (end)

BCS35

The following changes were made:

- CGNDM was added to option selector OSEL and refinements.
- Fields PRDFXCLI, INSERTCLI, and CONSUME were added.
- BCSCRN was added to field VALDATOP.
- CPMCALL was added to XLASEL values CONT and RTE.
- Added restrictions on use of VALIDATE.

ACGDUR**Table name**

Automatic Call Gap Duration (ACGDUR) table

Functional description

Table ACGDUR provides the ability to provision specific time periods against automatic call gap (ACG) parameter duration values received in a TCAP response message. This table allows a range of 1-32767 10ms time increments to be provisioned against a particular ACG duration value received in the TCAP ACG parameter.

The ACGDUR table is indexed when the switch receives an N00 TCAP response message, and an ACG parameter is contained within a network management component. This table is used to retrieve a time duration value corresponding to the duration value.

This table is indexed by a two-part key consisting of the duration mode and duration index value from the ACG parameter. The entry retrieved contains a time duration indication. This time duration value is used for the ACG control functionality.

Memory requirements

Table ACGDUR memory requirements are 512 words or 1024 bytes.

Field descriptions

The following table describes field names, subfield names, and valid data ranges for table ACGDUR.

(Sheet 1 of 2)

Field	Subfield or refinement	Entry	Explanation and action
ACGDUR_KEY		see subfields	AUTOMATIC CALL GAP DURATION KEY. Datafill the two-part key consisting of: ACG_MODE and ACG_DURATION.
	ACG_MODE	BELLCORE, ANSI	ACG MODE. Enter the ACG mode. This value is determined by the ACG parameter identifier.
	ACG_DURATION	0 to 255	ACG DURATION INDEX. Enter the ACG duration. This is the value returned in the duration field of the ACG parameter.

ACGDUR (continued)

(Sheet 2 of 2)

Field	Subfield or refinement	Entry	Explanation and action
DURATION		see subfield	DURATION. Datafill the DURATIONVAL subfield.
	DURATION-VAL		<p>DURATION VALUE. This subfield identifies if the duration is infinite or based on the length identified by the TIMER field.</p> <ul style="list-style-type: none"> • INFINITE. Identifies that the ACG control is applied for an unspecified amount of time. • TIMER. Identifies that the ACG control is applied for the amount of time identified by the TIMER field. See section DURATIONVAL=TIMER for refinement datafill.

DURATIONVAL=TIMER

When DURATIONVAL=TIMER, datafill the following:

Field	Subfield or refinement	Entry	Explanation and action
TIMER		1 to 2048	TIMER. When the DURATIONVAL subfield is set to TIMER, this refinement displays. It identifies the duration time value in seconds. The duration value is used for ACG control.

Datafill example

The following example shows datafill for table ADGDUR.

ACGDUR_KEY	DURATION
ANSI 5	TIMER 512
BELLCORE 2	TIMER 8

Table history

UCS05

Table ACGDUR is created.

ACGDUR (end)

ACGGAP

Table name

Automatic Call Gap Value (ACGGAP) table

Functional description

Table ACGGAP provides the ability to provision specific time periods against automatic call gap (ACG) parameter gap values received in a TCAP response message. This table allows a time duration to be provisioned against a particular ACG value received in the TCAP ACG parameter. The table allows a range of 1-32767 10ms time increments to be provisioned against a particular ACG gap value received in the TCAP ACG parameter.

The switch indexes table ACGGAP when it receives an N00 TCAP response message containing an ACG parameter within a network management component. The switch retrieves from table ACGGAP a time duration value that corresponds to the gap value.

The table is indexed by a two-part key consisting of the gap mode and gap index value from the ACG parameter. The entry retrieved contains a time duration indication. This time duration value is used for the ACG control function.

Memory requirements

Table ACGGAP requires 1024 words, or 2048 bytes.

Field descriptions

The following table describes field names, subfield names, and valid data ranges for table ACGGAP.

(Sheet 1 of 2)

Field	Subfield or refinement	Entry	Explanation and action
ACGGAP_KEY		see subfields	AUTOMATIC CALL GAP VALUE KEY. Datafill the two-part key consisting of: ACG_MODE and ACG_GAP.
	ACG_MODE	BELLCORE, ANSI	ACG MODE. Used to determine the ACG parameter identifier.

ACGGAP (continued)

(Sheet 2 of 2)

Field	Subfield or refinement	Entry	Explanation and action
GAP	ACG_GAP	0 to 255	GAP INDEX. This is the value returned in the gap field of the ACG parameter.
		see subfield	GAP. This field contains one subfield: GAPVAL.
	GAPVAL	REMOVEGAP STOPALL- CALLS TIMER	<p>GAP VALUE. Identifies if the gap is being removed, infinite, or based on the length identified by the TIMER field.</p> <ul style="list-style-type: none"> • REMOVEGAP. Identifies that the ACG control is to be removed. • STOPALLCALLS. Identifies that ACG control should block all calls (infinite). • TIMER. Identifies that the ACG control in place allows a query to be sent to the SCP each instance the period of time identified by the TIMER field expires. See section GAPVAL=TIMER for refinement datafill.

ACGGAP (end)

GAPVAL=TIMER

When GAPVAL=TIMER, datafill the following refinement:

Field	Subfield or refinement	Entry	Explanation and action
TIMER		1 to 32767	TIMER. When the GAPVAL subfield is set to TIMER, this refinement displays. It identifies the gap time duration value in 10-millisecond increments. This time duration value is used for ACG control.

Datafill example

The following example shows datafill for table ACGGAP.

ACGGAP_KEY	DURATION
ANSI 5	TIMER 50
BELLCORE 6	TIMER 200

Table history UCS05

Table ACGGAP is created.

ACGMAP

Table name

Automatic Call Gap Map(ACGMAP) table

Functional description

Table ACGMAP provides the ability to map an ACG Control Cause Indicator (CCI) value to a treatment that will be used in the future.

The table is indexed by a one-part key, ACGMAP_KEY.

ACGMAP (continued)

Field descriptions

The following table describes field names, subfield names, and valid data ranges for table ACGMAP.

ACGMAP (continued)

Field	Subfield or refinement	Entry	Explanation and action
ACGMAP _KEY		01-FF	AUTOMATIC CALL GAP VALUE KEY. Datafill the treatment.
TRTMT		UNDT,NOSC,PDIL,PSIG,INAC,CNDT,VACT,M SCA,MSLC,NBLH,NBLN,EMR1,EMR2,UNCA ,SYFL,CQOV,HNPI,UNDN,BLDN,BUSY,UNO W,TDND,UNIN,SSTO,NCRT,RODR,MANL,OR SS,TESS,OPRT,TRBL,ANCT,PNOH,DNTR,NE CG,FECG,ORMC,TOVD,CONF,RRPA,ORAF,T RRF,ORAC,ORMF,SRRR,DISC,UNPR,BLPR,E MR3,EMR4,NOCN,PMPT,SORD,INAU,TINV,C NOT,DCFC,PRSC,GNCT,ATBS,MHLD,DODT, TDBR,RSDT,PTOF,VACS,ANTO,NMZN,FINAL ,UMOB,ERDS,STOB,STOC,EMR5,EMR6,INO C,ANIA,CFWV,NACK,CACE,D950,N950,ILRS, NACD,DACD,ADBF,PGTO,AIFL,FDNZ,CCTO, CCNV,CCNA,FDER,NOSR,CGRO,VCCT,LCA B,INCC,CONP,NINT,SCFL,NCIX,NCII,NCTF, NONT,NCUN,ATDT,ANBB,IVCC,SCUN,INPD ,NPAR,IDPB,CNAC,CBTN,MTOC,ANFL,CHA N,CHAF,OSVR,N00B,CFOV,ILRR,COSX,CAC B,SINT,IWUC,INBT,NC8F,FRDR,C7AP,DFTL, BBFS,NTRS,CREJ,UPAB,SORE,CNAD,VPFX, CCAP,ACPR,CCIR,ADPA,CCDT,UCCN,CBDN ,N9DF,N9OB,N9NS,CCCF,SCRJ,ICNF,LECV,L CNV,CGFL,VPFL,PTFL,SCA,NCS0,NCS1,CH NF,BCNI,RING,JACK,ITCF,NVIP,ACRJ,FCNI, PERR,INVM,SONI,CDAS,CDAF,CDDS,CDDF, AARD,DSCN,GFNV,LBSY,TBSY,IIEC,NOBC, NORA,PER1,PER2,PER3,PER4,PER5,CER1,W UCR,MTBL,MWKPRFCS,RFCD,RFCE,EROR, ERTR,ERTO,TRGB,ESNF,MBIA,Q33A,Q33B, AIND,AINF,INRF,RTTE,ITDN,PRTO,PAGE,CF WD,LDAA,LDAD,ORBT,AVPF,AVP2,BLMO,C CRG,CCRP,CCRM,CCRH,CCRT,MSOA,RTEE, PSNF,IRET,ISCN,IDST,DDPB,DRET,DDSN,D DST,ONPB,ORET,OSCN,ODST,ZMPB,ZMRT, ZPPB,ZPRT,MAUC,LNPM	TREATMEN T. Enter Treatment value to be used for CDR TRTMNT (EXTENDED TRTMNT type).

ACGMAP (end)

Dataview example

The following example shows dataview for table ACGMAP.

ACGMAP_KEY	TREATMENT
44	ADBF

Table history

UCS13

Table ACGMAP is created (A60008239).

ACHEAD**Table name**

Access Code Head Table

Overview

The table below lists all the universal translation tables. Throughout this document, "xxHEAD" represents one of the HEAD tables.

Universal translation tables (Sheet 1 of 2)

Table name	Form title	Table type
ACHEAD	Access Code	Head Table Record
AMHEAD	Ambiguous Code	Head Table Record
CTHEAD	Country Code	Head Table Record
FAHEAD	Foreign Area Code	Head Table Record
FTHEAD	Utility Code	Head Table Record
NSCHEAD	Number Service Code	Head Table Record
OFCHEAD	Office Code	Head Table Record
PXHEAD	Prefix Code	Head Table Record
ACCODE	Access Code	Code Table Record
AMCODE	Ambiguous Code	Code Table Record
CTCODE	Country Code	Code Table Record
FACODE	Foreign Area Code	Code Table Record
FTCODE	Utility Code	Code Table Record
NSCCODE	Number Service Code	Code Table Record
OFCCODE	Office Code	Code Table Record
PXCODE	Prefix Code	Code Table Record
ACRTE	Access Code	Route Table Record
CTRTE	Country Code	Route Table Record
FARTE	Foreign Area Code	Route Table Record
Note: There is no AMRTE table.		

ACHEAD (continued)**Universal translation tables (Sheet 2 of 2)**

Table name	Form title	Table type
FTRTE	Utility Code	Route Table Record
NSCRTE	Number Service Code	Route Table Record
OFCRTE	Office Code	Route Table Record
PXRTE	Prefix Code	Route Table Record
Note: There is no AMRTE table.		

Tables TOFCNAME and DNINV are also used for translating some segments of the incoming digit string and form an integral part of the universal digit translations scheme.

In international loads, the tables listed in table 1 and tables TOFCNAME, DNINV, and DNRTE replace the following tables:

- STDPRTCT
- HNPACONT
- FNPACONT
- CLSVSCRC
- LCASCRCN
- PFXTREAT
- THOUGRP
- WRDN
- DN

Table OFRT can be used in international loads for treatments and standard routes.

Universal translation tables functional overview

The DMS-100 switch uses the universal translation tables to translate the digit string after receiving the digits from the originator using the digit analysis tables DCHEAD and DCCODE.

The translation of incoming digits begins in the universal translation tables. The entry point into the translation tables is defined as XLASYS, the translation system, and XLANAME, the translation name. If a call originates in an international office, fields XLASYS and XLANAME of table

ACHEAD (continued)

LINEATTR (at the line attribute index applicable to the originating line) determine the point where translation of the received dialed digits begins. An originating incoming call on a trunk or group type, such as MTR or TPS101, is translated in the universal translation tables using fields XLASYS and XLANAME of table TRKGRP, if field XLASEL is set to UNIV in table TRKGRP or in table NETATTR. If field XLASEL is set to NETATTR in table TRKGRP using the table NETATTR tuple index specified in table TRKGRP, this index, field NETINDX, determines the point where translation of the received digits begins.

The results of the digit translation in the universal translation tables are shown below.

- The call is routed to one of the following places:
 - a terminating subscriber line
 - an outgoing trunk group
 - another network
- The call fails to route and the applicable treatment code is determined. This results in the prescribed combination of announcements or tones, or both, being returned to the originator.
- Translation recognizes that the digits dialed are a specific function code of a specific feature and reacts accordingly.
- Modification or replacement of the received digit string occurs before outpulsing and call data recording.
- The parameters required for screening and charging are determined.

Universal translations flow diagram

An illustration of universal translations is shown in the following figure.

ACHEAD (continued)

Universal translations flow diagram

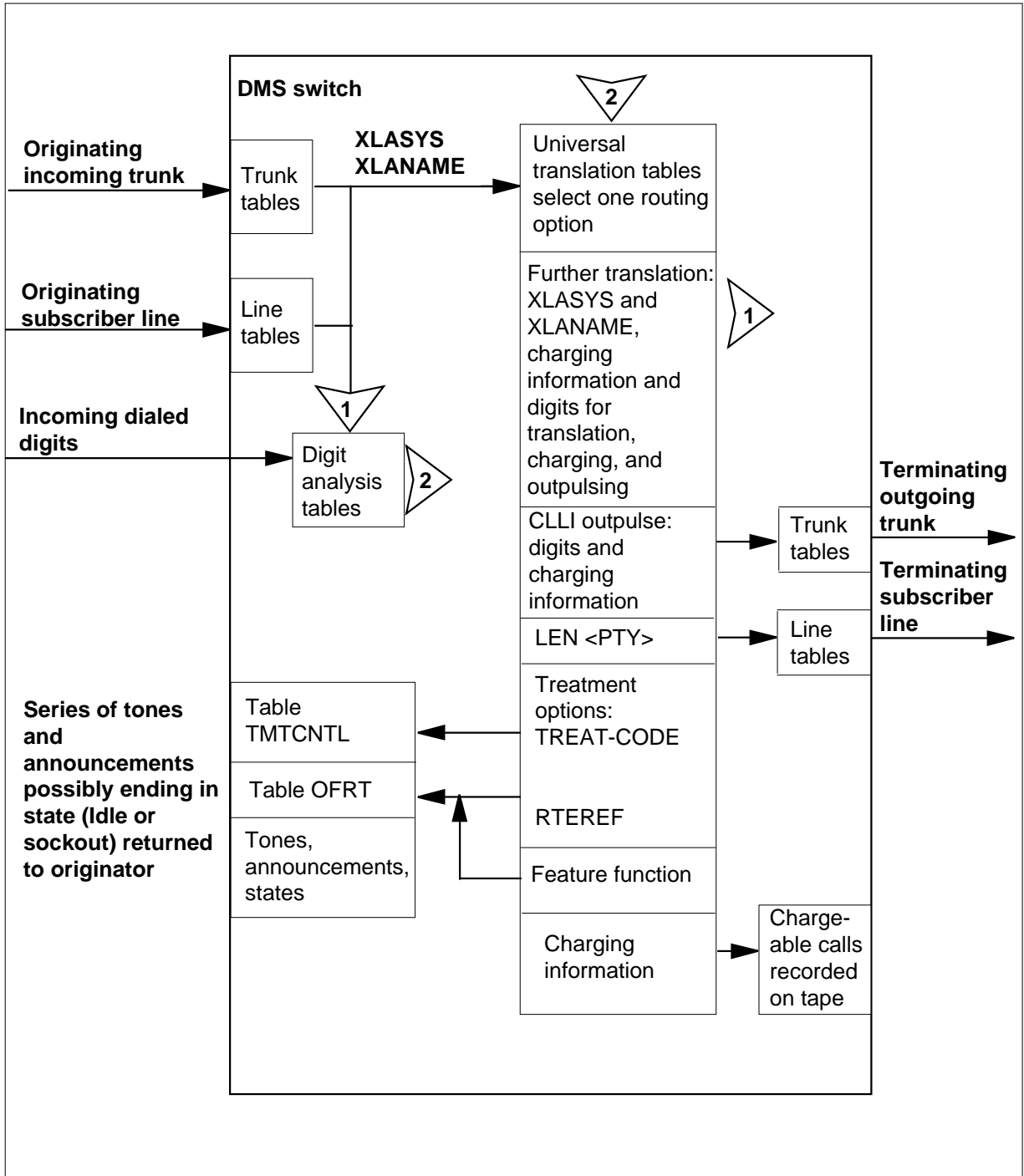

ACHEAD (continued)

Universal translation tables routing block diagram

A block diagram of the universal translation tables is shown in the following figure.

Universal translation tables routing block diagram

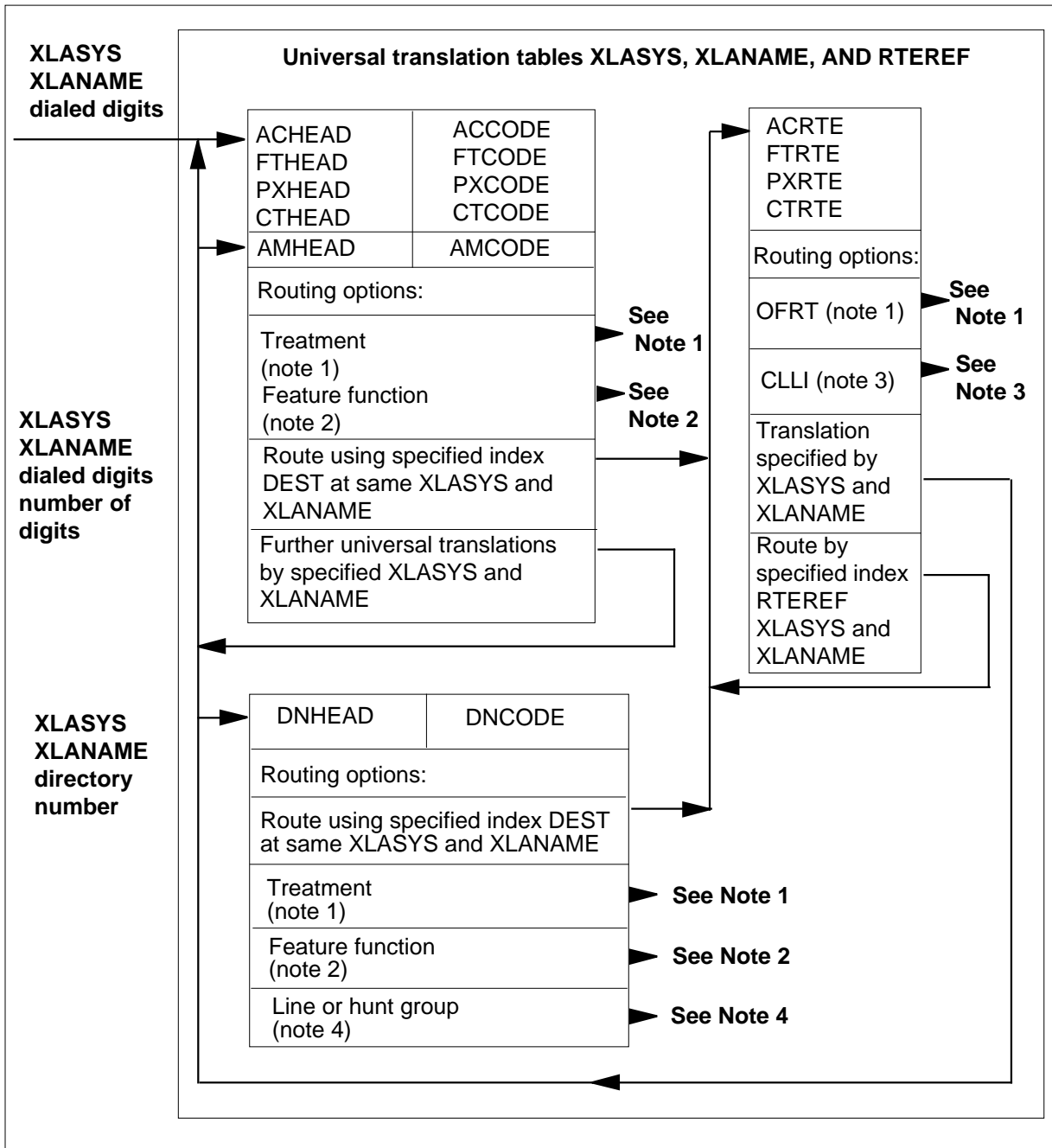

ACHEAD (continued)

Universal translation tables routing block diagram (continued)

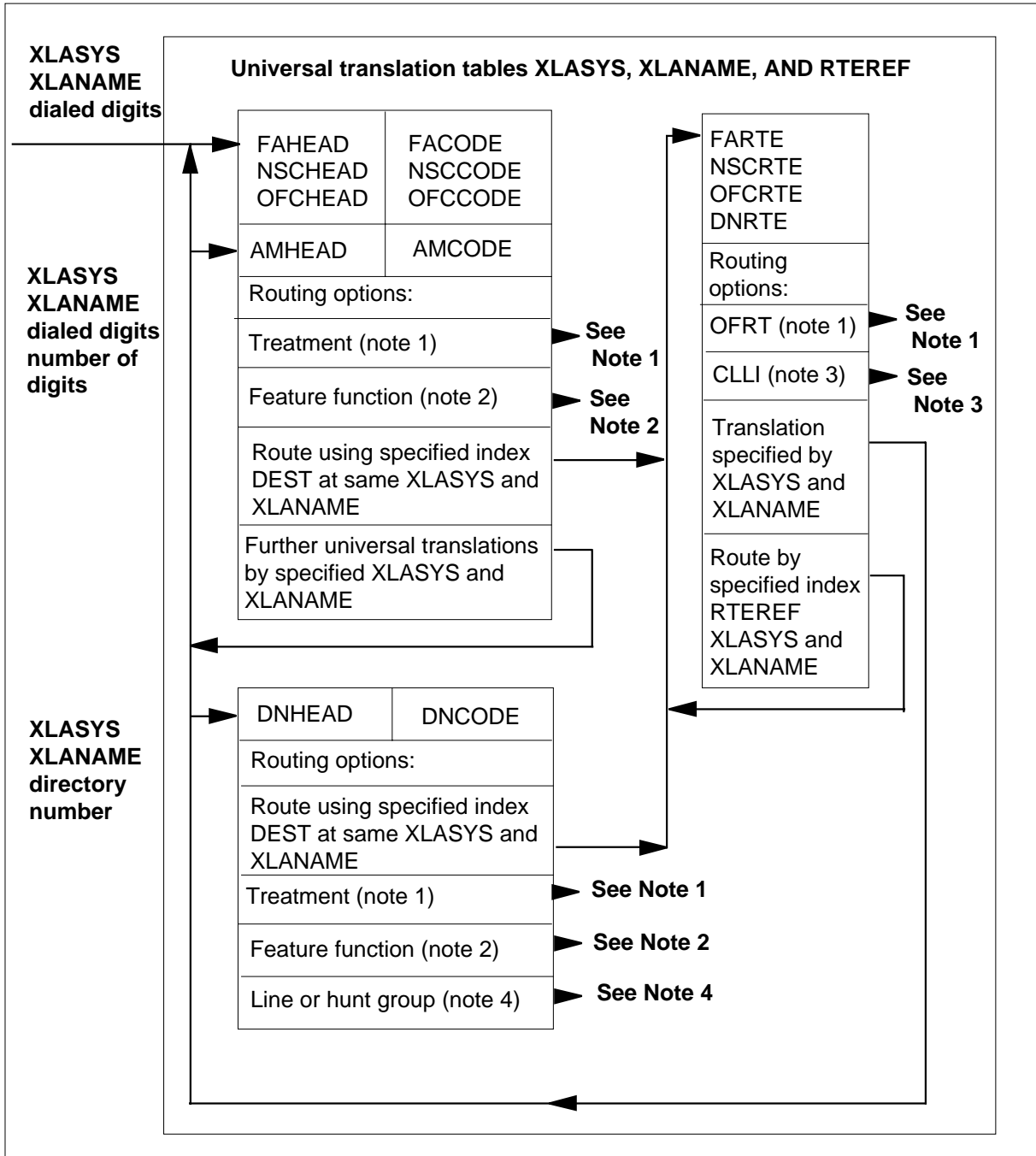

ACHEAD (continued)

Routing block diagram notes

Note 1: Translation results in one of the following indexes being returned to the originator of the call:

- a treatment code index into table TMTCNTL.TREAT leading to a tone, announcement, and state common language location identifier (CLLI)
- a route reference index into table OFRT for a series of tones, announcements, and state CLLIs

Note 2: The dialed digits are recognized as a function of a specific feature. DMS software then performs all associated functions related to the feature.

Note 3: The call is routed to an outgoing trunk group CLLI through trunk tables. Digits, or charging information, or both, can be outpulsed. Two-stage outpulsing can be specified.

Note 4: The call is routed to a line or hunt group through line or hunt group tables.

Translations flowchart for tables xxHEAD and xxCODE

An illustration of translations in tables xxHEAD and xxCODE with field XLASYS set to AC, AM, CT, FA, FT, NSC, OFC, and PX is shown in the following figure.

ACHEAD (continued)

Translations in tables xxHEAD and xxCODE

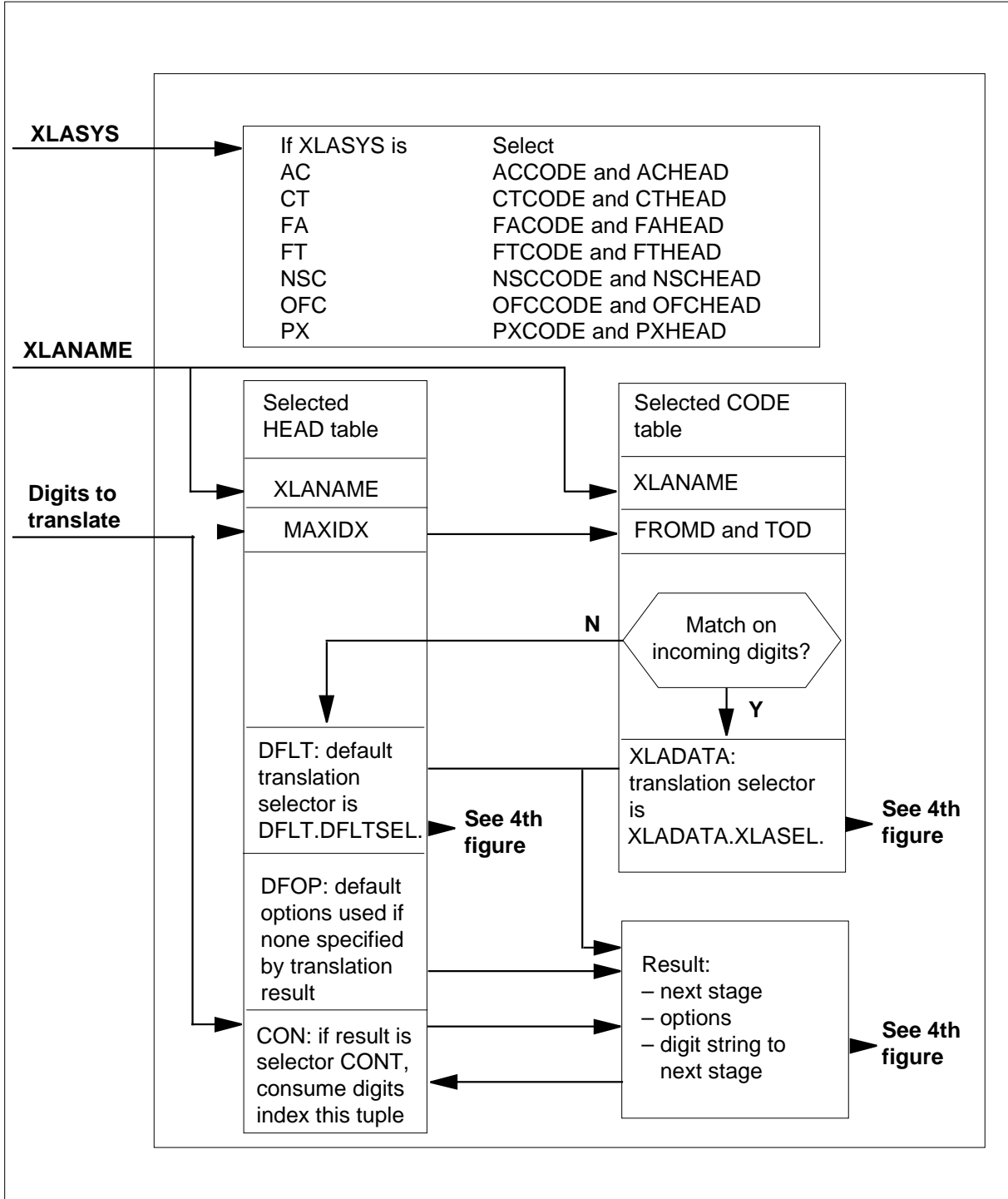

ACHEAD (continued)

Digit or default translations

An illustration of digit or default translations is shown in the following figure.

Digit or default translations

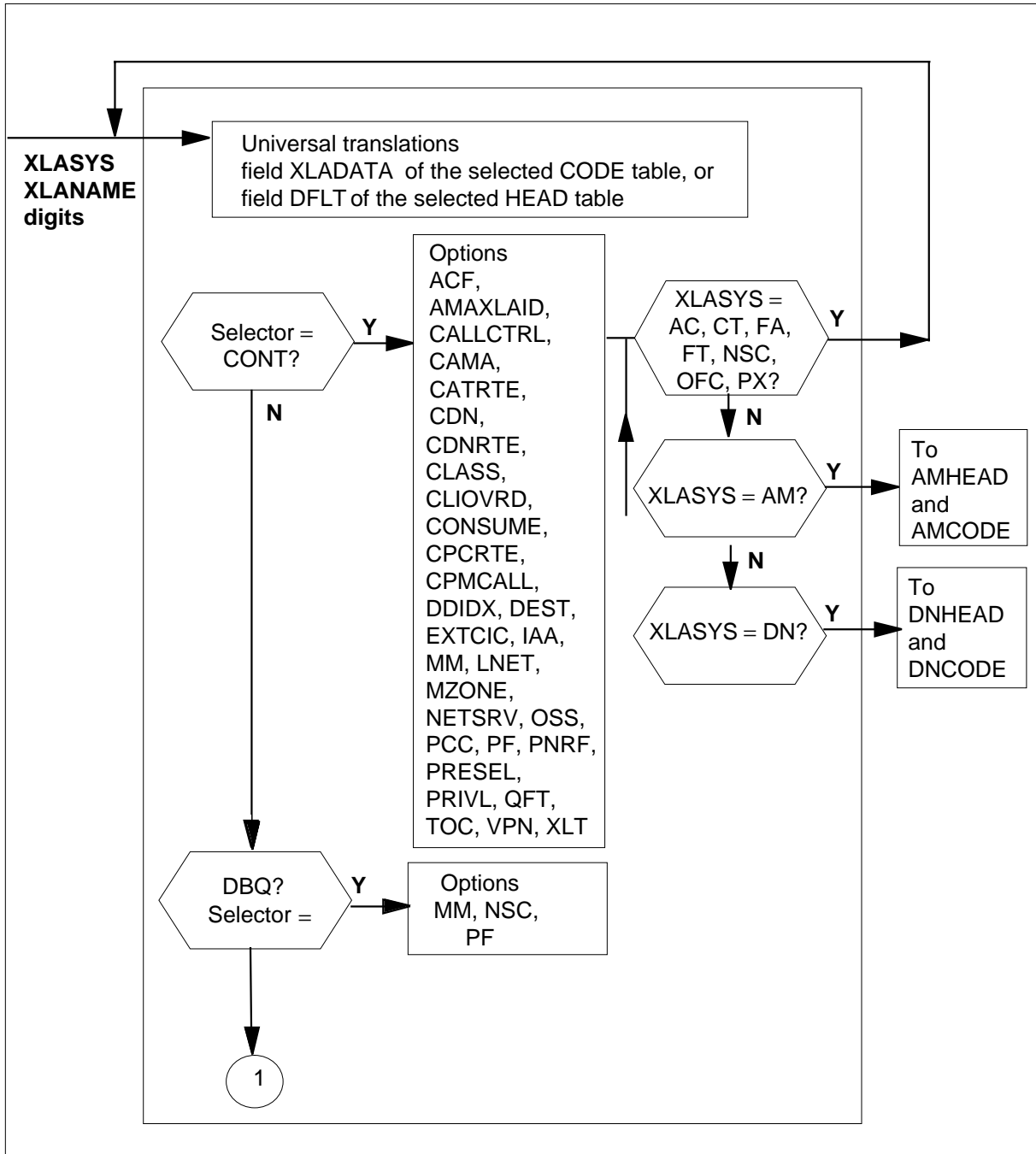

ACHEAD (continued)

Digit or default translations (cont'd)

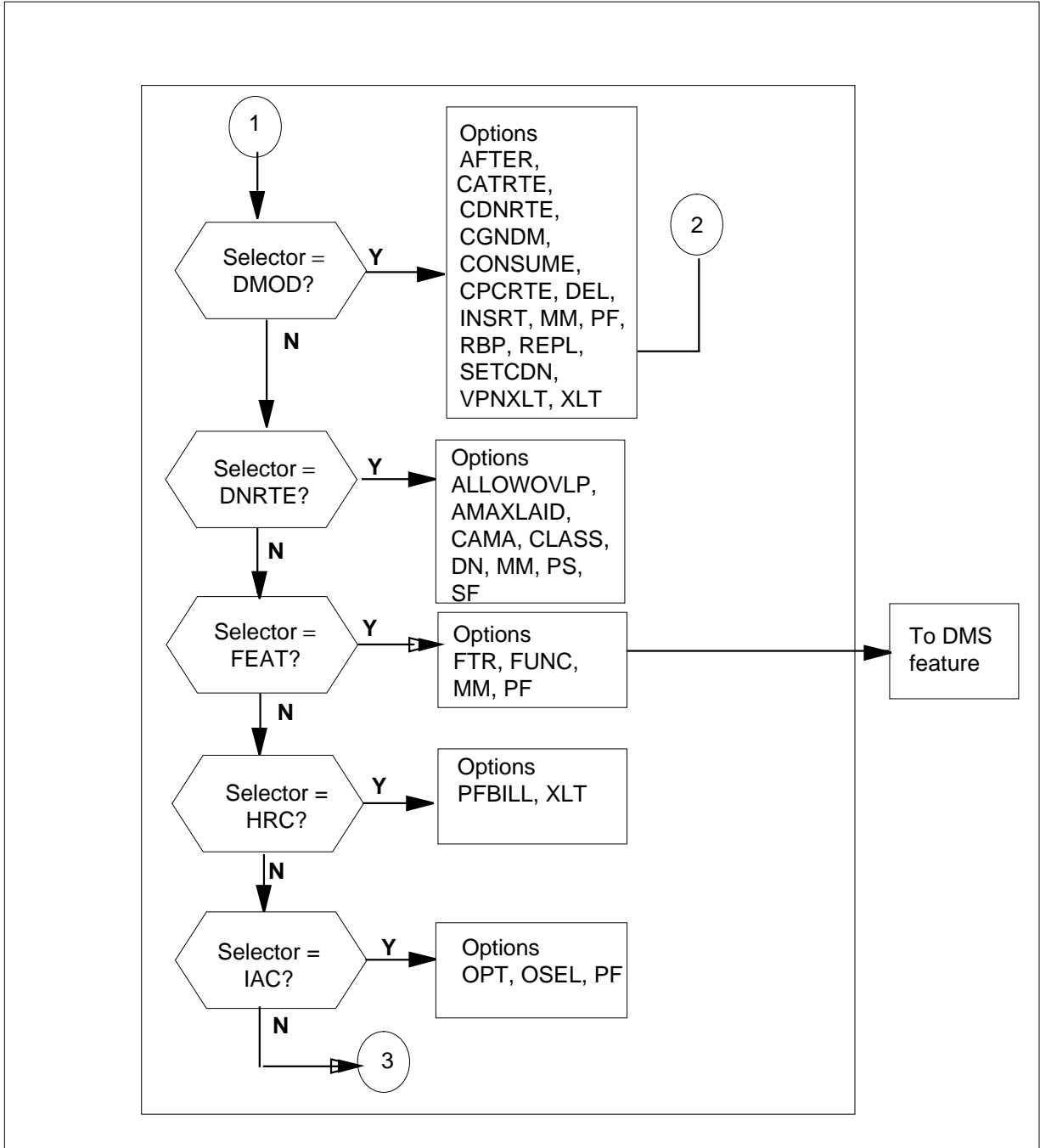

ACHEAD (continued)

Digit or default translations (cont'd)

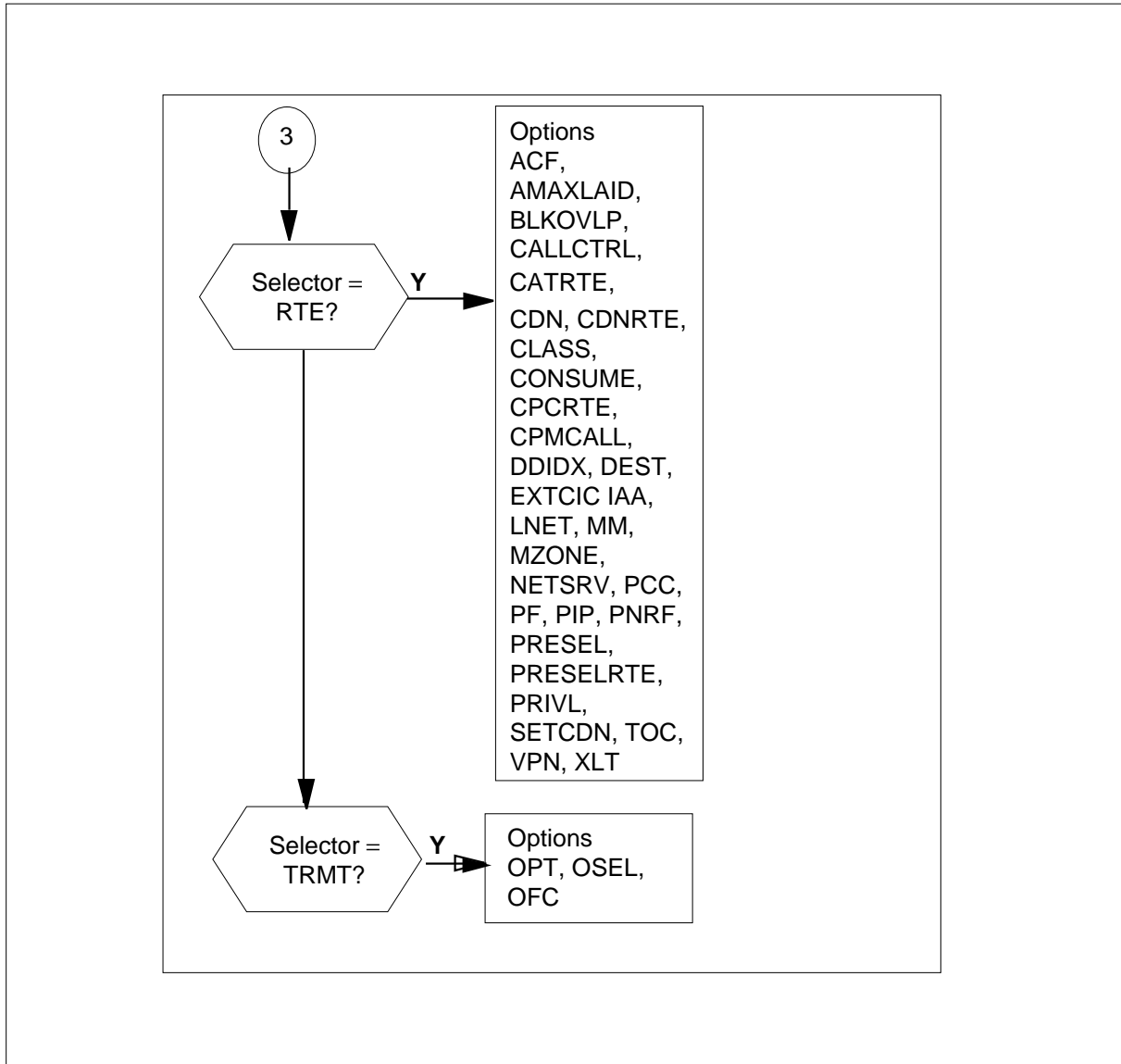

Universal translations options table

Before attempting to datafill translation tables, the following information must be available:

- office trunking diagram
- office dialing plan

A translation path must be provided for each possible dialed digit string by each of the potential originators (lines and trunks).

ACHEAD (continued)

In addition to routing the call to the desired destination, the following information must also be available:

- treatment
- feature function
- line or hunt group
- outgoing trunk group CLLI

The universal translation tables are used to define or modify

- the digits and charging parameters to outpulse, if any
- the calls that are chargeable and the value of the charge parameters

The incoming digit string is translated in the universal translation tables in functional digit segments. The translation of a digit segment can lead the translation path back into the universal translation tables for the translation of the next digit segment.

Each pass through the universal translation tables can modify some of the charging parameters and the digit strings used for outpulsing, charging, and translation. It is sometimes necessary to send the call for more translation in the universal translation tables to set the charging parameters to the required values and modify the various digit strings.

Translation of a digit segment involves the selection of a specific translation selector. Each translation selector groups a different set of charging parameters and digit string modifiers.

ACHEAD (continued)**Universal translations options**

The following table lists the options available for the universal translations tables xxHEAD and xxCODE. These tables do not have conditional options.

Universal translations options for xxHEAD and xxCODE tables (Sheet 1 of 2)

Functions and selectors		Digit string manipulation	Screening and charging	Proceed from: Proceed to:
CON		CON		
CONT	MM	CONSUME	ACF, AMAXLAID, CALLCTRL, CAMA, CATRTE, CLASS, IAA, LNET, MZONE, NETSRV, PF, PRESEL, QFT, VPNPAN	DEST to route table XLT to new translation system
DBQ	MM		NSC, PF	
DMOD		AFTER, CONSUME, DEL, INSRT, PF, REPL, VPNREPL, VPNXLT	CATRTE	XLT to new translation system
DN RTE	MM	PF, SF	AMAXLAID, CAMA, CLASS	DN to table TOFCNAME
FEAT				VSC to vertical service code tables
FEATINFO			CALLCHAR	VSC to vertical service code tables
HRC			PFBILL	XLT to new translation system
IAC			PF	
MAXIDX(field)	STD, 0-9, B, F			

ACHEAD (continued)

Universal translations options for xxHEAD and xxCODE tables (Sheet 2 of 2)

Functions and selectors	Digit string manipulation	Screening and charging	Proceed from: Proceed to:
RTE	MM	ACF, AMAXLAID, BLKOVLP, CALLCTRL, CAMA, CATRTE, CLASS, IAA, LNET, MZONE, NETSRV, PF, PRESEL, QFT, or VPNPAN	DEST to route table
TRMT			OFCto treatment

The following table lists the options available for the universal translations tables xxRTE. These tables do not have digit string checking or screening and charging functions.

Universal translations options for xxRTE tables

Functions and selectors	Digit string manipulation	Proceed from: Proceed to:	Conditional
CND			CNDSEL=TOD, NRR, or RNDRTETYPE=ST, SK, or T
N	DELETE, PFXDIGS, or PFXAFTER	CLLI to trunk group	
NOT			CNDSEL=NRR RTETYPE=ST, SK, or T
RT	RT_DIGITS	RX_LA_TAB to new translation system	
S		CLLI to trunk group	
T		EXTRTEID to new table	

ACHEAD (continued)**Universal translation tables internal overview**

The universal translation tables are organized to translate the incoming digit string in segments according to the order shown in the following table.

Digit string segment descriptions

Digit string segment descriptions	XLASYS	Tables
Access code digits	AC	ACHEAD, ACCODE
Utility code digits	FT	FTHEAD, FTCODE
Prefix code digits	PX	PXHEAD, PXCODE
Country code digits	CT	CTHEAD, CTCODE
Foreign area code digits	FA	FAHEAD, FACODE
Office code digits	OFC	OFCHEAD, OFCCODE
Number service code digits	NSC	NSCHEAD, NSCCODE
Ambiguous code	AM	AMHEAD, AMCODE

Note: The XLASYS translation stages described in this section (AC, AM, CT, FA, FT, NSC, OFC, PX) are identical in format and function. The mnemonic names and descriptive titles of each of the XLASYS translation stages in this section are only a guideline for the translation of a typical digit string. The software treats each of the XLASYS translation stages identically.

Universal translation stages for ambiguous codes (tables AMHEAD and AMCODE) and directory number (tables TOFCNAME and DNINV) are also used for translating some segments of the incoming digit string and form an integral part of the universal digit translations scheme.

A generalization of all numbering plans is shown below.

```

access code
+utility code
  +prefix code
    +country code
      +foreign area code
        +office code
          +number service code
            +station number

```

ACHEAD (continued)

Access code (XLASYS AC)

The access code is for access to another network, an attendant, or a feature. If a feature access code is dialed, the digits following do not correspond to the numbering plan. The access code of a network is usually required only when dialing into another network. For example, the user must dial an access code of 9 to access the local operating telephone company network from a private tie line network.

Utility Code (XLASYS FT)

The utility code is called from office parameters and is used to perform operations such as validation of an announcement or a call diversion destination.

Prefix code (XLASYS PX)

The prefix code gives information about the local operating telephone company type of call being dialed. For example, in North America there usually are prefix codes for domestic direct distance dialing (DDD), international DDD, domestic operator-handled calls, and international operator-handled calls. The default is usually not to dial the prefix code for a local call.

Country code (XLASYS CT)

Country codes are internationally agreed upon one-, two-, or three-digit numbers, beginning with the zone digit. Each country also has a pseudo country code, which is used for operator-handled traffic. All country codes are uniquely defined. The country code can be omitted if dialing a destination inside the same country (and sometimes if the destination is in an adjacent country).

Foreign area code (XLASYS FA)

An area code is assigned to an area of the country. In North America, area codes are distinguishable from office codes so that if the called number is within the same area as the calling number, the area code is not dialed. If it is dialed, it is ignored or blocked.

Office code (XLASYS OFC)

An office code is an exchange within the area.

Number service code (XLASYS NSC)

A number service code is for service switching point (SSP) applications that require access to a database.

ACHEAD (continued)**Ambiguous code (XLASYS AM)**

The ambiguous code universal translations tables are invoked when the total number of digits received in addition to the leading digits received determine which terminating route applies.

Universal translation of a digit segment

To translate each of the digit string segments, there are three universal translations tables:

- (XLASYS)HEAD table
- (XLASYS)CODE table
- (XLASYS)RTE table

For example, the universal translations tables used to translate the prefix code digits segment, translation system XLASYS PX, are PXHEAD, PXC CODE, and PXRTE.

In the universal translation tables described in this section

- each (XLASYS)HEAD table has identical syntax with other (XLASYS)HEAD tables
- each (XLASYS)CODE table has identical syntax with other (XLASYS)CODE tables
- each (XLASYS)RTE table has identical syntax with other (XLASYS)RTE tables

Universal translation tables digit string checking options

The initial time-out and interdigit time-out are defined in table DGHEAD and table DGCODE.

The following table shows the digit string presented for translation at each stage of universal translations described in this section.

Digit string checking options (Sheet 1 of 2)

Field	Refinements, values, and explanations
Option MM of selectors CONT, RTE, and DNRTE	<p>MIN (0 to 30) MAX (0 to 30) Minimum and maximum total number of digits expected</p> <p>Typical input: MM 7 10</p> <p>The call terminates in a treatment if the total number of digits received is less than the minimum number specified in this option.</p> <p>Digits received, after the specified maximum number of digits is received, are ignored.</p>

ACHEAD (continued)

Digit string checking options (Sheet 2 of 2)

Field	Refinements, values, and explanations
Field MAXIDX	<p>STD (0-9), B, or F (default: 9) Typical input: MAXIDX B Maximum index</p> <p>The translation tables are indexed by dialed digits. The default case is that these digits fall in the range of 0 to 9. Certain code tables can be required to include hex B (*), hex C (#) or the range 0 to 9 and hex digits B, C, D, E, and F in their indexes. For example, feature access codes can have format *XX, where * is hex B. (B is specified in field MAXIDX in the HEAD table.)</p>

Universal translation tables digit string manipulation options

The digit string presented for translation at each stage of universal translations determines what digit string, if any, is presented to the next stage of translation or routing. The digit string presented for translation at any stage is the result of digit manipulations in the preceding stages.

In addition to being used for translation of the call, the received digits determine what digit string, if any, is recorded for charging purposes and what digit string, if any, is outputted.

Each of the digit manipulation options in various translation tables can affect all or some of the three-digit strings (digit string for translation in the next stage, the call detail record digit string, and the outputted digit string).

The universal translation tables digit manipulation options, listed and described in the following table, can occur in one or more tables as detailed on the following pages.

Digit string manipulation options (Sheet 1 of 3)

Option	Refinements, values, and explanations
PF	<p>PFDIGS (0 to 24) Number of prefix digits Typical input: PF 1</p> <p>This is the number of prefix digits in the digit strings presented to this stage for translation, call detail recording, and outputting. Prefix digits are not used to index any further translation tables and are not outputted, but they do remain stored in call detail records (CDR).</p>
CON or NOCON	<p>(Default: NOCON) Consume digits Typical input: CON</p>

ACHEAD (continued)**Digit string manipulation options (Sheet 2 of 3)**

Option	Refinements, values, and explanations
	<p>This option applies if the result of translations in the current stage points to further digit translation in the following stage.</p> <p>If this option is set not to consume leading digits required to index into the current stage, the digit string presented for translation in the following stage is the same as the digit string presented for translation in the current stage less any leading prefix (PF or CONSUME) digits.</p> <p>If this option is set to consume leading digits required to index into the current stage, the digit string presented for translation in the following stage is the same as the digit string presented for translation in the current stage less PF leading digits, that is, excluding the prefix digits, if any, and less the leading digits following the prefix digits, if any, required to index into the current stage.</p> <p>Note: This option does not affect the digit strings for call detail recording and outpulsing.</p>
AFTER	<p>AFTER (0 to 29) Number of digits to skip Typical input: AFTER 2</p> <p>This option is used with options DEL, INSRT, and REPL to define the number of leading digits to be skipped after the prefix digits before deleting, inserting, or replacing digits.</p> <p>All these operations affect all three-digit strings; that is, the digit string presented to the next translation stage, the call detail record digit string, and the outpulsed digit string.</p>
DEL	<p>DELDIGS (0 to 29) Number of digits to delete Typical input: DEL 2</p> <p>This option specifies the number of leading digits to be deleted from the digits string presented for translation in this stage after deleting PF leading digits and after skipping the prescribed number of digits.</p> <p>The digits to be deleted are processed by the DMS switch before inserting digits using the option INSRT.</p> <p>The digits are deleted from all three-digit strings, that is, the digit string presented to the next translation stage, the call detail record digit string, and the outpulsed digit string.</p>
INSRT	<p>INSRDIGS (string of up to 29 digits) Digits to insert Typical input: INSRT 27</p>

ACHEAD (continued)

Digit string manipulation options (Sheet 3 of 3)

Option	Refinements, values, and explanations
	<p>This option specifies the digits to be inserted into the digit string presented for translation in this stage, after deleting PF leading digits and after skipping the prescribed number of digits.</p> <p>The digits to be deleted using option DEL are processed by the DMS switch before inserting digits.</p> <p>Digit replacement using option REPL cannot be done in the same tuple as digit insertion through option INSRT. If both options are datafilled, the second one in the tuple is used.</p> <p>The digits are inserted into all three-digit strings, that is, the digit string presented to the next translation stage, the call detail record digit string, and the outpulsed digit string.</p>
REPL	<p>REPLDIG (string of up to 30 digits) Replacement digits Typical input: REPL 4522453</p>
	<p>This option specifies the digits that are to replace those in the digit string presented for translation in this stage, after deleting PF leading digits and after skipping the prescribed number of digits.</p> <p>Digit replacement through option REPL cannot be done in the same tuple as digit insertion through option INSRT. If both options are datafilled, the second one in the tuple is used.</p> <p>The digit replacement occurs in all three-digit strings, that is, the digit string presented to the next translation stage, the call detail record digit string, and the outpulsed digit string.</p>
VPNREPL	<p>VPN Replace digits Typical input: VPNREPL</p>
	<p>Provides full Private Integrated Node Exchange (PINX) functionality on a public node. It is required to trigger translation on the virtual private network (VPN) number received in a parameter of an IAM/SGM message in a Q.VPN TCAP Setup.Invoke component.</p> <p>The VPNREPL option replaces the called party number with the VPN digits (private called party address) and continues translation.</p>
VPNXLT	<p>VPN Replace translation Typical input: VPNXLT</p>
	<p>The VPNXLT option replaces the translation system and translator name with the values from table BGIDMAP. The entry in table BGIDMAP is addressed by the NNI BGID and SIGNIFICANCE information received in the originating signaling for the call. The VPNXLT option and the XLT option cannot both exist in the same tuple.</p>

ACHEAD (continued)**Universal translation tables options for screening and charging**

The universal translation tables options for charging or screening, listed and described in the following table, can occur in one or more tables, as detailed on the following pages.

In general, if the same option is found in two different tuples during a pass through translation, the value in the last tuple is used. For example, if option CLASS is set to LCL in table PXC CODE, it can be reset to NATL in table FACODE.

Screening and charging options (Sheet 1 of 4)

Option	Refinements, values, and explanations
ACF	<p>ACF (0 to 29) Area code fence Typical input: ACF 3</p> <p>This option is used for inserting overdecadic connection control digits on China CAS trunks. No digits are prefixed or consumed before ACF processing. The digit position is recalculated after digit manipulation of the outpulsed digits.</p>
AMAXLAID	<p>XLAID Typical input: AMAXLAID FREE</p> <p>Automatic message accounting translations identification is used to indicate whether the international centralized automatic message accounting (ICAMA) record is generated with a signal DN or a public switched telephone network (PSTN) number. XLAID can be datafilled with the values FREE, GENERIC1, GENERIC2, or GENERIC3.</p>
CALLCTRL	<p>CALLCTRL (see list below) Call control Typical input: CALLCTRL LAST</p> <p>Calling control indicates which party has control of the release of a call. The following options are available:</p> <p>CALLING The calling party releases the call by going on-hook. If the called party goes on-hook and the calling party does not, the call is reconnected if the called party goes off-hook again before the reanswer timer expires.</p> <p>CALLED The called party releases the call by going on-hook. If the calling party goes on-hook and the called party does not, the call is reconnected if the calling party goes off-hook again before the reanswer timer expires.</p> <p>LAST The calling party or called party releases the call when the last one goes on-hook.</p> <p>MUTUAL The calling party or the called party releases the call when either party goes on-hook.</p>
CAMA	<p>CLDFMT (see list below) Typical input: CLCAMA CURRENT</p>

ACHEAD (continued)

Screening and charging options (Sheet 2 of 4)

Option	Refinements, values, and explanations
CLASS	<p>Centralized automatic message accounting is used for terminator billing through the translations tables. The options are:</p> <p>CURRENT This option indicates that an ICAMA record is produced with the signaled DN without translations.</p> <p>POSTXLA This option indicates that an ICAMA record is produced with the public switched telephone network (PSTN) number with translations.</p> <p>CLASS (see list below) Translation class Typical input: CLASS LCL</p> <p>The DMS-100 switch recognizes the following translation classes:</p> <p>ATT Attendant (business services only)</p> <p>CNTL Continental call (international call within the same continent)</p> <p>COLL Collect call</p> <p>DATT Dial attendant (business services only)</p> <p>EMRG Emergency call</p> <p>IAGRP Intragroup call (business services only)</p> <p>ICNTL Intercontinental call (international call to a different continent)</p> <p>INTL International call</p> <p>IOPRA International operator-assisted call</p> <p>LCL Local call</p> <p>NATL National call (within the nation, but nonlocal tariff)</p> <p>OPRA Operator-assisted call</p> <p>RURAL Rural call</p> <p>SPEC Special call (for example, repair service or call to operator)</p> <p>UNKW Unknown class (this can be used if the class cannot be determined yet, for example, ambiguous codes)</p> <p>URBAN Urban call</p>
LNET	<p>LNET (string in LNETWORK) Logical (metering) network Typical input: LNET LOCAL</p> <p>This option is used by the DMS international metering system to find a tariff for the call. This network is a string that must already be datafilled in table LNETWORK.</p>
MZONE	<p>MZONE (0 to 63) Metering zone Typical input: MZONE 2</p>

ACHEAD (continued)**Screening and charging options (Sheet 3 of 4)**

Option	Refinements, values, and explanations
NETSRV	<p>This option specifies the metering zone of the call in the logical network above. It is used by the DMS international metering system to determine a tariff for the call.</p> <p>NETSRV_NAME Network service name Typical input: NETSRV IPHS</p> <p>This option identifies a Japan network service. The entry in this field determines the parameters in an outgoing IAM message. The following network services are available:</p> <p>IPHS Identifies a call to an independent personal handyphone system (IPHS) subscriber</p> <p>DPHS Identifies a call to a dependent personal handyphone system (DPHS) subscriber</p> <p>MOBILE Identifies a call to a mobile subscriber</p> <p>DA Identifies a call to the directory assistance (DA) operator</p> <p>TELEGRAM Identifies a call to the Telegram office</p> <p>NCC Identifies a call routed to one of the following networks:</p> <ul style="list-style-type: none"> • New Common Carrier serving international toll traffic • New Common Carrier serving national toll traffic
PF	<p>PFDIGS (0 to 24) Number of prefix digits Typical input: PFDIGS 1</p> <p>This is the number of prefix digits in the digit strings presented to this stage for translation, call detail recording, and outpulsing. Prefix digits are not used to index any further translation tables and are not outpulsed, but they do remain stored in call detail records (CDR).</p>
PRESEL	<p>PRESEL Preselection call processing</p> <p>This option provides a means of optionality for preselection and provides the necessary information used to index into table PCIXLA. The preselection call class (PRESELECT, OVERRIDE, or CALLTYPE) associated with each call depends on the xxCODE table datafill that is used.</p>
PRIVL	<p>If the entry in PRIVL is N (no) or is omitted, the call is not affected by this option.</p> <p>If the entry in PRIVL is Y (yes), calls from privileged originators (for example, operators) can proceed, whereas calls from non-privileged originators are treated as if no match for the digits dialed is found so that the default prescription of table (XLASYS)HEAD field DFLT is taken, which is usually datafilled to block the call by sending it to treatment VACT (vacant code).</p>

ACHEAD (continued)

calls in which the subscriber prefixed a 00), for the originating toll to distinguish between a KA and a KOA from the originating local office.

Line-to-trunk reanswer timing

The translation class determines the reanswer timing for line-to-trunk calls, as shown below.

- If the CLASS is ATT, DATT, IAGRP, LCL, RURAL, UNKW, or URBAN, the duration of reanswer timing is found in office parameter LINE_LOCAL_CALL_REANS_TMO in table OFCVAR.
- If the CLASS is EMRG, or SPCL, the duration of reanswer timing is found in office parameter LINE_SPCL_CALL_REANS_TMO in table OFCVAR.
- If the CLASS is CNTL, ICNTL, INATL, or NATL, the duration of reanswer timing is found in office parameter LINE_TOLL_CALL_REANS_TMO in table OFCVAR.
- If the CLASS is IOPRA, OPRA, or other not listed above, there is no reanswer timing.

Line-to-trunk toll no-answer timing

The translation class determines the no-answer timing for line-to-trunk toll calls as specified in table PREANSTO.

Line-to-line reanswer timing

The translation class determines the reanswer timing for line-to-line calls as shown below.

- If the CLASS is ATT, DATT, IAGRP, LCL, RURAL, UNKW, or URBAN, the duration of reanswer timing is found in office parameter LINE_LOCAL_CALL_REANS_TMO in table OFCVAR.
- If the CLASS is EMRG, or SPCL, the duration of reanswer timing is found in office parameter LINE_SPCL_CALL_REANS_TMO in table OFCVAR.
- If the CLASS is CNTL, ICNTL, INATL, IOPRA, NATL, OPRA, or other not listed above, there is no reanswer timing.

China local and toll busy

If an incoming Chinese #1 (C1) multifrequency compelled (MFC) trunk routes to a busy subscriber, the call that the subscriber is already involved in must be looked at to determine whether the subscriber is local busy or toll busy.

ACHEAD (continued)

If the originating agent of the call is a line, the translation class determines whether the call is local or toll busy as shown below.

- If the CLASS is CNTL, ICNTL, INTL, or NATL, the call is considered toll busy.
- If the CLASS is other than CNTL, ICNTL, INTL, or NATL, the call is considered local busy.

Universal translation tables options for routing

The universal translation tables routing options are described below.

Translation tables routing options (Sheet 1 of 7)

Selector	Refinements, values, and explanations
XLASEL	Table xxHEAD, field DFLT, and table xxCODE, field XLADATA, have identical formats. The format consists of a translation selector, a group of options for routing, digit manipulation, screening, and charging.
	Typical input: CLASS
	<p>CONT</p> <p>This option specifies that translation continues in a translation system code table (xxCODE) using the translation name (XLANAME) after processing the other options in the same tuple.</p>

ACHEAD (continued)**Translation tables routing options (Sheet 2 of 7)**

Selector	Refinements, values, and explanations
	<p>CONT has the following options:</p> <ul style="list-style-type: none"> • ACF Area Code Fence • AMAXLAID Automatic message accounting XLA ID • BLKOVLP Block Overlap Outputing • CALLCNTL Call control • CAMA Centralized automatic message accounting • CATRTE Category routing • CDN Called Number • CDNRTE Called Number Route • CLASS Translation class • CLIOVRD Calling Line Identity Override • CONSUME Consume digits • CPCRTE Calling Party Category Route • DDIDX Destination Discount Index • DEST Destination • EXTCIC External Carrier identification code • IAA Interadministration accounting • LNET Logical network name • MM Minimum and maximum number of digits expected • MZONE Metering zone • NETSRV Network service • NICRF NIC routing function • OSS Operator Service System • PCC Pseudo Country Code • PF Prefix fence • PNRF Ported Number Recognition Function • PORTED Ported number indicator • PRESEL Preselection call processing • PRIVL Privileged call • QFT QSIG Feature Transparency • SETCDN Set Called Number Name
	<ul style="list-style-type: none"> • TOC Type of Change • VPN Operate the PINX • XLT Translate

ACHEAD (continued)

Translation tables routing options (Sheet 3 of 7)

Selector	Refinements, values, and explanations
DBQ	<p style="text-align: right;">Typical input: NSC</p>
	<p>This option specifies that translation continues in a translation system code table (xxCODE) using the translation name (XLANAME) after processing the other options in the same tuple.</p>
	<p>DBQ has the following options:</p>
	<ul style="list-style-type: none"> • MM Minimum and maximum digits • NSC Number service code • PF Prefix fence
DMOD	<p style="text-align: right;">Typical input: DEL</p>
	<p>This option specifies that translation continues in a translation system code table (xxCODE) using the translation name (XLANAME) after processing the other options in the same tuple to modify the digit string.</p>
	<p>DMOD has the following options:</p>
	<ul style="list-style-type: none"> • AFTER Insert after • CATRTE Category routing • CDNRTE Called number route • CONSUME Consume digits • CPCRTE Calling party category route • DEL Delete digits • EXTCIC External carrier identification code • INSRT Insert digits • PF Prefix fence • RBP Ringback price • REPL Replace digits • SETCDN Set called number • VPNREPL Virtual Private Network replace digits • VPNXLT Virtual Private Network replace translation • XLT Translation
DNRTE	<p style="text-align: right;">Typical input: MM</p>

ACHEAD (continued)**Translation tables routing options (Sheet 4 of 7)**

Selector	Refinements, values, and explanations
	<p>This option specifies that translation continues to the DNINV table at AREACODE, DFCCODE (as datafilled in option DN).</p> <p>DN RTE has the following options:</p> <ul style="list-style-type: none"> • ALLOWOVLP Allow overlap • AMAXLAID Automatic message accounting XLA ID • CAMA Centralized automatic message accounting • CLASS Translation class • DN Directory number • MM Minimum and maximum number of digits expected • PF Prefix fence • SF Station fence <p>FEAT Typical input: FTR</p> <p>This option specifies an international line feature.</p> <p>FEAT has the following options:</p> <ul style="list-style-type: none"> • FTR Vertical service code (VSC) • FUNC Function code • MM Minimum and maximum number of digits expected • PF Prefix fence • XLT Translation system <p>FEATINFO has the following options:</p> <ul style="list-style-type: none"> • VSC Vertical service code • VALIDATE Validate (not used in GL03) • CALLBACK Call back • CALLCHAR Call charge • CLCTDIGS Collect digits • JES Japan Emergency Service • NTC Notification of time and charge • TLC Test line call <p>HRC Typical input: PFBILL</p>

ACHEAD (continued)

Translation tables routing options (Sheet 5 of 7)

Selector	Refinements, values, and explanations
	<p>This option specifies that translation continues to the current xxCODE table at XLANAME, after processing the other option in the same tuple.</p>
	<p>HRC has the following options:</p>
	<ul style="list-style-type: none"> • PFBILL Prefix fence billing
	<ul style="list-style-type: none"> • XLT Translations table
IAC	Typical input: PF
	<p>This option specifies that translation continues to the current xxCODE table at XLANAME, after processing the other option in the same tuple.</p>
	<p>IAC has the following options:</p>
	<ul style="list-style-type: none"> • PF Prefix fence
RTE	Typical input: DEST
	<p>This option specifies that translation continues to the current xxRTE table at XLANAME and specified route index DEST, after processing the other option in the same tuple.</p>

ACHEAD (continued)**Translation tables routing options (Sheet 6 of 7)**

Selector	Refinements, values, and explanations
	<p>RTE has the following options:</p> <ul style="list-style-type: none"> • ACF Area code fence • AMAXLAID Automatic message accounting XLA ID • BLKOVLP Block overlap • CAMA Centralized automatic message accounting • CALLCTRL Call control • CATRTE Category routing • CDN Called number • CDN RTE Called number route • CHGIND change indicator • CLASS Translation class • CONSUME Consume digits • CPCRTE Calling party category route • DDIDX Destination discount index • DEST Destination • EXTCIC External carrier identification code • IAA Interadministrative accounting • LNET Logical network name • MM Minimum and maximum number of digits expected • MZONE Metering zone • NETSRV Network service • PCC Pseudo country code • NICRF NIC routing function • PF Prefix fence • PIP Peripheral interchange process • PNRF Ported number recognition function • PORTED Ported number indicator • PRESEL Preselection call processing • PRESEL RTE Preselection route • PRIVL Privileged • QFT QSIG Feature Transparency
	<ul style="list-style-type: none"> • SETCDN Set Called Number <small>UCS Data Schema Reference Manual, Volume 1 of 5 UCS15</small> • TOC Type of charge • VPN Operate PINX • VPNPAN Operate the PINX as a Public Address Node (PAN)

ACHEAD (continued)

Translation tables routing options (Sheet 7 of 7)

Selector	Refinements, values, and explanations
TRMT	Typical input: OFC
	This option specifies that translation proceeds to table TMTCNTL, subtable OFFTREAT at TREATMT. TRMT is a known exception or failure condition.

Universal translation tables datafill sequence

Within a particular translation system, an xxHEAD table tuple must be datafilled before the corresponding xxCODE or xxRTE tables. This is because the XLANAME does not exist until it is defined in the xxHEAD table. Similarly, an XLANAME cannot be referenced (with option XLT) from another table until it is defined in the xxHEAD table of its own translation system. For example, option XLT OFC OFC1 cannot be datafilled in table PXCODE until a tuple with XLANAME OFC1 has been defined in table OFCHEAD.

Miscellaneous notes

If an entry is deleted from a HEAD table, all CODE and RTE table entries with the given XLANAME are also deleted. However, all XLT references to the deleted XLANAME in other tables must be removed manually. If references to deleted XLANAMES are not removed, translation cannot continue when it reaches the missing reference, and a call dump occurs. This applies to all universal translation systems.

Tables TRKGRP and NETATTR are also affected.

This document covers the information required to datafill the following universal translations xxHEAD tables:

- ACHEAD
- AMHEAD
- CTHEAD
- FAHEAD
- FTHEAD
- OFCHEAD
- PXHEAD

ACHEAD (continued)

Functional description

The head tables define the instances of CODE and RTE tables and their characteristics. All HEAD tables have an identical format for the options they contain.

Datafill sequence and implications

If field XLASEL (translation selector) is datafilled with DBQ, table NSCDEFS must be datafilled before table ACHEAD.

If the optional selector CGNDM is used with translation selector DMOD, the default calling line identification (CLI) must be datafilled in table TRKSGRP. Different default CLIs can be datafilled on requirements.

Optional selector CGNDM must also be datafilled in table ACCODE to activate feature AQ0987 (Calling-Party-Number Digit Manipulation).

When datafilling the xxHEAD and xxCODE tables, if translation selector DNRTE is used, table DNINV must be datafilled before table ACHEAD. If option AMAXLAID is also used with selector DNRTE, or CONT or RTE, table AMAXLAID must be datafilled before table ACHEAD.

Table ACHEAD interacts with the following office parameters in table OFCVAR:

- ICAMA_REQUESTED
- IAA_REQUESTED
- IMEI_ACCEPTABLE_FOR_EMRG_CALL

For the option selector CAMA, used in translation selectors CONT, DNRTE, and RTE, set office parameter ICAMA_REQUESTED to Y (yes) in table OFCVAR if international centralized automatic message accounting (ICAMA) detailed call recording is required.

An international automatic accounting (IAA) record can be generated by selecting office parameter IAA_REQUESTED in table OFCVAR, and the CAMA selector.

Office parameter IMEI_ACCEPTABLE_FOR_EMRG_CALL in table OFCVAR provides an option for the network operator to accept emergency call setups from mobile stations that transmit the international mobile equipment identifier (IMEI) instead of the international mobile subscriber identifier (IMSI) or temporary mobile subscriber identifier (TMSI). The default value allows emergency call setups with IMEI as the identifier if, for example, no serial interface module (SIM) is present.

ACHEAD (continued)

Only automatic number identification (ANI) and international metered (MTR) trunk group originations currently support option selector CAMA. All other call types ignore this translation option.

For emergency call translation, class EMRG must be datafilled. This can be done before or after translation selector DMOD with option selector COODM. This requirement differentiates between normal mobile-originated calls and emergency calls setup by a conventional SETUP message.

If options CDNRTE and CPCRTE are both present in one tuple in table xxHEAD, call processing accesses routing tables in the following order: table CPCUXLA is accessed first. If no match is found, table CDNUXLA is accessed next.

If options SETCDN and CDNRTE are both present in one tuple in table xxHEAD, call processing accesses table CDNUXLA first, before the SETCDN option sets the called number name (CDNNAME).

Datafill guidelines

A tuple in an xxHEAD table consists of the name of the xxCODE and xxRTE tables, and some or all of the xxHEAD table options listed below:

- DFLT (xxCODE table tuple)
- DFOP (xxCODE table options)
- CON (consume)
- MAXIDX (hexadecimal digit)

The options entered at the DFLTSEL prompt define DFLT.

The options entered at the DFOPSEL prompt define DFOP.

The options entered at the XLASYS prompt define TABREF.

A description of each option is given in the following table.

xxHEAD table options (Sheet 1 of 2)

Option	Descriptions
DFLT	<p>DEFAULT</p> <p>Translation uses this data if the dialed digits are not datafilled in the xxCODE table associated with this xxHEAD tuple. Any valid xxCODE table tuple can be specified with this option.</p>

ACHEAD (continued)**xxHEAD table options (Sheet 2 of 2)**

Option	Descriptions
DFOP	<p>DEFAULT OPTIONS</p> <p>If dialed digits use a RTE or CONT selector, any options not datafilled against the digits can be defaulted to the value specified here. This facility, and the DFLT option, are intended to minimize the amount of datafill required in any given xxCODE table, especially if most of the expected xxCODE tables have the same attributes. If an option is applicable to most, but not all, tuples in the xxCODE table, the option can still be datafilled in the default options. Options datafilled in the xxCODE table tuples override the options in the xxHEAD table, so that different values can be datafilled into those xxCODE tuples to which the default option does not apply.</p>
CON	<p>CONSUME DIGITS</p> <p>This option applies to the CONT selector of an xxCODE table. The default case is not to consume digits. That is, the next table is indexed using the same digits as the current table, except for ignoring prefix digits. Under certain conditions, the next table is indexed starting with the digits following the index to the current table (translations absorb or consume the current index digits). For example, an area code is found in table FACODE. Table OFCCODE is indexed with the digits following the area code (the office code), so the digits used to index table FACODE are consumed. This does not mean that the digits are deleted from the digit register. They are still there and are outpulsed unless explicitly deleted in the xxCODE or xxRTE tables. The CON option means that these digits are not used to index the next table.</p>
MAXIDX	<p>MAXIMUM INDEX</p> <p>The translation tables are indexed by dialed digits. These digits default to the range of 0 to 9. Certain xxCODE tables can be datafilled to include hex B (*), hex C (#), or the range 0 to 9 and hex digits B, C, D, E, and F in the index. For example, feature access codes can have format *XX (where * is hex B). B is specified in field MAXIDX in the xxHEAD table.</p>

Table size

Memory is automatically allocated to a maximum of 2047 tuples. The size is initially set to 64 and the table extends automatically.

ACHEAD (continued)**Datafill**

The following table lists datafill for table ACHEAD. Tables ACCODE and ACRTE are referenced. However, any valid system prefix can be used in each set of tables.

Field descriptions (Sheet 1 of 3)

Field	Subfield	Entry	Explanation and action
XLANAME		alphanumeric (1 to 8 characters)	Translation name. Enter the name assigned to the universal translator.
CONTMARK		+	Continuation mark. Enter + to indicate that additional information for this tuple is contained in the next record.
DFLT		see subfield	Default translations data. This is the result that translations uses if the dialed digits are not datafilled in the ACCODE table associated with table ACHEAD. This field consists of subfield DFLTSEL and refinements dependent on the entry in field DFLTSEL.
	DFLTSEL	DFLT or SDFLT	Default selector. Enter DFLT and datafill refinement XLASEL if the standard default is not correct. Enter SDFLT, if a standard default is required for dialed digits not found in the ACCODE table. The standard default is TRMT OFC VACT. That is, if dialed digits are not found in ACCODE, the call is routed to vacant code treatment. No additional datafill is required.
	XLASEL	CONT, DBQ, DMOD, DNRTE, FEAT, FEATINFO, HRC, IAC, RTE, or TRMT	Translations selector. Enter CONT and datafill refinement CONT if further translation is required. Enter DBQ and datafill refinement DBQ to perform a database query.

ACHEAD (continued)**Field descriptions (Sheet 2 of 3)**

Field	Subfield	Entry	Explanation and action
			<p>Enter DMOD and datafill refinement DMOD if input digit stream modification is required.</p> <p>Enter DNRTE and datafill refinement DNRTE if input digit routing is required.</p> <p>Enter FEAT and datafill refinement FEAT if access to a feature is required.</p> <p>Enter FEATINFO and datafill refinement FEATINFO to trigger the screening function.</p> <p>Enter HRC and datafill its refinements if the home routing code selector is required for local number portability applications.</p> <p>Enter IAC and datafill refinement IAC if the insertion of own area code is required when an ambiguous area code is found through translations.</p> <p>Enter RTE and datafill refinement RTE if a translation result was found, and translation is to terminate.</p> <p>Enter TRMT and datafill refinement TRMT if a call is routed to a treatment.</p>

ACHEAD (continued)**Field descriptions (Sheet 3 of 3)**

Field	Subfield	Entry	Explanation and action
	DFOP	DFOP or NODFOP	<p>Default options. Enter DFOP and datafill subfield OSEL and its refinements.</p> <p>The default options apply only if a tuple with field XLASEL set to RTE or CONT is chosen in the CODE table.</p> <p>If the entry in field DFOP is equal to DFOP, this field is a vector that consists of a number of options. Each option, consisting of subfield OSEL and refinements dependent on the entry in subfield OSEL, is separated from the next by a space. The various refinements are identical to the refinements described in field DFLT, selector CONT, subfield OSEL.</p> <p>For each option, specify the option selector, followed by a space, and the refinements, with each refinement separated from the next by a space. The entry is concluded by a \$ and datafill continues with field CON.</p> <p>Enter NODFOP if there are no default options and datafill field CON.</p>

XLASEL = CONT

If the entry in field XLASEL is CONT, datafill the following refinements.

ACHEAD (continued)

Table AMAXLAID must be datafilled prior to selecting option AMAXLAID in field OSEL.

ACHEAD (continued)**Field descriptions for conditional datafill (Sheet 1 of 15)**

Field	Subfield	Entry	Explanation and action
	OPT	see subfield	Options. This field is a vector consisting of up to ten options. Each option consists of subfield OSEL and refinements that depend on the entry in subfield OSEL. For each option, specify the option selector (OSEL), followed by a space, and the refinements, each separated by a space. The entry is concluded by a \$ and datafill continues with field DFOP.
	OSEL	ACF, AMAXLAID, CALLCTRL, CAMA, CATRTE, CDN, CDNRTE, CHGIND, CLASS, CLIOVRD, CONSUME, CPCRTE, CPMCALL, DDIDX, DEST, DFT , EXTCIC, IAA, LNET, MM, MZONE, NETSRV, NICRF, NOANSTIM, OSS, PCC, PF, PNRF, PORTED, PRESEL, PRIVL, QFT, SETCDN, TELETAXE, TOC, VPN, XLT	<p>Option selector. The following options can be selected:</p> <p>Enter ACF, followed by a space, and datafill refinement ACF if the area code fence is defined.</p> <p>Enter AMAXLAID, followed by a space, and datafill refinement XLAID to specify an automatic message accounting (AMA) identity from within table AMAXLAID.</p> <p>Enter CALLCTRL, followed by a space, and datafill refinement CALLCTRL. The entry in refinement CALLCTRL indicates who has control of the call: the calling party, the called party, or both.</p> <p>Enter CAMA, followed by a space, and datafill refinement CLDFMT. The entry in field CLDFMT indicates whether the international centralized automatic message accounting (ICAMA) record is generated with the the originally signaled directory number (DN) or the final public switched telephone network (PSTN) number.</p> <p>Enter CATRTE to allow charge category routing in IBN translations.</p> <p>Enter CDN, followed by a space, and datafill refinement CDN to select the nature of address field. This field is used to identify the called party of the initial address message (IAM). It is used for Australian ISDN user part (AISUP) call translations.</p>

ACHEAD (continued)

Field descriptions for conditional datafill (Sheet 2 of 15)

Field	Subfield	Entry	Explanation and action
			<p>Enter CDN RTE to route using the called number name (CDNNAME) from table CDNCHAR. If the CDNNAME is present on the incoming call or is set by the SETCDN option, translation proceeds to table CDNUXLA.</p> <p>Enter CHGIND, followed by a space and datafill refinement CHGIND to override the charge indicator value received from an incoming trunk message. This entry is specific to JCTV.</p> <p>Enter CLASS, followed by a space, and datafill refinement CLASS if the class of the dialed digits can be determined.</p> <p>Enter CLIOVRD, followed by a space, and enter data for refinement CLIOVRD. This subfield indicates calling line identity override.</p> <p>Enter CONSUME, followed by a space, and datafill refinement CONDIGS to specify the number of digits that are consumed during translation.</p> <p>Enter CPC RTE to route using the calling party category (CPCNAME) from table CPCCHAR. If the CPCNAME is present on the incoming call, translation proceeds to table CPCUXLA.</p> <p>Enter CPMCALL, followed by a space, and datafill refinement CPMCALL to specify call billing against the called party instead of the calling party for intra-office calls.</p> <p>Enter DDIDX, followed by a space, and enter data for refinement DDIDX. Enter data for this subfield for the destination discount index.</p> <p>Enter DEST, followed by a space, and datafill refinement DEST if the destination is known.</p> <p>Enter DFT for DPNSS feature transparency functionality.</p>

ACHEAD (continued)

Field descriptions for conditional datafill (Sheet 3 of 15)

Field	Subfield	Entry	Explanation and action
			<p>Enter EXTCIC, followed by a space, and enter data for refinements CICSIZE, SKIPDIGS, or SOURCE. Enter EXTCIC for the external carrier identification code</p>
			<p>Enter IAA and the datafill refinement IAA_INDEX to generate or modify IAA message parameters based on datafill in table IAACtrl.</p>
			<p>Enter LNET, followed by a space, and datafill refinement LNET if a logical network is required for metering.</p>
			<p>Enter MM, followed by a space, and datafill refinements MIN and MAX if the minimum and maximum dialed digits are known.</p>
			<p>Enter MZONE, followed by a space, and datafill refinement MZONE if metering is to be done on the call.</p>
			<p>Enter NETSRV and datafill refinement NETSRV_NAME to indicate a Japan network service.</p>
			<p>Enter NICRF to activate the Network Identification Code (NIC) routing function. Note that the NICRF and PNRF options are incompatible and cannot be datafilled on the same tuple.</p>
			<p>Enter NOANSTIM to the RTE selectors. This turns the T9 timer off in the outgoing ISUP trunk, if encountered.</p>
			<p>Enter OSS for the operator signaling service. The OSS subfield does not have refinements.</p>
			<p>Enter PCC, followed by a space, and datafill refinement PCCDR if a pseudo country code is required.</p>
			<p>Enter PF, followed by a space, and enter data for refinement PFDIGS. Enter data for this subfield if the digit stream contains prefix digits.</p>

ACHEAD (continued)

Field descriptions for conditional datafill (Sheet 4 of 15)

Field	Subfield	Entry	Explanation and action
			<p>Enter PORTED to indicate that a previous node identified that this call is to a ported number.</p> <p>Enter PNRF to invoke the ported number recognition function.</p> <p>Enter INSNNG and its subfields.</p> <p>Note that the NICRF and PNRF options are incompatible and cannot be datafilled on the same tuple.</p> <p>Enter PRESEL, followed by a space, and datafill refinement PRESEL to provide the necessary information used to index into the PCIXLA table.</p> <p>Enter PRIVL, followed by a space, and datafill refinement PRIVL if the user is a privileged user (for example, operators).</p> <p>Enter QFT followed by ON or OFF to indicate if an outgoing route is capable of QSIG Feature Transparency.</p> <p>Note: The QFT ON option must not be added to a route unless the far-end node is QFT-capable.</p> <p>Enter SETCDN to trigger the setting of outgoing called party characteristics. This option assigns the called number name (CDNNAME) from table CDNCHAR to the call. If the CDNRTE option is subsequently encountered, the CDNNAME is used to route the call.</p> <p>You can use the SETCDN option to allow CDN routing when incoming agents such as DPNSS or BTUP are not available in table CDNCHAR.</p> <p>Enter TELETAXE. This subfield does not have refinements.</p>

ACHEAD (continued)**Field descriptions for conditional datafill (Sheet 5 of 15)**

Field	Subfield	Entry	Explanation and action
			Enter TOC, followed by a space, and datafill refinement CHG for the type of charge if the type of charge messaging is selected.
			Enter VPN, followed by a space, and datafill refinements ONNET and BILLABLE if the call routes through a service switching point (SSP) and the Australian VPN - SSP feature is present in the switch.
			Enter XLT, followed by a space, and datafill refinement XLASYS if the call is to proceed to another translation system.
	ACF	0 to 29	Area code fence. If the entry in subfield OSEL is ACF, datafill this refinement. Enter the number of digits between the beginning of the digits to currently index the table, and the end of the area code.
	BILLABLE	Y or N	Virtual private network billable call. If the entry in subfield OSEL is VPN, datafill this refinement. Enter Y if an AMA record is required for each VPN call. Otherwise, enter N. An AMA record is not generated if an address complete message (ACM) of address complete - no charge is returned, or if the call terminates in the SSP on a line with the free number terminating (FNT) option.
		PRESELECT OVERRIDE, CALLTYPE, CSN, or TRUNK	Preselection call processing. If the entry in subfield OSEL is PRESEL, datafill this refinement. Enter the preselection call class type that is associated with the call. For charge category routing, enter CALLTYPE.
			Note: Calltype CSN and TRUNK are available under the PRESEL option. These call classes are not needed for German Carrier Selection, and are not supported. The same applies to the Continue option of CONT. For the German market only, NOCONT is supported.

ACHEAD (continued)**Field descriptions for conditional datafill (Sheet 6 of 15)**

Field	Subfield	Entry	Explanation and action
	CALLCTRL	CALLED, CALLING, LAST, or MUTUAL	<p>Call control. If the entry in subfield OSEL is CALLCTRL, datafill this refinement. Enter one of the following values to specify the party controlling the call:</p> <ul style="list-style-type: none"> If the entry is CALLED and the called party goes on-hook first, the call is released immediately. If the calling line goes on-hook first and does not reanswer, the connection is not released until the called line goes on-hook. There are no time-outs, and the calling party is allowed to reanswer until the called line goes on-hook. <p>Calls to lines with option ESG must have CALLCTRL(CALLED).</p> <p>Calls terminating on an International Traffic Operator Position System (ITOPS) must have CALLCTRL (CALLED).</p>
	CALLCTRL (continued)		<p>Call control (continued). Enter one of the following values to specify the party controlling the call:</p> <ul style="list-style-type: none"> If the entry is CALLING and the calling line goes on-hook first, the call is released immediately. If the called line goes on-hook first, the called party is allowed to reanswer within a datafilled reanswer time-out or until the calling line goes on-hook. If the time-out expires or if the calling line goes on-hook, the calling party releases the call and the called party is set to idle. If the entry is LAST, the call is released when the later of the called party or the calling party goes on-hook. If either party goes on-hook, that party is allowed to reanswer within a datafilled reanswer time-out or until both parties go on-hook. If the entry is MUTUAL and either line goes on-hook, the call is released immediately.

ACHEAD (continued)**Field descriptions for conditional datafill (Sheet 7 of 15)**

Field	Subfield	Entry	Explanation and action
	CDNNAME	alphanumeric string	If the entry in subfield OSEL is SETCDN, enter data for refinement CDNNAME. Enter CDNNAME to route the call using a called number name from table CDNCHAR.
	CHG	SEND_ CHARGE or SEND_NO_ CHARGE	Charge. If the entry in subfield OSEL is TOC, datafill this refinement. Enter SEND_CHARGE to set the answer message (BTUP ANM) type of answer (TOA) string sent out from a node to SEND_CHARGE. Enter SEND_NO_CHARGE to set the answer message (BTUP ANM) type of answer (TOA) string sent out from a node to SEND_NO_CHARGE.
	CHGIND	ASIS, CHG, or NOCHG	CHGIND indicates whether to override the value of the charge indicator in the Backward Call indicators. Datafill the CHGIND field with the following values: <ul style="list-style-type: none"> • ASIS—treat charge indicator as is • CHG—treat charge indicator as charge • NOCHG—treat charge indicator as no charge
	CICSIZE	1 to 4	CIC size. If the entry in subfield OSEL is EXTCIC, enter data for this refinement. This field indicates the number of digits in the CIC. This field operates on the B (called) number, so it is assumed that the switch signals the CIC as part of the B number. The MAP display indicates the range is 0 to 4. The system does not allow a 0 entry.

ACHEAD (continued)**Field descriptions for conditional datafill (Sheet 8 of 15)**

Field	Subfield	Entry	Explanation and action
	CLASS	ATT, CNTL, COLL, DATT, EMRG, IAGRP, ICNTL, INTL, IOPRA, LCL, NATL, OPRA, RURAL, SPEC, UNKW, or URBAN	<p>Translation CLASS. If the entry in subfield OSEL is CLASS, datafill this refinement. Enter the translation class determined by the dialed digits, as listed below. (This can be used for screening or billing purposes as described under CLASS in screening and charging options.)</p> <ul style="list-style-type: none"> • ATT (attendant console) • CNTL (continental) • COLL (collect) • DATT (dial attendant) • EMRG (emergency) • IAGRP (interagent group) • ICNTL (intercontinental) • INTL (international) • IOPRA (international operator assisted) • LCL (local) • NATL (national) • OPRA (operator assisted) • RURAL (rural) • SPEC (special) • UNKW (unknown) • URBAN (urban)
	CLDFMT	CURRENT or POSTXLA	<p>Called format. If the entry in subfield OSEL is CAMA, enter either CURRENT or POSTXLA to produce the required ICAMA record format.</p> <p>If the entry is CURRENT, an ICAMA record is produced with the signaled DN (without translation).</p> <p>If the entry is POSTXLA, an ICAMA record is produced with a public switched telephone network (PSTN) number resulting from translations.</p>

ACHEAD (continued)**Field descriptions for conditional datafill (Sheet 9 of 15)**

Field	Subfield	Entry	Explanation and action
	CLIOVRD	CNA, CNB	Calling line identity override. If the entry in subfield OSEL is CLIOVRD, enter data for this refinement. Enter CNA to allow the calling number for each call. Enter CNB to block the calling number for each call.
	CONDIGS	0 to 29 digits	Consumed digits. If the entry in subfield OSEL is CONSUME, datafill this refinement. Enter a number to explicitly define the number of digits consumed during call processing.
	CONTINUE	CONT, NOCONT	Continue. If the entry in subfield OSEL is PRESEL, enter data for this refinement. Enter CONT to continue translations through UXLA. Enter NOCONT to route translations through PCIXLA or PCITRK.
	CPMCALL	Y or N	Called party metering. If the entry in subfield OSEL is CPMCALL, datafill this refinement. Enter Y (yes) if calls are billed against the called party for intra-office calls. Enter N (no) for the default value of billing against the calling party for intraoffice calls.
	DDIDX	1 to 63 or DEFAULT	Destination discount index. If the entry in subfield OSEL is DDIDX, enter data for this refinement. Enter the destination discount index number from table ACOPT.
	DEST	0 to 1023	Destination route list index. If the entry in subfield OSEL is DEST, datafill this refinement. Enter the number in the route list of the translation system that the call is routed to.
	IAA_INDEX	0 to 1024	Interadministration accounting index. If the entry in subfield OSEL is IAA, datafill this refinement. Enter the value that indexes the corresponding tuple in table IAACRRL.

ACHEAD (continued)**Field descriptions for conditional datafill (Sheet 10 of 15)**

Field	Subfield	Entry	Explanation and action
	LNET	alphanumeric (1 to 16 characters)	Logical network. If the entry in subfield OSEL is LNET, datafill this refinement. Enter the logical network name that the call is on. The logical network name must be previously datafilled in table LNETWORK. The entry in this field is used by the international metering system to determine a tariff for the call.
	MAX	0 to 30	Maximum digits. If the entry in subfield OSEL is MM, datafill this refinement. Enter the maximum number of digits expected. This value includes the digits used to index the current tuple and must also include the prefix digits specified in the current tuple.
	MIN	0 to 30	Minimum digits. If the entry in subfield OSEL is MM, datafill this refinement. Enter the minimum number of digits expected. This value includes the digits used to index the current tuple and must also include the prefix digits specified in the current tuple.
	MZONE	0 to 63	Metering zone. If the entry in subfield OSEL is MZONE, datafill this refinement. Enter the metering zone of the call, in the logical network as defined by selector LNET. The entry in this field is used by the international metering system to determine a tariff for the call.

ACHEAD (continued)

Field descriptions for conditional datafill (Sheet 11 of 15)

Field	Subfield	Entry	Explanation and action
	NETSRV_ NAME	IPHS, DPHS, MOBILE, DA, TELEGRAM, or NCC	<p>Network service name. If the entry in subfield OSEL is NETSRV, datafill this refinement. The entry in this field determines the parameters in an outgoing IAM message.</p> <p>Enter IPHS to indicate a call to an independent personal handyphone system subscriber.</p> <p>Enter DPHS to indicate a call to a dependent personal handyphone system subscriber.</p> <p>Enter MOBILE to indicate a call to a mobile subscriber.</p> <p>Enter DA to indicate a call to the directory assistance operator.</p> <p>Enter TELEGRAM to indicate a call to the Telegram office.</p> <p>Enter NCC to indicate a call routed to one of the following networks:</p> <ul style="list-style-type: none"> • New Common Carrier serving international toll traffic • New Common Carrier serving national toll traffic
	NICRF	NICRF	<p>NIC routing function. This option allows transit calls prefixed with the NIC to access table PNINFO to route the call based on the NIC. Note that the NICRF and PNRF options are incompatible and cannot be datafilled on the same tuple.</p>
	NOA	INTL, LOCAL, NATL, or NET	<p>Nature of address. Enter the required called party nature of address as follows:</p> <ul style="list-style-type: none"> • INTL (international) • LOCAL (local) • NATL (national) • NET (Intelligent Network Services)

ACHEAD (continued)**Field descriptions for conditional datafill (Sheet 12 of 15)**

Field	Subfield	Entry	Explanation and action
	ONNET	Y or N	<p>Call on virtual private network. If the entry in subfield OSEL is VPN, datafill this refinement. Enter Y if the call stays within the defined virtual private network. Otherwise, enter N.</p> <p>Overlap outpulsing is supported only on off-network calls. Calls processed without subfield ONNET set to Y are off-network calls. Meridian Digital Centrex (MDC) calls are treated as off-network calls, and therefore overlap outpulsing is supported for MDC calls.</p>
	PCCDR	0 to 9, B, C, D, E (1 to 3 digits)	<p>Pseudo country code digits. If the entry in subfield OSEL is PCC, datafill this refinement. Enter the three-digit pseudo country code (PCC). If a two-digit PCC is required, it must be padded by a leading zero.</p> <p>The pseudo country code is used to record a particular pseudo country code. This can be extracted for use by system logic later, for example, two-stage outpulsing.</p>
	PFDIGS	0 to 24	<p>Number of prefix digits. If the entry in subfield OSEL is PF, datafill this refinement. Enter the number of prefix digits. If prefix digits are identified in a previous table, this number is added to the existing value. Prefix digits are not used to index any further translation tables and are not outpulsed, but they do remain stored in call detail records (CDR).</p> <p>Note: If refinements PF and CONSUME are both datafilled for the same tuple, only the entry for the greater of the two values is processed; the other entry is ignored.</p>
	PFXAMA	0 to 4 digits, or N	<p>Called party number prefix in AMA. If NOA is set to NTL, datafill PFXAMA with 0011.</p> <p>If NOA is set to NATL, datafill PFXAMA with 0.</p> <p>If NOA is set to LOCAL or NET, datafill PFXAMA with N.</p>

ACHEAD (continued)**Field descriptions for conditional datafill (Sheet 13 of 15)**

Field	Subfield	Entry	Explanation and action
	PNRF	PNRFOPTS	Ported number recognitions function. Datafill the PNRFOPTS options vector and the INSNG subfields:
	INSNG	See subfields PREFIX and TRUNK_ACCESS_DIG	
	PREFIX	0 to 11	PREFIX indicates the number of leading digits to be copied from an originator's DN and prefixed to the translating number.
	TRUNK_ACCESS_DIG	0 to 9, or N	TRUNK_ACCESS_DIG enables the specification of a trunk access digit to be prefixed to the translating number after the INSNG_PREFIX function has been completed.
	PORTED	PORTED or blank	Number portability indicator. This entry indicates that the service number for this call has been ported.
	PRIVL	Y or N	Privileged user. If the entry in subfield OSEL is PRIVL, datafill this refinement. Enter Y (yes), if the user is a privileged user (for example, operator). Otherwise, enter N (no).
	SKIPDIGS	0 to 24	Skip digits. If the entry in subfield OSEL is EXTCIC, enter data for this refinement. This field indicates the number of digits to skip before removing the carrier digits from the digit stream. This field operates on the B (called) number, so it is assumed that the system signals the CIC as part of the B number.

ACHEAD (continued)**Field descriptions for conditional datafill (Sheet 14 of 15)**

Field	Subfield	Entry	Explanation and action
	SOURCE	PRESUB or DIALED	<p>Carrier identification code source. If the entry in subfield OSEL is EXTCIC, enter data for this refinement. This field specifies the source of the CIC as follows:</p> <ul style="list-style-type: none"> • PRESUB - presubscribed. Table TRKGRP contains the definition of the CIC. • DIALED - dialed. The subscriber enters the CIC when dialing a call.
	STOPRTMR	Y or N	<p>Stop remote timer. Enter Y to disable the address complete message (ACM) timer of the remote switch. The default value is N.</p>
	XLAID	FREE, GENERIC1, GENERIC2, or GENERIC3	<p>AMA translation identifier. If the entry in subfield OSEL is AMAXLAID, datafill this refinement. Enter the AMA translation identifier to be used against table AMAXLAID.</p>

ACHEAD (continued)**Field descriptions for conditional datafill (Sheet 15 of 15)**

Field	Subfield	Entry	Explanation and action
	XLASYS	AC, AM, CT, FA, FT, NSC, OFC, PX	<p>Translation system. If the entry in subfield OSEL is XLT, datafill this refinement. Enter the next translation system to use, as listed below, followed by a space, then datafill refinement XLANAME:</p> <ul style="list-style-type: none"> • AC (access) • AM (ambiguous) • CT (country) • FA (foreign area) • FT (utility) • NSC (number service code) • OFC (office) • PX (prefix) <p>Note: NIL is not a valid entry. NIL is used only to satisfy internal software functionality. NSC is not used in GL03.</p>
	XLANAME	alphanumeric (1 to 8 characters)	<p>Translation name. If the entry in subfield OSEL is XLT, datafill this refinement. Enter the translation name of the table within the XLASYS to which the call is routed.</p>

ACHEAD (continued)**XLASEL = DBQ**

If the entry in field XLASEL is DBQ, datafill the following refinements.

Field descriptions for conditional datafill (Sheet 1 of 2)

Field	Subfield	Entry	Explanation and action
	OPT	see subfield	Options. This field is a vector consisting of up to ten options. Each option consists of subfield OSEL, and refinements that depend on the entry in subfield OSEL. For each option, specify the option selector (OSEL), followed by a space, then the refinements, each separated by a space. The entry is concluded by a \$ and datafill continues with field DFOP.
	OSEL	MM, NSC, or PF	Option selector. The following options can be selected. Enter MM, followed by a space, and datafill refinements MIN and MAX, if the minimum and maximum dialed digits are known. Enter NSC, followed by a space, and datafill refinement NSCODE, if a number service code operation is to be performed on a call. Enter PF, followed by a space, and datafill refinement PFDIGS if there are prefix digits in the digit stream.
	MAX	0 to 30	Maximum digits. If the entry in subfield OSEL is MM, datafill this refinement. Enter the maximum number of digits expected. This value includes the digits used to index the current tuple and must also include the prefix digits specified in the current tuple.
	MIN	0 to 30	Minimum digits. If the entry in subfield OSEL is MM, datafill this refinement. Enter the minimum number of digits expected. This value includes the digits used to index the current tuple and must also include the prefix digits specified in the current tuple.

ACHEAD (continued)

Field descriptions for conditional datafill (Sheet 2 of 2)

Field	Subfield	Entry	Explanation and action
	NSCODE	AIN, 800P, E008, E800, MAP_HLR, MAP_MSC, MAP_VLR, PVN, MAPHLR, REPLDIGS, or VPN	<p>Number service code. If the entry in subfield OSEL is NSC, enter the required number service code for the operation to be performed on the call, as listed below:</p> <ul style="list-style-type: none"> • AIN (advanced intelligent network) • 800P (800+) • E008 (Enhanced 008) • E800 (Enhanced 800) • MAP_HLR (mobile application part home location register) • MAP_MSC (mobile application part mobile service switching center) • MAP_VLR (mobile application part visitor location register) • MAPHLR (appears only if the MAP Interworking to BTUP feature is on the switch) • PVN (private virtual network) • REPLDIGS (replace digits) • VPN (virtual private network)
	PFDIGS	0 to 24	<p>Number of prefix digits. If the entry in subfield OSEL is PF, datafill this refinement. Enter the number of prefix digits. If prefix digits are identified in a previous table, this number is added to the existing value. Prefix digits are not used to index any further translation tables and are not outpulsed, but they do remain stored in call detail records (CDR).</p>

ACHEAD (continued)**XLASEL = DMOD**

If the entry in subfield XLASEL is DMOD, datafill the following refinements.

Field descriptions for conditional datafill (Sheet 1 of 7)

Field	Subfield	Entry	Explanation and action
	OPT	see subfield	Options. This field is a vector consisting of up to ten options. Each option consists of subfield OSEL, and refinements that depend on the entry in subfield OSEL. For each option, specify the option selector (OSEL), followed by a space, and the refinements, each separated by a space. The entry is concluded by a \$ and datafill continues with field DFOP.
	OSEL	AFTER, CATRTE, CDNRTE, CGNDM, CONSUME, COODM, CPCRTE, DEL, EXTCIC, INSRT, PF, RBP, REPL, SETCDN, VPNREPL, VPNXLT, or XLT	<p>Option selector. The following options can be selected:</p> <p>Enter AFTER, followed by a space, and datafill refinement AFTER if a specific number of digits must be skipped before modifying the digit stream.</p> <p>Enter CATRTE to allow charge category routing in IBN translations.</p> <p>Enter CDNRTE to route using the called number name (CDNNAME) from table CDNCHAR. If the CDNNAME is present on the incoming call or is set by the SETCDN option, translation proceeds to table CDNUXLA.</p> <p>Enter CGNDM, followed by a space, and datafill refinements PREFXCLI and INSRTCLI to remove digits from the calling line identification (CLI) and insert a datafilled digit string of up to five digits in the prefix string. The total length of the CLI and the digit string can be up to 18 digits. A modified CLI and digit string greater than 18 digits routes the call to treatment.</p> <p>Enter CONSUME, followed by a space, and datafill refinement CONDIGS to specify the number of digits that are consumed during translation.</p>

ACHEAD (continued)

Field descriptions for conditional datafill (Sheet 2 of 7)

Field	Subfield	Entry	Explanation and action
			<p>Enter COODM, followed by a space, and datafill refinement SERVICE to replace the dialed emergency code by the emergency number stored in table LAC.</p> <p>Note: Option selector COODM must be combined with option XLT to guarantee that translation continues with the modified number. Selector COODM cannot be combined with any other option.</p> <p>Enter CPCRTE to route using the calling party category (CPCNAME) from table CPCCHAR. If the CPCNAME is present on the incoming call, translation proceeds to table CPCUXLA.</p> <p>Enter DEL, followed by a space, and datafill refinement DELDIGS. Further digits are accepted from the agent, and overlap outpulsing is not affected. Digits being deleted are processed before those being inserted.</p> <p>Enter EXTCIC, followed by a space, and enter data for refinements CICSIZE, SKIPDIGS, and SOURCE. The EXTCIC subfield is the external carrier identification code that indicates a long distance carrier in the global environment. This option is supported for TOPS calls.</p> <p>Enter INSRT, followed by a space, and datafill refinement INSRDIGS. Further digits are accepted from the agent, and overlap outpulsing is not affected. Digits being deleted are processed before those being inserted.</p> <p>Note: Digit insertion is done in the actual digit stream, and the changes are reflected in call detail records. Replacement and insertion cannot be datafilled in the same tuple. If both options are datafilled, the second option in the tuple is used.</p>

ACHEAD (continued)**Field descriptions for conditional datafill (Sheet 3 of 7)**

Field	Subfield	Entry	Explanation and action
			<p>Enter PF, followed by a space, and datafill refinement PFDIGS, if there are prefix digits in the digit stream.</p> <p>Enter RBP without refinements. The entry RBP is used when a call is to be marked as Ringback Price. The RBP entry in table ACCODE suffixes a hexadecimal E to the calling digits for a call that translates using a tuple with option RBP.</p> <p>Enter REPL and datafill refinement REPLDIGS. Overlap outpulsing is disabled, and all digits are collected before continuing.</p> <p>Note: Digit replacement occurs in the actual digit stream, and the changes are reflected in call detail records. Replacement and insertion cannot be datafilled in the same tuple. If both options are datafilled, the second option in the tuple is used.</p> <p>Enter SETCDN to trigger the setting of outgoing called party characteristics. This option assigns the called number name (CDNNAME) from table CDNCHAR to the call. If the CDNRTE option is subsequently encountered, the CDNNAME is used to route the call.</p> <p>You can use the SETCDN option to allow CDN routing when incoming agents such as DPNSS or BTUP are not available in table CDNCHAR.</p> <p>Enter VPNREPL to replace the called party digits with the VPN called party digits conveyed across the public network by the QSIG Feature Transparency mechanism.</p>

ACHEAD (continued)

Field descriptions for conditional datafill (Sheet 4 of 7)

Field	Subfield	Entry	Explanation and action
			<p>Enter VPNXLT to replace the current translation system and translation name with the values stored in table BGIDMAP. The entry to table BGIDMAP is addressed by the NNI BGID and SIGNIFICANCE information received in the originating signaling for the call.</p> <p>Note: The VPNXLT and XLT options must not both exist in the same tuple.</p> <p>Enter XLT, followed by a space, and datafill refinement XLASYS if the call proceeds to another translation system.</p>
	AFTER	0 to 29	<p>After. If the entry in subfield OSEL is AFTER, datafill this refinement. Enter the number of digits to skip before doing the modification. The default case is to calculate the new prefix fence, and replace, insert, or delete digits after the fence (for example, starting at the next digit). Option AFTER is an additional number of digits to skip before doing the modification. Option AFTER refers to the option datafilled immediately before it. For example:</p> <p>>DMOD DEL 3 AFTER 2 INSRT 11</p> <p>skips two digits, deletes the next three, and inserts digits 11 at the beginning of the digit string. The result when applied to 234567 is 23117.</p> <p>Note: Datafilling this refinement with 0 (the default value), displays the following error message:</p> <pre>Too few digits for AFTER UNSUPPORTED OPTION AT: # PROCESSING ERROR UNEXPECTED ERROR CONDITION</pre>
	CATRTE	CATRTE	<p>Enter CATRTE to allow charge category routing in IBN translations.</p>

ACHEAD (continued)**Field descriptions for conditional datafill (Sheet 5 of 7)**

Field	Subfield	Entry	Explanation and action
	CDNNAME	alphanumeric string	Called number name. If the entry in subfield OSEL is SETCDN, enter data for this refinement. Enter data for this refinement to
	CICSIZE	1 to 4	CIC size. If the entry in subfield OSEL is EXTCIC, enter data for this refinement. This field indicates the number of digits in the CIC. This field operates on the B (called) number, so it is assumed that the switch signals the CIC as part of the B number. The MAP display indicates the range is 0 to 4. The system does not allow a 0 entry.
	CONDIGS	numeric (0 to 29 digits)	Consumed digits. If the entry in subfield OSEL is CONSUME, datafill this refinement. Enter a number to explicitly define the number of digits consumed during call processing.
	DELDIGS	0 to 29	Delete digits. If the entry in subfield OSEL is DEL, datafill this refinement. Enter the number of digits to be deleted, after skipping digits to be left unprocessed.
	INSRDIGS	0 to 29 digits	Insert digits. If the entry in subfield OSEL is INSRT, datafill this refinement. Enter the digits to be inserted, after skipping digits to be left unprocessed.
	INSRTCLI	1 to 5 digits or \$	Insert calling line identification. If the entry in subfield OSEL is CGNDM, datafill this refinement. Enter the new string to insert as the prefix onto the CLI. Enter \$ to specify that no digit string is inserted.

ACHEAD (continued)**Field descriptions for conditional datafill (Sheet 6 of 7)**

Field	Subfield	Entry	Explanation and action
	PFDIGS	0 to 24	<p>Number of prefix digits. If the entry in subfield OSEL is PF, datafill this refinement. Enter the number of prefix digits. If prefix digits are identified in a previous table, this number is added to the existing value. Prefix digits are not used to index any further translation tables and are not outpulsed, but they do remain stored in call detail records (CDR).</p> <p>Note: If refinements PF and CONSUME are both datafilled for the same tuple, only the entry for the greater of the two values is processed; the other entry is ignored.</p>
	PREFXCLI	0 to 18	<p>Prefix calling line identification. If the entry in subfield OSEL is CGNDM, datafill this refinement. Enter the number of prefix digits to delete.</p>
	REPLDIGS	numeric (0 to 30 digits)	<p>Replace digits. If the entry in subfield OSEL is REPL, datafill this refinement. Enter the digits that replace the existing digits, after skipping digits to be left unprocessed.</p>
	SERVICE	alphanumeric (1 to 8 characters)	<p>COODM service. If the entry in subfield OSEL is COODM, datafill this refinement. Enter the emergency service name. Emergency service names are listed in field EMRGSERV in table LAC.</p>
	SKIPDIGS	0 to 24	<p>Skip digits. If the entry in subfield OSEL is EXTCIC, enter data for this refinement. This field indicates the number of digits to skip before removing the carrier digits from the digit stream. This field operates on the B (called) number, so it is assumed that the system signals the CIC as part of the B number.</p>

ACHEAD (continued)**Field descriptions for conditional datafill (Sheet 7 of 7)**

Field	Subfield	Entry	Explanation and action
	SOURCE	PRESUB or DIALED	<p>Carrier identification code source. If the entry in subfield OSEL is EXTCIC, enter data for this refinement. This field specifies the source of the CIC as follows:</p> <ul style="list-style-type: none"> • PRESUB - presubscribed. Table TRKGRP contains the definition of the CIC. • DIALED - dialed. The subscriber enters the CIC when dialing a call.
	XLASYS	AC, AM, CT, FA, FT, NSC, OFC, or PX	<p>Translation system. If the entry in subfield OSEL is XLT, datafill this refinement. Enter the next translation system to use, followed by a space, and datafill subfield XLANAME (the instance of the translation system).</p> <p>The choice of translation systems is as follows:</p> <ul style="list-style-type: none"> • AC (access) • AM (ambiguous) • CT (country) • FA (foreign area) • FT (utility) • NSC (number service code) • OFC (office) • PX (prefix) <p>Note: NIL is not a valid entry. NIL is used only to satisfy internal software functionality. NSC is not used in GL03.</p>
	XLANAME	alphanumeric (1 to 8 characters)	<p>Translation name. If the entry in subfield OSEL is XLT, datafill this refinement. Enter the translation name of the table within the XLASYS to which the call is routed.</p>

XLASEL = DNRTE

If the entry in subfield XLASEL is DNRTE, datafill the following refinements. Selector DNRTE allows translation to continue in table DNETINV. Through

ACHEAD (continued)

this translation, calls can be terminated at directory numbers (DN) datafilled in table DNINV.

After datafilling table ACHEAD, table DNINV must be datafilled before selector DNRTE is datafilled in table ACCODE.

Table AMAXLAID must be datafilled prior to selecting option AMAXLAID in field OSEL.

Field descriptions for conditional datafill (Sheet 1 of 4)

Field	Subfield	Entry	Explanation and action
	OPT	see subfield	Options. This field is a vector consisting of a maximum of ten options. Each option consists of subfield OSEL, and refinements that depend on the entry in subfield OSEL. For each option, specify the option selector (OSEL), followed by a space, and the refinements, each separated by a space. The entry is concluded by a \$ and datafill continues with field DFOP.
	OSEL	ALLOWOVLP, AMAXLAID, CAMA, CLASS, DN, MM, PF, or SF	<p>Option selector. The following options can be selected.</p> <p>Enter ALLOWOVLP to allow overlap. This subfield does not have refinements.</p> <p>Enter AMAXLAID, followed by a space, and datafill refinement XLAID to specify an automatic message accounting (AMA) identity from within table AMAXLAID.</p> <p>Enter CAMA, followed by a space, and datafill refinement CLDFMT. The entry in CLDFMT indicates whether the international centralized AMA (ICAMA) record is generated with the originally signaled DN or the final public switched telephone network (PSTN) number.</p>

ACHEAD (continued)**Field descriptions for conditional datafill (Sheet 2 of 4)**

Field	Subfield	Entry	Explanation and action
	CLDFMT	CURRENT, POSTXLA	<p>Enter CLASS, followed by a space, and datafill refinement CLASS if the class of the dialed digits is determined.</p> <p>Enter DN, followed by a space, and datafill refinements SNPA and OFC for the DN that the call is routed to.</p> <p>Enter MM, followed by a space, and datafill refinements MIN and MAX if the minimum and maximum dialed digits are known.</p> <p>Enter PF, followed by a space, and datafill refinement PFDIGS if there are prefix digits in the digit stream.</p> <p>Enter SF, followed by a space, and datafill refinement SFDIGS to indicate the beginning of the station code digits.</p> <p>Called format. If the entry in subfield OSEL is CAMA, enter either CURRENT or POSTXLA to produce the required ICAMA record format.</p> <p>If the entry is CURRENT, an ICAMA record is produced with the signaled DN (without translation).</p> <p>If the entry is POSTXLA, an ICAMA record is produced with the public switched telephone network (PSTN) number resulting from translations.</p>

ACHEAD (continued)**Field descriptions for conditional datafill (Sheet 3 of 4)**

Field	Subfield	Entry	Explanation and action
	CLASS	ATT, CNTL, DATT, EMRG, IAGRP, ICNTL, INTL, IOPRA, LCL, NATL, OPRA, RURAL, SPEC, UNKW, or URBAN	<p>Translation class. If the entry in subfield OSEL is CLASS, datafill this refinement. Enter the translation class determined by the dialed digits. This can be used for screening or billing purposes as described under CLASS in screening and charging options.</p> <ul style="list-style-type: none"> • ATT (attendant console) • CNTL (continental) • DATT (dial attendant) • EMRG (emergency) • IAGRP (interagent group) • ICNTL (intercontinental) • INTL (international) • IOPRA (international operator assisted) • LCL (local) • NATL (national) • OPRA (operator assisted) • RURAL (rural) • SPEC (special) • UNKW (unknown) • URBAN (urban)
	MAX	0 to 30	<p>Maximum digits. If the entry in subfield OSEL is MM, datafill this refinement. Enter the maximum number of digits expected. This value includes the digits used to index the current tuple and must also include the prefix digits specified in the current tuple.</p>
	MIN	0 to 30	<p>Minimum digits. If the entry in subfield OSEL is MM, datafill this refinement. Enter the minimum number of digits expected. This value includes the digits used to index the current tuple and must also include the prefix digits specified in the current tuple.</p>

ACHEAD (continued)**Field descriptions for conditional datafill (Sheet 4 of 4)**

Field	Subfield	Entry	Explanation and action
	OFC	numeric (1 to 7 digits)	Seven-digit office code. If the entry in subfield OSEL is DN, enter the office code for the DN that the call is routed to.
	PFDIGS	0 to 24	Number of prefix digits. If the entry in subfield OSEL is PF, datafill this refinement. Enter the number of prefix digits. If prefix digits are identified in a previous table, this number is added to the existing value. Prefix digits are not used to index any further translation tables and are not outpulsed, but they do remain stored in call detail records (CDR).
	SFDIGS	0 to 29	Station fence digits. If the entry in subfield OSEL is SF, datafill this refinement. Enter a number to indicate how many digits to advance past the start of the digits that index into the tuple. During call processing, the station code digits consist of all digits beyond this indicator to the end of the dialed digits. If option SF is not datafilled, the last four digits comprise the station code.
	SNPA	000 to 999 (3 digits)	Serving number plan area. If the entry in subfield OSEL is DN, enter the required serving number plan area (SNPA). This number must be datafilled in table HNPACONT or in table SNPANAME.
	XLAID	FREE, GENERIC1, GENERIC2, or GENERIC3	AMA translation identifier. If the entry in subfield OSEL is AMAXLAID, enter the AMA translation identifier to be used against table AMAXLAID.

ACHEAD (continued)

XLASEL = FEAT

If the entry in field XLASEL is FEAT, datafill the following refinements.

Field descriptions for conditional datafill (Sheet 1 of 3)

Field	Subfield	Entry	Explanation and action
	OPT	see subfield	Options. This field is a vector consisting of up to ten options. Each option consists of subfield OSEL, and refinements that depend on the entry in subfield OSEL. For each option, specify the option selector (OSEL), followed by a space, and the refinements, each separated by a space. The entry is concluded by a \$ and datafill continues with field DFOP.
	OSEL	FTR, FUNC, MM, PF, or XLT	<p>Option selector. The following options can be selected.</p> <p>Enter FTR, followed by a space, and datafill refinement VSC to indicate the international line feature needs translation in table XLA.</p> <p>Enter FUNC, followed by a space, and datafill refinement FUNC to identify the international line feature function.</p> <p>Enter MM, followed by a space, and datafill refinements MIN and MAX if the minimum and maximum dialed digits are known.</p> <p>Enter PF, followed by a space, and datafill refinement PFDIGS if there are prefix digits in the digit stream.</p> <p>Enter XLT, followed by a space, and datafill refinement XLANAME if the translation name of the translation system is known.</p>

ACHEAD (continued)**Field descriptions for conditional datafill (Sheet 2 of 3)**

Field	Subfield	Entry	Explanation and action
	FTR	CALLBACK, CALLCHAR, CLCTDIGS, JES, NTC, VMWI, VSC or VALIDATE	<p>Feature name. If the entry in subfield OSEL is FTR, enter the refinement name shown below:</p> <ul style="list-style-type: none"> • CALLBACK (call back) • CALLCHAR (call characters) • CLCTDIGS (collect digits) • JES (Japan emergency services) • NTC (Notify Time Charges) • TLC (trunk logic circuit) • VMWI (voice mail waiting indication) • VSC (vertical service code) • VALIDATE (not used in GL03)
	FUNC	ACT, DEACT, DELETE, INTER, PROG, or USAGE	<p>Feature function code. If subfield OSEL is set to FUNC, enter one of the international line feature function codes listed below:</p> <ul style="list-style-type: none"> • ACT (activate) • DEACT (deactivate) • DELETE (delete) • INTER (interrogate) • PROG (programming) • USAGE (usage)
	MAX	0 to 30	<p>Maximum digits. If the entry in subfield OSEL is MM, datafill this refinement. Enter the maximum number of digits expected following MIN entry and a space. This value includes the digits used to index the current tuple and must also include the prefix digits specified in the current tuple.</p>

ACHEAD (continued)**Field descriptions for conditional datafill (Sheet 3 of 3)**

Field	Subfield	Entry	Explanation and action
	MIN	0 to 30	Minimum digits. If the entry in subfield OSEL is MM, datafill this refinement. Enter the minimum number of digits expected. This value includes the digits used to index the current tuple and must also include the prefix digits specified in the current tuple.
	PFDIGS	0 to 24	Number of prefix digits . If the entry in subfield OSEL is PF, datafill this refinement. Enter the number of prefix digits. If prefix digits are identified in a previous table, this number is added to the existing value. Prefix digits are not used to index any further translation tables and are not outputted, but they remain stored in call detail records (CDR).

XLASEL = FEATINFO

If the entry in subfield XLASEL is FEATINFO, datafill the following refinements. Selector FEATINFO makes use of table DNSCRN to store information against DNs, which is used during call processing to determine how to proceed with the call. The screening function is triggered by selector FEATINFO in the universal translation tables. The options available with this selector are shown below.

Field descriptions for conditional datafill (Sheet 1 of 9)

Field	Subfield	Entry	Explanation and action
	FTR	CALLBACK, CALLCHAR, CLCTDIGS, JES, NTC, TLC, or VALIDATE	Feature name. Enter CALLBACK to enable originator callback during translations. Datafill subfield CALLBACK_OPTION and its refinements, then datafill subfields PFDIGS, MINDIGS, MAXDIGS, and TABREF. Enter CALLCHAR to modify all signaling characteristics. Datafill subfields CLLCHROP, PFDIGS, MINDIGS, MAXDIGS, and TABREF.

ACHEAD (continued)**Field descriptions for conditional datafill (Sheet 2 of 9)**

Field	Subfield	Entry	Explanation and action
			<p>Enter CLCTDIGS to collect digits from the call originator and add them to the called digits stream for translation. Datafill subfields CLDGMIN, CLDGMAX, CLCTDIGS_OPTION, PFDIGS, MINDIGS, MAXDIGS, and TABREF.</p> <p>Enter JES to activate the Japan Emergency Service feature. Datafill refinements PFDIGS and TABREF.</p> <p>Enter NTC to notify the originating subscriber of applicable time and charges after the call terminates. Datafill subfield SUBOPT_NAME and its refinement, then datafill subfields PFDIGS, MINDIGS, MAXDIGS, and TABREF.</p> <p>Enter TLC to enable the test line call feature, which provides audible ringback tone followed by dial tone after specified durations. Datafill subfields RING_BACK_TONE_DUR, DIAL_TONE_DUR, TLC_PREFIX_DIGS, , TLC_NUM_DIGS, and TLC_CHARGE.</p> <p>Enter VALIDATE, and datafill subfield VALADTOP and its refinements. Datafill subfields PFDIGS, MINDIGS, MAXDIGS, and TABREF.</p>
	CALLBACK_OPTION	CLCTDEST or NIL	<p>Callback option. If the entry in field FTR is CALLBACK, datafill this option. Enter CLCTDEST to call back the subscriber and collect destination digits. Datafill subfields CLDGMIN, CLDGMAX, DISC_ANNC_TRK, PROMPT_ANNC_TRK, and SEND_ANM. Otherwise, enter NIL.</p>
	CLDGMIN	1 to 24	<p>Minimum collected digits. Enter the minimum number of digits to be collected and entered into the called digit stream.</p>
	CLDGMAX	1 to 24	<p>Maximum collected digits. Enter maximum number of digits to be collected and written into the called digit stream. The value cannot be less than CLDGMIN.</p>

ACHEAD (continued)**Field descriptions for conditional datafill (Sheet 3 of 9)**

Field	Subfield	Entry	Explanation and action
	DISC_ANNC_TRK	alphanumeric (1 to 16 characters)	Disconnect announcement trunk. Enter trunk common language location identifier (CLLI).
	PROMPT_ANNC_TRK	alphanumeric (1 to 16 characters)	Prompt announcement trunk. Enter trunk the common language location identifier (CLLI).
	SEND_ANM	Y or N	Send answer message. Enter Y (yes) or N (no).
	CLLCHROP	NOCHGMSG or EARLYCPG	Call characteristics. If the entry in field FTR is CALLCHAR, datafill this option. Enter NOCHGMSG to block backward CHG message. Enter EARLYCPG to specify that a call progress (CPG) message is issued in the backwards direction before an address complete message (ACM) is sent. The CPG message is permitted before an ACM in certain ISDN user part (ISUP) variants to establish a bidirectional speech path and to stop the T7 timer.
	CLCTDIGS_OPTION	NIL or \$	Collect digits option. If the entry in field FTR is CLCTDIGS, datafill this option. Enter NIL or enter \$ to proceed to the next option.
	SUBOPT_NAME	DUR_ADJ	Suboption name. If the entry in field FTR is NTC, datafill this option. Enter DUR_ADJ to specify the duration adjustment for NTC and datafill subfield DURATION_ADJ.
	DURATION_ADJ	0 to 99	Duration adjustment. Enter the time in seconds.
	RING_BACK_TONE_DUR	1 to 255	Ringback tone duration. If the entry in field FTR is TLC, datafill this option. Enter the time, in seconds, that ringback tone is provided to the originator.
	DIAL_TONE_DUR	1 to 255	Dial tone duration. If the entry in field FTR is TLC, datafill this option. Enter the time, in seconds, that dial tone is provided to the originator.

ACHEAD (continued)**Field descriptions for conditional datafill (Sheet 4 of 9)**

Field	Subfield	Entry	Explanation and action
	TLC_PREFIX_ DIGS	0 to 18	Prefix digits in called number. If the entry in field FTR is TLC, datafill this option. Enter the number of digits to advance the prefix fence to detect the charge message digits when CPC = PAYPHONE.
	TLC_NUM_ DIGS	numeric (3 or 4) Japan only	Test line call number of digits. Enter the number of dialed digits to be transferred to the NCCI#7 CHG message. This is also the number of digits stored in the LMNNUM field of the SMDR #DE record.
	TLC_CHARGE	Y or N	Test line call charge indicator. The TLC_CHARGE field indicates the billing status of an ISUP test call. Enter Y if the call is billable. Enter N if the call is not billable. The default value for this field is N.
	OPT	see subfield VALDATOP	Options. If the entry in field FTR is VALIDATE, datafill this option. This field is a vector consisting of up to five options. Each option consists of subfield VALDATOP, and refinements that depend on the entry in subfield VALDATOP. For each option, specify VALDATOP, followed by a space, then the refinements, each separated by a space. The entry is concluded by a \$ and datafill continues with field DFOP.
	VALDATOP	BCSCRN, CALLED, CLDTCCLG, CLISERV, CUSTMOD, LCASCRN, NOCHARGE, PRESEL, SCRNLNTH, SUBSCRN, TCNOTSCR, THIRDPTY, VERDEST, V3PTYBIL	Validate option. Enter a list of up to five options. The options specify what characteristics are to be considered when screening the call. Enter \$ to signify the end of the list. Note: Selector VALIDATE is traversed only once for each call. Enter BCSCRN and datafill refinement BCOPTS to identify the bearer capability name.

ACHEAD (continued)

Field descriptions for conditional datafill (Sheet 5 of 9)

Field	Subfield	Entry	Explanation and action
			<p>Enter CALLED to indicate the number to be used for screening. The SUBSCRN options are used to specify the subscriber types allowed to receive the call.</p> <p>Note: When using option CALLED, there must be no further digit manipulation after selector VALIDATE is encountered in translations.</p> <p>If option CALLED is not entered, then the calling party number is used for screening and the SUBSCRN options are used to specify the subscriber types allowed to make the call.</p> <p>Note: Pay phone subscribers are treated as general subscribers if option CALLED is specified.</p> <p>Enter CLDTCOLG, followed by a space, to copy digits from the called to the calling digit stream, and datafill options OFFSET and COUNT.</p> <p>Enter CLISERV, followed by a space, and enter data for refinement SERVNAME to add the name of the service provider.</p> <p>Enter CUSTMOD, followed by a space, to alter the internal network class of service (NCOS) and customer group to new value for a given directory number (DN) based on the CUSTINFO attribute in table DNSCRN. The source of the DN used as an index into table DNSCRN is determined by the VALIDATE datafill. Datafill refinement CUSTSCRN.</p> <p>Enter LCASCRN, followed by a space, to enable local calling area screening. The called and calling numbers are checked against tables LCARNAME and LCASCRN to determine if the numbers are local to each other, and whether the call should be denied or allowed to continue routing.</p>

ACHEAD (continued)

Field descriptions for conditional datafill (Sheet 6 of 9)

Field	Subfield	Entry	Explanation and action
			<p>Enter NOCHARGE, followed by a space, to indicate that the call is nonbillable.</p> <p>Note: If both NOCHARGE and THIRDPPTY options are specified, NOCHARGE takes precedence.</p> <p>Enter PRESEL to allow screening for the PRESEL attribute in table DNSCRN.</p> <p>Enter SCRNLNTH, followed by a space, and datafill refinement MINLNTH to specify the minimum length of the number being screened.</p> <p>Enter SUBSCRN, followed by a space, and datafill up to three multiples of the following subscriber types: GENERAL, PAYPHONE, PERSONAL, and MOBILE. Enter \$ after entering SUBSCRN to indicate that no subscriber types are permitted to make or receive the call.</p> <p>Enter TCNOTSCR to indicate that calls with CPC set to Test Call are not screened.</p> <p>Enter THIRDPPTY to indicate that automatic third party billing is used. Table DNSCRN is checked for attribute UNPAID.</p> <p>Note: If both NOCHARGE and THIRDPPTY options are specified, NOCHARGE takes precedence.</p> <p>Note: Payphone subscribers are treated as general subscribers if option CALLED is specified.</p> <p>Enter VERDEST to verify the destination of a call. Called digits are checked against ADDCODE entries in table DNSCRN.</p> <p>Note: NIL appears on the switch range but is not a valid entry. The value NIL is used only to satisfy internal software requirements.</p>

ACHEAD (continued)

Field descriptions for conditional datafill (Sheet 7 of 9)

Field	Subfield	Entry	Explanation and action
	BCOPTS	alphanumeric (1 to 8 characters)	Bearer capability option. If the entry in field VALDATOP is BCSCRN, datafill this refinement. Enter up to four bearer capability names.
	COUNT	0 to 30	If the entry in field VALDATOP is CLDTCCLG, enter subfield COUNT to count the digits from the called stream to the calling stream.
	CUSTSCRN	Y or N	Customer screen. Enter Y to block calls that are not subscribed to the switched on-net services if attempting a switched on-net call. If the DN being screened is not present in table DNSCRN, the call is rejected with the Call Not Allowed (CNAD) treatment. The internal NCOS and CUSTGRP associated with the call are altered to the values found in the CUSTINFO attribute if present for the given DN in table DNSCRN. The DN used to index table DNSCRN can be the subscriber calling line identification (CLI) or the dialed number. The source of the DN is determined by the datafill of field VALIDATE. Enter N if no screening is performed.
<p>Note: The FEATINFO values CCANN, CCARD, CCSDT, DFOP, FAXSUP, FAXTEST, INBFAX, INBFD, INTLFD, ISD, ISDTST, ISDVRE, OUTBFAX, OUTBFD, PB3RDPTY, PBCALL, PBISD, PBISDVRE, and PBTST are valid only in DMS-250 switching offices. Additional DMS-250 parameters are listed in the DMS-250 specific data schema NTPs.</p>			
	MINLNTH	0 to 18 values from 0 to 30 are possible in APC software loads	Minimum length. If the entry in field VALDATOP is SCRNLNTH, enter the minimum number of digits required in number being screened.
	OFFSET	0 to 30	If the entry in field VALDATOP is CLDTCCLG, enter subfield OFFSET to offset the digits from the called stream to the calling stream.
	SERVNAME	alphanumeric string	Service provider name. If the entry in field VALDATOP is CLISERV, enter the name of the service provider in this refinement.

ACHEAD (continued)**Field descriptions for conditional datafill (Sheet 8 of 9)**

Field	Subfield	Entry	Explanation and action
	SUBSCTYP	GENERAL, PAYPHONE, PERSONAL, or MOBILE	Subscriber type. Enter subscriber type, followed by a space, and datafill refinements WHITLIST, CHKBLKCL, CHKUNPD, and CHKCCR. This option allows you to specify which subscriber types are permitted to make or receive a call and whether the subscriber's standing is important for a call.
	WHITLIST	Y or N	Whether it list. Enter Y (yes) to indicate that the subscriber's directory number must be datafilled in table DNSCRN. Otherwise, enter N (no).
	CHKBLKCL	Y or N	Check block call. Enter Y to check if the subscriber has subscribed to all services for which this tuple is being used (BLKCALL attribute in table DNSCRN). Otherwise, enter N.
	CHKUNPD	Y or N	Check unpaid. Enter Y to check if the subscriber has paid his bills. Otherwise, enter N.
	CHKCCR	Y or N	Check cumulative call restriction. Enter Y to check the subscriber's cumulative charge limit. Otherwise, enter N.
	PFDIGS	0 to 24	Prefix digits. Enter the number of prefix digits present at this point in the call. Prefix digits are not used to index any further translation tables and are not outpulsed, but they remain stored in call detail records (CDR).
	MINDIGS	0 to 30	Minimum digits. Enter the minimum number of digits expected. This value includes the digits used to index the current tuple and must also include the prefix digits specified in the current tuple.
	MAXDIGS	0 to 30	Maximum digits. Enter the maximum number of digits expected. This value includes the digits used to index the current tuple and must also include the prefix digits specified in the current tuple.

ACHEAD (continued)**Field descriptions for conditional datafill (Sheet 9 of 9)**

Field	Subfield	Entry	Explanation and action
	TABREF	see subfields	Table reference. This field consists of subfields XLASYS and XLANAME.
	XLASYS	AC, AM, CT, FA, FT, NSC, OFC, or PX	<p>Translation system. Enter the next translation system to use, followed by a space, and datafill subfield XLANAME (the instance of the translation system).</p> <p>The choice of translation systems is as follows:</p> <ul style="list-style-type: none"> • AC (access) • AM (ambiguous) • CT (country) • FA (foreign area) • FT (utility) • NSC (number service code) • OFC (office) • PX (prefix) <p>Note: NIL is not a valid entry. NIL is used only to satisfy internal software functionality.</p>
	XLANAME	alphanumeric (1 to 8 characters)	Translation name. Enter the translation name of the table instance within the XLASYS to which the call is routed.

ACHEAD (continued)**XLASEL = HRC**

If the entry in subfield XLASEL is HRC, datafill the following refinements.

Field descriptions for conditional datafill (Sheet 1 of 2)

Field	Subfield	Entry	Explanation and action
	OPT	see subfield	Options. This field contains subfield OSEL, and refinements that depend on the entry in subfield OSEL. The entry is concluded by a \$ and datafill continues with field DFOP.
	OSEL	PFBILL, XLT	Option selector. If the call proceeds to another translation system, enter XLT, followed by a space, and datafill refinement XLASYS. Also complete an entry for option selector PFBILL.
	XLASYS	AC, AM, CT, FA, FT, NSC, OFC, PX	<p>Translation system. If option selector XLT is entered in subfield OSEL, datafill this refinement. Enter the next translation system to use, followed by a space, then datafill refinement XLANAME. Enter one of the following:</p> <ul style="list-style-type: none"> • AC (access) • AM (ambiguous) • CT (country) • FA (foreign area) • FT (utility) • NSC (number service code) • OFC (office) • PX (prefix) <p>Note: NIL is not a valid entry. NIL is used only to satisfy internal software functionality. NSC is not used in GL03.</p>

ACHEAD (continued)**Field descriptions for conditional datafill (Sheet 2 of 2)**

Field	Subfield	Entry	Explanation and action
	XLANAME	alphanumeric (1 to 8 characters)	Translation name. If XLT is entered in subfield OSEL, datafill this refinement. Enter the translation name of the table within the XLASYS to which the call is routed.
	PFBILL	Y or N	Prefix billing option. Enter PFBILL, followed by a space, and then enter either Y or N. If "Y" is entered, the home routing code specified in the tuple is included in the billing record. If "N" is entered, the home routing code is not included in billing records.

XLASEL = IAC

If the entry in subfield XLASEL is IAC, datafill the following refinements.

Field descriptions for conditional datafill

Field	Subfield	Entry	Explanation and action
	OPT	see subfield	Options. This field is a vector list consisting of up to ten options. Each option consists of subfield OSEL, and refinements that depend on the entry in subfield OSEL. The entry is concluded by a \$ and datafill continues with field DFOP.
	OSEL	PF	Option selector. Enter PF, followed by a space, and datafill refinement PFDIGS, if there are prefix digits in the digit stream.
	PFDIGS	0 to 24	Number of prefix digits. If the entry in subfield OSEL is PF, datafill this refinement. Enter the number of prefix digits. If prefix digits are identified in a previous table, this number is added to the existing value. Prefix digits are not used to index any further translation tables and are not outputted, but they remain stored in call detail records (CDR).

XLASEL = RTE

If the entry in subfield XLASEL is RTE, datafill the following refinements.

ACHEAD (continued)

Table AMAXLAID must be datafilled prior to selecting option AMAXLAID in field OSEL.

Field descriptions for conditional datafill (Sheet 1 of 15)

Field	Subfield	Entry	Explanation and action
	OPT	see subfield	Options. This field is a vector consisting of a maximum of ten options. Each option consists of subfield OSEL, and refinements that depend on the entry in subfield OSEL. For each option, specify the option selector (OSEL), followed by a space, and the refinements, each separated by a space. The entry is concluded by a \$ and datafill continues with field DFOP.
	OSEL	ACF, AMAXLAID, BLKOVLP, CALLCTRL, CAMA, CATRTE, CDN, CDNRTE, CHGIND, CLASS, CONSUME, CPCRTE, CPMCALL, DDIDX, DEST, DFT EXTCIC, IAA, LNET, MM, MZONE, NETSRV, NICRF, NOANSTIM, PCC, PF, PIP, PNRF, PRESEL, PRESELRTE PRIVL, QFT, SETCDN, TOC, VPN, or VPNPAN	Option selector. Enter ACF, followed by a space, and datafill refinement ACF, if the area code fence is defined. Enter AMAXLAID, followed by a space, and datafill refinement XLAID, to specify an automatic message accounting (AMA) identity from within table AMAXLAID. Enter BLKOVLP to prevent calls from being outpulsed until all CDN digits are collected. This subfield does not have refinements. Enter CALLCTRL, followed by a space, and datafill refinement CALLCTRL. The entry in refinement CALLCTRL indicates who has control of the call: the calling party, the called party, or both.

ACHEAD (continued)

Field descriptions for conditional datafill (Sheet 2 of 15)

Field	Subfield	Entry	Explanation and action
			<p>Enter CAMA, followed by a space, and datafill refinement CLDFMT. The entry in refinement CLDFMT indicates whether the international centralized automatic message accounting (ICAMA) record is generated with either the originally signaled directory number (DN) or the final public switched telephone network (PSTN) number.</p> <p>Enter CATRTE to allow charge category routing in IBN translations.</p> <p>Enter CDN, followed by a space, and datafill refinement CDN to select the nature of address field. This field is used to identify the called party of the initial address message (IAM). It is used for Australian ISDN user part (AISUP) call translations.</p> <p>Enter CDN RTE to route using the called number name (CDNNAME) from table CDNCHAR. If the CDNNAME is present on the incoming call or is set by the SETCDN option, translation proceeds to table CDNUXLA.</p> <p>CHGIND indicates whether to override the value of the charge indicator in the Backward Call indicators. The CHGIND option applies only to JCTV loads.</p> <p>Enter CLASS, followed by a space, and datafill refinement CLASS, if the class of the dialed digits is determined.</p> <p>Enter CONSUME, followed by a space, and datafill refinement CONDIGS, to specify the number of digits that are consumed during translation.</p> <p>Enter CPC RTE to route using the calling party category (CPCNAME) from table CPCCHAR. If the CPCNAME is present on the incoming call, translation proceeds to table CPCUXLA.</p>

ACHEAD (continued)**Field descriptions for conditional datafill (Sheet 3 of 15)**

Field	Subfield	Entry	Explanation and action
			<p>Enter CPMCALL, followed by a space, and datafill refinement CPMCALL, to specify call billing against the called party instead of the calling party for intraoffice calls.</p>
			<p>Enter DDIDX, followed by a space, and enter data for refinement DDIDX. Enter data for this subfield if a destination discount applies to the call.</p>
			<p>Enter DEST, followed by a space, and datafill refinement DEST, the index into the route table of the current XLASYS and XLANAME.</p>
			<p>Enter DFT for DPNSS feature transparency functionality.</p>
			<p>Enter EXTCIC, followed by a space, and enter data for refinements CICSIZE, SKIPDIGS, and SOURCE. This subfield indicates the external carrier identification code.</p>
			<p>Enter IAA and the datafill refinement IAA_INDEX to generate or modify IAA message parameters based on datafill in table IAACtrl.</p>
			<p>Enter LNET, followed by a space, and datafill refinement LNET, the index into table LNETWORK, to find the international metering system tariff for the call.</p>

ACHEAD (continued)

Field descriptions for conditional datafill (Sheet 4 of 15)

Field	Subfield	Entry	Explanation and action
			<p>Enter MM, followed by a space, and datafill refinements MIN and MAX, if the minimum and maximum number of expected digits dialed are known. These values include the digits used to index the current tuple and must also include the prefix digits specified in the current tuple.</p> <p>Note: For fast interdigital timing to function properly, MM can only be used with the RTE selector whenever the value in refinement MIN is not equal to the value in refinement MAX. In other words, if MIN=MAX, MM can be used with the CONT selector in table PXCORE; if the value in refinement MIN is not equal to the value in refinement MAX, MM cannot be used until the RTE selector is used (which is usually in either table FACODE or table OFCCODE). If refinements MIN and MAX are set in table PXCORE when they are not equal to each other, partial dial timing is used after MIN digits are dialed in order to determine the end of dialing.</p> <p>Enter MZONE, followed by a space, and datafill refinement MZONE, if metering is done on the call.</p> <p>Enter NETSRV and datafill refinement NETSRV_NAME to indicate a Japan network service.</p> <p>Enter NICRF to activate the Network Identification Code (NIC) routing function.</p> <p>Enter NOANSTIM to the CONT selectors. This turns the T9 timer off in the outgoing ISUP trunk, if encountered.</p> <p>Enter PCC, followed by a space, and datafill refinement PCCDR, if a pseudo country code is required.</p>

ACHEAD (continued)**Field descriptions for conditional datafill (Sheet 5 of 15)**

Field	Subfield	Entry	Explanation and action
			<p>Enter PF, followed by a space, and datafill refinement PFDIGS, the prefix fence. This is the number of prefix digits associated with this tuple (that is, if some prefix digits were identified in a previous table, the number here is added to the existing value). Prefix digits are not used to index any further translation tables and are not outpulsed, but they remain stored in call detail records (CDR).</p> <p>Enter PIP, followed by a space, to perform a residency check for the digits being translated. The residency check is used by the local number portability feature to ensure that calls to DNs that have been ported into the office are not routed out of the office.</p> <p>Note: You must complete entries in fields MIN and MAX before entering the PIP option.</p> <p>Enter PNRF to invoke the ported number recognition function.</p> <p>Enter PORTED to indicate that a previous node detected the service number of this call to have been ported.</p> <p>Enter PRESEL, followed by a space, and datafill refinement PRESEL to provide the necessary information used to index into table PCIXLA.</p> <p>Enter PRESELRTE for the index into the route table of the current XLASYS and XLANAME. This subfield does not have refinements.</p> <p>Enter PRIVL, followed by a space, and datafill refinement PRIVL, if the user is a privileged user (for example, operators).</p>

ACHEAD (continued)

Field descriptions for conditional datafill (Sheet 6 of 15)

Field	Subfield	Entry	Explanation and action
			<p>Enter QFT followed by ON or OFF to indicate if an outgoing route is capable of QSIG Feature Transparency.</p> <p>Note: The QFT ON option must not be added to a route unless the far-end node is QFT-capable.</p> <p>Enter SETCDN to trigger the setting of outgoing called party characteristics. This option assigns the called number name (CDNNAME) from table CDNCHAR to the call. If the CDNRTE option is subsequently encountered, the CDNNAME is used to route the call.</p> <p>You can use the SETCDN option to allow CDN routing when incoming agents such as DPNSS or BTUP are not available in table CDNCHAR.</p> <p>Enter TOC, followed by a space, and datafill refinement CHG for the type of charge where the type of charge messaging is to be selected.</p> <p>Enter VPN, followed by a space, and datafill refinements ONNET and BILLABLE if the call routes through a service switching point (SSP) and the Australian VPN-SSP feature is present in the switch.</p> <p>Enter VPNPAN to indicate that the PINX is to act as the PAN for an outgoing route.</p> <p>Note: If VPNREPL or VPNXLT have been entered in the DMOD selector, the VPNPAN option is redundant.</p>
	ACF	0 to 29	<p>Area code fence. If the entry in subfield OSEL is ACF, datafill this refinement. Enter the number of digits between the beginning of the digits to currently index the table, and the end of the area code.</p>

ACHEAD (continued)**Field descriptions for conditional datafill (Sheet 7 of 15)**

Field	Subfield	Entry	Explanation and action
	BILLABLE	Y or N	<p>Virtual private network billable call. If the entry in subfield OSEL is VPN, enter Y if an automatic message accounting (AMA) record is required for each VPN call. Otherwise, enter N.</p> <p>An AMA record is not generated if an address complete message (ACM) of address complete, no charge is returned, or if the call terminates in the SSP on a line with the free number terminating (FNT) option.</p>
	CALLCLASS	PRESELEC, CALLTYPE, OVERRIDE, CSN, or TRUNK	<p>Preselection call processing. If the entry in subfield OSEL is PRESEL, datafill this refinement. Enter the preselection call class type that is associated with the call. For charge category routing, enter CALLTYPE.</p> <p>Note: Calltype CSN and TRUNK are available under the PRESEL option. These call classes are not needed for German Carrier Selection, and are not supported. The same applies to the Continue option of CONT. For the German market, only NOCONT is supported.</p>

ACHEAD (continued)**Field descriptions for conditional datafill (Sheet 8 of 15)**

Field	Subfield	Entry	Explanation and action
	CALLCTRL	CALLED, CALLING, LAST, or MUTUAL	<p>Call control. If the entry in subfield OSEL is CALLCTRL, datafill this refinement. Enter one of the following values to specify the party controlling the call:</p> <ul style="list-style-type: none"> • If the entry is CALLED and the called line goes on-hook first, the call is released immediately. If the calling line goes on-hook first and does not reanswer, the connection is not released until the called line goes on-hook. There are no time-outs, and the calling party is allowed to reanswer until the called line goes on-hook. Calls to lines with option ESG must have CALLCTRL(CALLED). Calls terminating on an ITOPS position must have CALLCTRL(CALLED). • If the entry is CALLING and the calling line goes on-hook first, the call is released immediately. If the called line goes on-hook first, the called party is allowed to reanswer within a datafilled reanswer time-out or until the calling line goes on-hook. If the time-out expires or if the calling line goes on-hook, the calling party releases the call and the called line is set to idle. • If the entry is LAST, the call is released when the later of the called party or the calling party goes on-hook. If either party goes on-hook, that party is allowed to reanswer within a datafilled reanswer time-out or until both parties go on-hook. • If the entry is MUTUAL and either line goes on-hook, the call is released immediately.
	CATRTE	CATRTE	Enter CATRTE to allow charge category routing in IBN translations.
	CDNNAME	alphanumeric string	Called number name. If the entry in subfield OSEL is SETCDN, enter data for this refinement to route the call using the called number name from table CDNCHAR.

ACHEAD (continued)**Field descriptions for conditional datafill (Sheet 9 of 15)**

Field	Subfield	Entry	Explanation and action
	CHG	SEND_ CHARGE or SEND_NO_ CHARGE	Charge. If the entry in subfield OSEL is TOC, enter SEND_CHARGE to set the answer message (BTUP ANM) type of answer (TOA) string sent from a node to SEND_CHARGE. Enter SEND_NO_CHARGE to set the answer message (BTUP ANM) type of answer (TOA) string sent from a node to SEND_NO_CHARGE.
	CICSIZE	1 to 4	CIC size. If the entry in subfield OSEL is EXTCIC, enter data for this refinement. This field indicates the number of digits in the CIC. This field operates on the B (called) number, so it is assumed that the switch signals the CIC as part of the B number. The MAP display indicates the range is 0 to 4. The system does not allow a 0 entry.
	CLDFMT	CURRENT or POSTXLA	Called format. If the entry in subfield OSEL is CAMA, enter either CURRENT or POSTXLA to produce the required ICAMA record format. If the entry is CURRENT, an ICAMA record is produced with the signaled DN (without translation). If the entry is POSTXLA, an ICAMA record is produced with a PSTN number resulting from translations.

ACHEAD (continued)**Field descriptions for conditional datafill (Sheet 10 of 15)**

Field	Subfield	Entry	Explanation and action
	CLASS	ATT, CNTL, COLL, DATT, EMRG, IAGRP, ICNTL, INTL, IOPRA, LCL, NATL, OPRA, RURAL, SPEC, UNKW, or URBAN	<p>Translation class. If the entry in subfield OSEL is CLASS, enter the translation class determined by the dialed digits. This can be used for screening or billing as described under CLASS in screening and charging options.</p> <p>The translation classes are defined as follows:</p> <ul style="list-style-type: none"> • ATT (attendant console) • CNTL (continental) • COLL (collect) • DATT (dial attendant) • EMRG (emergency) • IAGRP (interagent group) • ICNTL (intercontinental) • INTL (international) • IOPRA (international operator assisted) • LCL (local) • NATL (national) • OPRA (operator assisted) • RURAL (rural) • SPEC (special) • UNKW (unknown) • URBAN (urban)
	CONDIGS	numeric (0 to 29 digits)	Consumed digits. If the entry in subfield OSEL is CONSUME, datafill this refinement. Enter a number to explicitly define the number of digits consumed during call processing.
	CONTINUE	CONT, NOCONT	Continue. If the entry in subfield OSEL is PRESEL, enter data for this refinement. Enter CONT to continue with the current translations system. Enter NOCONT to stop translations.

ACHEAD (continued)**Field descriptions for conditional datafill (Sheet 11 of 15)**

Field	Subfield	Entry	Explanation and action
	CPMCALL	Y or N	Called party metering. If the entry in subfield OSEL is CPMCALL, enter Y (yes) if calls are billed against the called party for intraoffice calls. Enter N (no) for the default value of billing against the calling party for intraoffice calls.
	DDIDX	1 to 63 or DEFAULT	Destination discount index. If the entry in subfield OSEL is DDIDX, enter data for this refinement to apply the destination discount to the call.
	DEST	0 to 1023	Destination route list index. If the entry in subfield OSEL is DEST, enter the number in the route list, of the same translation system, that the call is routed to.
	IAA_INDEX	0 to 1024	Interadministration accounting index. If the entry in subfield OSEL is IAA, datafill this refinement. Enter the value that indexes the corresponding tuple in table IAACRRL.
	LNET	alphanumeric (1 to 16 characters)	Logical network. If the entry in subfield OSEL is LNET, enter the logical network name that the call is on. The logical network name must be previously datafilled in table LNETWORK. The entry in this field is used by the international metering system to determine a tariff for the call.
	MAX	0 to 30	Maximum digits. If the entry in subfield OSEL is MM, datafill this refinement. Enter the maximum number of digits expected. This value includes the digits used to index the current tuple and must also include the prefix digits specified in the current tuple.
	MIN	0 to 30	Minimum digits. If the entry in subfield OSEL is MM, datafill this refinement. Enter the minimum number of digits expected. This value includes the digits used to index the current tuple and must also include the prefix digits specified in the current tuple.

ACHEAD (continued)**Field descriptions for conditional datafill (Sheet 12 of 15)**

Field	Subfield	Entry	Explanation and action
	MZONE	0 to 63	Metering zone. If the entry in subfield OSEL is MZONE, enter the metering zone of the call, in the logical network as defined by selector LNET. The entry in this field is used by the international metering system to determine a tariff for the call.
	NETSRV_ NAME	IPHS, DPHS, MOBILE, DA, TELEGRAM, or NCC	<p>Network service name. If the entry in subfield OSEL is NETSRV, datafill this refinement. The entry in this field determines the parameters in an outgoing IAM message.</p> <p>Enter IPHS to indicate a call to an independent personal handyphone system subscriber.</p> <p>Enter DPHS to indicate a call to a dependent personal handyphone system subscriber.</p> <p>Enter MOBILE to indicate a call to a mobile subscriber.</p> <p>Enter DA to indicate a call to the directory assistance operator.</p> <p>Enter TELEGRAM to indicate a call to the Telegram office.</p> <p>Enter NCC to indicate a call routed to one of the following networks:</p> <ul style="list-style-type: none"> • New Common Carrier serving international toll traffic • New Common Carrier serving national toll traffic
	NICRF	NICRF	NIC routing function. This option allows transit calls prefixed with the NIC to access table PNINFO to route the call based on the NIC. Note that the NICRF and PNRF options are incompatible and cannot be datafilled on the same tuple.

ACHEAD (continued)**Field descriptions for conditional datafill (Sheet 13 of 15)**

Field	Subfield	Entry	Explanation and action
	NOA	INTL, LOCAL, NATL, or NET	<p>Nature of address. Enter the required called party nature of address.</p> <ul style="list-style-type: none"> • INTL (international) • LOCAL (local) • NATL (national) • NET (Intelligent Network Services)
	ONNET	Y or N	<p>Call on virtual private network. If the entry in subfield OSEL is VPN, enter Y if the call stays within the defined virtual private network. Otherwise, enter N.</p> <p>Overlapped outpulsing is supported only on off-network calls. Calls processed without subfield ONNET set to Y are off-network calls. Meridian Digital Centrex (MDC) calls are treated as off-network calls, and therefore overlapped outpulsing is supported for MDC calls.</p>
	PCCDR	0 to 9, B, C, D, E (1 to 3 digits)	<p>Pseudo country code digits. If the entry in subfield OSEL is PCC, enter the three-digit pseudo country code (PCC). If a two-digit PCC is required, it must be padded by a leading zero.</p> <p>The pseudo country code is used to record a particular pseudo country code. This can be extracted for use by system logic later, for example, two-stage outpulsing.</p>
	PFDIGS	0 to 24	<p>Number of prefix digits. If the entry in subfield OSEL is PF, datafill this refinement. Enter the number of prefix digits. If prefix digits are identified in a previous table, this number is added to the existing value. Prefix digits are not used to index any further translation tables and are not outpulsed, but they remain stored in call detail records (CDR).</p> <p>Note: If refinements PF and CONSUME are both datafilled for the same tuple, only the entry for the greater of the two values is processed; the other entry is ignored.</p>

ACHEAD (continued)**Field descriptions for conditional datafill (Sheet 14 of 15)**

Field	Subfield	Entry	Explanation and action
	PFXAMA	0 to 4 digits, or N	Called party number prefix in AMA. If NOA is set to NTL, datafill PFXAMA with 0011. If NOA is set to NATL, datafill PFXAMA with 0. If NOA is set to LOCAL or NET, datafill PFXAMA with N.
	PNRF	PNRFOPTS	Ported number recognitions function. Datafill the PNRFOPTS options vector and the INSNG subfields:
	INSNG	See subfields	
	INSNG_PREFIX IX	0 to 10	INSNG_PREFIX indicates the number of leading digits to be copied from an originator's DN and prefixed to the translating number.
	TRUNK_ACCESS_DIG	0 to 9, or N	TRUNK_ACCESS_DIG enables the specification of a trunk access digit to be prefixed to the translating number after the INSNG_PREFIX function has been completed.
	PORTED	PORTED or blank	Number portability indicator. This entry indicates that the service number for this call has been ported.
	PRIVL	Y or N	Privileged user. If the entry in subfield OSEL is PRIVL, enter Y (yes), if the user is a privileged user (for example, operator). Otherwise, enter N (no).
	SKIPDIGS	0 to 24	Skip digits. If the entry in subfield OSEL is EXTCIC, enter data for this refinement. This field indicates the number of digits to skip before removing the carrier digits from the digit stream. This field operates on the B (called) number, so it is assumed that the system signals the CIC as part of the B number.

ACHEAD (continued)**Field descriptions for conditional datafill (Sheet 15 of 15)**

Field	Subfield	Entry	Explanation and action
	SOURCE	PRESUB or DIALED	Carrier identification code source. If the entry in subfield OSEL is EXTCIC, enter data for this refinement. This field specifies the source of the CIC as follows: <ul style="list-style-type: none"> • PRESUB - presubscribed. Table TRKGRP contains the definition of the CIC. • DIALED - dialed. The subscriber enters the CIC when dialing a call.
	STOPRTMR	Y or N	Stop remote timer. Enter Y (yes) to disable the address complete message (ACM) timer of the remote switch. The default value is N (no).
	XLAID	FREE, GENERIC1, GENERIC2, or GENERIC3	AMA translation identifier. If the entry in subfield OSEL is AMAXLAID, enter the AMA translation identifier to be used against table AMAXLAID.

XLASEL = TRMT

If the entry in subfield XLASEL is TRMT, datafill the following refinements.

ACHEAD (continued)

Route to the specified treatment. A treatment is a known exception or failure condition. The action taken terminates translation, returning an indication that a treatment was encountered and decoded into a route.

Field descriptions for conditional datafill

Field	Subfield	Entry	Explanation and action
	OPT	see subfield	Options. This field is a vector consisting of up to ten options. Each option consists of subfield OSEL, and refinements that depend on the entry in subfield OSEL. For each option, specify the option selector (OSEL), followed by a space, and the refinements, each separated by a space. The entry is concluded by a \$ and datafill continues with field DFOP.
	OSEL	OFC	Option selector. Enter OFC, followed by a space, and datafill refinement OFC, if a treatment name is required.
	OFC	alphanumeric (1 to 4 characters)	Office treatment. Enter a treatment name that is contained in the office treatment subtable, TMTCNTL.TREAT.

XLASEL = all entries

Table AMAXLAID must be datafilled prior to selecting option AMAXLAID in field OSEL.

ACHEAD (continued)

For all entries in subfield XLASEL, datafill the following refinements.

Field descriptions for conditional datafill (Sheet 1 of 15)

Field	Subfield	Entry	Explanation and action
	DFOP	DFOP or NODFOP	<p>Default options. Enter DFOP and datafill subfield OSEL and its refinements.</p> <p>The default options apply only if a tuple with field XLASEL set to RTE or CONT is chosen in the CODE table.</p> <p>If the entry in field DFOP is equal to DFOP, this field is a vector that consists of a number of options. Each option, consisting of subfield OSEL and refinements dependent on the entry in subfield OSEL, is separated from the next by a space. The various refinements are described in subfield OSEL. For each option, specify the option selector, followed by a space, and the refinements, with each refinement separated from the next by a space. The entry is concluded by a \$ and datafill continues with field CON.</p> <p>Enter NODFOP if there are no default options and datafill field CON.</p> <p>In the case of the dialed digits resolving into an RTE or CONT selector, any options not datafilled against the digits can be defaulted to the value specified here. This facility, and option DFLT, are intended to minimize the amount of datafill required in any given CODE table, especially if most of the expected codes have the same attributes. If an option is applicable to most, but not all, tuples in the CODE table instance, the option can still be datafilled in the default options. Options datafilled in the CODE table tuples override the options in the HEAD table, so the different value can be datafilled into those few CODE tuples to which the default option does not apply.</p>

ACHEAD (continued)**Field descriptions for conditional datafill (Sheet 2 of 15)**

Field	Subfield	Entry	Explanation and action
	OSEL	ACF, AMAXLAID, CALLCTRL, CAMA, CDN, CDNRTE, CLASS, CLIOVRD, CONSUME, CPCRTE, CPMCALL, DDIDX, DEST, EXTCIC, IAA, LNET, MM, MZONE, NETSRV, OSS, PCC, PF, PNRF, PRESEL, PRIVL, QFT, SETCDN, TELETAXE, TOC, VPN, or XLT	<p>Option selector. The following options can be selected:</p> <p>Enter ACF, followed by a space, and datafill refinement ACF if the area code fence is defined.</p> <p>Enter AMAXLAID, followed by a space, and datafill refinement XLAID to specify an automatic message accounting (AMA) identity from within table AMAXLAID.</p> <p>Enter CALLCTRL, followed by a space, and datafill refinement CALLCTRL. The entry in refinement CALLCTRL indicates who has control of the call: the calling party, the called party, or both.</p> <p>Enter CAMA, followed by a space, and datafill refinement CLDFMT. The entry in CLDFMT indicates whether the international automatic message accounting (ICAMA) record is generated with the the originally signaled directory number (DN) or the final public switched telephone network (PSTN) number.</p> <p>Enter CDN, followed by a space, and datafill refinement CDN to select the nature of address field. This field is used to identify the called party of the initial address message (IAM). It is used for Australian ISDN user part (AISUP) call translations.</p> <p>Enter CDNRTE to route a call using the called number name (CDNNAME) from table CDNCHAR. If the CDNNAME is present on the incoming call or is set by the SETCDN option, translation proceeds to table CDNUXLA. The CDNRTE option does not have refinements.</p> <p>Enter CLASS, followed by a space, and datafill refinement CLASS if the class of the dialed digits can be determined.</p> <p>Enter CLIOVRD, followed by a space, and enter data for refinement CLIOVRD. This subfield indicates calling line identity override.</p>

ACHEAD (continued)**Field descriptions for conditional datafill (Sheet 3 of 15)**

Field	Subfield	Entry	Explanation and action
			<p>Enter CONSUME, followed by a space, and datafill refinement CONDIGS to specify the number of digits that are consumed during translation.</p>
			<p>Enter CPCRTE to route the call using the calling party category (CPCNAME) from table CPCCHAR. If the CPCNAME is present on the incoming call, translation proceeds to table CPCUXLA. The CPCRTE option does not have refinements.</p>
			<p>Enter CPMCALL, followed by a space, and datafill refinement CPMCALL to specify call billing against the called party instead of the calling party for intraoffice calls.</p>
			<p>Enter DDIDX, followed by a space, and enter data for refinement DDIDX. This option indicates a destination discount applies to the call.</p>
			<p>Enter DEST, followed by a space, and datafill refinement DEST if the destination is known.</p>
			<p>Enter EXTCIC, followed by a space, and enter data for refinements CICSIZE, SKIPDIGS, and SOURCE. The EXTCIC option indicates the external carrier identification code. This option is supported for TOPS calls.</p>
			<p>Enter IAA, followed by a space, and enter data for refinement IAA_INDEX. The IAA option generates or modifies IAA message parameters based on datafill in table IAACtrl.</p>

ACHEAD (continued)

Field descriptions for conditional datafill (Sheet 4 of 15)

Field	Subfield	Entry	Explanation and action
			<p>Enter LNET, followed by a space, and enter data for refinement LNET. Enter data for this option if the system requires a logical network for metering.</p>
			<p>Enter MM, followed by a space, and datafill refinements MIN and MAX if the minimum and maximum dialed digits are known.</p>
			<p>Enter MZONE, followed by a space, and datafill refinement MZONE if metering is to be done on the call.</p>
			<p>Enter NETSRV and datafill refinement NETSRV_NAME to indicate a Japan network service.</p>
			<p>Enter OSS to indicate operator signaling services. This subfield does not have refinements.</p>
			<p>Enter PCC, followed by a space, and datafill refinement PCCDR if a pseudo country code is required.</p>
			<p>Enter PF, followed by a space, and datafill refinement PFDIGS if there are prefix digits in the digit stream.</p>
			<p>Enter PNRF to invoke the ported number recognition function. LNP applications in Germany use the PRNF. The PNRF option does not have refinements.</p>
			<p>Enter PRESEL, followed by a space, and datafill refinement PRESEL to provide the necessary information used to index into the PCIXLA table.</p>
			<p>Enter PRIVL, followed by a space, and datafill refinement PRIVL if the user is a privileged user (for example, operators).</p>

ACHEAD (continued)

Field descriptions for conditional datafill (Sheet 5 of 15)

Field	Subfield	Entry	Explanation and action
			<p>Enter QFT followed by ON or OFF to indicate if an outgoing route is capable of QSIG feature transparency.</p> <p>Note: Operating company personnel must not add the QFT ON option to a route unless the far-end node is QFT-capable.</p> <p>Enter SETCDN, followed by a space, and enter data for refinement CDNNAME. The SETCDN option assigns the called number name (CDNNAME) from table CDNCHAR to the call.</p> <p>Enter TELETAXE. This option does not have refinements.</p> <p>Enter TOC, followed by a space, and datafill refinement CHG for the type of charge if the type of charge messaging is selected.</p> <p>Enter VPN, followed by a space, and datafill refinements ONNET and BILLABLE if the call routes through a service switching point (SSP) and the Australian VPN-SSP feature is present in the switch.</p> <p>Enter XLT, followed by a space, and datafill refinement XLASYS if the call is to proceed to another translation system.</p>
	ACF	0 to 29	<p>Area code fence. If the entry in subfield OSEL is ACF, datafill this refinement. Enter the number of digits between the beginning of the digits to currently index the table, and the end of the area code.</p>
	BILLABLE	Y or N	<p>Virtual private network billable call. If the entry in subfield OSEL is VPN, datafill this refinement. Enter Y if an AMA record is required for each VPN call. Otherwise, enter N. An AMA record is not generated if an address complete message (ACM) of address complete, no charge is returned, or if the call terminates in the SSP on a line with the free number terminating (FNT) option.</p>

ACHEAD (continued)

Field descriptions for conditional datafill (Sheet 6 of 15)

Field	Subfield	Entry	Explanation and action
	CALLCLASS	PRESELECT OVERRIDE, CALLTYPE, CSN, or TRUNK	<p>Preselection call processing. If the entry in subfield OSEL is PRESEL, datafill this refinement. Enter the preselection call class type that is associated with the call. For charge category routing, enter CALLTYPE.</p> <p>Note: Calltype CSN and TRUNK are available under the PRESEL option. These call classes are not needed for German Carrier Selection, and are not supported. The same applies to the Continue option of CONT. For the German market, only NOCONT is supported.</p>

ACHEAD (continued)**Field descriptions for conditional datafill (Sheet 7 of 15)**

Field	Subfield	Entry	Explanation and action
	CALLCTRL	CALLED, CALLING, or MUTUAL	<p>Call control. If the entry in subfield OSEL is CALLCTRL, enter one of the following three values to specify the party that has control of the call:</p> <ul style="list-style-type: none"> If the entry is CALLED and the called line goes on-hook first, the call is released immediately. If the calling line goes on-hook first and does not reanswer, the connection is not released until the called line goes on-hook. There are no time-outs, and the calling party is allowed to reanswer until the called line goes on-hook. <p>Calls to lines with option ESG must have CALLCTRL(CALLED).</p> <p>Calls terminating on an ITOPS position must have CALLCTRL(CALLED).</p> <ul style="list-style-type: none"> If the entry is CALLING and the calling line goes on-hook first, the call is released immediately. If the called line goes on-hook first, the called party is allowed to reanswer within a datafilled reanswer time-out or until the calling line goes on-hook. If the time-out expires or if the calling line goes on-hook, the calling party releases the call and the called line is set to idle. If the entry is MUTUAL and either line goes on-hook, the call is released immediately.
	CDNNAME	alphanumeric string	Called number name. If the entry in subfield OSEL is SETCDN, enter data for refinement CDNNAME.

ACHEAD (continued)

Field descriptions for conditional datafill (Sheet 8 of 15)

Field	Subfield	Entry	Explanation and action
	CHG	SEND_ CHARGE or SEND_NO_ CHARGE	Charge. If the entry in subfield OSEL is TOC, datafill this refinement. Enter SEND_CHARGE to set the answer message (BTUP ANM) type of answer (TOA) string sent out from a node to SEND_CHARGE. Enter SEND_NO_CHARGE to set the answer message (BTUP ANM) type of answer (TOA) string sent out from a node to SEND_NO_CHARGE.
	CICSIZE	1 to 4	CIC size. If the entry in subfield OSEL is EXTCIC, enter data for this refinement. This field indicates the number of digits in the CIC. This field operates on the B (called) number, so it is assumed that the system signals the CIC as part of the B number. The MAP display indicates the range is 0 to 4. The system does not allow an entry of 0.
	CLDFMT	CURRENT or POSTXLA	Called format. If the entry in subfield OSEL is CAMA, enter either CURRENT or POSTXLA to produce the required ICAMA record format. If the entry is CURRENT, an ICAMA record is produced with the signaled DN (without translation). If the entry is POSTXLA, an ICAMA record is produced with public switched telephone network (PSTN) number resulting from translations.

ACHEAD (continued)**Field descriptions for conditional datafill (Sheet 9 of 15)**

Field	Subfield	Entry	Explanation and action
	CLASS	ATT, CNTL, COLL, DATT, EMRG, IAGRP, ICNTL, INTL, IOPRA, LCL, NATL, OPRA, RURAL, SPEC, or UNKW	<p>Translation class. If the entry in subfield OSEL is CLASS, datafill this refinement. Enter the translation class determined by the dialed digits. This can be used for screening or billing purposes as described under CLASS in screening and charging options.</p> <ul style="list-style-type: none"> • ATT (attendant console) • CNTL (continental) • COLL (collect) • DATT (dial attendant) • EMRG (emergency) • IAGRP (interagent group) • ICNTL (intercontinental) • INTL (international) • LCL (local) • IOPRA (international operator assisted) • NATL (national) • OPRA (operator assisted) • RURAL (rural) • SPEC (special) • UNKW (unknown)
	CLIOVRD	CNA, CNB	<p>Calling line identity override. If the entry in subfield OSEL is CLIOVRD, enter data for refinement CLIOVRD. Enter CNA to allow the calling number for each call. Enter CNB to block the calling number for each call.</p>
	CONDIGS	numeric (0 to 29 digits)	<p>Consumed digits. If the entry in subfield OSEL is CONSUME, datafill this refinement. Enter a number to explicitly define the number of digits consumed during call processing.</p>

ACHEAD (continued)**Field descriptions for conditional datafill (Sheet 10 of 15)**

Field	Subfield	Entry	Explanation and action
	CONTINUE	CON or NOCON	<p>Consume digits. The default options apply if a tuple with field XLASEL set to CONT or DMOD is chosen in the CODE tables.</p> <p>The default case is not to consume digits (that is, the next table is indexed using the same digits as the current table, except for ignoring prefix digits). However, under certain conditions, the next table is indexed starting with the digits following the index to the current table (in other words, translations absorb or consume the current index digits). An example of this is when an area code is found in table FACODE. Table OFCCODE is indexed with the digits following the area code (the office code), so the digits used to index table FACODE are consumed. This does not mean that the digits are deleted from the digit register. They remain there and are outpulsed unless explicitly deleted in the CODE or RTE tables. The CON option only means that the digits are not used to index the next table.</p> <p>Enter CON and translation consumes the current index digits, if the next table is indexed starting with the digits following the index to the current table.</p> <p>Enter NOCON if digits are not to be consumed (the next table is indexed using the same digits as the current table, except the prefix digits).</p>
	CPMCALL	Y or N	<p>Called party metering. If the entry in subfield OSEL is CPMCALL, datafill this refinement. Enter Y (yes) if calls are billed against the called party for intraoffice calls. Enter N (no) for the default value of billing against the calling party for intraoffice calls.</p>
	DDIDX	1 to 63 or DEFAULT	<p>Destination discount index. If the entry in subfield OSEL is DDIDX, enter data for this refinement. Enter the destination discount index number.</p>

ACHEAD (continued)**Field descriptions for conditional datafill (Sheet 11 of 15)**

Field	Subfield	Entry	Explanation and action
	DEST	0 to 1023	Destination route list index. If the entry in subfield OSEL is DEST, datafill this refinement. Enter the number in the route list of the translation system that the call is routed to.
	IAA_INDEX	0 to 1024	Interadmission accounting index. If the entry in subfield OSEL is IAA, enter data for this refinement. Enter the value that indexes the corresponding tuple in table IAACTRL.
	LNET	alphanumeric (1 to 8 characters)	Logical network. If the entry in subfield OSEL is LNET, enter data for this refinement. This refinement specifies the name of the logical network that carries the call. Table LNETWORK must already have the logical network. The international metering system uses the entry in this field to determine the tariff for the call.
	MAXIDX	C, F, 9, or STD	<p>Maximum index. Enter C if the translation tables are to be indexed by dialed digits hexadecimal B (*) and hexadecimal C (#) in addition to digits in the range 0 to 9.</p> <p>Enter F if the translation tables are to be indexed by dialed digits in the range 0 to 9, and hex digits B, C, D, E, and F.</p> <p>Enter STD or 9 if the translation tables are to be indexed by dialed digits in the range 0 to 9. The default entry is 9.</p>
	MAX	0 to 30	Maximum digits. If the entry in subfield OSEL is MM, datafill this refinement. Enter the maximum number of digits expected. This value includes the digits used to index the current tuple and must also include the prefix digits specified in the current tuple.
	MIN	0 to 30	Minimum digits. If the entry in subfield OSEL is MM, datafill this refinement. Enter the minimum number of digits expected. This value includes the digits used to index the current tuple and must also include the prefix digits specified in the current tuple.

ACHEAD (continued)**Field descriptions for conditional datafill (Sheet 12 of 15)**

Field	Subfield	Entry	Explanation and action
	MZONE	0 to 63	Metering zone. If the entry in subfield OSEL is MZONE, datafill this refinement. Enter the metering zone of the call, in the logical network as defined by selector LNET. The entry in this field is used by the international metering system to determine a tariff for the call.
	NETSRV_ vvbNAME	IPHS, DPHS, MOBILE, DA, TELEGRAM, or NCC	<p>Network service name. If the entry in subfield OSEL is NETSRV, datafill this refinement. The entry in this field determines the parameters in an outgoing IAM message.</p> <p>Enter IPHS to indicate a call to an independent personal handyphone system subscriber.</p> <p>Enter DPHS to indicate a call to a dependent personal handyphone system subscriber.</p> <p>Enter MOBILE to indicate a call to a mobile subscriber.</p> <p>Enter DA to indicate a call to the directory assistance operator.</p> <p>Enter TELEGRAM to indicate a call to the Telegram office.</p> <p>Enter NCC to indicate a call routed to one of the following networks:</p> <ul style="list-style-type: none"> • New Common Carrier serving international toll traffic • New Common Carrier serving national toll traffic
	NOA	INTL, LOCAL, NATL, or NET	<p>Called nature of address parameter. If the entry in subfield OSEL is CDN, datafill this refinement. Enter the required called party nature of address.</p> <p>If the called party is an international number, enter INTL. If the called party is a local number, enter LOCAL. If the called party is a national number, enter NATL. If the called party subscribes to Intelligent Network Services, enter NET.</p>

ACHEAD (continued)

Field descriptions for conditional datafill (Sheet 13 of 15)

Field	Subfield	Entry	Explanation and action
	ONNET	Y or N	<p>Call on virtual private network. If the entry in subfield OSEL is VPN, datafill this refinement. Enter Y (yes) if the call stays within the defined virtual private network. Otherwise, enter N (no).</p> <p>Overlapped outpulsing is supported only on off-network calls. Calls processed without the ONNET subfield set to Y are off-network calls. Meridian Digital Centrex (MDC) calls are treated as off-network calls, and therefore overlapped outpulsing is supported for MDC calls.</p>
	PCCDR	0 to 9, B, C, D, E (1 to 3 digits)	<p>Pseudo country code digits. If the entry in subfield OSEL is PCC, datafill this refinement. Enter the three-digit pseudo country code (PCC). If a two-digit PCC is required, it must be padded by a leading zero.</p> <p>The pseudo country code is used to record a particular pseudo country code. This can be extracted for use by system logic later, for example, two-stage outpulsing.</p>
	PFDIGS	0 to 24	<p>Number of prefix digits. If the entry in subfield OSEL is PF, datafill this refinement. Enter the number of prefix digits. If prefix digits are identified in a previous table, this number is added to the existing value. Prefix digits are not used to index any further translation tables and are not outpulsed, but they remain stored in call detail records (CDR).</p> <p>Note: If refinements PF and CONSUME are both datafilled for the same tuple, only the entry for the greater of the two values is processed; the other entry is ignored.</p>
	PFXAMA	0 to 4 digits or N	<p>Called party number prefix in AMA. If NOA is set to NTL, enter 0011 in PFXAMA.</p> <p>If NOA is set to NATL, enter 0 in PFXAMA.</p> <p>If NOA is set to LOCAL or NET, enter N in PFXAMA.</p>

ACHEAD (continued)**Field descriptions for conditional datafill (Sheet 14 of 15)**

Field	Subfield	Entry	Explanation and action
	PRIVL	Y or N	Privileged user. If the entry in subfield OSEL is PRIVL, datafill this refinement. Enter Y (yes), if the user is a privileged user (for example, operator). Otherwise, enter N (no).
	SKIPDIGS	0 to 24	Skip digits. If the entry in subfield OSEL is EXTCIC, enter data for this refinement. This field indicates the number of digits to skip before removing the carrier digits from the digit stream. This field operates on the B (called) number, so it is assumed that the system signals the CIC as part of the B number.
	SOURCE	PRESUB or DIALED	Carrier identification code source. If the entry in subfield OSEL is EXTCIC, enter data for this refinement. This field specifies the source of the CIC as follows: <ul style="list-style-type: none"> • PRESUB - presubscribed. Table TRKGRP defines the CIC. • DIALED - dialed. The subscriber enters the CIC when dialing a call.
	STOPRTMR	Y or N	Stop remote timer. Enter Y (yes) to disable the address complete message (ACM) timer of the remote switch. The default value is N (no).
	XLAID	FREE, GENERIC1, GENERIC2, or GENERIC3	AMA translation identifier. If the entry in subfield OSEL is AMAXLAID, datafill this refinement. Enter the AMA translation identifier to be used against table AMAXLAID.

ACHEAD (continued)**Field descriptions for conditional datafill (Sheet 15 of 15)**

Field	Subfield	Entry	Explanation and action
	XLASYS	AC, AM, CT, DN, FA, FT, NSC, OFC, PX	<p>Translation system. If subfield OSEL is set to XLT, datafill this refinement. Enter the next translation system to use, followed by a space, then datafill refinement XLANAME.</p> <ul style="list-style-type: none"> • AC (access) • AM (ambiguous) • CT (country) • DN (directory number) • FA (foreign area) • FT (utility) • NSC (number service code) • OFC (office) • PX (prefix) <p>Note: NIL is not a valid entry. NIL is used only to satisfy internal software functionality.</p>
	XLANAME	alphanumeric (1 to 8 characters)	<p>Translation name. If the entry in subfield OSEL is XLT, datafill this refinement. Enter the translation name of the table instance within the XLASYS that the call is routed to.</p>

Datafill example

The following example shows sample datafill for table ACHEAD.

Example 1: digits on incoming trunks

The first example shows datafill for a universal translator that is called from incoming trunk groups that have datafill in table TRKGRP, with field XLASEL set to UNIV, field XLASYS set to PX, and field XLANAME set to ICTOLL.

The digits received on the incoming trunks are shown in the following table.

Digits on incoming trunks (Sheet 1 of 2)

Digits received	Explanation
0	Digits starting with 0 are invalid and are blocked
1007	Test call routed to test line TERMARTER

ACHEAD (continued)

Digits on incoming trunks (Sheet 2 of 2)

Digits received	Explanation
811 + 4 digits, 585 + 4 digits, 586 + 4 digits	Local calls within the area of this switching office with direct trunking
9 + 8 digits	National call, except digits starting with 90 or 91 that are invalid and are blocked
99 + 8 to 12 digits	International call

International calls route to the gateway office on outgoing trunk group with common language location identifier (CLLI) OGTOGATE.

National calls route to a toll office on an outgoing trunk group with CLLI OGTOTOLL.

Local calls route to the switching offices by outgoing trunk groups, OGTO811 and OGTO5856.

The first table to access is the prefix code table with instance ICTOLL.

For digits received on the incoming trunk, translation proceeds as shown in the following table.

Translation of digits on incoming trunks (Sheet 1 of 3)

Digits received	Explanation
0+	INVALID CALLSIn prefix code table, field XLANAME set to ICTOLL, this digit is not found, so the call uses the tuple, in table PXHEAD, DFLT CONT XLT OFC OFC18 to continue translation in table OFCCODE. The digits are not consumed, and the digit 0 (zero) is also not found in table OFCCODE, so it uses table OFCHEAD tuple SDFLT, the standard default that routes the call to vacant code.
1007	TEST LINE CALLIn table PXCOD, field XLANAME set to ICTOLL, RTE indicates that translation is to be terminated. MM 4 4 indicates that four digits in total are expected. DEST 5 indicates that table PXRTE with CNTOLL 5 gives the route list to use. The route list contains only one member: TERMARTER, the ARTER facility used for network testing in Turkey.

ACHEAD (continued)**Translation of digits on incoming trunks (Sheet 2 of 3)**

Digits received	Explanation
1+	<p>CALL WITHIN SAME AREA Because this office is in area 1, digit 1 must not be dialed in front of the office code. With the exception of 1007, digit 1 is not found in table PXCODE, field XLANAME set to ICTOLL, and the default routing in table PXHEAD DFLT CONT XLT OFC OFC18 indicates that further translation is required in table OFCCODE. In table OFCCODE, digit 1 is not found, so the call takes the default routing shown in table OFCHEAD, SDFLT, standard default, vacant code treatment.</p>
2+ and 8+	<p>LOCAL CALLS All calls starting with 2 to 8 are found in table PXCODE, field XLANAME set to TOLLCN, and DFLT CONT XLT OFC OFC18 indicates that further translation is required in table OFCCODE.</p> <p>In table OFCCODE, only digits 811, 585, and 586 are found, so any other digits take the default routing shown in table OFCHEAD, SDFLT, standard default, vacant code treatment. For calls starting with 811, DEST 10 indicates table OFCRTE with ICTOLL 10, gives the route list to use. The route list contains one member, OGTO811, two digits are deleted and none are prefixed. For calls starting with 585 or 586, DEST 11 indicates that table OFCRTE with ICTOLL 11, gives the route list to use. The route list contains one member, OGTO5856. No digits are deleted and none are prefixed.</p>
90+ and 91+	<p>INVALID DIGITS In prefix code table, field XLANAME set to ICTOLL, TRMT OFC VACT indicates that calls starting with these digits are routed to vacant code in table TMTCNTL.TREAT.</p>

ACHEAD (continued)

Translation of digits on incoming trunks (Sheet 3 of 3)

Digits received	Explanation
92+ to 98+	<p>SUBSCRIBER DIALED NATIONAL CALLIn prefix code table, field XLANAME set to ICTOLL, PF 1 indicates the presence of one prefix digit. CONT...XLT FA ICTOLL indicates that further translation is required, using table FACODE instance ICTOLL. The digits 92 to 98 are not consumed, but because of the PF option, the next table is indexed by the digits following 9. In table FACODE, if the digits following the 9 are 2 to 8, the call is routed to DEST 10 in table FARTE that is a route list with one member, trunk group OGTOTOLL. These are long distance calls to other cities. To simplify matters, the digits 2 to 8 are shown in one tuple, but can be expanded to show each area code to eliminate the transmitting of invalid numbers to the toll center.</p>
99+	<p>SUBSCRIBER DIALED INTERNATIONAL PREFIXIn table PXCOD, field XLANAME set to ICTOLL, PF 2 indicates the presence of two prefix digits. CONT...XLT CT CC indicates that further translation is required, using table CTCODE instance CC. The digits 99 are not consumed, but because of the PF option, the next table is indexed by the digits following 99. MM 8 12 indicates that 8 to 12 digits are expected. In table CTCODE, where the digits following 99 are 1 to 9, the call is routed to DEST 12 in table CTRTE, which in turn sends the call on trunk group OGTOGATE to the DMS-300 gateway office. Whether the country code received by the DMS-300 gateway office is valid or not is determined in the gateway office. With additional datafill, it can be determined in this office by entering all the country codes in table CTCODE. If 0 (zero) is the next digit following 99, the call is routed to the standard default, VACANT CODE.</p>

Datafill examples for example 1 The various translation tables used in example 1 are shown in the following.

ACHEAD (continued)

MAP display example for table PXHEAD

XLANAME		DFLT
		DFOP
CON	MAXIDX	

ICTOLL		
DFLT	CONT XLT OFC OFC18	\$
		NODFOP
NOCON	9	

MAP display example for table PXCODE

XLANAME	FROMD	TOD	XLADATA

ICTOLL	1007	1007	
RTE (DEST 5)	(MM 4 4)	\$	
ICTOLL	2	8	
CONT (XLT OFC OFC18)	(MM 7 7)	\$	
ICTOLL	90	90	
TRMT (OFC VACT)	\$		
ICTOLL	91	91	
TRMT (OFC VACT)	\$		
ICTOLL	92	98	
CONT (PF 1) (XLT FA ICTOLL)	(MM 8 8)	\$	
ICTOLL	99	99	
CONT (PF 2) (XLT CT CC)	(MM 8 12)	\$	

MAP display example for table PXRTE

XLANAME	RTEREF		RTELIST

ICTOLL	5		
		(S	TERMARTER)\$

ACHEAD (continued)

MAP display example for table CTHEAD

XLANAME		DFLT
CON	MAXIDX	DFOP
<hr/>		
CC		SDFLT
NOCON	9	NODFOP

MAP display example for table CTCODE

XLANAME	FROMD	TOD	XLADATA
CC	1	9	
RTE (DEST 12) \$			

MAP display example for table CTRTE

XLANAME	RTEREF	RTELIST
CC	12	(S OGTOGATE) \$

ACHEAD (continued)

MAP display example for table FAHEAD

XLANAME			DFLT
			DFOP
CON	MAXIDX		
<hr/>			
ICTOLL			SDFLT
			NODFOP
CON	9		

MAP display example for table FACODE

XLANAME	FROMD	TOD	XLADATA
<hr/>			
ICTOLL	2	8	
RTE (DEST 10) \$			

MAP display example for table FARTE

XLANAME	RTEREF		RTELIST
<hr/>			
ICTOLL	10		
(S OGTOTOLL) \$			

ACHEAD (continued)

MAP display example for table OFCHEAD

XLANAME	CON	MAXIDX	DFLT DFOP
OFC18			SLDFLT NODFOP
CON	9		

MAP display example for table OFCCODE

XLANAME	FROMD	TOD	XLADATA
OFC18	811	811	
RTE (DEST 10) \$			
OFC18	585	586	
RTE (DEST 11) \$			

MAP display example for table OFCRTE

XLANAME	RTEREF	RTELIST
OFC18	10	(N OGTO811 NOMOD 2 N) \$
OFC18	11	(S OGTO5856) \$

Example 2: routing of repair service calls

The second example provides access to a repair service. Subscribers dial 02 to report problems on the lines. During the hours 8:30 a.m. to 5:30 p.m., the calls terminate on a line in the same office. At other times, calls are automatically routed to a tandem office with digits 02 outpulsed.

The international translation tables provide time-of-day routing, and can specify retranslation with a new number from the route list. This redefines certain routes to a new destination.

ACHEAD (continued)

This example shows the routing of repair service calls differently after business hours, using the conditional time-of-day selector (CND) and the retranslate selector (RT).

- A subscriber dials 02 over a line defined with XLASYS XLANAME as PX P613.
- Translations starts with table PXC CODE.
- The TO and FROM digits in table PXC CODE determine that a route can be found at destination 8 of table PXRTE.
- Passage through the route list encounters a conditional selector.
- CONDTYPE TOD causes the time-of-day system to be referenced.
- To calculate the time span, a time stamp is taken and identified as either time 1 (8:30 a.m. to 5:30 p.m. on weekdays) or time 0 (any other time during the week and all weekend), as defined through field TOD in table TIMEODAY.
- Time is compared with field TIMES of the conditional selector.
- If current time is 1, the condition is true. The translation system is instructed to carry on with the route list in table PXRTE at tuple P613 11.
- The route list indicates that retranslation must be done with a new number starting at table PXC CODE, index P613. Using the new number, the TO and FROM digits indicate that translations continue in table DNCODE (for directory numbers) at index D726.
- Searching table DNCODE with the remaining four digits, termination is found on a line. The call attempts to connect to that line.
- If the current time was 0 (false returned), translation continues on the rest of the current route list. This means the routes of tandem1 to tandem3 are tried.

Datafill examples for example 2 The following example is one method that datafill is used to implement the repair feature. The first four tables are a few of the tables unique to the time-of-day routing system that are suitable for this example. Table DAYOYEAR is available for specifying holidays (not shown in this example). The last three tables are some of the tables in the international system that can be used.

ACHEAD (continued)

MAP display example for table DAYTYPES

DAYTYPE
WEEKDAY
WEEKEND

MAP display example for table TODHEAD

TODNAME	TODTYPE	DAYTYPES
REPAIR	RTE 1	(WEEKDAY) (WEEKEND)\$

MAP display example for table DAYOWEEK

TODNAME	WEEKDAY	DAYTYPE
REPAIR	MON	WEEKDAY
REPAIR	TUE	WEEKDAY
REPAIR	WED	WEEKDAY
REPAIR	THU	WEEKDAY
REPAIR	FRI	WEEKDAY
REPAIR	SAT	WEEKEND
REPAIR	SUN	WEEKEND

ACHEAD (continued)**MAP display example for table TIMEODAY**

TODNAME	DAYTYPE	TIME		DATA
REPAIR	WEEKDAY	0 0	RTE	1
REPAIR	WEEKDAY	8 30	RTE	2
REPAIR	WEEKDAY	17 30	RTE	1
REPAIR	WEEKEND	0 0	RTE	1

MAP display example for table PXCOD

XLANAME	FROMD	TOD	XLADATA
P613	02	02	
RTE (MM 2 2) (DEST 8) \$			
P613	726	726	
CONT (XLT DN D726) \$			

MAP display example for table PXRTE

XLANAME	RTEREF		RTELIST
P613	8		
(CDN TOD REPAIR 1 ST 11) (S TANDEM1)			
(S TANDEM2) (S TANDEM3)\$			
P613	11		
(RT 7261234 PX P613)\$			

MAP display example for table DNCODE

XLANAME	DNNO	DNTDATA
D726	1234	LINE (LEN 00 1 04 06) \$

ACHEAD (continued)

Example 3: destination checking in tables FTHEAD and FTCODE

The third example shows tables FTHEAD and FTCODE used for datafilling restricted call diversion (features CDO, CDA, and CDS defined in table LENFEAT). Office parameter CDS_DN_CHECK in table OFCVAR specifies an instance of table FTCODE used to screen the CDS destinations. Destinations that are not admissible are datafilled into this table. An attempt to program a call diversion to a destination datafilled in table FTHEAD results in failure. In the case of subscriber programming, a NACK treatment is given.

Datafill examples for example 3 In the example, attempting to program call diversion to a DN and using a destination of 58123 fails. Also, special service calls starting with 11 cannot be diverted.

MAP display example for table FTHEAD

XLANAME			DFLT
			DFOP
CON	MAXIDX		
<hr/>			
CDSCHK			
DFLT	RTE	\$	
			NODFOP
NOCON	9		

MAP display example for table FTCODE

XLANAME	FROMD	TOD	XLADATA
<hr/>			
CDSCHK	11	11	
TRMT	\$		
CDSCHK	58	58	
TRMT	\$		
CDSCHK	2250	2250	
TRMT	\$		

Example 4: datafilling subscriber procedures in tables ACHEAD and ACCODE

The fourth example shows possible datafill required in tables ACHEAD and ACCODE to specify the call diversion service codes and dialing sequences.

ACHEAD (continued)

Datafill examples for example 4 Codes defined by the Conference of European Postal and Telecommunications (CEPT) administrations are used in this example: 21 for CDS, 23 for CDO, and 20 for CDA are used for this example.

MAP display example for table ACHEAD

XLANAME		DFLT
CON	MAXIDX	DFOP
<hr/>		
FTRXLA		SDFLT
NOCON	B	NODFOP

MAP display example for table ACCODE

XLANAME	FROMD	TOD	XLADATA
FTRXLA	B21	B21	
FEAT (FTR CDS)	(FUNC ACT)	(PF 3)	\$
FTRXLA	C21	C21	
FEAT (FTR CDS)	(FUNC DEACT)	(PF 3)	\$
FTRXLA	BC21	BC21	
FEAT (FTR CDS)	(FUNC INTER)	(PF 4)	\$
FTRXLA	B23	B23	
FEAT (FTR CDO)	(FUNC ACT)	(PF 3)	\$
FTRXLA	C23	C23	
FEAT (FTR CDO)	(FUNC DEACT)	(PF 3)	\$
FTRXLA	BC23	BC23	
FEAT (FTR CDO)	(FUNC INTER)	(PF 4)	\$
FTRXLA	B20	B20	
FEAT (FTR CDA)	(FUNC ACT)	(PF 3)	\$
FTRXLA	C20	C20	
FEAT (FTR CDA)	(FUNC DEACT)	(PF 3)	\$
FTRXLA	BC20	BC20	
FEAT (FTR CDA)	(FUNC INTER)	(PF 4)	\$

ACHEAD (continued)

Example 5: datafilling announcements in tables FTHEAD, FTCODE, and FTRTE

Office parameter CDIV_SDN_XLA specifies a translation system and instance for translation of the announcement choice. Table FTCODE is recommended for this datafill.

Datafill examples for example 5 An example of datafill for table FTHEAD, FTCODE, and FTRTE is shown below.

MAP display example for table FTHEAD

XLANAME		DFLT
		DFOP
CON	MAXIDX	
<hr/>		
CDXLA		SDFLT
		NODFOP
NOCON	9	

MAP display example for table FTCODE

XLANAME	FROMD	TOD	XLADATA
<hr/>			
CDXLA	12	12	
RTE (DEST 1) \$			
CDXLA	13	13	
RTE (DEST 2) \$			
CDXLA	13	13	
RTE (DEST 3) \$			

ACHEAD (continued)**MAP display example for table FTRTE**

XLANAME	RTEREF		RTELIST
CDXLA	1	(S	ANN12)\$
CDXLA	1	(S	ANN13)\$
CDXLA	1	(S	ANN14)\$

The valid announcement choices are datafilled as two-digit entries in table FTCCODE. The example shows entries for 12, 13, and 14. These codes translate to announcements within the office.

If an activation is attempted (either from the subscriber set or from the MAP), the announcement choice must be datafilled in the above table, before the activation is accepted.

Example 6: default tuples for feature WLN in table ACCODE

The sixth example shows the default tuples datafilled at load-build time for entry WLN (Warm Line) in table ACCODE.

Datafill example for example 6 The CEPT-recommended code for WLN is 53. The operating company can use another two-digit numeric code.

MAP display example for table PXC CODE

XLANAME	FROMD	TOD	XLADATA
ACCXLA	B53	B53	
FEAT (FTR WLN)	(FUNC ACT)	(PF 3)	\$
ACCXLA	C53	C53	
FEAT (FTR WLN)	(FUNC DEACT)	(PF 3)	\$
ACCXLA	BC53	BC53	
FEAT (FTR WLN)	(FUNC INTER)	(PF 4)	\$

ACHEAD (continued)

Example 7: international line features CCW and INDC

The seventh example shows datafill for the following international line features:

- CCW (Cancel Call Waiting)
- INDC (International Double Connect)

Refer to table FEATCHG for a brief description of international line features.

MAP display example for table ACCODE

XLANAME	FROMD	TOD	XLADATA
FTRXLA	B36	B36	
FEAT (FTR CCW)	(PF 3)	(FUNC ACT)	\$
FTRXLA	B35	B35	
FEAT (FTR INDC)	(PF 3)	(FUNC ACT)	\$
FTRXLA	C35	C35	
FEAT (FTR INDC)	(PF 3)	(FUNC DEACT)	\$
FTRXLA	BC35	BC35	
FEAT (FTR INDC)	(PF 4)	(FUNC INTER)	\$

Example 8: international line features CDB, CDF, and IDND

The eighth example shows datafill for the following international line features:

- CDB (Call Diversion on Busy)
- CDF (Call Diversion Fixed)
- IDND (International Do Not Disturb)

Refer to table FEATCHG for a brief description of international line features.

ACHEAD (continued)**MAP display example for table ACCCODE**

XLANAME	FROMD	TOD	XLADATA
ACCXLA	B60	B60	
FEAT (FTR CDB)	(FUNC ACT)	(PF 3)	\$
ACCXLA	C60	C60	
FEAT (FTR CDB)	(FUNC DEACT)	(PF 3)	\$
ACCXLA	BC60	BC60	
FEAT (FTR CDB)	(FUNC INTER)	(PF 4)	\$
ACCXLA	B27	B27	
FEAT (FTR CDF)	(FUNC ACT)	(PF 3)	\$
ACCXLA	C27	C27	
FEAT (FTR CDF)	(FUNC DEACT)	(PF 3)	\$
ACCXLA	BC27	BC27	
FEAT (FTR CDF)	(FUNC INTER)	(PF 4)	\$
ACCXLA	B26	B26	
FEAT (FTR IDND)	(FUNC ACT)	(PF 3)	\$
ACCXLA	C26	C26	
FEAT (FTR IDND)	(FUNC DEACT)	(PF 3)	\$
ACCXLA	BC26	BC26	
FEAT (FTR IDND)	(FUNC INTER)	(PF 4)	\$

Example 9: Faultsman's Digit Tests (FDT)

Feature FDT enables a field engineer to test a telephone from the subscriber's premises. It complements the existing support for direct maintenance (no operator intervention) provided by field engineer's ringback.

The test operates in two stages:

1. Digit reception test (DRT): The integrity of digit reception is tested by dialing all digits on a push-button telephone or 0 (zero) on a rotary dial telephone. On a digit-pulse (DP) set, this test ensures that the make and break mechanisms are working. For dual-tone multifrequency (DTMF) sets, the test verifies that each digit can break dial tone. Jamming of push-buttons is also detected by DRT.
2. Directory number check (DNC): The intended directory number (DN) is dialed and checked against the value datafilled for that line. This test verifies the datafill.

Once datafilled, this feature is accessible from all lines connected to the switch, on the host and remotes for DP and DTMF telephones.

ACHEAD (continued)

Translations must be datafilled to enable termination with the feature. This is achieved by using the FEAT selector in one of the universal code translation tables.

Datafill examples for example 9 Setting the access code to 111 gives the field engineer the best chance of testing whether the telephone is faulty. A 1 requires the fewest pulses on a DP set, while using the same digit decreases the likelihood of having to use a bad key on a push-button set.

MAP display example for table PXHEAD

XLANAME		DFLT
		DFOP
CON	MAXIDX	

LOCAL8		
DFLT TRMT (OFC VACT) \$		
		NODFOP
NOCON	9	

MAP display example for table ACCODE

XLANAME	FROMD	TOD	XLADATA

LOCAL8	111	111	
FEAT (FTR FDT) \$			

Example 9: Station ringer test (SRT)

The ninth example describes the two methods used to access the station ringer test (SRT). The SRT tests that the directory number (DN) is correct and the ringer at the customer site is in service. Operating company personnel can perform the SRT at the customer site. The operating company can change the access code by changing the datafill options.

Method one uses an access code and the last five digits of the DN. Method one does not work if two DNs in the same office have the same last five digits. If two DNs share the same last five digits, use method two. Method two uses a three-digit access code and a seven- or ten-digit DN. Both methods work if DNs do not share the same last five digits on the same switch.

ACHEAD (continued)

Method one For method one, dial a two-digit access code and the last five digits of the DN. For example, the DN to test is 613-621-1234. Method one can use access code 57. The operating company personnel dial 571-1234 to activate the SRT on the DN.

Method two For method two, dial a three-digit access code and the seven digit DN. Or dial the three-digit access code, the three-digit numbering plan area (NPA), and the seven-digit DN. The three-digit NPA and the seven-digit DN make a ten-digit DN.

Use the ten-digit DN with the access code if a switch supports two DNs that are the same except for the NPA. If this condition occurs, the SRTs compare the number dialed against the station dialing, including the NPA.

Operating companies use different datafill options to accept one of the following dialing options:

- access code plus seven- or ten-digit DN
- access code plus seven-digit DN only
- access code plus ten-digit DN only

If the operating company selects the first option and the subscriber dials seven digits, a pause of several seconds occurs. After the pause, the system processes the call. The pause occurs because the line module (LM) waits to make sure that the subscriber does not dial additional digits.

For example, the DN to test is 613-621-1234. Method two uses code 999. The operating company personnel dials either 999-621-1234 or 999-613-621-1234 to activate the SRT.

If the switch supports another DN, 819-621-1234, the operating company personnel must dial 999-613-621-1234 to activate the SRT. If the operating company personnel use the seven-digit DN with the three-digit access code, both 613-621-1234 and 819-621-1234 DNs will ring.

Example 10: Wake-up Call (WUC)

The tenth example shows datafill in table ACCODE for the Wake-up Call feature (WUC).

ACHEAD (continued)

MAP display example for table ACCODE

XLANAME	FROMD	TOD	XLADATA
FTRXLA	B55	B55	
FEAT (FTR WUC)	(PF 3)	(FUNC ACT)	\$
FTRXLA	C55	C55	
FEAT (FTR WUC)	(PF 3)	(FUNC DEACT)	\$
FTRXLA	BC55	BC55	
FEAT (FTR WUC)	(PF 4)	(FUNC INTER)	\$

Example 11: International Ring Again (RAG)

The eleventh examples shows datafill in table ACCODE for the International Ring Again (RAG) feature.

MAP display example for table ACCODE

XLANAME	FROMD	TOD	XLADATA
FTRXLA	B37	B37	
FEAT (FTR RAG)	(FUNC ACT)	(PF 3)	\$
FTRXLA	C37	C37	
FEAT (FTR RAG)	(FUNC DEACT)	(PF 3)	\$
FTRXLA	BC37	BC37	
FEAT (FTR RAG)	(FUNC INTER)	(PF 4)	\$

Example 12: Silent Switchman (SSM)

The twelfth example shows datafill in table ACCODE for the Silent Switchman (SSM) feature.

MAP display example for table ACCODE

XLANAME	FROMD	TOD	XLADATA
FTRXLA	117	117	
FEAT (FTR SSM)			\$

ACHEAD (continued)

Table history**MMP14**

Added option DFT to selectors CONT and RTE.

MMP13

Added options PORTED, NICRF and, suboption INSNNG (to PNRF) to selectors CONT and RTE.

Added CATRTE option within OSEL under CONT, DMOD, and RTE selectors.

Added CALLTYPE option under PRESEL.

MMP12

Added option NOANSTIM to selectors CONT and RTE.

EUR010

Added option CPRTE to selectors CONT, DMOD, and RTE.

APC010

Added field TLC_CHARGE to option TLC in the FEATINFO selector.

APC009.1

Added station ringer test (SRT) information.

APC009

Added option NETSRV to selectors CONT and RTE.

Added option JES to selector FEATINFO.

EUR009

Added option BLKOVLP to selector RTE.

EUR008

Added the CDNRTE, SETCDN, VPNREPL, and VPNXLT options within the DMOD selector.

Added the CDNRTE, QFT ON, QFT OFF, SETCDN, and VPNPAN options within the CONT and RTE selectors.

GL04

Added field DFLT.

ACHEAD (continued)

Added the following options to selectors CONT and RTE:

- CHGIND
- FLEXCHG
- ISUPPREF

Note: The FLEXCHG and ISUPPREF indicators are obsolete, and have been removed from the tables.

APC008.1

The following updates were introduced in APC008.1 to table ACHEAD:

- Field CHKCCR was added to all subscriber types (SUBSCTYP) that are part of the SUBSCRN option of selector FEATINFO VALIDATE.
- Field EARLYCPG was added to selector FEATINFO.
- Option IAA was added to the CONT and RTE selectors.

EUR006

Added PRESEL option to the CONT and RTE selectors.

GL03

The following updates were introduced in GL03:

- Added ACF in CONT and RTE selectors.
- Added CAMA in CONT, DNRTE, and RTE selectors.
- Added HRC selector and PIP option within the RTE selector.
- Added URBAN to selector CLASS.

TL06

Added route selector SX.

APC006

PERSONAL subscriber type added to SUBSCRN option of FEATINFO VALIDATE.

NA005

Increased the number for universal support to 30 digits, affecting the following options, subfields, or selectors:

- ACF
- AFTER
- CONSUME

ACHEAD (end)

- DEL
- DMOD
- DNRTE
- INSRT
- MAX
- MIN
- PF
- REPL

Added option SF and its refinement SFDIGS to selector DNRTE.

Added note about potential conflict with refinements CONSUME and PFDIGS.

Corrected the prefix digits (PF) field description.

APC04

Subfield CDN of selectors CONT and RTE modified to incorporate subfields NOA, STOPRTMR, and PFXAMA.

BCS35

The following items were added:

- options CGNDM and CONSUME to subfield OSEL
- option BCSCRN to field VALDATOP
- general note on restrictions on use of value VALIDATE
- refinement CPMCALL to XLASEL selectors CONT and RTE

ACSCRN2**Table name**

Account Code Screening (ACSCRN2) table

Functional description

Table ACSCRN2 stores the account code database index and the list of valid account codes associated with each index. It uses a multi-part key consisting of the account code screening database index and an account code digit sequence.

The digit sequence associated with any index is of a fixed length from 2 to 12 digits. The initial datafill of an index/account code combination determines the length of account code digit sequences for all subsequent additions associated with that index. To change the length of account codes associated with an index, all account codes currently associated with that index are deleted, then an entry is made with an account code digit sequence of the new length.

To manipulate a tuple, supply an index and an account code digit sequence on the same command line. In the example POS 14 251097, 14 is the account code screening database index, and 251097 is the desired account code digit sequence.

Field descriptions

The following table describes field names, subfield names, and valid data ranges for table ACSCRN2.

Field	Subfield or refinement	Entry	Explanation and action
DBIDX		see subfields	DATABASE INDEX. Datafill the two-part key consisting of: KEY 1 and KEY 2.
	KEY 1	0 to 4294967295	ACCOUNT CODE INDEX. This value is not unique within the subfield ASCRN2. Use a value of 0 to turn off account code validation.
	KEY 2	2 to 12 digits (0 to 9)	ACCOUNT CODE. Enter the account code screening index filed in table AUTHCODU, ANISCUSP, or AUTHCDUX against the subscriber's authcode.

ACSCRN2 (end)

Datfill example

The following example shows data fill for table ACSCRN2.

	DBIDX
0	10000
1	10
2	10000
3	100
4	12345678889012

ACRTE

Table name

Access Code Route Table

Overview

The following is a list of the universal translations routing tables:

- ACRTE
- CTRTE
- FARTE
- FTRTE
- NSCRTE
- OFCRTE
- PXRTE

Use table ACRTE to datafill all the universal translations routing tables listed above. Exceptions relating to specific tables and datafill are noted where applicable.

For related information, refer to table ACHEAD.

Functional description

The route tables specify the route or routes to be followed after call translation.

Each route table contains the following fields:

- XLANAME — valid name from the corresponding HEAD table
- RTEREF — route reference index (1 to 1023)
- RTELIST — route list composed of a list of up to eight routes; each route has a selector, subfield RTESEL, and associated subfields

ACRTE (continued)

The following table indicates the refinements that can be datafilled in subfield RTESEL:

Route selector refinements (Sheet 1 of 3)

Entry in subfield RTESEL	Refinement	Explanation
CND	CONDITION	Specifies NRR or TOD plus refinements as CNDSEL. Note: The CDN NRR option is not supported in GSM offices.
	CONDRTE	One of ST, SK, or T plus refinements
DCRT	DCR_NETWORK	Network to which DCR destination node belongs to. This is one of the networks datafilled in table DCRNETID.
	DESTNAME	Valid destination node name from table DESTKEY
	OSID	Index into table DESTNODE, field OSID contains outpulsing scheme
N	CLLI	Common language name of a trunk group
	MODCHG	Modifies standard charging characteristics.
	DELETE	Number of digits to delete (0 to 8)
	PFXDIGS	Digits to prefix (up to 11 digits)
NODE	DCR_NETWORK	Network to which DCR destination node belongs. This is one of the networks datafilled in table DCRNETID.
	DESTNAME	Valid destination node name from table DESTKEY
	OSID	Index into table DESTNODE, field OSID contains outpulsing scheme.
NOT	CONDITION	Specifies NRR as CNDSEL.
	CONDRTE	One of ST, SK, or T plus refinements
RT	RTDIGITS	The digits to be retranslated.

ACRTE (continued)**Route selector refinements (Sheet 2 of 3)**

Entry in subfield RTESEL	Refinement	Explanation
S SG	XLASYS	One of AC, AM, CT, FA, FT, NSC, OFC, or PX
	XLANAME	Valid name from head table of XLASYS
	CLLI	Common language name of a trunk group
		Routes to a trunk group selected from those in the specified tuple in table SUPERTKG.
	ALGORITHM	Call distribution method, either cyclical (CYC) or random (RND)
	ATTEMPTS	The maximum number of trunk groups to be tested for a free trunk member.
SO	SUPERTKG_NAME	The name of the super-group previously datafilled in table SUPERTKG
	OPTIONS	An optional digit manipulation index (DMI) to table DIGMAN which allows the called number characteristics to be manipulated. Also an option of CALLTYPE, or type of call, is presented.
		Longhaul or SETCDN option from table PXRTE for ETSI ISUP trunks
		Note: The entry SO in subfield RTESEL is not valid for any universal translation routing tables.
	CLLI	Common language name of a trunk group
	DELETE	Number of digits to delete (0 to 18).
SX	AFTER	Number of leading digits after which to insert prefix digits (0 to 18).
	INSRT	Number of digits to insert.
	OPTSEL	Option select (LONGHAUL, SETCDN, or \$)
	CLLI	Common language name of a trunk group

ACRTE (continued)**Route selector refinements (Sheet 3 of 3)**

Entry in subfield RTESEL	Refinement	Explanation
T	ROUTATTR_INDEX	Index into table ROUTATTR containing expanded routing information.
	XLASYS	One of AC, AM, CT, FA, FT, NSC, OFC, or PX
	XLANAME	Valid name from head table of XLASYS
	RTEREF	Route reference index (1 to 1023)

The key to the route tables consists of the translation name (XLANAME) and the route reference (RTEREF). The route reference index corresponds to the destination number (from option DEST) used in the code table for a given XLANAME.

The entry in field RTELIST is the route list associated with the RTEREF. It consists of up to eight routes, each with a selector and data.

Route descriptions**CND — Conditional time-of-day route**

Time-of-day routing consists of a series of tables that are used to define time-of-day and day-of-week or day-of-year time spans. There can be a maximum of 16 possible time spans. If invoked, the time-of-day conditional selector (CND TOD) finds the number of the time set that the current time falls in. If there is a match between it and the times supplied in field TIMES, the conditional route specified in field CONDRTE is used. If there is no match, the next route list element is evaluated.

ACRTE (continued)

Time-of-day uses the following format:

- **TODNAME** — The name of the specified TOD system defined as a time-of-day name in field TOD in table TODHEAD.
- **TIMES** — A set of times that have been defined for the time-of-day name in field TOD in table TIMEODAY.
- The following table shows time-of-day datafill for table PXRTE. The time-of-day maps to 3 (field TIMES), then routes to list P621 8 (put the call over REPAIR_TRUNK).

PXRTE datafill

XLANAME	RTEREF	RTESEL	TODNAME	TIMES	CONDRTE	CLLI
P621	7	CND	REPAIR	3	ST8	
P621	8	S				REPAIR_TRUNK

CND — Network rerouting

This feature provides a method of controlling traffic through route list datafill by making use of any alternate routes to particular destinations.

If traffic congestion occurs, the route list is searched for. In the route list, the network rerouting conditional selector (CND NRR) executes the conditional instructions in field CONDRTE. If this route list is encountered due to normal overflow, the conditional instructions are not executed.

Note: The CND NRR option is not supported in GSM offices.

DCRT - Dynamically controlled routing

Dynamically controlled routing (DCR) is used in offices with the DCR feature as the first element of a route list. DCR in universal translations is controlled by the standard Software Optionality Control (SOC) option DCR00004. The SOC option for DCR in universal translations (DCR00004) depends on the DCR Base SOC option (DCR00001).

The DCRT selector blocks the call if the DCR destination of the call is one link away from the DMS-100 switch and the second leg of the DCR tandem recommendation is not available.

ACRTE (continued)

GBL- Global Selector

Global selector GBL is introduced in all the routing tables. The GBL has two optional selectors, either one of which can be datafilled under the GBL selector. The optional selectors are as follows:

- CCNTRLRX
 - CCNTLIDX provides an index into table CALLCNTL
 - UPDATE_BILL_CALLCODE is a boolean that decides whether the CALLCODE value obtained from the second leg of the call can be updated in the callcode field of the AMA billing record.
 - UPDATE_BILL_DESTNUM is a boolean that which decides whether destination digits from the second leg of the call can be updated in the destination address digits field of the AMA record.
 - UPDATE_BILL_NCOS_CUSTNAME is a boolean that decides whether NCOS and CUSTGRP values from the second leg of the call can be updated in the respective fields of the AMA record.
 - DMI accepts a datafill in the range of 0-32767 and provides an index into table DIGMAN. When the DMI field is datafilled as '0', digit manipulation is not performed.
- OUTP - used as a trigger to index into table OUTPULSE

N — Nonstandard route

A trunk is selected from the trunk group, and digits are outpulsed according to fields DELETE and PFXDIGS. The digits to prefix are outpulsed first, followed by the received digits, with the exception of the received prefix digits and the number of digits entered in field DELETE. The standard charging characteristics can be modified by field MODCHG.

The options of the MODCHG field are as follows:

- NOMOD — For this value, no charge modification is required. The zone, as calculated by translations, is used for billing.
- CANCHG — On a route that is normally chargeable, cancel the charge.

Note: This feature is not available at this time.

ACRTE (continued)

- CANTOLL — On a route that is normally chargeable, reduce the charge to a local charge.

Note: This feature is not available at this time.

- ADDCHG — On a normally free route, charge for the call based on the zone calculated by translations. This is implemented for terminations to announcement. This allows announcement billing as required.

Internationally agreed telephony standards allow for the inclusion, in an outpulsed digit address, of signals that define the particular type of operator to which the call terminates. The Code 11 forward signal requires the incoming call to route to an operator at the termination exchange. The Code 12 forward signal requires the incoming call to route to a special international operator. Such operators handle specific calls, for example, prebooked calls.

If code 11 (B) or 12 (C), is outpulsed, the data entered in field PRXDIGS must be enclosed by single quotation marks, and the character must be in upper case, for example '442B'.

The International Telecommunications Union (ITU) recommendations for communication between international exchanges allows for a language or a discrimination digit in the inter-register signals. The language digit indicates which language to use between operators in the international service. The language digit must be sent on all semiautomatic calls.

The language digits available for insertion are:

- 1 (French)
- 2 (English)
- 3 (German)
- 4 (Russian)
- 5 (Spanish)

The discrimination digit occupies the same location as the language digit. The following values are recognized:

- 0 (basic automatic call)
- 7 (test call)

NODE — Dynamically controlled routing node

The node routing selector is used in offices with the DCR feature. If the office is used as a DCR switch, routing proceeds to table DESTNODE, field DESTKEY, which is equal to field DESTNAME associated with this selector.

ACRTE (continued)

NOT — Network rerouting

The route list is searched for the not network rerouting (NOT NRR) conditional selector in the route list if congestion occurs. However, the conditional instructions are not executed, and the next route in the route list is attempted. As the NOT NRR selector appears as an entry in the route list, it can be indexed due to normal overflow. In this instance, the conditional instructions are executed, because congestion has not occurred.

NS - Non-standard routing (enhanced)

This selector has the ability to prefix, delete and skip upto 22 digits from the number to be outpulsed. The sub-fields of NS selector are as follows:

- **DEL_DIGS** - deletes the number of digits to be deleted from the called digits prior to outpulsing. It deletes up to 22 digits from the CdPN (Called Party Number).
- **PFX_DIGS** - specifies the digits to be PreFiXed to the called digits. It accepts a datafill in the range of 0 to 22.
- **PFX_AFTER** - specifies the number of digits to be skipped before PreFiXing. It accepts a number whose length is in the range of 0 to 22.

RT — Retranslation route

Retranslation uses the information provided in its refinement, which allows the system to change trunk routing and to do translations with a directory number in order to route to a line.

S — Standard route

A trunk is selected from the trunk group (by CLLI), and digits are outpulsed according to the standard outpulsing algorithm. This algorithm ignores prefix digits, and outpulses the rest of the received digits.

SG - Selector value option

Routes to a free trunk in a trunk group selected from those in the specified tuple in table SUPERTKG. Can also access table DIGMAN for digit manipulation functions. Additionally, the type of call (CALLTYPE) field is available. This field may be Public, Private, WATS, ASDS, LDS, Foreign exchange, TIE, or INWATS.

SO — Standard with options

Supports ETSI ISUP trunks. A trunk is selected from the trunk group (by CLLI), and digits are outpulsed after manipulation by the user. Digits may be deleted, prefix digits (referenced from table PFXDIGS) may be added at any position within the CLLI number, and the LONGHAUL or SETCDN option may be specified. The option determines whether the outgoing route is sufficiently long to activate an echo canceller device.

ACRTE (continued)**SX — Expanded standard route**

Expanded standard outpulsing algorithm. This algorithm ignores prefix digits, and outpulses the rest of the received digits.

T — Table name route

Route control is passed to the route list specified in fields XLASYS, XLANAME, and RTEREF, and further routes in the current route list are ignored. Currently, routing is limited to eight routes in a route list. The T selector makes it possible to chain together any number of route lists.

Datafill sequence and meaning

Table TRKSGRP must be datafilled before datafilling the universal translations route tables.

Table size

Memory is allocated dynamically. When the first tuple for a given XLANAME is added, table size is allocated to accommodate the given route reference. As tuples are added, the table increases to accommodate the largest route reference index.

Datafill

The following table lists datafill for table ACRTE.

Field descriptions (Sheet 1 of 4)

Field	Subfield	Entry	Explanation and action
XLANAME		alphanumeric (1 to 8 characters) or NIL	Translation name. Enter the name assigned to the corresponding translation system head table. This is the first part of a two-part key to table ACRTE.
RTEREF		numeric (1 to 1023)	Route reference. Enter the route reference index that corresponds to the destination (from option DEST) used in table ACCODE for the given XLANAME. This is the second part of a two-part key to table ACRTE.
RTELIST		see subfield	Route list. This field consists of subfield RTESEL and refinements dependent on the value in subfield RTESEL. The route list consists of up to eight routes, each route has a selector and data.

ACRTE (continued)

Field descriptions (Sheet 2 of 4)

Field	Subfield	Entry	Explanation and action
	RTESEL	CND, DCRT, GBL, GBL-CCNTL RX, GBL-OUTP, N, NS, NODE, NOT, RT, S, SG, SO, SX, T	<p>Route selector. Enter a maximum of eight of the following values.</p> <p>Enter CND (conditional route) and datafill refinements CONDITION and CONDRTE.</p> <p>If the route is conditional on the time-of-day (CND TOD), the call is transferred to the route list or element specified, if one of the times specified in field TIMES matches one of the times specified in table TIMEODAY.</p> <p>If a congestion message is received, the conditional network rerouting selector (CND NRR) of the universal routing tables is executed. The selector supports three types of conditional instructions, step (ST), skip (SK), and table (T).</p> <p>Note: The CND NRR option is not supported in GSM offices.</p> <p>If no conditional reroute selectors are found in the route list upon receipt of a congestion message, the call goes to treatment.</p> <p>Note: TOD routing consists of a series of tables that define time-of-day and day-of-week or day-of-year time spans. There can be a maximum of 16 possible time spans. If invoked, the TOD system finds the number of the set the current time falls in. If there is a match between it and the supplied TIMES set, TRUE is returned and the RTETYPE clause is executed. If FALSE is returned, the next route list element is evaluated.</p> <p>See table "PXRTE datafill" for an example for CND.</p>

ACRTE (continued)**Field descriptions (Sheet 3 of 4)**

Field	Subfield	Entry	Explanation and action
			<p>Enter DCRT (dynamically controlled routing tandem) as the first route selector and datafill refinements DCR_NETWORK, DESTNAME, and OSID. DCRT is used for DCR tandem calls that arrive on a DCR trunk group within the same network.</p> <p>Note: DCRT is datafilled only once in a route list.</p> <p>Enter N (non-standard route) and datafill refinements CLLI, MODCHG, DELETE, and PFXDIGS. A trunk is selected from the trunk group and the digits outpulsed according to fields DELETE and PFXDIGS. The digits to prefix are outpulsed first, followed by the received digits, with the exception of the received prefix digits and the number of digits given by field DELETE. The standard charging characteristics can be modified by field MODCHG.</p> <p>Enter NODE and datafill refinements DCR_NETWORK, DESTNAME, and OSID. NODE is used for DCR calls that are to be carried on an alternate (recommended) route.</p> <p>Note: NODE is datafilled only once in a route list.</p> <p>Enter NOT (network rerouting) and datafill refinements CONDITION and CONDRTE, if conditional instructions are not to execute when congestion occurs. Instead, the next route in the route list is attempted. Since selector NOT NRR (NOT) appears as an entry in the route list, it can be indexed due to normal overflow. In this instance, conditional instructions are executed, since congestion has not occurred.</p>

ACRTE (continued)

Field descriptions (Sheet 4 of 4)

Field	Subfield	Entry	Explanation and action
			<p>Enter RT (retranslation route) and datafill refinements RT_DIGITS, XLASYS, and XLANAME, if the digits received are replaced in their entirety by the number specified and then retranslated in the translation system specified. Retranslation is done using the information provided in the refinements. This allows the system to change trunk routing and to do translations with a directory number in order to route to a line.</p>
			<p>Enter S (standard route) and datafill refinement CLLI, if the route is standard. A trunk is selected from the trunk group (given by the common language location identifier (CLLI)) and digits are outputted according to the standard outputting algorithm. This algorithm ignores prefix digits, and outputs the rest of the received digits.</p>
			<p>Enter SG (super trunk group) and datafill refinements ALGRTHM, ATTNO, SGNAME, DMI, and CALLTYPE.</p>
			<p>Enter SO (Standard with options) and datafill refinement CLLI. SO allows datafill of subfield OPTSEL with either LONGHAUL (specifies that echo cancelling is required), SETCDN or \$ (no options selected). SO supports ETSI ISUP.</p>
			<p>Enter T (table name route) and datafill refinements TABNAME, XLASYS, XLANAME, and RTEREF, if the route is to route to a route table. Control is passed to the route list specified in the refinements. Further routes in the route list are ignored. This overcomes the restriction of having only eight routes in a route list by making it possible to chain together any number of route lists, each with up to eight routes.</p>

ACRTE (continued)**RTESEL = CND**

If the entry in subfield RTESEL is CND, datafill subfields CONDITION and CONDRTE, as described in the following table.

Field descriptions for conditional datafill

Field	Subfield	Entry	Explanation and action
	CONDITION	see subfields	Condition for routing. This refinement consists of subfield CNDSEL.
	CNDSEL	NRR or TOD	<p>Conditional selector. Enter TOD for the time-of-day and datafill subfields TODNAME and TIMES.</p> <p>Enter NRR to execute the CONDRTE instructions if congestion occurs.</p> <p>Note: The CND NRR option is not supported in GSM offices.</p> <p>The CNDSEL values: ALWAYS, CALLCHR, COSMAP, EA, INTERLATA, RND, SITE, SNPA, TOPEAALT, and TOPEAXFR, are not valid for universal translation RTE tables.</p>
	TODNAME	alphanumeric (1 to 8 characters)	Time-of-day name. Enter the name of the time-of-day system previously assigned in field TOD in table TODHEAD.
	TIMES	alphanumeric (0 to 9, A to F) (up to 14 characters)	Times set. Enter the times (maximum of 11 characters with no space between each time) when the transfer to another route list or element can occur. The time ranges are defined in table TIMEODAY, field TOD. If the current time is one of the times in the set, refinement CONDRTE is executed.

ACRTE (continued)

RTESEL = CND or NOT

If the entry in subfield RTESEL is CND or NOT, datafill subfield CONDRTE as described in the following table.

Field descriptions for conditional datafill (Sheet 1 of 3)

Field	Subfield	Entry	Explanation and action
	CONDRTE	see subfields	Conditional route. This refinement consists of subfield RTETYPE and its refinements.
	RTETYPE	SK, ST, T	Route type. Enter the route type. Enter NOT for network rerouting. Enter SK and datafill subfield SKIPNUM, if the call is to skip to another route element in the same route list. Enter ST and datafill subfield RTEREF, if the call is to transfer to another route list in the same table. Enter T and datafill subfields TABNAME, XLASYS, XLANAME, RTEREF, or TABNAME, and INDEX, if the call is to transfer to a route list in one of the universal translation route tables.
	SKIPNUM	numeric (0 to 7)	Skip number. If the entry in subfield RTETYPE is SK, datafill this refinement. Enter the number of elements within the same route list to skip in order for the call to transfer to the proper route if the condition is met.
	RTEREF	numeric (1 to 1023)	Route reference number. If the entry in subfield RTETYPE is ST, datafill this refinement. Enter the route reference number in the same table that the call is transferred to if the condition is met. The route reference number to which the call is transferred, must be a higher number than the route reference number from which it was transferred.

ACRTE (continued)**Field descriptions for conditional datafill (Sheet 2 of 3)**

Field	Subfield	Entry	Explanation and action
	TABNAME	IBNRTE, IBNRT2, IBNRT3, IBNRT4, IRTE, OFRT, OFR2, OFR3, OFR4, RRTE, TOPS	<p>Table name. If the entry in subfield RTETYPE is T, enter the respective office route table name.</p> <p>For all entries except IRTE, datafill subfield INDEX.</p> <p>If IRTE is entered, datafill subfields XLASYS and RTEREF.</p> <p>Note: The entries IBNRTE, IBNRT2, IBNRT3, IBNRT4, RRTE, and TOPS are not valid if subfield RTSEL is set to CND for all universal translation routing tables.</p>
	INDEX	numeric (0 to 1023)	<p>Route reference index. If the entry in subfield RTETYPE is T, and the entry in refinement TABNAME is any entry other than RRTE or IRTE, datafill this refinement. Enter the index of the route table to which the call is transferred.</p>
	XLASYS	AC, AM, CT, FA, FT, NSC, OFC, or PX	<p>Translation system. If the entry in subfield RTETYPE is T and the entry in refinement TABNAME is IRTE, datafill this refinement. Enter the translation system to which the call is transferred.</p> <p>Note: NIL is not a valid entry. NIL is only used to satisfy internal software functionality.</p>
	XLANAME	alphanumeric (1 to 8 characters)	<p>Translation name. If the entry in subfield RTETYPE is T and the entry in refinement TABNAME is IRTE, datafill this subfield. Enter the translation name of the table instance within the XLASYS to which the call is transferred.</p>

ACRTE (continued)**Field descriptions for conditional datafill (Sheet 3 of 3)**

Field	Subfield	Entry	Explanation and action
	RTEREF	numeric (1 to 1023)	Route reference index. If the entry in subfield RTETYPE is T and the entry in refinement TABNAME is IRTE, datafill this subfield. Enter the index of the route table specified to which the call is to transfer.
	KEY	numeric (0 to 1023)	Route reference key. If the entry in subfield RTETYPE is T, and the entry in refinement TABNAME is RRTE, datafill this subfield. Enter the index key of the route table to which the call is transferred.

RTESEL = DCRT or NODE

If the entry in subfield RTESEL is DCRT or NODE, datafill subfields DCR_NETWORK, DESTNAME, and OSID as described in the following table.

Field descriptions for conditional datafill

Field	Subfield	Entry	Explanation and action
	DCR_NETWORK	alphanumeric	DCR network. The network of the DCR destination node as defined in table DCRNETID.
	DESTNAME	alphanumeric	DCR destination node name. The destination node name is one of the names datafilled in table DESTKEY.
	OSID	numeric (1 to 55)	Outpulsing scheme identification. OSID is the index into table DESTNODE, field OSID to identify the outpulsing scheme defined in table DESTNODE.

ACRTE (continued)**RTESEL = GBL**

If the entry in subfield RTESEL is GBL, datafill subfields CCNTRLRX, OUTP as described in the following table.

Field descriptions for conditional datafill

Field	Subfield	Entry	Explanation and action
	CCNTRLRX	Refer to GBL-CCNTRLR X	Provides an index into table CALLCNTL retranslating the call.
	OUTP	Refer to GBL-OUTP	Indexes into table OUTPUTPULSE

RTESEL = GBL-CCNTRLRX

If the entry in subfield RTESEL is GBL-CCNTRLRX, datafill subfields CCNTLIDX, UPDATE_BILL_CALLCODE, UPDATE_BILL_DESTNUM, UPDATE_BILL_NCOS_CUSTNAME, and DMI as described in the following table..

Field descriptions for conditional datafill

Field	Subfield	Entry	Explanation and action
	CCNTLIDX	Any string predefined in table CALLCNTL.	
	UPDATE_BILL_C ALLCODE	Y/N	Determines whether the Callcode value is to be updated in the AMA record from the first leg of the call.
	UPDATE_BILL_D ESTNUM	Y/N	Determines whether the Destination digits are to be updated in the AMA record from the first leg of the call.
	UPDATE_BILL_N COS_CUSTNAM E	Y/N	Determines whether NCOS and Customer name are to be updated from the first leg of the call.
	DMI	0 - 32767	Indexes into table DIGMAN

ACRTE (continued)

RTESEL = GBL-OUTP

If the entry in subfield RTESEL is GBL-OUTP, datafill subfields CLLI, OUTPLS_IDX as described in the following table.

Field descriptions for conditional datafill

Field	Subfield	Entry	Explanation and action
	CLLI	Valid Trunk CLLI	Trunk on which the call terminates
	OUTPLS_IDX	0 - 1023	Indexes into table OUTPUTPULSE

RTESEL = N

If the entry in subfield RTESEL is N, datafill subfields CLLI, MODCHG, DELETE, PFXDIGS, and PFXAFTER as described in the following table.

Field descriptions for conditional datafill (Sheet 1 of 3)

Field	Subfield	Entry	Explanation and action
	CLLI	alphanumeric (1 to 16 characters)	Common language location identifier. Enter the common language location identifier (CLLI) of the trunk group to which the call is routed.
	MODCHG	ADDCHG, CANCHG, CANTOLL, NOMOD	<p>Modify charging. Enter one of the following values:</p> <p>Enter ADDCHG if the route is normally free and a charge is added based on the zone calculated by translation. This is only applied to terminations to announcements, allowing for announcement billing.</p>
	MODCHG		<p>Enter CANCHG if a route is normally chargeable and the charge is canceled.</p> <p>Note: This feature is not presently available.</p> <p>Enter CANTOLL if a route is normally chargeable and the charge is reduced to a local charge.</p> <p>Note: This feature is not presently available.</p> <p>Enter NOMOD if no charge modification is required. The zone, as calculated by translations, is used for billing.</p>

ACRTE (continued)**Field descriptions for conditional datafill (Sheet 2 of 3)**

Field	Subfield	Entry	Explanation and action
	DELETE	numeric (0 to 18)	Delete digits. Enter the number of digits to be deleted before outpulsing.
	PFXDIGS	alphanumeric (1 to 12 characters)	<p>Prefix digits. Enter prefix digits in the range 0 to 9 and/or N, or code 11, or code 12. 'N' represents the Hex A, Code 11 represents Hex B, and code 12 represents Hex C. If the data entered in this refinement contains either B or C, the data must be enclosed by single quotation marks and the letters must be in upper case, for example, '442B'.</p> <p>Digit 'N' is datafilled as a valid digit that represents digit 'A' in universal translations so that all overdecadic digits ('0' to 'F') can be datafilled together with other digits. A single 'N' means that no digits will be prefixed.</p> <p>Note: Internationally agreed telephony standards allow for the inclusion, in an outpulsed digit address, of signals that define the particular type of operator to which the call terminates. The Code 11 forward signal requires the incoming call to route to an operator at the terminating exchange. The Code 12 forward signal requires the incoming call to route to a special international operator. Such operators handle specific calls, for example, prebooked calls.</p>

ACRTE (continued)

Field descriptions for conditional datafill (Sheet 3 of 3)

Field	Subfield	Entry	Explanation and action
	PFXDIGS		<p>Note: ITU recommendations for communication between international exchanges allow for a language or discrimination digit in the interregister signals. The language digit indicates the language to use between operators in international service. The language digit must be sent on all semiautomatic calls.</p> <p>The following language digits are available for insertion:</p> <ul style="list-style-type: none"> • 1 (French) • 2 (English) • 3 (German) • 4 (Russian) • 5 (Spanish) <p>The following discrimination digits occupy the same location as the language digit:</p> <ul style="list-style-type: none"> • 0 (basic automatic call) • 7 (test call)
	PFXAFTER	numeric (0 to 15)	Specifies the number of leading digits after which to insert prefix digits. Enter the number of leading digits to skip before inserting the digits specified in subfield PFXDIGS.

RTESEL = NS

If the entry in subfield RTESEL is NS, datafill subfields CLLI, DEL_DIGS, PFX_AFTER and PFX_DIGS as described in the following table.

Field descriptions for conditional datafill (Sheet 1 of 2)

Field	Subfield	Entry	Explanation and action
	CLLI	numeric (1 to 11 digits)	Enter CLLI that specifies the Common Language Location Identifier of a valid trunk.
	DEL_DIGS	0 to 22	Delete digits. Enter the number of digits to be deleted up to 22 digits from the CdPN.

ACRTE (continued)**Field descriptions for conditional datafill (Sheet 2 of 2)**

Field	Subfield	Entry	Explanation and action
	PFX_AFTER	0 to 22	Specifies the number of leading digits after which to insert prefix digits. Enter the number of leading digits to skip up to 22 digits.
	PFX_DIGS	Any number with a length in the range 0 to 22	Prefix digits. Enter the number of digits to be prefixed up to 22 digits to CdPN (Called Party Number).

RTESEL = RT

If the entry in subfield RTESEL is RT, datafill subfields RTDIGITS, XLASYS, and XLANAME as described in the following table.

Field descriptions for conditional datafill

Field	Subfield	Entry	Explanation and action
	RT_DIGITS	numeric (1 to 11 digits)	Digits to retranslate. Enter the digits that are retranslated in the appropriate translation system or table and replace the digits dialed.
	XLASYS	AC, AM, CT, FA, FT, NSC, OFC, or PX	Translation system. Enter the translation system that the digits are transferred to for retranslation. Note: NIL is not a valid entry. NIL is only used to satisfy internal software functionality.
	XLANAME	alphanumeric (1 to 8 characters)	Translation name. Enter the translation name of the table instance within the translation system to which the retranslated digits are transferred.

RTESEL = S

If the entry in subfield RTESEL is S, datafill subfield CLLI as described in the following table.

Field descriptions for conditional datafill

Field	Subfield	Entry	Explanation and action
	CLLI	alphanumeric (1 to 16 characters)	Common language location identifier. Enter the CLLI of the trunk group to which the call is routed.

ACRTE (continued)**RTESEL = SG**

If the entry in subfield RTESEL is SG, datafill subfields ALGRTHM, ATTNO, SGNAME, DMI, and CALLTYPE as described in the following table.

Field descriptions for conditional datafill (Sheet 1 of 2)

Field	Subfield	Entry	Explanation and action
	ALGORITHM	CYC or RND	Enter CYC to set the algorithm to cyclical. The first trunk group to be tested is selected in sequence for each call routing through the super-group. Enter RND to set the algorithm to random. The first trunk group to be tested is selected at random for each call routing through the super-group.
	ATTEMPTS	numeric (1 to 220)	Attempt number. Enter the maximum number of trunk groups to be tested for a free trunk member.
	SUPERTKG_ NAME	alphanumeric (1 to 16 characters)	Enter the name of the super-group.
	OPTIONS	OPTION	Enter up to two options (see datafill subfields DMI and CALLTYPE).

ACRTE (continued)**Field descriptions for conditional datafill (Sheet 2 of 2)**

Field	Subfield	Entry	Explanation and action
	CALLTYPE	PUBLIC, PriVaTe, WATS, ASDS, LDS, Foreign eXchange, TIE, INWATS	<p>Call Type. This subfield allows for switching of routing call-types on an as-needed basis.</p> <ul style="list-style-type: none"> Enter PUB for public routing of calls. Operator Access Type (OATYPE) has options (NONE, 0M, 0P). Transit Network Selector (TNS) has values (0 to 999, N, C). NPOS has values N, Y. Enter PVT for private routing of calls. Facility Number (FACNUM) has values 0 to 1023. Numbering Plan Indicator (NPI) has values E164 and PVT. Enter WATS for WATS routing of calls. Zone. Zone is ZONE_TYPE. Numbering Plan Indicator (NPI) has values E164 and PVT. CARRIER IS VECTOR OF UP TO 1 IC_INC_CARRIER_NAME'S. Enter ASDS for ASDS routing of calls. Numbering Plan Indicator (NPI) has values E164 and PVT. Enter LDS for LDS routing of calls. Numbering Plan Indicator (NPI) has values E164 and PVT. Enter FX for foreign exchange routing of calls. Facility Number (FACNUM) has values 0 to 1023. Numbering Plan Indicator (NPI) has values E164 and PVT. Enter TIE for TIE routing of calls. Facility Number (FACNUM) has values 0 to 1023. Numbering Plan Indicator (NPI) has values E164 and PVT. Enter INWATS for INWATS routing of calls. Facility Number (FACNUM) has values 0 to 1023. Numbering Plan Indicator has values E164 and PVT.
	DMI	numeric (1 to 32 767)	Enter DMI and the index number to table DIGMAN. This option allows the called number characteristics to be manipulated by the action of table DIGMAN.

ACRTE (continued)**RTESEL = SO**

If the entry in subfield RTESEL is SO, datafill subfields DEL, AFTER, INSRT, and OPTSEL as described in the following table.

Field descriptions for conditional datafill

Field	Subfield	Entry	Explanation and action
	CLLI	alphanumeric (1 to 16 characters)	Common language location identifier. Enter the CLLI of the trunk group to which the call is routed.
	DEL	0 to 18	Delete digits. Enter the number of digits to be deleted before outpulsing.
	AFTER	0 to 18	Number of leading digits after which to insert prefix digits. Enter the number of leading digits to skip before inserting the prefix digits specified in subfield PFXDIGS.
	INSRT	N or 1 to 11 digits	Number of digits to insert prefix digits. Enter the number of digits.
	OPTIONS		see subfield OPTSEL
	OPTSEL	LONGHAUL, SETCDN, or \$	Enter LONGHAUL to determine if the outgoing route is sufficiently long to activate an echo cancelling device. Enter SETCDN which has one subfield (CDNNAME) as defined in table CDNCHAR. The CDNNAME must be present in table CDNCHAR before the SETCDN option is datafilled. If the option is encountered for the selected route, then the specified CDNNAME determines the characteristic to use in the outgoing message. The SETCDN option in this selector can be used with any of the trunk types supported in table CDNCHAR.
	CDNNAME		Enter a valid CDNNAME from table CDNCHAR to define the outgoing call characteristics used.

ACRTE (continued)**RTESEL = SX**

If the entry in subfield RTESEL is SX, datafill subfields CLLI and ROUTATTR_INDEX as described in the following table.

Field descriptions for conditional datafill

Field	Subfield	Entry	Explanation and action
	CLLI	alphanumeric (1 to 16 characters)	Common language location identifier. Enter the CLLI of the trunk group to which the call is routed.
	ROUTATTR_ INDEX	alphanumeric (up to 16 characters)	Route attribute index. Enter the index into table ROUTATTR containing the expanded routing information to be applied to the call.

ACRTE (continued)

RTESEL = T

If the entry in subfield RTESEL is T, datafill subfields TABNAME, XLASYS, XLANAME, RTEREF, and INDEX as described in the following table.

Field descriptions for conditional datafill (Sheet 1 of 2)

Field	Subfield	Entry	Explanation and action
	TABNAME	IBNRTE, IBNRT2, IBNRT3, IBNRT4, IRTE, OFRT, OFR2, OFR3, OFR4, OVRx (where x is 0 to 89) RRTE, TOPS	<p>Table name. If the entry in subfield RTESEL is T, enter the respective office route table name.</p> <p>If RRTE is entered, datafill refinements INDEX and KEY for all entries except IRTE.</p> <p>If IRTE is entered, datafill refinements XLASYS and RTEREF.</p> <p>Note: The entries IBNRTE, IBNRT2, IBNRT3, IBNRT4, and RRTE are not valid if subfield RTESEL is set to T in all universal translation routing tables. The entry TOPS is only valid for tables CTRTE, FARTE, FTRTE, OFCRTE, and PXRTE when RTESEL is set to T. The entry TOPS is not valid for table AMRTE or ACRTE.</p> <p>Note: Table OVRx must be datafilled before tables xxRTE (where xx is AC, PX, CT, FA, NSC, OFC, or FT), IBNRTE, IBNRT2, IBNRT3, IBNRT4, OFR2, OFR3, OFR4, or OFRT.</p>
	INDEX	numeric (0 to 1023)	<p>Route reference index. If the entry in refinement TABNAME is any entry other than IRTE, RRTE, or TOPS datafill this subfield.</p> <p>Enter the index of the route table (0 to 1023) to which the call is routed.</p>
	XLASYS	AC, AM, CT, FA, FT, NSC, OFC, PX	<p>Translation system. If the entry in refinement TABNAME is IRTE, datafill this subfield. Enter the translation system to which the call is transferred.</p> <p>Note: NIL is not a valid entry. NIL is used only to satisfy internal software functionality.</p>

ACRTE (continued)**Field descriptions for conditional datafill (Sheet 2 of 2)**

Field	Subfield	Entry	Explanation and action
	XLANAME	alphanumeric (1 to 8 characters)	Translation name. If the entry in refinement TABNAME is IRTE, datafill this subfield. Enter the translation name of the table instance within the XLASYS to which the call is transferred.
	RTEREF	numeric (1 to 1023)	Route reference index. If the entry in refinement TABNAME is IRTE, datafill this subfield. Enter the index of the route table specified to which the call is transferred.
	KEY	numeric (0 to 1023)	Route reference key. If the entry in subfield TABNAME is RRTE, datafill this subfield. Enter the index key of the route table to which the call is transferred.
	INDEX	alphanumeric (1 to 8 characters)	Call origination index. If the entry in subfield TABNAME is TOPS, enter the call origination index. The call origination (CO) type index entered must be datafilled in table TOPS.

Datafill example

The figure that follows shows sample datafill for table ACRTE.

MAP display example for table ACRTE

XLANAME	RTEREF	RTELIST
XLA1	555	(T OFR2 10)\$
IXLA	3	(CND NRR T IRTE PX IXLA 44) (NOT NRR ST 7) (S CLLI3)\$

The following example shows sample datafill for table ACRTE with Dynamically Controlled Routing (DCR). DCR in universal translations is controlled by SOC option DCR00004. This option can be activated either before or after the datafill of the DCR selectors in table ACRTE.

ACRTE (continued)

MAP display example for table ACRTE with DCR

XLANAME	RTEREF	RTELIST
XLA1	951	(NODE DCRNET2 NODE1 11) (N NET2_5TO4_OG NOMOD 3 974 0) (T OFR2 851) \$
XLA2	952	(NODE DCRNET2 NODE2 12) (N NET2_5TO4_OG NOMOD 3 974 0) (T OFR2 852) \$
XLA3	953	(NODE DCRNET2 NODE3 13) (N NET2_5TO4_OG NOMOD 3 974 0) (T OFR2 853) \$
XLA4	954	(DCRT DCRNET2 NODE4 14) (N NET2_5TO4_OG NOMOD 4 6211 0) (NODE DCRNET2 NODE4 14) (T OFR2 754) \$

The examples that follow show sample datafill for table PXRTE with selector SG option DMI, selector N option NBCDEF, selector GBL option CCNTRLRX, selector GBL option OUTP and selector NS.

MAP display example for table PXRTE selector SG option DMI

XLANAME	RTEREF	RTELIST
696	34	(SG CYC 10 SGRP1 (DMI 10350 \$) \$

MAP display example for table PXRTE selector N option NBCDEF

XLANAME	RTEREF	RTELIST
LNSTART	103	(N EISUPV2A NOMOD 0 NBCDEF 0) \$

ACRTE (continued)**MAP display example for table PXRTE selector GBL option CCNTRLX**

XLANAME	RTEREF	RTELIST
KNGA10PX 280 (GBL CCNTRLX SET_NCOS Y Y Y 123) \$		

MAP display example for table PXRTE selector GBL option OUTP

XLANAME	RTEREF	RTELIST
KNGA10PX 200 (GBL OUTP KNGA280EIBWE 5) \$		

MAP display example for table PXRTE selector NS

XLANAME	RTEREF	RTELIST
KNGA10PX 200 (NS KNGA280EIBWE 1 91 2) \$		

MAP display example for table ACRTE selector SG

XLANAME	RTEREF	RTELIST
TEST1 2 (SG CHCL 5 TEST1 (CALLTYPE PUB NONE 0 N) \$) \$		

For additional route table examples, refer to table ACHEAD.

Table history**NA017**

The SG selector is extended to include a CALLTYPE field that permits customers to select a PUBLIC, PRIVATE, WATS, ASDS, LDS, Foreign eXchange, TIE, or INWATS calltype per feature activity 59035336.

ACRTE (end)

Added 'N' selector (NS) and global selector (GBL) to all the routing tables for activity 59028782.

MMP16

Added explanation in routing selector option N subfield PFXDIGS for digit 'N' to be datafilled that represents digit 'A' in Universal translations for activity 59028026.

MMP15

OVRx was added as an entry to subfield TABNAME.

MMP14

Added subfield OPTIONS and option DMI for the SG selector.

MMP13

Added SETCDN to OPTIONS subfield for SO selector.

EUR008

Added routing selector option SG to subfield RTESEL.

EUR006

The SO option indicating the LONGHAUL routing option was added to subfield RTESEL.

TL07

DCR selectors DCRT and NODE were added as entries to subfield RTESEL.

ACTCTL

Table name

The XPM Activity Controller Table

Functional description

The CCITT Signaling System R2 uses register signaling to transfer information about a call between two ends of a trunk. The R2 systems are multifrequency compelled (MFC) systems. The R2 systems sends tones in one direction and return acknowledgement tones. A protocol specification describes the information transferred.

The R2 signaling applies to the DMS-100, DMS-200, and DMS-100/200 switches.

Table ACTCTL defines the R2 activities for a protocol that includes control of the extended multiprocessor system (XMS)-based peripheral module (XPM) processor targets and phase changes.

Each protocol has two ACTCTL tuples entered. The tuples provide signaling control. One tuple is for incoming trunks. The other tuple is for outgoing trunks.

The central control maintains and downloads table ACTCTL for NT-40. The DMS-core maintains and downloads table ACTCTL for SuperNode. The XPM uses table ACTCTL.

A group of an R2 activity and a character string index table ACTCTL. The character string corresponds to the set of incoming and outgoing signals that table R2PROT uses.

Datafill sequence and meaning

You do not have to enter data in other tables before you enter data in table ACTCTL.

Table size

0 to 7680 tuples

The table allocates a maximum of 256 tuples for each variant activity to control task mapping. Each office can have a maximum of 30 defined mappings.

ACTCTL (continued)

Datafill

Datafill for table ACTCTL appears in the following table.

Field descriptions (Sheet 1 of 2)

Field	Subfield or refinement	Entry	Explanation and action
INDEX		see subfields	<i>Index.</i> This field contains subfields CTRLNAME and ACTIVITY. This field represents the index to table ACTCTL.
	CTRLNAME	alphanumeric (1 to 8 characters)	<i>Controller name.</i> Enter the controller name.
	ACTIVITY	alphanumeric (to a maximum of 18 characters)	<i>R2 activity.</i> Enter the name of the R2 activity. See table SIGACT for the list of activity entries.

ACTCTL (continued)**Field descriptions (Sheet 2 of 2)**

Field	Subfield or refinement	Entry	Explanation and action
RSTPRCID		GENERAL NO_ CHANGE IC01_DGT IC01_ANI OG01_DGT OG01_ANI IC01_SOC IC02_DGT OG01_SOC OG02_DGT IC02_SOC OG02_ANI IG03_ANI IC02_ANI or OG01_REQ	<i>Register signaling transactor processor identification.</i> Enter the register signaling transactor (RST) state processor code.
PHASE		NO_ CHANGE PHASE_0 PHASE_1 PHASE_2 PHASE_3 PHASE_4 PHASE_5 PHASE_6 PHASE_7 PHASE_8 PHASE_9 PHASE_10 PHASE_11 PHASE_12 PHASE_13 or PHASE_14	<i>R2 phase.</i> Enter the phase to change to after the activity completes.

Datafill example

Sample datafill for table ACTCTL appears in the following example.

ACTCTL (end)

MAP example for table ACTCTL

INDEX	RSTPRCID	PHASE
BELCTLI DIGIT_1	NO_CHANGE	NO_CHANGE
BELCTLI DIGIT_2	NO_CHANGE	NO_CHANGE
BELCLTO REGULAR	NO_CHANGE	PHASE_2

Table history

BCS34

Table ACTCTL was introduced in BCS34.

Additional information

This section provides information on datafilling table ACTCTL for specified applications. This section provides product description information that relates to table ACTCTL.

Enter each R2 activity in table ACTCTL to define the R2 activity for a specified protocol. The exception to this rule is activity LAST_DIGIT. When LAST_DIGIT appears against the incoming ACTCTL index of that protocol, the system records LAST_DIGIT as defined and correct for a protocol.

If a protocol requires an identical mapping already entered, do not define a new tuple. More than one protocol can use the ACTCTL index.

ACTPATCH

Table name

Activatable Patches

Functional description

Table ACTPATCH displays the status of all computing module (CM) applied activatable patches. This table is a read-only table. You cannot add tuples to this table. You cannot delete tuples from this table. You cannot change the tuples in this table. This table is a requirement during the One Night Process (ONP).

Use the PATCHEDIT/SELECT command to find the status of all activatable patches. Table ACTPATCH changes as PATCHEDIT/ASSIGN changes the status of patches.

This table interacts with PATCHER/PRISM.

Datafill sequence and implications

You do not have to enter data in other tables before you enter data in table ACTPATCH.

Table size

Does not apply

Datafill

Datafill for table ACTPATCH appears in the following table.

Field descriptions

Field	Subfield or refinement	Entry	Explanation and action
PATCHID		alphanumeric (vector of a maximum of 32 characters)	Patch identification. This field displays all activatable patches. The patch identifications are a maximum of 32 characters in length.
STATUS		OFF, ON or NA	Status. This field displays the status of all CM activatable patches. Possible entries include OFF, ON and NA (no audit).

Datafill example

Sample datafill for table ACTPATCH appears in the following example.

ACTPATCH (end)

MAP example for table ACTPATCH

	PATCHID	STATUS
VAB05B34		ON
AMC85B34		ON

Table history

CSP04

This read-only table was introduced to meet information requirements for the ONP in CSP04.

ACTSIG

Table name

XPM Activity to Signal Mapping Table

Functional description

The CCITT Signaling System R2 (R2) uses register signaling to transfer call information between two ends of a trunk. The R2 systems are multifrequency compelled (MFC) systems that send tones in one direction on a trunk link. Acknowledgment tones return in the opposite direction on the trunk link. A protocol specification describes the information that transfers.

The R2 signaling systems apply to DMS-100, DMS-200, and DMS-100/200 switches.

Table ACTSIG maps R2 activities to facility signals (MFC tones) for each phase of a protocol. The system accesses table ACTSIG before the system sends a signal to another office.

Each protocol has a number of ACTSIG tuples entered to provide activity-to-signal mapping. Each phase of a protocol in table R2PROT has one set of tuples with the same value defined in field TUPLENO.

The following features maintain and download table ACTSIG:

- central control (for NT-40)
- DMS-core (for SuperNode)

The extended multiprocessor system (XMS)-based peripheral module (XPM) uses this table.

An index from table R2PROT, and an activity identifier references table ACTSIG.

See table ACTCTL for additional information.

Datafill sequence and meaning

You do not need to enter data in other tables before you enter data in table ACTSIG.

Table size

0 to 32 767 tuples

Each variant activity requires a maximum of 256 tuples to signal mapping. Each office can contain a maximum of 256 variant mappings.

ACTSIG (continued)

Datavill

The datavill for table ACTSIG appears in the following table.

Field descriptions

Field	Subfield or refinement	Entry	Explanation and action
INDEX		see subfields	<i>Index.</i> This field contains subfields TUPLENO and ACTIVITY. This field is the index to table ACTSIG.
	TUPLENO	numeric (1 to 255)	<i>Tuple number.</i> Enter the tuple number. The entry 0 (zero) is reserved for the NIL tuple. Only the DMS software uses this tuple.
	ACTIVITY	alphanumeric (1 to 18 characters)	<i>R2 activity.</i> Enter the name of the R2 activity. See table SIGACT for the list of activity entries.
SIGNAL		numeric (1 to 15)	<i>Signal.</i> Enter the signal number.

Datavill example

Sample datavill for table ACTSIG appears in the following example.

MAP example for table ACTSIG

INDEX	SIGNAL
0 CONGESTION	3
0 UNASSIGN_NUM	5
0 SUBBUSY	1
1 CONGESTION	3
1 UNASSIGN_NUM	5
1 SUBBUSY	1

Table history

BCS34

Table ACTSIG was introduced in BCS34.

Additional information

The following information appears in this section:

- how to enter table ACTSIG for specified applications
- product description information related to table ACTSIG.

R2 activities

You must enter each R2 activity in table ACTSIG to identify the activity. This action identifies each activity as a correct signal to generate for a protocol. The system generates these signals for each phase of activity. This rule applies to incoming and outgoing trunks.

Mapping required by protocol

A protocol can require mapping that is identical to a mapping already entered. When this condition occurs, do not enter a new tuple. More than one protocol can use the ACTSIG index.

ACTTRTMT

Table name

Activity to Treatment Mapping Table

Functional description

The CCITT Signaling System R2 (R2) uses register signaling to transfer information about a call between the two ends of a trunk. The R2 signaling applies to the DMS-100 and DMS-200 switches.

Table control software uses the R2 activity tables. The table control software is a requirement to input the protocol specification in the DMS-100 and DMS-200 switches.

The following features use table ACTTRTMT:

- central control (NT-40 switches)
- DMS-code (SuperNode switches)

Table ACTTRTMT provides a translation from an R2 activity to an extended treatment. Outgoing R2 multifrequency compelled (MFC) signaling trunks require this table.

A treatment index (TRTMTIDX) and an activity identifier index table ACTTRTMT. The treatment index is in tables TRKGRP (selector MTR and OPR) and TRKSGRP (signaling selector FST). The activity identifier corresponds to the received signal. Table ACTTRTMT returns a treatment identifier that determines if treatment must occur in the previous or local office.

Each protocol has one ACTTRTMT tuple to provide the required mappings. If an activity is not entered in the table, the default is reorder (RODR).

A list of correct R2 activities for table ACTTRTMT appears in the following table.

Correct R2 activities for table ACTTRTMT (Sheet 1 of 2)

R2 activity	Description of activity
CONGESTION	Congestion in network
SUB_BUSY	Subscriber line is busy
SUB_OUT_ORD	Call number is out of order

ACTTRTMT (continued)**Correct R2 activities for table ACTTRTMT (Sheet 2 of 2)**

R2 activity	Description of activity
SUB_XFRD	Subscriber transferred
TEMP_OUT_ORD	Temporarily out of order
UNASSIGNED_NUM	Called number is not assigned
SUB_LBUSY	Called subscriber busy in a local call
SUB_TBUSY	Called subscriber busy in a toll call
SPARE_TRTMT1	Spare

Datafill sequence and meaning

You do not need to enter data in other tables before you enter data in table ACTTRTMT.

Table size

0 to 3840 tuples

The number of tuples you add dynamically determines the table size. Each variant signal requires a maximum of 16 tuples to perform activity mapping. You can define a maximum of 256 mappings for each office.

Datafill

The datafill for table ACTTRTMT appears in the following table.

Field descriptions (Sheet 1 of 2)

Field	Subfield or refinement	Entry	Explanation and action
INDEX		see subfields	<i>Activity index.</i> This field contains subfields TRTNAME and ACTIVITY.
	TRTNAME	alphanumeric (a maximum of 8 characters)	<i>Treatment mapping name.</i> Enter the treatment mapping name assigned to the R2 activity. Field TRTMTIDX in tables TRKGRP (selector MTR or OPR) and TRKSGRP (signaling selector FST) indexes field TRTMTIDX.

ACTTRTMT (end)

Field descriptions (Sheet 2 of 2)

Field	Subfield or refinement	Entry	Explanation and action
TRTMT	ACTIVITY	see list in table Table , "Correct R2 activities for table ACTTRTMT" on page -252	<i>R2 activity.</i> Enter the name of the required R2 activity. See table Table , "Correct R2 activities for table ACTTRTMT" on page -252 for a complete list of correct R2 activities.
		alphanumeric (4 characters)	<i>Treatment.</i> Enter the name of the extended treatment assigned to the R2 activity. See the description of table TMTCNTL for a complete list of extended treatments.

Datafill example

Sample datafill for table ACTTRTMT appears in the following example.

MAP example for table ACTTRTMT

INDEX	TRTMT
MORTRTT CONGESTION	NBLH
MORTRTL UNASSIGNED_NUM	VACT
SOCTRRT SUB_BUSY	BUSY

ADJNODE

Table name

Adjacent Node (ADJNODE)

Functional description

Table ADJNODE allows access to information about the type of software running in the adjacent node. The ADJNODE field in table TRKSGRP indexes into this table. ISUP, transaction user part, and primary rate interface trunk types use table ADJNODE.

Table ADJNODE flexibility allows different datafilling scenarios. The most logical method assigns a single tuple to each node. Each trunk subgroup connected to a particular far-end, points to the tuple for that node. The ADJNODE tuple can be modified when far-end software is upgraded without requiring changes to the tuple in table TRKSGRP.

Datafill sequence and implications

There is no requirement to datafill other tables prior to table ADJNODE.

The following tables must be datafilled in the order listed after table ADJNODE.

- TRKSGRP
- ISUPDEST
- TRKMEM
- C7TRKMEM

Table size

Table ADJNODE contains up to 16,384 tuples.

ADJNODE (continued)**Field descriptions**

The following table describes field names, subfield names, and valid data ranges for table ADJNODE.

(Sheet 1 of 2)

Field	Subfield or refinement	Entry	Explanation and action
ADJNODEK		ADJNODE_KEY and a vector of up to 12 characters	ADJACENT NODE KEY. Enter the name assigned to each of the adjacent switches. Clearly define the office represented.
SIGDATA		ISUP, PRA	SIGNALING TYPE. Enter the type of signaling performed on each trunk subgroup connected with the site: <ul style="list-style-type: none"> • Enter ISUP for Integrated Services Digital Network User Part. • Enter PRA for Primary Rate Access.
PRA	PRODUCT	OTHER, DMS, SL1, SYS85, ESS4, ESS5, ETSIPRA, AUSTPRA, INS1500	PRODUCT TYPE. These values display only when PRA is entered as the signaling type. Enter the product type of the adjacent switch.

ADJNODE (continued)

(Sheet 2 of 2)

Field	Subfield or refinement	Entry	Explanation and action
ISUP	PRODUCT	OTHER, DMS, SL1, SYS85, SIEMENS, FUJITSU, IBMROLM, NEC, ERICSSON, GTE, STROMBERG-CARLSON, ROCKWELL, DEX, ESS4, ESS5, ESS1A, SYSTEMX, DSC, DMS250, DMS300, DMSNCS, DMSISN, SL100, BELLCORDSTD	PRODUCT TYPE. These values display only when ISUP is entered as the signaling type. Enter the type of product in the adjacent switch. If this field is set to DMS300, then the far-end switch is a DMS-300, and all calls inbound from a DMS-300 switch by way of an ISUP IMT generate a billing record regardless of the value of the office parameter CDR_FOR_ISUP.
OPTIONS		Vector of up to 32 adjacent ISUP option elements	<p>ADJACENT ISUP OPTIONS VECTOR. Enter one the following options:</p> <ul style="list-style-type: none"> • NOCQT - circuit query test disabled • NOGRPBLK - circuit group blocking disabled • AUTOCON -automatic congestion control enabled • NOCVT -circuit validation testing disabled • NOPNET - switched computer application interface private network supported • NONSTDREDIR - nonstandard redirection indicator • BLUEBOOK - CCITT bluebook applicable <p>Note: AUTOCON, NOPNET, and BLUEBOOK options display only when the applicable software feature packages are active.</p>

Datafill example

The following example shows datafill for table ADJNODE.

ADJNODE (end)

ADJNODEK	SIGDATA		SIGDATA
DMS300	ISUP	DMS300	(NOGRPBLK) \$

AKEYTAB

Table name

Access Key table

Functional description

Table AKEYTAB preserves the relationship between integrated link maintenance (ILM) access_keys and device mtce_ids over batch change supplement (BCS) applications.

The system restricts direct access to the table. Subscribers have read-only access. To gain indirect access, the subscriber can enter a device that requires resources that ILM supports. Indirect access can occur as part of a restore operation on the N + 1 BCS, as part of a BCS application.

Datafill sequence and meaning

This section does not apply. The table is write-protected against direct datafill.

Table size

0 to 1024 tuples. The number of tuples dynamically determines the table size.

AKEYTAB (continued)

Datafill

The datafill for table AKEYTAB appears in the following table.

Field descriptions (Sheet 1 of 2)

Field	Subfield or refinement	Entry	Explanation and action
AKEY		0 to 1023	<p><i>Access key.</i> This tuple is the identifier that ILM uses to identify a group of accesses. The processing entity maintenance (PEM) considers these accesses as related.</p> <p>An access is a location where processing entities can access transport facilities. Transport facilities include a port or link interface, or a bus tap. The ILM uses access_ids as a form of identifier for these access points because ILM interacts with different maintenance subsystems. The ILM does not have to know all the names that connecting maintenance systems have for transport facility interfaces.</p> <p>The PEM determines when the system reassigns each access in the set an access_index. The selection of index does not affect the ILM. The ILM uses this index to identify the access when the ILM communicates with other maintenance subsystems.</p> <p>The system allocates this access key when you enter a PEM device.</p>
MTCEID		see subfields	<p><i>Maintenance identifier.</i> This tuple is an identifier for a resource. This tuple is constant over BCS applications. This tuple is a multiple with two fields: DISC and NUM.</p>

AKEYTAB (continued)

Field descriptions (Sheet 2 of 2)

Field	Subfield or refinement	Entry	Explanation and action
	DISC	0 to 255	<p><i>Maintenance discriminator.</i> The maintenance discriminator performs the following operations:</p> <ul style="list-style-type: none"> identifies the different areas of maintenance responsibility routes requests from general maintenance software to software for an application, like a peripheral <p>In an MTCEID, the DISC field refers to the maintenance subsystem that contains the resource.</p>
	NUM	0 to 511	<p><i>MTCEID resource number.</i> This MTCEID resource number contains identifiers that specify one of the resources that a maintenance subsystem contains.</p>

Datafill example

Sample datafill for table AKEYTAB appears in the following example.

MAP example for table AKEYTAB

AKEY	MTCEID
0	3 0
1	3 1
2	4 0
3	4 1
4	4 2

Table history**BCS26**

Table AKEYTAB was introduced in BCS26.

AKEYTAB (end)

Additional information

Restore table AKEYTAB before you restore the inventory tables of the devices that require ILM resources. These tables are APINV, LIMINV, LIUINV, and NIUINV.

ALARMTAB

Table name

Threshold Alarms Table

Overview

The operational measurements (OM) threshold alarm tables, ALARMTAB and OMTHRESH, have identical functions, except ALARMTAB is a read-only table and OMTHRESH is a read-write table. Only thresholding of OMs is allowed. Thresholding of log reports is no longer supported. Threshold count in table ALARMTAB is done at intervals of 1 min. In table OMTHRESH the time period is specified by the operating company. If the threshold limit is exceeded, an alarm of the specified severity is generated. Log report OM2200 is also generated for downstream processing.

Once an alarm is generated for a specific entry in the table, alarm generation for the entry is suppressed for 15 min.

Functional description

Table ALARMTAB is write-protected and datafilled in advance by the system. Any additions or changes (no deletions) to this table can be made through Northern Telecom's technical support personnel.

Each record in table ALARMTAB refers to a specific OM register. In addition, a threshold value, scan time, and an alarm level (critical, major, minor, or no alarm) is specified. The threshold represents the amount an OM register must be incremented during the scan period (normally 1 min) to activate the associated alarm.

When an alarm is activated for an OM, log report OM2200 is also generated.

Datafill sequence and implications

Table TMINV must be datafilled before table ALARMTAB.

Table size

0 to 128 tuples

ALARMTAB (continued)**Datafill**

The following table lists datafill for table ALARMTAB.

Field descriptions

Field	Subfield or refinement	Entry	Explanation and action
KEY		alphanumeric (1 to 16 characters)	<p><i>Key</i> Enter data in one of the following formats:</p> <ul style="list-style-type: none"> • <name of OM register>\$<name of tuple> • <name of OM register>\$<number of tuple> • <name of OM register>\$<total>
ENABLED		Y or N	<p><i>Enabled</i> Enter Y (yes) if thresholding of OM is done; otherwise, enter N (no).</p>
ALMLEVEL		CR, MJ, MN, NA	<p><i>Alarm level</i> Enter the type of alarm activated: CR (critical), MJ (major), MN (minor), or NA (no alarm).</p>
THRESHLD		1 to 32767	<p><i>Threshold</i> Enter the number of events that, when exceeded during the specified time interval (scan time), activates an alarm. Indicated values outside this range are invalid.</p> <p>The default value for this field is 1.</p>
SCANTIME		1 to 32767	<p><i>Scan time</i> Enter the time interval, in minutes, to specify when thresholding is done. Indicated values outside this range are invalid.</p> <p>The default value for this field is 1.</p>

Datafill example

The following example shows sample datafill for table ALARMTAB.

ALARMTAB (end)

MAP display example for table ALARMTAB

KEY	ENABLED	ALMLEVEL	THRESHLD	SCANTIME
EXTOVFL,\$49	Y	MJ 1	1	
CCBOVFL,\$0	Y	MJ 1	1	
CPLOOVFL,\$0	Y	MN 1	1	
CPLPOVFL,\$0	Y	CR 1	1	
OUTBOVFL,\$0	Y	MJ 1	1	

ALMSC

Table name

Alarm Scan

Functional description

Table ALMSC identifies the function performed by each of the assigned scan (SC) points in the alarm scan groups.

The table that points into table ALMSC is Alarm Scan Group (ALMSCGRP). See the description of table ALMSCGRP for more information.

The following table lists available scan point functions.

Scan point functions (Sheet 1 of 2)

Scan point	Function
ABMTMFL	Alarm battery failure, miscellaneous trunk module
ABOAUFL	Alarm battery failure, office alarm unit
ABSFAIL	Alarm battery supply failure
ACDLPTST	Alarm control and display lamp test
ALMGRP	Alarm grouping
AUDARM	Audible alarm reset, miscellaneous trunk module
AUDARD	Audible alarm reset, office alarm unit
AUDDIS	Audible alarm disable
CRPREFLR	Critical alarm, preceding floor
CRPWR	Critical power alarm
CRSUCFLR	Critical alarm, succeeding floor
FEEDLOSS1	DMS power feed loss, OAU
FEEDLOSS2	DMS power feed loss, MTM
FSPAIS	Frame supervisory panel aisle XX = A to Z and AA to RR (excluding I, O, II, and OO)
<p>Note: When you assign a scan point for detection of low voltage (LOWBATT1 and LOWBATT2 on the NT3X82 card), you must also assign the LOWVOLTPWR SD function.</p>	

ALMSC (continued)**Scan point functions (Sheet 2 of 2)**

Scan point	Function
LOWBATT1	Low office battery, OAU (See Note)
LOWBATT2	Low office battery, MTM (See Note)
MJPREFLR	Major alarm, preceding floor
MJPWR	Major power alarm
MJSUCFLR	Major alarm, succeeding floor
MNPREFLR0	Major alarm, preceding floor
MNPWR	Minor power alarm
MNSUCFLR	Minor alarm, succeeding floor
PDCFAIL	Power distribution center failure
RDBALM	Remote distribution bay alarm
RDTALRMCO	Remote digital terminal alarm cut-off
REMOTEAR	Remote alarm release
TONEMONITOR	Tone monitor for alarm sending
TSTLN101	101 test line
TTCNTXFR	TTC night alarm transfer
VCEALMO	Recorded announcement 0 (zero)
XFRALM	Alarm transfer
130MONITOR	130-V monitor (See Note)
Note: When you assign a scan point for detection of low voltage (LOWBATT1 and LOWBATT2 on the NT3X82 card), you must also assign the LOWVOLTPWR SD function.	

Scan and signal distribution points work together. SC points detect alarm conditions such as loss of loop closure, ground, or battery feed. SD points report these alarm conditions audibly (bells) or visually (lights).

For each alarm SC point with field LOGIC set to Y (yes), the alarm SD functions are part of the system logic (fixed).

ALMSC (continued)

For each alarm SC point with field LOGIC set to N (no), the operating company can define up to 14 related SD functions.

If Field LOGIC is set to Y to designate a fixed function, the affected SD point generates an audible or visual alarm.

If field LOGIC is set to N to designate a non-fixed function, the operating company must set up the related SD point for the desired type of alarm indication.

Nortel provides a standard set of SD functions for each alarm SC point that has field LOGIC set to Y.

The standard set of SD functions for each alarm SC point can be changed by the operating company to suit their requirements.

The following table lists the available signal distribution point functions.

Signal distribution point functions (Sheet 1 of 3)

Signal distribution point	Function
ABAUD	Alarm battery supply, audible alarm
AB0AU	Alarm battery supply, OAU, visual
ABSVIS	Alarm battery supply, visual
ALMXFR	Alarm transfer
COMAUD1	Common audible, OAU
COMAUD2	Common audible, MTM
CRALMAUD	Critical alarm audible
CRALMVIS	Critical alarm visual
CRPWRVIS	Critical power alarm visual
EXPILDMS	Exit pilot DMS
EXPILPWR	Exit pilot power
Note: When you assign a scan point for detection of low voltage (LOWBATT1 and LOWBATT2 on the NT3X82 card), you must also assign the LOWVOLTPWR SD function. You use scan point 130MONITOR only for non-LPA systems (systems that do not contain the NT3X83BA card). For LPA configurations, use MONITOR.	

ALMSC (continued)**Signal distribution point functions (Sheet 2 of 3)**

Signal distribution point	Function
LN101TST	101 test line
LOWVOLTPWR	Low DMS office battery level
MJALMAUD1 & 2	Major alarm audible (1 OAU, 2 MTM)
MJALMVIS	Major alarm visual
MJOTHVIS	Major alarm, other floor, visual
MJPWRVIS	Major power alarm visual
MJVISLOOP	Major alarm visual loop
MJXFR	Major alarm transfer
MNALMAUD	Minor alarm audible
MNALMVIS	Minor alarm visual
MNOTHVIS	Minor alarm, other floor, visual
MNPWRVIS	Minor power alarm visual
MNVISLOOP	Minor alarm visual loop
MXFR	Minor alarm transfer
MTMFAIL	Miscellaneous trunk module failure
MTMPWR	Miscellaneous trunk module power transfer
NTALMXFR	Night alarm transfer
OAUFAIL	Office alarm unit failure
OAUFLAUD	Office alarm unit failure, audible
OAUFLVIS	Office alarm unit failure, visual
OAPWR	Office alarm unit power transfer
<p>Note: When you assign a scan point for detection of low voltage (LOWBATT1 and LOWBATT2 on the NT3X82 card), you must also assign the LOWVOLTPWR SD function. You use scan point 130MONITOR only for non-LPA systems (systems that do not contain the NT3X83BA card). For LPA configurations, use MONITOR.</p>	

ALMSC (continued)

Signal distribution point functions (Sheet 3 of 3)

Signal distribution point	Function
OAUVISLOOP	Office alarm unit power visual loop
PDCVIS	Power distribution center visual
PREFLRCR	Preceding floor, critical alarm
PREFLRMJ	Preceding floor, major alarm
PREFLRMN	Preceding floor, minor alarm
SUCFLRCR	Succeeding floor, critical alarm
SUCFLRMJ	Succeeding floor, major alarm
SUCFLRMN	Succeeding floor, minor alarm

Note: When you assign a scan point for detection of low voltage (LOWBATT1 and LOWBATT2 on the NT3X82 card), you must also assign the LOWVOLT_PWR SD function. You use scan point 130MONITOR only for non-LPA systems (systems that do not contain the NT3X83BA card). For LPA configurations, use MONITOR.

The following table lists suggested miscellaneous alarm scan point functions for use by the operating company. The operating company supplies input data for the miscellaneous alarm SC points.

Suggested miscellaneous alarm scan point functions (Sheet 1 of 2)

Scan point	Function	Type
FIREALM	Fire alarm	CR
SMOKEALM	Smoke alarm	CR
GASALM	Building gas alarm	CR
FRONTDOR	Front door alarm	MJ
REARDOR	Rear door alarm	MJ
HIGHTEMP	Building high temperature alarm	MJ
LOWTEMP	Building low temperature alarm	MJ
HIGHHUM	Building high humidity alarm	MJ
LOWHUM	Building low humidity alarm	MJ

ALMSC (continued)**Suggested miscellaneous alarm scan point functions (Sheet 2 of 2)**

Scan point	Function	Type
COMACFAL	Commercial AC failure alarm	MJ
AIRDRYER	Air dryer failure alarm	MJ
CABPRESS	Cable pressure low alarm	MJ
SEWPUMP	Sewage pump alarm	MJ
HIWATER	Sump pump high water alarm	MJ
RDBALM	Remote distributor bays	CR
VCEALM1-4	Recorded announcements	MN

Datafill sequence and implications

You must datafill the hardware alarm scan groups in table ALMSCGRP before you datafill table ALMSC. After you enter the scan groups in table ALMSCGRP, you can datafill table ALMSC with the scan group numbers in the ALMSCGRP tuple entries.

For common language location identifier (CLLI) OAUSC in table CLLI, you must datafill field TRKGRSIZ as the number of tuples in table ALMSCGRP.

Note: The trunk group size for fixed pseudo CLLI codes OAUSC and OAUSD is equal to the number of scan and signal distribution groups required for office alarm.

Table size

The maximum size is 4096 tuples. Memory is automatically allocated for 4096 SC points. If you do not datafill all the predefined SC points, the size of table ALMSC decreases

Datafill

The following table lists datafill for table ALMSC. You datafill fields FUNCTION, SCGROUP, POINT, NORMALST, REPORT, ALM, and

ALMSC (continued)

subfield LOGIC only if the entry is the first record for the scan point. If the entry is not the first record for the scan point, you leave these fields blank.

Field descriptions (Sheet 1 of 2)

Field	Subfield or refinement	Entry	Explanation and action
FUNCTION		alphanumeric (vector of up to 16 characters)	<i>Function</i> Enter the alarm scan point. See the first table for a list of alarm scan point functions. See the third table for a list of suggested miscellaneous alarm scan point functions.
SCGROUP		0 to 512	<i>Scan group</i> Enter the scan group to which the scan point belongs.
POINT		0 to 6	<i>Scan point</i> Enter the scan point number within the scan group.
NORMALST		0 to 1	<i>Normal state</i> Enter the normal state of the scan point. If the scan point is normally off or open, enter 0 (zero). If the scan point is normally on or closed, enter 1.
REPORT		Y or N	<i>Report</i> Enter Y (yes) if an alarm report is logged; otherwise, enter N (no).
ALM		CR, MJ, MN, or NA	<i>Alarm</i> Enter the type of alarm to be activated: CR (critical alarm), MJ (major alarm), MN (minor alarm), or NA (no alarm).
LOGIC		see subfields	<i>Logic</i> This field consists of subfield FIX_LOGIC.
	FIX_LOGIC	Y or N	<i>Fix logic</i> Enter Y if the logic associated with the function is fixed. If you enter Y, no other datafill is required. Enter N if the logic associated with the function is not fixed. Then, datafill refinements SDFUNCT, ALMGRP, and ALMXFR.
NON_FIX_LOGIC_VECTOR		see subfields	This field consists of subfields SDFUNCT, ALMGRP, and ALMXFR.

ALMSC (continued)**Field descriptions (Sheet 2 of 2)**

Field	Subfield or refinement	Entry	Explanation and action
	SDFUNCT	alphanumeric	<i>Signal distribution function</i> Enter the signal distribution (SD) function or functions associated with a specific scan point. See the second table for a list of SD point functions.
	ALMGRP	Y or N	<i>Alarm grouping</i> Enter Y if the alarm function is activated when the alarm grouping key is activated. Enter N if the alarm function is activated at all times, regardless of the alarm grouping key setting.
	ALMXFR	Y or N	<i>Alarm transfer</i> Enter Y if the alarm function is activated when the alarm transfer key is activated, otherwise, enter N.

Datafill example

The following example shows sample datafill for table ALMSC.

ALMSC (continued)

MAP display example for table ALMSC

FUNCTION	SCGROUP	POINT	NORMALST	REPORT	ALM	LOGIC
REMOTEAR	2	1	0	Y	NA	Y
XFRALM	2	0	0	Y	NA	Y
TTCNTXFR	2	3	0	Y	NA	Y
AUDARO	0	1	0	Y	NA	Y
CRPWR	4	0	0	Y	CR	N (CRPWRVIS N N) (CRALMAUD N N) (COMAUD1 N N) (COMAUD2 N N) (CRVISLOOP N N) (PREFLRCR N N) (EXPILPWR N N) (MJXFR N N) (SUCFLRCR Y N) \$
MJPWR	4	1	0	Y	MJ	N (MJPWRVIS N N) (MJALMAUD1 N N) (MJALMAUD2 N N) (COMAUD1 N N) (COMAUD2 N N) (MJVISLOOP N N) (PREFLRMJ N N) (EXPILPWR N N) (MJXFR N Y) (SUCFLRMJ Y N) \$
MNPWR	4	2	0	Y	MN	N (MNPWRVIS N N) (MNALMAUD N N) (COMAUD1 N N) (COMAUD2 N N) (MNVISLOOP N N) (PREFLRMN N N) (EXPILPWR N N) (MJXFR N Y) (SUCFLRMN Y N) \$

ALMSC (continued)**MAP display example for table ALMSC (continued)**

FUNCTION	SCGROUP	POINT	NORMALST	REPORT	ALM	LOGIC
ACDLPTST	4	5	0	Y	NA	Y
TSTLN101	2	4	0	Y	MN	Y
PDCFFAIL	4	3	0	Y	MJ	N (PDCVIS N N) (MJALMAUD1 N N) (MJALMAUD2 N N) (COMAUD1 N N) (COMAUD2 N N) (EXPILDMS N N) (PREFLRMJ N N) (MJVISLOOP N N) (MJXFR N Y) (SUCFLRMJ Y N) \$
ABSFAIL	4	4	0	Y	MN	N (ABAUD N N) (ABPDC N N) (COMAUD1 N N) (COMAUD2 N N) (EXPILDMS N N) (PREFLRMN N N) (OAUVISLOOP N N) (MNXFR N Y) (SUCFLRMN Y N) \$
FSPAISA	5	0	0	Y	MJ	N (MJALMVIS N N) (MJALMAUD1 N N) (MJALMAUD2 N N) (COMAUD1 N N) (COMAUD2 N N) (MJVISLOOP N N) (PREFLRMJ N N) (EXPILDMS N N) (MJXFR N Y) (SUCFLRMJ Y N) \$

ALMSC (continued)

MAP display example for table ALMSC (continued)

FUNCTION	SCGROUP	POINT	NORMALST	REPORT	ALM	LOGIC
FSPAISB	5	1	0	Y	MJ	N (MJALMVIS N N) (MJALMAUD1 N N) (MJALMAUD2 N N) (COMAUD1 N N) (COMAUD2 N N) (MJVISLOOP N N) (PREFLRMJ N N) (EXPILDMS N N) (MJXFR N Y) (SUCFLRMJ Y N) \$
FSFSPAISC	5	2	0	Y	MJ	N (MJALMVIS N N) (MJALMAUD1 N N) (MJALMAUD2 N N) (COMAUD1 N N) (COMAUD2 N N) (MJVISLOOP N N) (PREFLRMJ N N) (EXPILDMS N N) (MJXFR N Y) (SUCFLRMJ Y N) \$
FSPAISD	5	3	0	Y	MJ	N (MJALMVIS N N) (MJALMAUD1 N N) (MJALMAUD2 N N) (COMAUD1 N N) (COMAUD2 N N) (MJVISLOOP N N) (PREFLRMJ N N) (EXPILDMS N N) (MJXFR N Y) (SUCFLRMJ Y N) \$

ALMSC (continued)**MAP display example for table ALMSC (continued)**

FUNCTION	SCGROUP	POINT	NORMALST	REPORT	ALM	LOGIC
FSPAISE	5	4	0	Y	MJ	N (MJALMVIS N N) (MJALMAUD1 N N) (MJALMAUD2 N N) (COMAUD1 N N) (COMAUD2 N N) (MJVISLOOP N N) (PREFLRMJ N N) (EXPILDMS N N) (MJXFR N Y) (SUCFLRMJ Y N) \$
FSPAISF	5	5	0	Y	MJ	N (MJALMVIS N N) (MJALMAUD1 N N) (MJALMAUD2 N N) (COMAUD1 N N) (COMAUD2 N N) (MJVISLOOP N N) (PREFLRMJ N N) (EXPILDMS N N) (MJXFR N Y) (SUCFLRMJ Y N) \$
AUDDIS	5	6	0	Y	MN	N (MNALMVIS N N) \$
OMONITOR	2	2	0	Y	MJ	N (MJALMVIS N N) \$
LOWBATT1	0	2	0	Y	MJ	N (LOWVOLTPWR N N) (MJPWRVIS N N) (MJALMAUD1 N N) (MJALMAUD2 N N) (COMAUD1 N N) (COMAUD2 N N) (MJVISLOOP N N) (PREFLRMJ N N) (EXPILPWR N N) (MJXFR N N) (SUCFLRMJ N N) \$

ALMSC (end)

MAP display example for table ALMSC (continued)

FUNCTION	SCGROUP	POINT	NORMALST	REPORT	ALM	LOGIC
LOWBATT2	1	2	0	Y	MJ	N (LOWVOLTPWR N N) (MJPWRVIS N N) (MJALMAUD1 N N) (MJALMAUD2 N N) (COMAUD1 N N) (COMAUD2 N N) (MJVISLOOP N N) (PREFLRMJ N N) (EXPILPWR N N) (MJXFR N N) (SUCFLRCR N N) \$
FEEDLOSS1	0	4	0	Y	CR	N (CRPWRVIS N N) (CRALMAUD N N) (COMAUD1 N N) (COMAUD2 N N) (CRVISLOOP N N) (PREFLRCR N N) (EXPILPWR N N) (MJXFR N N) (SUCFLRCR N N)
FEEDLOSS2	1	4	0	Y	CR	N (CRPWRVIS N N) (CRALMAUD N N) (COMAUD1 N N) (COMAUD2 N N) (CRVISLOOP N N) (PREFLRCR N N) (EXPILPWR N N) (MJXFR N N) (SUCFLRCR N N) \$

Table history

BASE11

Changes associated with the Low Power Alarm (LPA) system

BCS36

The following changes were made to table ALMSC:

- changed LOWVOLT PWR to LOWVOLTPWR
- added new tuples to datafill example

ALMSCGRP

Table name

Alarm Scan Group

Overview

The following office alarm systems (OAS) exist:

- Version 1
- Version 2
- Version 2 Enhanced Alarm System (EAS)
- Low Power Alarm (LPA) system

The DMS alarm systems detect and report failures and service degradations. The alarm system is a set of hardware devices and software modules that provide the following:

- visual (lights) and audible (tones) indication of alarm conditions
- transfer of critical, major, and minor alarms to remote sites
- data loops for a portable MAP terminal
- battery power feed for telephone headset communication within the office with the following:
 - frame supervisory panel (FSP)
 - maintenance supervisory panel (MSP)
 - main distribution frame (MDF)
 - operator MAP terminal access points

The alarm system uses scan (SC) points and signal distribution (SD) points to monitor and report the alarm status of each equipment row, to a maximum of 40 rows. Scan points detect voltage, ground, open-loop, or closed-loop conditions. Signal distribution points transfer alarm indications to alarm panels and other equipment. Hardware switch settings and datafill in tables ALMSCGRP, ALMSC, ALMSDGRP, and ALMSD define the scan and signal distribution points.

Some hardware is specific to one alarm system version. Other hardware, like scan and signal distribution cards, is common to all versions.

The office alarm unit (OAU) in Version 1 OAS is on a maintenance trunk module (MTM) shelf. All alarm detection and control hardware is in the OAU and an associated (standby) MTM. The Version 1 OAU uses NT2X41, NT2X42, and NT2X43 cards.

ALMSCGRP (continued)

The OAU is dedicated to the alarm system. The standby MTM contains the alarm system backup circuits that generate an alarm if the OAU fails. The standby MTM can also contain equipment not related to the alarm system.

In the Version 2 OAS and the EAS, the primary OAU and the standby unit are on an MTM or ISM shelf.

In the LPA system, the primary OAU and the standby unit are on an ISM shelf.

In Version 2 and later OAS, you can provision the alarm SC and SD hardware on various MTM or ISM shelves throughout the office.

For further information on the OAS, refer to *Alarm System Description*, 297-1001-122.

NT3X82 - OAU dead system card

The OAU dead system (NT3X82) cards used in Version 2, EAS, and LPA OAUs contain both SC and SD points. These cards contain two circuits. The even-numbered circuit contains SD points and the odd-numbered circuit contains SC points. The following table shows the versions of NT3X82 card.

NT3X82 versions

PEC	Card name	Shelf	OAS
NT3X82AA	OAU dead system with unique audibles	MTM	Version 2
NT3X82AB	OAU dead system with common audibles	MTM	Version 2
NT3X82AC	OAU dead system with unique audibles	MTM	EAS
NT3X82AD	OAU dead system with common audibles	MTM	EAS
NT3X82AE	OAU dead system with unique audibles (-60V version)	MTM	EAS
NT3X82AF	OAU dead system with unique audibles	ISM	Version 2
NT3X82AG	OAU dead system with common audibles	ISM	Version 2
NT3X82AH	OAU dead system with unique audibles	ISM	EAS
NT3X82AJ	OAU dead system with common audibles	ISM	EAS
NT3X82AK	OAU dead system with unique audibles (-60V version)	ISM	EAS
NT3X82BA	LPA dead system audibles & IATC	ISM	LPA

ALMSCGRP (continued)

In the LPA system, the OAU common audibles, unique audibles, and the inactive timing circuit (IATC) clock are combined on the NT3X82BA card.

The following table lists the SD and SC points for NT3X82AA, NT3X82AC, NT3X82AE, NT3X82AF, NT3X82AH, or NT3X82BA cards in an OAU.

SD and SC points for NT3X82AA, NT3X82AC, NT3X82AE, NT3X82AF, NT3X82AH, or NT3X82BA in OAU

SD point	Function	Normal state	SC point	Function	Normal state
0	OAUFAIL	0	0	ABMTMFL	0
1	OAUPWR	0	1	AUDARO	0
2	MJALMAUD1	0	2	LOWBATT1	0
3	ABAUD	0	3	Internal circuit	0
4	ABOAU	0	4	FEEDLOSS1	0
5	COMAUD	0	5	Internal circuit	0
6	Internal circuit	0	6	Internal circuit	0
7	Internal circuit	0	7	Internal circuit	0

The following table lists the SD and SC points for the NT3X82AA, NT3X82AC, NT3X82AE, NT3X82AF, NT3X82AH, or NT3X82BA cards in a standby MTM or ISM.

SD and SC points for NT3X82AA, NT3X82AC, NT3X82AE, NT3X82AF, NT3X82AH, or NT3X82BA in standby MTM or ISM (Sheet 1 of 2)

SD point	Function	Normal state	SC point	Function	Normal state
0	MTMFAIL	0	0	ABOAUFL	0
1	MTMPWR	0	1	AUDARM	0
2	MJALMAUD2	0	2	LOWBATT2	0
3	OAUFLAUD	0	3	Internal circuit	0
4	OAUFLVIS	0	4	FEEDLOSS2	0
5	COMAUD	0	5	Internal circuit	0

ALMSCGRP (continued)

SD and SC points for NT3X82AA, NT3X82AC, NT3X82AE, NT3X82AF, NT3X82AH, or NT3X82BA in standby MTM or ISM (Sheet 2 of 2)

SD point	Function	Normal state	SC point	Function	Normal state
6	Internal circuit	0	6	Internal circuit	0
7	Internal circuit	0	7	Internal circuit	0

The following table lists the SD and SC points for NT3X82AB, NT3X82AD, NT3X82AG, or NT3X82AJ cards in an OAU.

SD and SC points for NT3X82AB, NT3X82AD, NT3X82AG, or NT3X82AJ in OAU

SD point	Function	Normal state	SC point	Function	Normal state
0	OAUFAIL	0	0	ABMTMFL	0
1	OAUPWR	0	1	AUDARO	0
2	Internal circuit	0	2	LOWBATT1	0
3	Internal circuit	0	3	Internal circuit	0
4	OAUFLVIS	0	4	FEEDLOSS1	0
5	COMAUD1	0	5	Internal circuit	0
6	Internal circuit	0	6	Internal circuit	0

The following table lists the SD and SC points for NT3X82AB, NT3X82AD, NT3X82AG, or NT3X82AJ cards in a standby MTM or ISM.

SD and SC points for NT3X82AB, NT3X82AD, NT3X82AG, or NT3X82AJ in standby MTM or ISM (Sheet 1 of 2)

SD point	Function	Normal state	SC point	Function	Normal state
0	MTMFAIL	0	0	ABOAUFL	0
1	MTMPWR	0	1	AUDARM	0
2	Internal circuit	0	2	LOWBATT2	0
3	Internal circuit	0	3	Internal circuit	0
4	OAUFLVIS	0	4	FEEDLOSS2	0

ALMSCGRP (continued)

SD and SC points for NT3X82AB, NT3X82AD, NT3X82AG, or NT3X82AJ in standby MTM or ISM (Sheet 2 of 2)

SD point	Function	Normal state	SC point	Function	Normal state
5	COMAUD2	0	5	Internal circuit	0
6	Internal circuit	0	6	Internal circuit	0

NT3X83 - OAU alarm transfer card

The OAU alarm transfer (NT3X83) cards in Version 2, EAS, and LPA OAU's contain SC and SD points. These cards contain two circuits. The even-numbered circuit contains SD points and the odd-numbered circuit contains SC points. The following table shows the versions of NT3X83 card.

NT3X83 versions

PEC	Card name	Shelf	OAS
NT3X83AA	OAU alarm transfer	MTM	Version 2, EAS
NT3X83AB	OAU alarm transfer (-60V version)	MTM	Version 2, EAS
NT3X83AC	OAU alarm transfer	ISM	Version 2, EAS
NT3X83AD	OAU alarm transfer (-60V version)	ISM	Version 2, EAS
NT3X83BA	LP alarm transfer & sending	ISM	LPA

In the LPA system, the OAU alarm sending function is on the NT3X83BA card. This function is on the NT3X84 card in alarm systems other than LPA. The NT3X83BA can be used in both -48V and -60V applications.

ALMSCGRP (continued)

The following table lists the SD and SC points for the NT3X83 card.

SD and SC points for NT3X83

SD point	Function	Normal state	SC point	Function	Normal state
0	ALMXFR	0	0	AXFRALM	0
1	MJXFR	0	1	REMOPEAR	0
2	MNXFR	0	2	130MONITOR (See Note)	0
3	LN101TST	0	3	TTCNTXFR	0
4	NTALMXFR	0	4	TSTLN101	0
5	EXPILDMS	0	5	Internal circuit	0
6	EXPILPWR	0	6	Internal circuit	0

Note: You use scan point 130MONITOR only for non-LPA systems (systems that do not contain the NT3X83BA card). For LPA configurations, use MONITOR.

NT3X84 - OAU alarm sending card

The OAU alarm sending (NT3X84) cards in Version 2 and EAS OAU's contain both SC and SD points. These cards contain two circuits. The even-numbered circuit contains SD points and the odd-numbered circuit contains SC points. The following table lists the versions of NT3X84 card.

NT3X84 versions

PEC	Card name	Shelf	OAS
NT3X84AA	OAU alarm sending	MTM	Version 2, EAS
NT3X84AB	OAU alarm sending	ISM	Version 2, EAS

In the LPA system, the OAU alarm sending and alarm transfer functions are combined on the NT3X83BA card.

ALMSCGRP (continued)

The following table lists SD and SC points for the NT3X84 card.

SD and SC points for NT3X84

SD point	Function	Normal state	SC point	Function	Normal state
0	Internal circuit	0	0	Internal circuit	0
1	Internal circuit	0	1	Internal circuit	0
2	Internal circuit	0	2	TONEMONITOR	0
3	LN101TST	0	3	TTCNTXFR	0
4	NTALMXFR	0	4	TSTLN101	0
5	EXPILDMS	0	5	Internal circuit	0
6	EXPILPWR	0	6	Internal circuit	0
7	Internal circuit	0	7	Internal circuit	0

NT3X85 - OAU alarm group card

The OAU alarm group (NT3X85) cards in Version 2, EAS, and LPA OAU contain both SC and SD points. These cards contain two circuits. The even-numbered circuit contains SD points and the odd-numbered circuit contains SC points. The following table shows the versions of NT3X85 card.

NT3X85 versions

PEC	Card name	Shelf	OAS
NT3X85AA	OAU alarm group	MTM	Version 2, EAS, LPA
NT3X85AB	OAU alarm group	ISM	Version 2, EAS, LPA

The following table lists the SD and SC points for the NT3X85 card.

SD and SC points for NT3X85 (Sheet 1 of 2)

SD point	Function	Normal state	SC point	Function	Normal state
0	MJOTHVIS	0	0	CRSUCFLR	0
1	MNOTHVIS	0	2	MJSUCFLR	0

ALMSCGRP (continued)**SD and SC points for NT3X85 (Sheet 2 of 2)**

SD point	Function	Normal state	SC point	Function	Normal state
2	SUCFLRCR	0	2	MNSUCFLR	0
3	SUCFLRMJ	0	3	CRPREFLR	0
4	SUCFLRMN	0	4	MJPREFLR	0
5	PREFLRCR	0	5	MNPREFLR	0
6	PREFLRMJ	0	6	ALMGRP	0
7	PREFLRMN	0	7	Internal circuit	0

NT0X10AA - miscellaneous scan card

Each miscellaneous scan detector card provides 14 single-lead scan points. The card has two groups of seven scan points (0 to 6). You assign a trunk module circuit number to each scan group.

The first miscellaneous scan card has the following SC point assignments.

Scan points for first NT0X10 card

Even-numbered circuit			Odd-numbered circuit		
SC point	Function	Normal state	SC point	Function	Normal state
0	CRPWR	0	0	FSPAISA	0
1	MJPWR	0	1	FSPAISB	0
2	MNPWR	0	2	FSPAISC	0
3	PDCFAIL	0	3	FSPAISD	0
4	ABSFAIL	0	4	FSPAISE	0
5	ACDLPTST	0	5	FSPAISF	0
6	VCEALM0	0	6	AUDDIS	0

ALMSCGRP (continued)

The second miscellaneous scan card has the following SC point assignments.

Scan points for second NT0X10 card

Even-numbered circuit	Odd-numbered circuit				
SC point	Function	Normal state	SC point	Function	Normal state
0	FSPAISG	0	0	Spare	0
1	PSPAISH	0	1	Spare	0
2	PSPAISJ	0	2	Spare	0
3	FSPAISK	0	3	Spare	0
4	FSPAISL	0	4	Spare	0
5	PSPAISM	0	5	Spare	0
6	RDBALM	0	6	Spare	0

The operating company can assign the spare SC points to various unique applications.

The third miscellaneous scan card has the following SC point assignments.

Scan points for third NT0X10 card

Even-numbered circuit	Odd-numbered circuit				
SC point	Function	Normal state	SC point	Function	Normal state
0	FSPAISN	0	0	FSPAISV	0
1	PSPAISP	0	1	FSPAISW	0
2	PSPAISQ	0	2	FSPAISX	0
3	FSPAISR	0	3	FSPAISY	0
4	FSPAISS	0	4	FSPAISZ	0
5	FSPAIST	0	5	FSPAISAA	0
6	RDBALU	0	6	FSPAISBB	0

ALMSCGRP (continued)

The fourth miscellaneous scan card has the following SC point assignments.

Scan points for fourth NT0X10 card

Even-numbered circuit	Odd-numbered circuit				
SC point	Function	Normal state	SC point	Function	Normal state
0	FSPAISCC	0	0	FSPAISKK	0
1	PSPAISDD	0	1	FSPAISLL	0
2	PSPAISEE	0	2	FSPAISMM	0
3	FSPAISFF	0	3	FSPAISNN	0
4	FSPAISGG	0	4	FSPAISPP	0
5	FSPAISHH	0	5	FSPAISQQ	0
6	FPAISJJ	0	6	FSPAISRR	0

The fifth miscellaneous scan card contains 14 customer-assignable scan points.

The sixth miscellaneous scan card contains 14 customer-assignable scan points.

Functional description

Table ALMSCGRP stores alarm circuit equipment, location, and card type information. This table is a head table for table ALMSC.

Table ALMSCGRP has a fixed pseudo common language location identifier (CLLI) code of OAUSC. For information on the fixed CLLI code, see the description of table CLLI.

Datafill sequence and implications

Before you assign a scan group to table ALMSCGRP, verify that the scan group has not been assigned to table SCGRP for other switching units, or to tables NWMSC and NWMSCPT.

Table size

0 to 512 tuples

ALMSCGRP (continued)

The true datafillable maximum for table ALMSCGRP is 492 tuples. The maximum size of table ALMSCGRP is 512 tuples, but 20 of these tuples are reserved for table SFWALARM. These 20 tuples do not appear in table ALMSCGRP.

The maximum number of scan points you can assign is 4096. The maximum number of scan groups you can datafill is 512.

Memory for SC groups is automatically allocated.

Datafill

The following table lists datafill for table ALMSCGRP.

Field descriptions (Sheet 1 of 2)

Field	Subfield or refinement	Entry	Explanation and action
SCGROUP		0 to 512	<i>Scan group</i> Enter the scan group number.
TMTYPE		ATM, CTM, DTM, ISM, MTM, OAU, PTM, RMM, RSM, STM, TAN, TMA, TM2, TM4, TM8, or T8A	<i>Trunk module type</i> Enter the type of trunk module that contains the circuit. Note: Peripheral trunk modules (PTMs) are manufacture discontinued. PTMs that are datafilled as PTMs in table TMINV cause the failure of international 101 test lines. You must datafill PTMs as MTMs to avoid this problem.
TMNO		0 to 2047	<i>Trunk module number</i> Enter the number of the trunk module that contains the circuit. If the entry in field TMTYPE is OAU, enter 0. If the entry in field TMTYPE is MTM, enter 0 to 255. If the entry in field TMTYPE is RSM, enter 99.

ALMSCGRP (continued)

Field descriptions (Sheet 2 of 2)

Field	Subfield or refinement	Entry	Explanation and action
TMCKTNO		0 to 29	<i>Trunk module circuit number</i> Enter the trunk module circuit number for the card.
CARDCODE		0X10AA 3X82AA 3X82AB 3X82AC 3X82AD 3X82AE 3X82AF 3X82AG 3X82AH 3X82AJ 3X82AK 3X82BA 3X83AA 3X83AB 3X83AC 3X83AD 3X83BA 3X84AA 3X84AB 3X85AA or 3X85AB	<i>Product engineering code</i> Enter the code (abbreviated PEC) for the alarm card. For Version 2 OAU on an MTM shelf, enter 3X82AA or 3X82AB. For EAS OAU on an MTM shelf, enter 3X82AC, 3X82AD, or 3X82AE. For Version 2 OAU on an ISM shelf, enter 3X82AF or 3X82AG. For EAS OAU on an ISM shelf, enter 3X82AH, 3X82AJ, or 3X82AK. For LPA OAU, enter 3X82BA.

Datafill example

The following example shows sample datafill for table ALMSCGRP.

MAP display example for table ALMSCGRP

SCGROUP	TMTYPE	TMNO	TMCKTNO	CARDCODE	
	0	MTM	0	1	3X82AA
	1	MTM	1	1	3X82AA
	2	MTM	0	11	3X83AA
	3	MTM	0	13	3X84AA
	4	MTM	0	4	0X10AA
	5	MTM	0	5	0X10AA

Table history

BASE11

Added information on the Low Power Alarm (LPA) system

BCS36

Added values 3X82AC and 3X82AD to the valid entries for field
CARDCODE

ALMSD

Table name

Alarm Signal Distributor Point

Functional description

Table ALMSD identifies the function performed by each of the assigned signal distribution (SD) points in the alarm SD groups.

The table that points into table ALMSD is Alarm Signal Distributor Group (ALMSDGRP). See the description of table ALMSDGRP for more information.

The following table lists available signal distribution point functions.

Signal distribution point functions (Sheet 1 of 4)

Signal distribution point	Function
ABAUD	Alarm battery supply, audible alarm
ABOAU	Alarm battery supply, office alarm unit (OAU), visual
ABSVIS	Alarm battery supply, visual
ALMXFR	Alarm transfer
COMAUD1	Common audible, OAU
COMAUD2	Common audible, maintenance trunk module (MTM)
CRALMAUD	Critical alarm audible
CRALMVIS	Critical alarm visual
CRPWRVIS	Critical power alarm visual
EXPILDMS	Exit pilot DMS
EXPILPWR	Exit pilot power
LN101TST	101 test line
MJALMAUD1&2	Major alarm audible (1-OAU, 2-MTM)
<p>Note: When you assign a scan point for detection of low voltage (LOWBATT1 and LOWBATT2 on the NT3X82 card), you must also assign the LOWVOLTPWR SD function.</p>	

ALMSD (continued)**Signal distribution point functions (Sheet 2 of 4)**

Signal distribution point	Function
MJALMVIS	Major alarm visual
MJOTHVIS	Major alarm, other floor, visual
MJPWRVIS	Major power alarm visual
MJVISLOOP	Major alarm visual loop
MJXFR	Major alarm transfer
MNALMAUD	Minor alarm audible
MNALMVIS	Minor alarm visual
MNOTHVIS	Minor alarm, other floor, visual
MNPWRVIS	Minor power alarm visual
MNVISLOOP	Minor alarm visual loop
MNFXR	Minor alarm transfer
LOWVOLTPWR	Low DMS office battery level
MTMFAIL	Miscellaneous trunk module failure
MTMPWR	Miscellaneous trunk module power transfer
NTALMXFR	Night alarm transfer
OAUFAIL	Office alarm unit failure
OAUFLAUD	Office alarm unit failure, audible
OAUFLVIS	Office alarm unit failure, visual
OAUVISLOOP	Office alarm unit power visual loop
PDCVIS	Power distribution center visual
PREFLRCR	Preceding floor, critical alarm
PREFLRMJ	Preceding floor, major alarm
PREFLRMN	Preceding floor, minor alarm

Note: When you assign a scan point for detection of low voltage (LOWBATT1 and LOWBATT2 on the NT3X82 card), you must also assign the LOWVOLTPWR SD function.

ALMSD (continued)**Signal distribution point functions (Sheet 3 of 4)**

Signal distribution point	Function
RDTACO	Indicates the presence of cut-off RDT alarms
RDTSD1	Remote digital terminal 1
RDTSD2	Remote digital terminal 2
RDTSD3	Remote digital terminal 3
RDTSD4	Remote digital terminal 4
RDTSD5	Remote digital terminal 5
RDTSD6	Remote digital terminal 6
RDTSD7	Remote digital terminal 7
RDTSD8	Remote digital terminal 8
RDTCRIT	Remote digital terminal critical alarm
RDTMAJOR	Remote digital terminal major alarm
RDTMINOR	Remote digital terminal minor alarm
RDTWARN	Indicates the presence of RDT warning-level alarms
SUCFLRCR	Succeeding floor, critical alarm
SUCFLRMJ	Succeeding floor, major alarm
SUCFLRMN	Succeeding floor, minor alarm
SDOC3CUTOFF	Breaks the link between the dead system alarm (DSA) and dynamic overload control (DOC) level 3 to prevent routing controls from being implemented when a simulation of DSA is done
TOPS_ECP_TAPEDEV	Traffic Operator Position System (TOPS) emergency calling present recorded on tape recorder
TOPS_ECW_AUDIBLE	TOPS emergency calling visible
SCC_CC_ALM	Central control alarm
Note: When you assign a scan point for detection of low voltage (LOWBATT1 and LOWBATT2 on the NT3X82 card), you must also assign the LOWVOLTPOWER SD function.	

ALMSD (continued)**Signal distribution point functions (Sheet 4 of 4)**

Signal distribution point	Function
SCC_CCS_ALM	Common channel signaling alarm
SCC_CMC_ALM	Central message controller alarm
SCC_IO_ALM	Input/output controller
SCC_NMC_ALM	Switching network alarm
SCC_CKT_ALM	Circuit limit alarm
SCC_PM_ALM	Peripheral module alarm

Note: When you assign a scan point for detection of low voltage (LOWBATT1 and LOWBATT2 on the NT3X82 card), you must also assign the LOWVOLTPWR SD function.

You use the RDT function entries RDTCRIT, RDTMAJOR, RDTMINOR, and RDTWARN to indicate the severity of the alarm. You use RDTACO to indicate the presence of cut-off RDT alarms.

Note: SD points RDTACO and RDTWARN are optional. You do not need to datafill these SD points before you datafill SD points in table RDTINV.

Datafill sequence and implications

You must datafill table ALMSDGRP before table ALMSD.

You must datafill field SDGROUP in table ALMSDGRP before you datafill SD points.

Table size

The maximum size is 4096 tuples. Memory is automatically allocated for 4096 SD points. If you do not datafill all the predefined SD points, the size of table ALMSD decreases.

ALMSD (continued)**Datafill**

The following table lists datafill for table ALMSD.

Field descriptions

Field	Subfield or refinement	Entry	Explanation and action
FUNCTION		alphanumeric (vector of up to 16 characters)	<i>Function</i> Enter the alarm function. See the first table for a list of signal distribution points.
SDGROUP		0 to 512	<i>Signal distribution group</i> Enter the signal distribution group to which the SD point belongs.
POINT		0 to 7	<i>Signal distribution point</i> Enter the signal distribution point number within the SD group.
NORMALST		0 to 1	<i>Normal state</i> Enter the normal state of the SD point. Enter 0 (zero) if the SD point is normally off or open. Enter 1 if the SD point is normally on or closed.
AUDIBLE		Y or N	<i>Audible</i> Enter Y (yes) if the SD point resets when you operate the audible alarm reset key; otherwise, enter N (no). Note: This field must always contain N for the SD points associated with RDT alarms. Table control software disallows a Y entry.
LAMPTEST		Y or N	<i>Lamp test</i> Enter Y if the SD point is included in the lamp test; otherwise, enter N.

Datafill example

The following example applies to the Office Alarm System Version 1. The example shows the SD assignments for the alarm SD point record you require in all switching units.

ALMSD (continued)**MAP display example for table ALMSD**

FUNCTION	SDGROUP	POINT	NORMALST	AUDIBLE	LAMPTEST
EXPILPWR	0	1	0	N	N
SUCFLRMJ	0	2	0	N	N
SUCFLRPF	0	3	0	N	N
PREFLRNM	0	4	0	N	N
PREFLRMJ	0	5	0	N	N
PREFLRPF	0	6	0	N	N
EXPILDMS	1	0	0	N	N
NTALMXFR	1	1	0	N	N
LN101TST	1	2	0	N	N
ALMXFR	1	3	0	N	N
MJXFR	1	4	0	N	N
MNXFR	1	5	0	N	N
SCC_CCS_ALM	2	0	0	N	N
OAUFail	2	2	0	Y	N
MJALMAUD	2	3	0	Y	N
MNALMAUD	2	4	0	Y	N
ABAUD	2	5	0	Y	N
TRKGPALM	2	6	0	N	N
CRPWRVIS	4	0	0	N	Y
MJPWRVIS	4	1	0	N	Y
MNPWRVIS	4	2	0	N	Y
CRALMVIS	4	3	0	N	Y
MJALMVIS	4	4	0	N	Y
MNALMVIS	4	5	0	N	Y
PDCVIS	4	6	0	N	Y
MJOTHVIS	5	0	0	N	Y
MNOTHVIS	5	1	0	N	Y
ABOAU	5	2	0	N	Y
ABPDC	5	3	0	N	N
MTMFAIL	6	0	1	N	N
MTMPWR	6	1	0	N	N
OAUFLAUD	6	2	0	Y	N
OAUFLVIS	6	3	0	N	N

The following two examples apply to Office Alarm System Version 2.

The first example shows datafill for a small office.

ALMSD (continued)

MAP display example for table ALMSD

FUNCTION	SDGROUP	POINT	NORMALST	AUDIBLE	LAMPTEST
OAUFail	0	0	1	N	N
OAUPWR	0	1	1	N	N
ABOAU	0	4	0	Y	Y
COMAUD1	0	5	0	N	N
MTMFAIL	1	0	1	N	N
MTMPWR	1	1	0	N	N
OAUFLVIS	1	4	0	Y	N
COMAUD2	1	5	0	N	N
LN101TST	2	3	0	N	N
NTALMXFR	2	4	0	N	N
EXPILDMS	2	5	0	N	N
EXPILPWR	2	6	0	N	N
CRALMVIS	3	0	0	Y	Y
MJALMVIS	3	1	0	Y	Y
MNALMVIS	3	2	0	Y	Y
PDCVIS	3	3	0	Y	Y
ABSVIS	3	4	0	N	N
CRPWRVIS	4	0	0	N	Y
MJPWRVIS	4	1	0	N	Y
MNPWRVIS	4	2	0	N	Y
CRVISLOOP	4	3	0	N	N
MJVISLOOP	4	4	0	N	N
MNVISLOOP	4	5	0	N	N
OAUVISLOOP	4	6	0	N	N

The second example shows datafill for a large office.

ALMSD (continued)**MAP display example for table ALMSD**

FUNCTION	SDGROUP	POINT	NORMALST	AUDIBLE	LAMPTEST
OAUFail	0	0	1	N	N
OAUPWR	0	1	1	N	N
MJALMAUD1	0	2	0	Y	N
ABAUD	0	3	0	Y	Y
ABOAU	0	4	0	N	N
COMAUD1	0	5	0	Y	N
MTMFAIL	1	0	1	N	N
MTMPWR	1	1	0	N	N
MJALMAUD2	1	2	0	Y	N
OAUFLAUD	1	3	0	Y	N
OAUFLVIS	1	4	0	N	N
COMAUD2	1	5	0	Y	N
ALMXFR	2	0	0	N	N
MJXFR	2	1	0	N	N
MNXFR	2	2	0	N	N
LN101TST	2	3	0	N	N
NTALMXFR	2	4	0	N	N
EXPILDMS	2	5	0	N	N
EXPILPWR	2	6	0	N	N
MJOTHVIS	3	0	0	N	Y
MNOHVIS	3	1	0	N	Y
SUCFLRCR	3	2	0	N	N
SUCFLRMJ	3	3	0	N	N
SUCFLRMN	3	4	0	N	N
PREFLRCR	3	5	0	N	N
PREFLRMJ	3	6	0	N	N
PREFLRMN	3	7	0	N	N
CRALMVIS	4	0	0	N	Y
MJALMVIS	4	1	0	N	Y
MNALMVIS	4	2	0	N	Y
PDCVIS	4	3	0	N	Y
ABSVIS	4	4	0	N	Y
CRALMAUD	4	5	0	Y	N
MNALMAUD	4	6	0	Y	N
CRPWRVIS	5	0	0	N	Y
MJPWRVIS	5	1	0	N	Y
MNPWRVIS	5	2	0	N	Y
CRVISLOOP	5	3	0	N	N
MJVISLOOP	5	4	0	N	N
MNVISLOOP	5	5	0	N	N
OAUVISLOOP	5	6	0	N	N
SDOC3CUTOFF	6	0	0	N	N

ALMSD (end)

The following example shows possible datafill for RDT SD points.

MAP display example for table ALMSD

FUNCTION	SDGROUP	POINT	NORMALST	AUDIBLE	LAMPTEST
RDTSD1	4	1	0	N	Y
RDTSD2	4	2	0	N	Y
RDTSD8	4	3	0	N	Y

Table history

BASE11

Changes associated with the Low Power Alarm (LPA) system

ALMSDGRP

Table name

Alarm Signal Distributor Group

Overview

The following office alarm systems (OAS) exist:

- Version 1
- Version 2
- Version 2 Enhanced Alarm System (EAS)
- Low Power Alarm (LPA) system

The DMS alarm systems detect and report failures and service degradations. The alarm system is a set of hardware devices and software modules that provide the following:

- visual (lights) and audible (tones) indication of alarm conditions
- transfer of critical, major, and minor alarms to remote sites
- data loops for a portable MAP terminal
- battery power feed for telephone headset communication within the office with the following:
 - frame supervisory panel (FSP)
 - maintenance supervisory panel (MSP)
 - main distribution frame (MDF)
 - operator MAP terminal access points

The alarm system uses scan (SC) points and signal distribution (SD) points to monitor and report the alarm status of each equipment row, to a maximum of 40 rows. Scan points detect voltage, ground, closed-loop, or open-loop conditions. Signal distribution points transfer alarm indications to alarm panels and other equipment. Hardware switch settings and datafill in tables ALMSCGRP, ALMSC, ALMSDGRP, and ALMSD define the scan and signal distribution points.

Some hardware is specific to one alarm system version. Other hardware, like scan and signal distribution cards, is common to all versions.

The office alarm unit (OAU) in Version 1 OAS is on a maintenance trunk module (MTM) shelf. All alarm detection and control hardware is in the OAU and an associated (standby) MTM. The Version 1 OAU uses NT2X41, NT2X42, and NT2X43 cards.

ALMSDGRP (continued)

The OAU is dedicated to the alarm system. The standby MTM contains the alarm system backup circuits that generate an alarm if the OAU fails. The standby MTM can also contain equipment not related to the alarm system.

In the Version 2 OAS and the EAS, the primary OAU and the standby unit are on an MTM or ISM shelf.

In the LPA system, the primary OAU and the standby unit are on an ISM shelf.

In Version 2 and later OAS, you can provision the alarm SC and SD hardware on various MTM or ISM shelves throughout the office.

For further information on the OAS, refer to *Alarm System Description*, 297-1001-122.

NT3X82 - OAU dead system card

The OAU dead system (NT3X82) cards used in Version 2, EAS, and LPA OAUs contain both SC and SD points. These cards contain two circuits. The even-numbered circuit contains SD points and the odd-numbered circuit contains SC points. The following table shows the versions of NT3X82 card.

NT3X82 versions

PEC	Card name	Shelf	OAS
NT3X82AA	OAU dead system with unique audibles	MTM	Version 2
NT3X82AB	OAU dead system with common audibles	MTM	Version 2
NT3X82AC	OAU dead system with unique audibles	MTM	EAS
NT3X82AD	OAU dead system with common audibles	MTM	EAS
NT3X82AE	OAU dead system with unique audibles (-60V version)	MTM	EAS
NT3X82AF	OAU dead system with unique audibles	ISM	Version 2
NT3X82AG	OAU dead system with common audibles	ISM	Version 2
NT3X82AH	OAU dead system with unique audibles	ISM	EAS
NT3X82AJ	OAU dead system with common audibles	ISM	EAS
NT3X82AK	OAU dead system with unique audibles (-60V version)	ISM	EAS
NT3X82BA	LPA dead system with audibles and IATC	ISM	LPA

ALMSDGRP (continued)

In the LPA system, the OAU common and unique audibles are combined on the NT3X82BA card. The NT3X82BA also contains the inactive timing circuit (IATC).

The following table lists the SD and SC points for NT3X82AA, NT3X82AC, NT3X82AE, NT3X82AF, NT3X82AH, or NT3X82BA card in an OAU.

SD and SC points for NT3X82AA, NT3X82AC, NT3X82AE, NT3X82AF, NT3X82AH, or NT3X82BA in OAU

SD point	Function	Normal state	SC point	Function	Normal state
0	OAUFAIL	0	0	ABMTMFL	0
1	OAUPWR	0	1	AUDARO	0
2	MJALMAUD1	0	2	LOWBATT1	0
3	ABAUD	0	3	Not used	0
4	ABOAU	0	4	FEEDLOSS1	0
5	COMAUD	0	5	Internal circuit	0
6	Internal circuit	0	6	Internal circuit	0
7	Internal circuit	0	7	Internal circuit	0

The following table lists the SD and SC points for the NT3X82AA, NT3X82AC, NT3X82AE, NT3X82AF, NT3X82AH, or NT3X82BA cards in a standby MTM or ISM.

SD and SC points for NT3X82AA, NT3X82AC, NT3X82AE, NT3X82AF, NT3X82AH, or NT3X82BA in standby MTM or ISM (Sheet 1 of 2)

SD point	Function	Normal state	SC point	Function	Normal state
0	MTMFAIL	0	0	ABOAUFL	0
1	MTMPWR	0	1	AUDARM	0
2	MJALMAUD2	0	2	LOWBATT2	0
3	OAUFLAUD	0	3	Internal circuit	0
4	OAUFLVIS	0	4	FEEDLOSS2	0
5	COMAUD	0	5	Internal circuit	0

ALMSDGRP (continued)

SD and SC points for NT3X82AA, NT3X82AC, NT3X82AE, NT3X82AF, NT3X82AH, or NT3X82BA in standby MTM or ISM (Sheet 2 of 2)

SD point	Function	Normal state	SC point	Function	Normal state
6	Internal circuit	0	6	Internal circuit	0
7	Internal circuit	0	7	Internal circuit	0

The following table lists the SD and SC points for NT3X82AB, NT3X82AD, NT3X82AG, or NT3X82AJ cards in an OAU.

SD and SC points for NT3X82AB, NT3X82AD, NT3X82AG, or NT3X82AJ in OAU

SD point	Function	Normal state	SC point	Function	Normal state
0	OAUFAIL	0	0	ABMTMFL	0
1	OAUPWR	0	1	AUDARO	0
2	Internal circuit	0	2	LOWBATT1	0
3	Internal circuit	0	3	Internal circuit	0
4	OAUFLVIS	0	4	FEEDLOSS1	0
5	COMAUD1	0	5	Internal circuit	0
6	Internal circuit	0	6	Internal circuit	0

The following table lists the SD and SC points for NT3X82AB, NT3X82AD, NT3X82AG, or NT3X82AJ cards in a standby MTM or ISM.

SD and SC points for NT3X82AB, NT3X82AD, NT3X82AG, or NT3X82AJ in standby MTM or ISM (Sheet 1 of 2)

SD point	Function	Normal state	SC point	Function	Normal state
0	MTMFAIL	0	0	ABOAUFL	0
1	MTMPWR	0	1	AUDARM	0
2	Internal circuit	0	2	LOWBATT2	0
3	Internal circuit	0	3	Internal circuit	0
4	OAUFLVIS	0	4	FEEDLOSS2	0

ALMSDGRP (continued)**SD and SC points for NT3X82AB, NT3X82AD, NT3X82AG, or NT3X82AJ in standby MTM or ISM (Sheet 2 of 2)**

5	COMAUD2	0	5	Internal circuit	0
6	Internal circuit	0	6	Internal circuit	0

NT3X83 - OAU alarm transfer card

The OAU alarm transfer (NT3X83) cards in Version 2, EAS, and LPA OAU's contain SC and SD points. These cards contain two circuits. The even-numbered circuit contains SD points and the odd-numbered circuit contains SC points. The following table shows the versions of NT3X83 card.

NT3X83 versions

PEC	Card name	Shelf	OAS
NT3X83AA	OAU alarm transfer	MTM	Version 2, EAS
NT3X83AB	OAU alarm transfer (-60V version)	MTM	Version 2, EAS
NT3X83AC	OAU alarm transfer	ISM	Version 2, EAS
NT3X83AD	OAU alarm transfer (-60V version)	ISM	Version 2, EAS
NT3X83BA	LP alarm transfer & sending	ISM	LPA

In the LPA system, the OAU alarm sending function is on the NT3X83BA card. This function is on the NT3X84 card in alarm systems other than LPA. The NT3X83BA can be used in both -48V and -60V applications.

The following table lists the SD and SC points for the NT3X83 card.

SD and SC points for NT3X83 (Sheet 1 of 2)

SD point	Function	Normal state	SC point	Function	Normal state
0	ALMXFR	0	0	AXFRALM	0
1	MJXFR	0	1	REMOTEAR	0
2	MNXFR	0	2	130MONITOR	0
3	LN101TST	0	3	TTCNTXFR	0

ALMSDGRP (continued)**SD and SC points for NT3X83 (Sheet 2 of 2)**

SD point	Function	Normal state	SC point	Function	Normal state
4	NTALMXFR	0	4	TSTLN101	0
5	EXPILDMS	0	5	Internal circuit	0
6	EXPILPWR	0	6	Internal circuit	0

NT3X84 - OAU alarm sending card

The OAU alarm sending (NT3X84) cards in Version 2 and EAS OAU's contain both SC and SD points. These cards contain two circuits. The even-numbered circuit contains SD points and the odd-numbered circuit contains SC points. The following table lists the versions of NT3X84 card.

NT3X84 versions

PEC	Card name	Shelf	OAS
NT3X84AA	OAU alarm sending	MTM	Version 2, EAS
NT3X84AB	OAU alarm sending	ISM	Version 2, EAS

In the LPA system, the OAU alarm sending and alarm transfer functions are combined on the NT3X83BA card.

The following table lists SD and SC points for the NT3X84 card.

SD and SC points for NT3X84 (Sheet 1 of 2)

SD point	Function	Normal state	SC point	Function	Normal state
0	Internal circuit	0	0	Internal circuit	0
1	Internal circuit	0	1	Internal circuit	0
2	Internal circuit	0	2	TONEMONITOR	0
3	LN101TST	0	3	TTCNTXFR	0
4	NTALMXFR	0	4	TSTLN101	0
5	EXPILDMS	0	5	Internal circuit	0

ALMSDGRP (continued)**SD and SC points for NT3X84 (Sheet 2 of 2)**

SD point	Function	Normal state	SC point	Function	Normal state
6	EXPILPWR	0	6	Internal circuit	0
7	Internal circuit	0	7	Internal circuit	0

NT3X85 - OAU alarm group card

The OAU alarm group (NT3X85) cards in Version 2, EAS, and LPA OAU's contain both SC and SD points. These cards contain two circuits. The even-numbered circuit contains SD points and the odd-numbered circuit contains SC points. The following table shows the versions of NT3X85 card.

NT3X85 versions

PEC	Card name	Shelf	OAS
NT3X85AA	OAU alarm group	MTM	Version 2, EAS, LPA
NT3X85AB	OAU alarm group	ISM	Version 2, EAS, LPA

The following table lists the SD and SC points for the NT3X84 card.

SD and SC points for NT3X85

SD point	Function	Normal state	SC point	Function	Normal state
0	MJOTHVIS	0	0	CRSUCFLR	0
1	MNOTHVIS	0	2	MJSUCFLR	0
2	SUCFLRCR	0	2	MNSUCFLR	0
3	SUCFLRMJ	0	3	CRPREFLR	0
4	SUCFLRMN	0	4	MJPREFLR	0
5	PREFLRCR	0	5	MNPREFLR	0
6	PREFLRMJ	0	6	ALMGRP	0
7	PREFLRMN	0	7	Internal circuit	0

ALMSDGRP (continued)**NT2X57 - signal distribution card**

Each NT2X57 card provides 16 SD points. The card is divided into two SD groups. Each SD group has eight SD points (0 to 7). You assign a trunk module circuit number to each scan group.

The following table shows the SD point assignments for the first NT2X57 card. Each of the other NT2X57 cards has 14 customer-assignable SD points.

SD points for the first NT2X57

SD point	Function	Normal state	SD point	Function	Normal state
0	CRALMVIS	0	0	CRPWRVIS	0
1	MJALMVIS	0	1	MJPWRVIS	0
2	MNALMVIS	0	2	MNPWRVIS	0
3	PDCVIS	0	3	CRVISLOOP	0
4	ABSVIS	0	4	MJVISLOOP	0
5	CRALMAUD	0	5	MNVISLOOP	0
6	MNALMAUD	0	6	OAUVIS-LOOP	0
7	Internal circuit	0	7	Internal circuit	0

Functional description

Table ALMSDGRP stores alarm circuit equipment, location, and card type information. This table is a head table for table ALMSD.

Table ALMSDGRP has a fixed pseudo common language location identifier (CLLI) code of OAUSD. For information on the fixed CLLI code, see the description of table CLLI.

Datafill sequence and implications

Before you assign an SD group in table ALMSDGRP, verify that you have not already assigned the SD group in table SDGRP, SITE, NWMSD and NWMSD.NWMSDPT, or TMINV.

Table size

0 to 512 tuples

The maximum number of SD points you can assign is 1024.

ALMSDGRP (continued)

Memory for SD groups is automatically allocated.

Datafill

The following table lists datafill for table ALMSDGRP.

Field descriptions (Sheet 1 of 2)

Field	Subfield or refinement	Entry	Explanation and action
SDGROUP		0 to 512	<i>Signal distributor group</i> Enter the signal distribution group number.
TMTYPE		ATM, CTM, DTM, ISM, MTM, OAU, PTM, RMM, RSM, STM, TAN, TMA, TM2, TM4, TM8, orT8A	<i>Trunk module type</i> Enter the type of trunk module that contains the circuit. Note: Peripheral trunk modules (PTMs) are manufacture discontinued. PTMs that are datafilled as PTMs in table TMINV cause the failure of international 101 test lines. You must datafill PTMs as MTMs to avoid this problem.
TMNO		0 to 2047	<i>Trunk module number</i> Enter the number of the trunk module that contains the circuit. If the entry in field TMTYPE is OAU, enter 0. If the entry in field TMTYPE is MTM, enter 0 to 255. If the entry in field TMTYPE is RSM, enter 99.

ALMSDGRP (continued)**Field descriptions (Sheet 2 of 2)**

Field	Subfield or refinement	Entry	Explanation and action
TMCKTNO		0 to 29	<i>Trunk module circuit number</i> Enter the trunk module circuit number for the card.
CARDCODE		2X57AA	<i>Product engineering code</i>
		3X82AA	Enter the code (abbreviated PEC) for the alarm card.
		3X82AB	
		3X82AC	
		3X82AD	For Version 2 OAU on an MTM shelf, enter 3X82AA or 3X82AB.
		3X82AE	
		3X82AF	For EAS OAU on an MTM shelf, enter 3X82AC, 3X82AD, or 3X82AE.
		3X82AG	
		3X82AH	For Version 2 OAU on an ISM shelf, enter 3X82AF or 3X82AG.
		3X82AJ	
		3X82AK	
		3X82BA	For EAS OAU on an ISM shelf, enter 3X82AH, 3X82AJ, or 3X82AK.
		3X83AA	
		3X83AB	For LPA OAU, enter 3X82BA.
		3X83AC	
		3X83AD	
		3X83BA	
		3X84AA	
		3X84AB	
		3X85AA or	
		3X85AB	

Datafill example

The following example shows datafill in table ALMSDGRP for OAS Version 1.

ALMSDGRP (continued)**MAP display example for table ALMSDGRP**

SDGROUP	TMTYPE	TMNO	TMCKTNO	CARDCODE
0	OAU	0	0	2X57AA
1	OAU	0	1	2X57AA
2	OAU	0	2	2X57AA
3	OAU	0	3	2X57AA
4	OAU	0	4	2X57AA
5	OAU	0	5	2X57AA
6	MTM	4	2	2X57AA

Note: The entries for SD groups 0 to 5 are always required. These entries are related to the OAU.

Note: All remaining SD groups 6 to 255 depend on the function of the SD group.

For information on individual SD point assignments, see the description of table ALMSD.

SD group 6 must be mounted on the same MTM as the office alarm card #3 (NT2X43).

The next two examples are for OAS Version 2.

The first example is for a small office with the following features:

- Dead System Alarm with Common Audible
- Alarm Sending and Checking
- Frame Supervisory Panel Alarm for Two Aisles

ALMSDGRP (end)

MAP display example for table ALMSDGRP

SDGROUP	TMTYPE	TMNO	TMCKTNO	CARDCODE
0	MTM	0	0	3X82AA
1	MTM	4	0	3X82AB
2	MTM	0	2	3X84AA
3	MTM	0	6	2X57AA
4	MTM	0	7	2X57AA

The second example is for a large office with the following alarm features:

- Dead System Alarm with Unique Audible
- Remote Alarm Transfer
- Alarm Grouping
- Frame Supervisory Panel Alarm for Seven Aisles
- Enhanced Network Management

MAP display example for table ALMSDGRP

SDGROUP	TMTYPE	TMNO	TMCKTNO	CARDCODE
0	MTM	0	0	3X82AA
1	MTM	4	0	3X82AA
2	MTM	0	4	3X83AA
3	MTM	0	6	3X85AA
4	MTM	0	10	2X57AA
5	MTM	0	11	2X57AA
6	MTM	0	12	2X57AA

Table history

BASE11

Added information on the Low Power Alarm (LPA) system

BCS36

Deleted value 2X55AA from the valid entries for field CARDCODE

Added values 3X82AC and 3X82AD to the valid entries for field CARDCODE

AMAPARM**Table name**

AMAPARM

Functional description

This table contains default BAF table values and other information needed to generate BAF records on the CM. Note that this information was previously contained within MIBs, available to the SDM only.

Datafill sequence and implications

Table AMAPARM contains default values used for the BAF record creation. There are no datafill dependencies upon this table.

Table size

This minimum size of this table is 55 bytes and the maximum size of this table is 55 bytes.

Field descriptions

The following table describes field names, subfield names, and valid data ranges for table AMAPARM.

Field	Subfield or refinement	Entry	Explanation and action
PARMNAME			PARMNAME. All parm are present and may not be deleted. Parameters for PARMNAME are listed below.
	BAFSUPPR	N, Y	BAFSUPPR. BAF Suppression is used to indicate that suppression of the Recording Office Identification, Recording Office Type, Sensor Identification, and Sensor Type is active. If value is set to Y, then fields 2, 3, 4, 5 are not output. Default value is 'N'.
	CUSTRAO	0 TO 999	CUSTRAO. Customer RAO contains the default value of 0 used for the BAF Customer RAO (Revenue Accounting Office) Number table. This information is required for BAF table 46. Default value is 0.

AMAPARM (continued)

Field	Subfield or refinement	Entry	Explanation and action
	ENABLEAUDIT	N, Y	ENABLEAUDIT. Enable Audit indicates whether or not the Structure Codes 9042 and 9102 should be produced every hour on the hour. If set to 'Y' both records are produced. If set to 'N' neither record is produced. Default value is 'Y'.
	LOCATION	VECTOR OF UP TO 15 hexadecimal digits (up to 15 digits in the range 0 to 9, or 15 F's if not used)	LOCATION. Location stores the default value for the BAF Location table. Default value is FFFFFFFFFFFFFFFF.
	OPERACTN	0 TO 3	OPERACTN. Operator Action stores default value for the BAF Operator Action Table. Default value is 0.
	RECOFID	0 TO 999999	RECOFID. Recording Office Identification stores the default value for the BAF Recording Office Identification table. Default value is 0.
	RECOFTYP	0 TO 999	RECOFTYP. Recording Office Type stores the default value for the BAF Recording Office Type table. Default value is 0.
	RESETIME9042	0 TO 86399	RESETIME9042. 9042 Time Reset indicates how many seconds after midnight the CDR count is reset to zero. Structure 9042 displays the number of calls originated during the day. The count should get reset at midnight if RESETIME9042 is zero. Default value is 0.
	SCALLIND	0 TO 1	SCALLIND. Short Called Party Off-Hook Indicator stores the default value for the Short Called Party Off-Hook Indicator portion of the BAF Timing Indicator table. Default value is 0.
	SENSID	0 TO 999999	SENSID. Sensor Identification indicates the value to be placed within the BAF Sensor Identification table. Default value is 0.

AMAPARM (continued)

Field	Subfield or refinement	Entry	Explanation and action
	SENSTYPE	0 TO 999	SENSTYPE. Sensor Type indicates the value to be placed within the BAF Sensor Type table.
	SRVCOBS	0 TO 3	SRVCOBS. Service-Observed/Traffic-Sampled Indicator stores the default value used for the BA Service-Observed/Traffic-Sampled table. Default value is 0.
	SRVCPROV	VECTOR OF UP TO 9 hexadecimal digits (up to 9 digits in the range 0 to 9, or 9 F's if not used)	SRVCPROV. Service Provider Identity is used to indicate the value to be placed into the BAF Service Provider Identity table. Default value is FFFFFFFF.
	STUDYIND	0 TO 999999	STUDYIND. Study Indicator stores the default value of 0 for the BAF Study Indicator table. Default value is 0.

AMAPARM (end)

Datafill example

The following example shows datafill for table AMAPARM.

PARMNAME =====	PARMVAL =====
BAFSUPPR	N
CUSTRAO	0
ENABLEAUDIT	Y
LOCATION	FFFFFFFFFFFFFFFF
OPERACTN	0
RECOFID	0
RECOFTYP	0
RESETIME9042	0
SCALLIND	0
SENSID	0
SENSTYPE	0
SRVCOBS	0
SRVCPROV	FFFFFFFF
STUDYIND	0

Table history**UCS15**

Table AMAPARM created (A60009580).

AMAOPTS

Automatic Message Accounting Options

Table AMAOPTS is used to control the activation and scheduling of the recording options for automatic message accounting (AMA). Table AMAOPTS contains one tuple for every option, and initially contains the default values for each of these options. The default values of these options are dependent on the entry in field FORMAT in table CRSFMT where entry in field KEY is AMA. The entry in field FORMAT can be BCFMT (Bellcore format) for Bellcore offices, NTFMT (Nortel Networks format), or another format type for non-Bellcore offices. Some of the options replace office parameters that were used in earlier software releases.

These options cannot be deleted. Adds are performed to force a display of the contents of the table and to make the tuple known to the table editor to allow for changes to the tuple. By changing the scheduling information for the options, the operating company can activate, deactivate, and schedule the options at specified dates and times, and so control the output produced by the AMA system.

The initial contents of table AMAOPTS are defined at initial program load (IPL) time, but are not displayed in the table until the tuples have been added. To add entries without affecting the default scheduling values, use the selector DEFAULT in field AMASEL, and table control replaces the selector DEFAULT with the default value.

For example, to add the default entry DA411 to table AMAOPTS in field AMAOPT, enter the tuple DA411_DEFAULT. The entry DA411 OFF is displayed, indicating that the option is disabled as a default.

If the options that control unanswered call recording (UNANS_TOLL, UNANS_LOCAL, and UNANS_TOPS) are set to Y (yes), table BCCODES (formerly ATTCODES) must also be datafilled to route unanswered calls that are not equal access calls to the call recording. Call records are produced for all equal access calls, both answered and unanswered, regardless of the datafill in these tables. See table BCCODES for further explanation.

See the first table below for a description of available options. See the second and third tables below for the default schedule values for each

option, and see the fifth table for the allowable values of field AMASEL for each option.

Description of available options

Option	Explanation
ACBAR_MOD_CO	<p>This option provides a method of identifying any billable calls that are set up with Automatic Call Back (ACB) or Automatic Recall (AR) features, and includes a way of distinguishing calls to private numbers using ACB or AR. The setting of option ACBAR_MOD_CO determines whether features ACB and AR and the privacy status of a call are provided. The option ACBAR_MOD_CO is an ON or OFF parameter. If ACBAR_MOD_CO is set ON, features ACB and AR and the privacy status of a call are found in the appended module code 068. The information added to the billing record is interpreted by the downstream billing center. If it is a private number, the directory number (DN) is not printed on the subscriber's invoice. If option ACBAR_MOD_CO is set OFF, module code 068 is not appended; therefore, features ACB and AR and the privacy status information of a call are not provided. If option ACBAR_MOD_CO is set OFF, the DN of any private number is printed on the subscriber's invoice. The default value is OFF. Values other than ON, OFF, or DEFAULT are not valid.</p>
ACBAR_STY_IN	<p>This option provides a method of identifying any billable calls that are set up with ACB or AR features, and includes a way of distinguishing calls to private numbers using ACB or AR. The setting of option ACBAR_STY_IN determines whether features ACB and AR and the privacy status of a call are provided. The option ACBAR_STY_IN is an ON or OFF parameter. If option ACBAR_STY_IN is set ON, features ACB and AR and the privacy status of a call are found in character 5 of the study indicator. The information added to the billing record is interpreted by the downstream billing center. If it is a private number, the DN is not printed on the subscriber's invoice. If option ACBAR_STY_IN is set OFF, features ACB and AR and the privacy status of a call are not found in character 5 of the study indicator. If option ACBAR_STY_IN is set OFF, the DN of any private number is printed on the subscriber's invoice. The default value is OFF. Values other than ON, OFF, or DEFAULT are not valid.</p>
<p>Note: Originating equal access calls, both answered and unanswered, generate AMA records regardless of the datafill in tables AMAOPTS and BCCODES. For offices that require billing for all E800 calls, ensure that call codes 141 and 142 are datafilled against UNANS_TOLL.</p>	

Description of available options

Option	Explanation
AMATRKTG_A NS	This option controls the generation of the AMA record triggered by the option AMATTRKTG in table AMATKOPT for all calls or for answered calls only. If this option is on, the AMA records are generated only for answered calls.
APPEND_ISD N_CKT_ID	This option controls the production of the ISDN channel identifier (module 180) and trunk identification (module 181) module codes. This option gives office-wide control of these module codes. The module codes are produced for originating and terminating BRI and PRI ISDN calls. To turn on the recording of modules 180 and 181, set APPEND_ISDN_CKT_ID to ON. To stop the recording of modules 180 and 181, set APPEND_ISDN_CKT_ID to OFF. The default value for this option is OFF.
APPEND_PRI_ MODULE	This option controls the addition of AMA module 070/071 to billing records for PRI originating calls. This option can be set to ON or OFF. The default value is OFF. To turn on the recording of module 070 or 071, set APPEND_PRI_MODULE to ON. To turn off the recording of module 070 or 071, set APPEND_PRI_MODULE to OFF.
AR_BILLING	This option provides the possibility to append a module code 611 to the AMA record, to indicate that a call has been made using the AR/ARDDN (Automatic Recall/Automatic Recall with Dialable Directory Number) feature. If the option is set to ON, module code 611 with a generic context ID of SUSP (80024) is appended to the AMA record when such a call is made. If the option is set to OFF, a normal AMA record is generated.
AUDIT	This option controls the resetting of the internal AMA counts for the operational measurements (OM) tracer record and sets up the accumulated time change for the new day. This option cannot be changed, and appears for information only.
BACK_CHARG E	This option controls the addition of module 611 for backwards charging information on French Telephony User Part (FTUP). This activity sends charging information during the call to the (calling subscriber's) switch that performs the billing. This option allows the service provider to control the billing of the call.
<p>Note: Originating equal access calls, both answered and unanswered, generate AMA records regardless of the datafill in tables AMAOPTS and BCCODES. For offices that require billing for all E800 calls, ensure that call codes 141 and 142 are datafilled against UNANS_TOLL.</p>	

Description of available options

Option	Explanation
BCLID_USPAUD	<p>This option controls the generation of AMA records by the Bulk Calling Line Identification usage-sensitive pricing audit (BCLID_USPAUD) that is scheduled in table AMAOPTS. Option SUSP (subscriber usage-sensitive pricing) must be turned on to obtain BCLID_USP records. If a DN used as a BCLID group billing DN is also used as a Custom Local Area Signaling Services (CLASS) line with at least one CLASS display feature, then two AMA records are generated for the DN.</p> <p>Field USP in table BCLIDGRP controls the collection of AMA information for each group of BCLID subscribers. If field USP is datafilled Y (yes), AMA counts are collected for the group. The peg counts store the number of full calling DNs delivered and the combined number of PRIVATE and OUT-OF-AREA indications delivered. An AMA record is generated for each BCLID group that is datafilled for usage-sensitive pricing (USP).</p> <p>BCLID groups that are datafilled with N (no) in field USP in table BCLIDGRP are not billed on a usage-sensitive basis. No AMA records are generated for these BCLID groups.</p>
BCLONGCALL	This option allows setting of the record generation time for long-duration Bellcore format records.
CALL_FWD	This option controls the usage recording of Call Forwarding (CFW/CFX).
CALL_TIMECHANGE	<p>This option governs the triggering of the new time-change module on the AMA record. There are three possible values:</p> <ul style="list-style-type: none"> • ON: Enables this functionality if a time change (CI commands SETTIME or SETDATE) occurs during a call, the time-change module is appended to the resultant AMA record. • OFF: disables this functionality. This is the initial value. • DEFAULT: equates to OFF in all cases. When datafilling this tuple, option UNIVERSAL_AMA_BILLING in table OFCENG must be set to Y and option TIMECHANGE in table AMAOPTS must be set to OFF.
CAPTURE_CKTSZ_UNANS	This option controls the generation of MCI 098 for unanswered calls. When set to ON, the terminating circuit seizure date and time will be captured in MCI 098.
<p>Note: Originating equal access calls, both answered and unanswered, generate AMA records regardless of the datafill in tables AMAOPTS and BCCODES. For offices that require billing for all E800 calls, ensure that call codes 141 and 142 are datafilled against UNANS_TOLL.</p>	

Description of available options

Option	Explanation
CAPTURE_CLASS_SERV	<p>This option controls the capture of the Class of Service (COS) Index. When set to ON, the most recent Class of Service Index assigned to the originating trunk group will be captured in BCD char 6-9 of MCI 611. The MCI 611 together with the new Context ID (80058) will be attached to the AMA record. If table control is set to OFF a dummy value of Hex F will be captured in BCD char 6-9.</p> <p>By default the COS captured in MCI 611 will be the one entered in the table TRKOPTS. If the COS is overridden during the translations then the COS captured in the MCI 611 will be the COS entered in the table CLISRVPF. The COS value assigned to the call can range from 0 - 1023.</p> <p>If all the three table controls (CAPTURE_CLASS_SERV, CAPTURE_COMPL_CODE and CAPTURE_SAT_IND) are set to OFF then the MCI 611 with the new context ID (80058) will not be attached to the AMA record.</p>
<p>Note: Originating equal access calls, both answered and unanswered, generate AMA records regardless of the datafill in tables AMAOPTS and BCCODES. For offices that require billing for all E800 calls, ensure that call codes 141 and 142 are datafilled against UNANS_TOLL.</p>	

Description of available options

Option	Explanation
CAPTURE_COMPL_CODE	<p>This option controls the capture of the Completion code, representing the reason for the call termination. The completion code will be captured for either the: release cause, treatment or called/calling party disconnect.</p> <p>If the Release Cause is available, then the completion code corresponding to the Release Cause will be captured. If the Release Cause is not available, then the Treatment Code, if available, will be captured as the Completion Code. If neither are available, the Calling Party/Called Party disconnect information will be captured as the Completion Code.</p> <p>Completion Code Information is captured for the following protocols:</p> <ul style="list-style-type: none"> • ETSI ISUP V1 • ETSI ISUP V2 • IBN7 • FST R1 • FST R2 • RBTUP • BTUP • DPNSS <p>When set to ON, the reason for the call termination will be added to MCI 611 (BCD char 2-4) with the new Context ID (80058), and will be attached to the AMA record. The BCD char 1 will indicate the event in the call for which the completion code is captured. If table control is set to OFF a dummy value of Hex F will be captured in BCD char 1-4.</p> <p>If all the three table controls (CAPTURE_CLASS_SERV, CAPTURE_COMPL_CODE and CAPTURE_SAT_IND) are set to OFF then the MCI 611 with the new context ID (80058) will not be attached to the AMA record.</p>
<p>Note: Originating equal access calls, both answered and unanswered, generate AMA records regardless of the datafill in tables AMAOPTS and BCCODES. For offices that require billing for all E800 calls, ensure that call codes 141 and 142 are datafilled against UNANS_TOLL.</p>	

Description of available options

Option	Explanation
CAPTURE_INAP_CPC	This option controls the capture of INAP CPC. If the option is turned ON and if the call involves INAP, the INAP CPC, if it exists, is captured in the AMA module code 611 (Context ID: 80027).
CAPTURE_SAT_IND	<p>This option controls the capture of Satellite Indicator information. If the call involved a satellite circuit then this one bit flag is set to 1 (ON). Information in this field is based on the SAT field value that is datafilled against the originating trunk in table TRKSGRP. For ISUP (ETSI ISUP V1, ETSI ISUP V2, IBN7) and RBTUP protocols this information is based on the satellite information carried by the incoming IAM and the SAT field value that is datafilled against the originating trunk in the table TRKSGRP. The satellite circuit information is captured in the BCD char 5 of the MCI 611. MCI 611 with the new Context ID (80058) will be attached to the AMA record. If table control is set to '0' (OFF) a dummy value of Hex F will be captured.</p> <p>If all the three table controls (CAPTURE_CLASS_SERV, CAPTURE_COMPL_CODE and CAPTURE_SAT_IND) are set to OFF then the MCI 611 with the new context ID (80058) will not be attached to the AMA record.</p>
Note: Originating equal access calls, both answered and unanswered, generate AMA records regardless of the datafill in tables AMAOPTS and BCCODES. For offices that require billing for all E800 calls, ensure that call codes 141 and 142 are datafilled against UNANS_TOLL.	

Description of available options

Option	Explanation
CCBS_BILLING	<p>This option controls CCBS (Call Completion to Busy Subscriber) billing, adding usage billing for CCBS calls. It is possible to mark the billing record to indicate CCBS usage thereby providing the ability to charge for the successful usage of CCBS. The option can be set to either ON or OFF.</p> <p>If the option is set to ON, it indicates that CCBS usage billing indication will be provided in AMA records for CCBS originated calls. If the option is set to OFF, no CCBS usage billing will be provided.</p> <p>Indication of CCBS usage is provided for the following scenarios where CCBS has been initiated and the called party has become free:</p> <ul style="list-style-type: none"> • Originator ignores the ring back. • Originator answers the ring back call and disconnects immediately (before or after the called party has rung). • Ringing is applied to the called party and he doesn't answer. • A complete call setup occurs between the originator and the called party. In this scenario if an answer message is received with no charge indication then the record will be marked as unanswered with CCBS usage marked. <p>Note: This option applies to both IBN and EBS lines.</p> <p>The Service Feature field (Field 012) is used to indicate that CCBS usage has been successful. CCBS usage is marked with a service feature code of '029' in the billing record.</p> <p>Note: The service feature code value of '029' is also used to indicate BTUP CBWF usage.</p>
CCSADATA	<p>This option controls the precedence of Call Code 021 over Call Code 072 for Common Control Switching Arrangement (CCSA) data calls. It has no effect on non-data calls.</p> <p>A Call Code 072 record is produced for a CCSA data call if the CCSADATA option is set to the default value OFF.</p> <p>A Call Code 072 record is replaced by Call Code 021 if the call is a CCSA data call and the CCSADATA option is set to ON.</p>
<p>Note: Originating equal access calls, both answered and unanswered, generate AMA records regardless of the datafill in tables AMAOPTS and BCCODES. For offices that require billing for all E800 calls, ensure that call codes 141 and 142 are datafilled against UNANS_TOLL.</p>	

Description of available options

Option	Explanation
CDAR	This option controls the recording of customer-dialed account codes.
CDAR_EXTENDED	This option controls the generation of the AMA module code 850 for the capture of account codes.
CDRDUMP	This option controls the generation of an audit that provides a billing record for all calls in progress on the DMS-100E at a specified time. The default value for this option is OFF, which requires that the audit be explicitly set. Once the specified time for the audit run is reached, a copy of the call detail recording (CDR) for all calls in progress at that time is generated and sent to the respective AMA process.
CDRLONGCALL	This option controls the scheduling of a new audit to produce long-duration call CDRs (46-byte CDR format only). The first check occurs at the time specified by field START, followed by periodic checks with a period specified by field PERIOD. The option cannot be set with a period less than eight hours. ON enables the functionality. OFF disables the functionality. DEFAULT is PERIODIC with a period of eight hours, starting at the next occurrence of either 05:15, 13:15, or 21:15.
CDRSYNC	This option allows synchronization records (code 1B) to be added to the CDR data stream at intervals specified by the user. The option can be datafilled as OFF or PERIODIC. The CDR stream must be datafilled in field KEY of table CRSFMT before setting option CDRSYNC to PERIODIC. The default for this option is OFF and the format is CDR300FMT.
CHG411	This option controls charging for 411 directory assistance (DA) calls. Option DA411 must be set ON along with option CHG411 before local DA calls are written as charged. Local DA records are written as study records if option DA411 is set ON and option CHG411 is OFF.
CHG555	This option controls charging for seven-digit (555-1212) DA calls. Option DA555 must be set ON along with option CHG555 before 555 DA calls are written as charged. DA calls are written as study records if option DA555 is set ON and option CHG555 is OFF.
<p>Note: Originating equal access calls, both answered and unanswered, generate AMA records regardless of the datafill in tables AMAOPTS and BCCODES. For offices that require billing for all E800 calls, ensure that call codes 141 and 142 are datafilled against UNANS_TOLL.</p>	

Description of available options

Option	Explanation
CIDSUSPAUD	<p>This option controls the calling information delivery (CID) subscription usage-sensitive pricing (SUSP) audit that generates a billing record (for each Calling Number Delivery (CND), Dialable Number Delivery (DDN) and/or Calling Name Delivery (CNAMD) feature subscriber) that contains peg counts for each of the CLASS SUSP display options.</p> <p>If option SUSP in table AMAOPTS is ON or has been ON at any point during the audit period, then at the datafilled start time and interval, the audit produces a record for each subscription CNAMD or CND/DDN subscriber. A subscription option is one that has its billing option field set to AMA.</p> <p>If option SUSP in table AMAOPTS is OFF and has not been ON during the audit period, then the audit is not run and no records are produced.</p> <p>If a subscriber has not received any calls that increment the delivery counts for a CLASS SUSP display, then a record that contains 0 (zero) in the available and unavailable count fields for that option is produced if</p> <ul style="list-style-type: none"> • the CLASS SUSP display option is currently active • the CID options are enabled in table RESOFC • option SUSP was ON in table AMAOPTS during the last audit period <p>After the audit is complete, the AMA registers that are associated with each subscriber are set to 0 (zero) in preparation for the next audit period.</p> <p>Since this audit can produce many AMA records, we recommend that the operating company schedule the audit during low traffic hours and on a 24-h basis.</p> <p>The audit is not the only source of billing records. If a CLASS SUSP display option is changed to flat-rate or removed from the line, the delivery counts stored for the CLASS SUSP display option are reported in an AMA record appropriately.</p>
<p>Note: Originating equal access calls, both answered and unanswered, generate AMA records regardless of the datafill in tables AMAOPTS and BCCODES. For offices that require billing for all E800 calls, ensure that call codes 141 and 142 are datafilled against UNANS_TOLL.</p>	

Description of available options

Option	Explanation
	Value DEFAULT in NTFMT (Northern Telecom format) AMA switching units is OFF and cannot be changed. Value DEFAULT in BCFMT (Bellcore format) AMA switching units is PERIODIC and set to run once a day at midnight. Although option CIDSUSPAUD in table AMAOPTS cannot be turned off in a BCFMT switching unit, the audit does not run if option SUSP has been turned off since the last time the audit ran.
CITYWIDE	This option allows generation of billing records for intra-citywide virtual private network (VPN) calls that are normally non-billable. Value ON turns billing on. The default value is OFF. Values other than ON, OFF, or DEFAULT are not valid.
CLI_DELV	This option controls the capture of the CLI delivery indicator. If the option is turned ON, the CLI delivery indicator is captured in the AMA module code 611 (Context ID: 80058).
CMCICWK	For a terminating central message control (CMC) call, the carrier connect time is the time the incoming CMC trunk is seized. If option CMCICWK is set to ON, the carrier connect time on a CMC to feature group D (FGD) carrier call is the time of billing wink from the FGD carrier. A CMC access record is not created unless a billing wink is received from the FGD carrier.
CMCORIG	This option controls the generation of originating CMC billing records (call codes 63 and 64). If this option is set OFF, no call code 63 or 64 records are created.
CMCTERM	This option controls the generation of terminating CMC billing records (call codes 65 and 66). If this option is set to OFF, no call code 65 or 66 records are made.
COIN	This option controls the recording of all local coin calls.
COLL_SVC_BILL_INFO	This option controls the use of Japan billing enhancements. These enhancements have an effect on module codes 611 and 612. To enable Japan billing enhancements, set option COLL_SVC_BILL_INFO to ON. If this option is OFF, the switch ignores AMAOPTS options RECORD DIALED_DIGS and MC611_80005.
<p>Note: Originating equal access calls, both answered and unanswered, generate AMA records regardless of the datafill in tables AMAOPTS and BCCODES. For offices that require billing for all E800 calls, ensure that call codes 141 and 142 are datafilled against UNANS_TOLL.</p>	

Description of available options

Option	Explanation
CORRID	This option can be set to ON or OFF to enable or disable universal billing correlation identification (UBCID). When CORRID is set to ON, module code '613' is appended to the base billing record which requires the collection of the UBCID.
CRSEQNUM	This option controls the generation of a call record sequence number for each call record.
CRT_BILLING	This parameter controls billing records for the call redirect feature on an office-wide basis. CRT_BILLING set to ON creates a billing record for the redirected call. With CRT_BILLING set to OFF, a billing record does not generate for the redirected call.
CSMI	This option can be set to ON or OFF in order to enable or disable billing for CSMI.
DA411	This option controls the recording of calls to a local DA operator. Local DA calls are recorded as study records if option DA411 is set ON. DA calls are written as charged if options DA411 and the CHG411 are both set to ON.
DA555	This option controls the recording of seven-digit (555-1212) directory assistance calls. Ten-digit (NPA-555-1212) DA calls are always recorded as station-paid calls. DA 555 calls are recorded as study records if option DA555 is set ON. DA 555 calls are written as charged if options DA555 and CHG555 are both set ON.
DISABLE_MC D_ AMA	This option activates the Minimum Call Duration parameter used on DMS switches in Israel. DISABLE_MCD_ AMA supports special functionality for short calls that can be used by other customers. If the option is set ON, the Minimum Call Duration is activated. The default value is OFF.
ENABLE_SCI5 00	This option sets the AMA environment for DMS switches in Israel. ENABLE_SCI500 provides structure code 500 in Bellcore AMA records. If the option is set ON, the AMA environment is set up for the Israeli market. Option ENABLE_TLR_BILLING must be set ON before option ENABLE_SCI500 is activated. The default value is OFF. Any change in this option requires a reload restart.
<p>Note: Originating equal access calls, both answered and unanswered, generate AMA records regardless of the datafill in tables AMAOPTS and BCCODES. For offices that require billing for all E800 calls, ensure that call codes 141 and 142 are datafilled against UNANS_TOLL.</p>	

Description of available options

Option	Explanation
ENABLE_TLR_BILLING	This option sets the AMA environment for DMS switches in Israel. If the option is set ON, the AMA environment is set up for the Israeli market. The default value is OFF. This option controls TIV logs, generation of AMA record as a result of successful wake up request activation, generation of RBP log, implementation of OGINFO option in AMATKOPT, special Telrad implementation of CAMA, special service features in records of BOOMERANG and VML calls, sending of AMA records via MPC card, supporting of a special structure for BEARER_CAPABILITIES and SERVICE_FEATURE fields in the AMA record, implementation of FLEXCLI option in TRKOPTS table. If there is FLEXCLI option for the trunk group in TRKOPTS table, the modification of the CLI is done as written in FLEXDIGS table and the new DN is written in the record unit for AMA. Any change in this option requires a reload restart.
ENFIA_B_C	This option controls the AMA recording of ENFIA B and ENFIA C calls (for example, 950-10xx).
FREECALL	This option controls the recording of all local calls that terminate on a free number.
FTRCODE	This option indicates whether the originating and terminating feature codes in Bellcore AMA are required for international billing. Setting the tuple FTRCODE to ON results in module code 509 being appended to the 510 structure code if one of the recorded features is activated by either the calling or called party. TIMED and PERIODIC are not valid values, and are blocked when entered. The value DEFAULT sets the tuple to OFF.
GFTBILL	This option counts transport activities that have a generic function. This option appends the activities to the AMA billing record. Value ON turns billing on. The default value is OFF.
HIGHREV	This option suppresses the generation of all AMA data except for call types that are listed as high revenue in table BCCODES.
IC_CDPN_INFO_REQD	This option controls the capture of Incoming Called Party Number NPI and NOA or TON information. The FLEXCPNI option (subfield IC_CDPN_INFO) in tables AMAXLAID and FLEXAMA activates this capture.
<p>Note: Originating equal access calls, both answered and unanswered, generate AMA records regardless of the datafill in tables AMAOPTS and BCCODES. For offices that require billing for all E800 calls, ensure that call codes 141 and 142 are datafilled against UNANS_TOLL.</p>	

Description of available options

Option	Explanation
IC_CGPN_INFO_REQD	This option controls the capture of Incoming Calling Party Number (CGPN) Numbering Plan Indicator (NPI) and Nature Of Address (NOA) or Type Of Number (TON) information. The FLEXCPNI option (subfield IC_CGPN_INFO) in tables AMAXLAID and FLEXAMA activates this capture.
IC_CGPN_PI_REQD	This option provides a means to capture the incoming calling party's Presentation Indicator (PI) in AMA records and conveys the information about the Calling Line Identity (CLI) presentation or restriction.
INFO_DIGIT	This option controls whether an extra digit in the calling_dr field of the translation block in the CCB is copied into the calling_dr of the AMA PRU. When the option INFO_DIGIT is ON, the extra digit is not copied. When the option INFO_DIGIT is OFF, the extra digit is copied.
INTL_ICR_REQD	This option provides office-wide ICR activation for all IBN and BRI lines.
INTRASITE	This option allows generation of billing records for normally non-billable intra-site VPN calls. Value ON turns billing on. The default value is OFF. Values other than ON, OFF, or DEFAULT are not valid.
INWATS	This option controls the recording of all inward wide area telephone service (INWATS) calls.
ISDN_ACCIND	When set to ON, this option provides the correct ISDN access indicator value in the Module code 611 AMA billing record for the supported interworkings, providing the options COLL_SVC_BILL_INFO and MC611_80005 are also ON. When the ISDN_ACCIND option is set to OFF, the terminating ISDN indicator is recorded as 'unknown' for some of the supported interworkings in the Japan market.
ISDN_ETSIS	When set to ON, this option specifies that all ISDN PRI and BRI calls have a module code 030 appended to their AMA billing record.
<p>Note: Originating equal access calls, both answered and unanswered, generate AMA records regardless of the datafill in tables AMAOPTS and BCCODES. For offices that require billing for all E800 calls, ensure that call codes 141 and 142 are datafilled against UNANS_TOLL.</p>	

Description of available options

Option	Explanation
ISDNBBGBILL	<p>This option allows the production of billing records for basic business group (BBG) facilities and services on ISDN BRI lines. If ISDNBBGBILL is ON, the switch appends module code 074 to all ISDN BRI AMA records.</p> <p>Module code 074 identifies</p> <ul style="list-style-type: none"> • the BBG call type • the billing number of the BBG customer • the associated virtual facility group (VFG) or trunk group number (TGN) used in the call <p>This option applies only to ISDN BRI lines, and it controls the production of BBG billing records office-wide.</p>
ISDNCIRCUIT	<p>This option controls the production of the ISDN circuit structures and philosophies office-wide. The structures consist of ISDN core module 070/071 and ISDN terminating user service module 073. The philosophies consist of call types and allow the operating company to specify signaling capabilities that are considered a basis for originating or terminating detailed billing.</p>
LNID	<p>This option can only be OFF. This tuple is forced to OFF during a dump and restore or when operating company personnel attempt to change its value. This option controls the inclusion of a coded representation of the line ID in the AMA record. This option has no effect if entry in field FORMAT, in table CRSFMT, where field KEY = AMA, is NTFMT.</p>
LNP_721	<p>This option creates an LNP record for Bellcore call code 721. The option has values of ON, OFF, and DEFAULT. The default is OFF.</p>
LNP_721_Use SC0500	<p>This option creates an LNP record for Bellcore call type code 721 with structure code 500. The option has values of ON, OFF, and DEFAULT. The default is OFF. With this option OFF, LNP721 records generate with structure code 0001.</p>
LNP_721_ PortedDNOnly	<p>This option creates an LNP record for Bellcore call code 721 only when the dialed DN is ported. The option has values of ON, OFF, and DEFAULT. The default is OFF.</p>
<p>Note: Originating equal access calls, both answered and unanswered, generate AMA records regardless of the datafill in tables AMAOPTS and BCCODES. For offices that require billing for all E800 calls, ensure that call codes 141 and 142 are datafilled against UNANS_TOLL.</p>	

Description of available options

Option	Explanation
LNP_722	This option creates a last resort LNP record, Bellcore call code 722. Last resort AMA is generated when last resort routing to a recipient switch occurs at a donor switch and an AMA record is not already being generated at the donor switch. The option has values of ON, OFF, and DEFAULT. The default is OFF.
LNP_BILL_DONOR	This option is used to trigger AMA billing records at the donor exchange in LNP QoR calls.
LNP_MODULE_719	This option controls the kind of module that LNP appends to an AMA record. The default is OFF, which means that LNP stores portability information in module 720.
LOG117_CALLING_DN	This option controls whether the calling DN is copied into the AMAB117 log. ON copies the DN to AMAB117. OFF does not record the DN.
LOGAMA	This option controls the generation of AMAB117 log reports. If this option is set ON, AMAB117 log reports are generated for each record that is put on the AMA tape. (This is used instead of office parameter SPECIAL_AMA_REPORT in table OFCVAR.)
LOGOPT	This option controls the generation of a log outlining the status of the AMA recording options such as active or inactive.
LOGTEST	This option controls the generation of AMAB200 log reports. If it is set ON, AMAB200 log reports are generated for AMA billable calls to or from a line with the line option AMATEST enabled in table LENLINES.
LONGCALL	This option controls the production of AMA records periodically during the course of long-duration calls.
LUSORIG	This option controls the recording of all calls that originate on a line with line usage study (LUS) as defined in table LENFEAT.
LUSTERM	This option controls the recording of all calls that terminate on a line with LUS as defined in table LENFEAT.
<p>Note: Originating equal access calls, both answered and unanswered, generate AMA records regardless of the datafill in tables AMAOPTS and BCCODES. For offices that require billing for all E800 calls, ensure that call codes 141 and 142 are datafilled against UNANS_TOLL.</p>	

Description of available options

Option	Explanation
MC611_80005	This option controls the addition of module code 611 (80005) to AMA billing records for the office. To enable the recording of module code 611 (80005), set option MC611_80005 to ON. To disable the recording of module code 611 (80005), set option MC611_80005 to OFF. The default value for this option is OFF.
MWIC_AUDIT	This option provides the DMS-100 switch the ability to generate daily AMA records of aggregate counts of successful MWI control activations and deactivations on an MSRID basis. The MWIC_AUDIT option works in conjunction with the BILLNUM option of table MSRTAB. MWIC_AUDIT schedules the audit to capture the metrics of the new BILLNUM option.
NTAI	This option controls the generation of AMA Module 611 NTAI information switch-wide depending on the subfield ON/OFF setting.
OBSERVED	This option controls the recording of all calls that originate on a line with complaint observed studies (OBS) as defined in table LENFEAT.
OCCOVFL	This option controls the recording of equal access overflow calls (call code 120). Option OCCOVFL is dependent on the use of fixed pseudo-code EAPEG, which must be added to table CLLI and must be datafilled in table OFRT. When EAPEG is encountered in the route list of table OFRT, an overflow count is pegged against the destination carrier in table OCCINFO.
OCCTERM	This option controls the recording of terminating equal access calls (call code 119). If option OCCTERM is ON, these records are produced. If OCCTERM is OFF, these records are not produced. Note: The only option supported by GSF031 release for equal access is OCCTERM.
OUTWATS	This option controls the recording of all OUTWATS calls.
OVERFLOW	This option controls the recording of all INWATS or LUS calls that failed to terminate for any reason.
Note: Originating equal access calls, both answered and unanswered, generate AMA records regardless of the datafill in tables AMAOPTS and BCCODES. For offices that require billing for all E800 calls, ensure that call codes 141 and 142 are datafilled against UNANS_TOLL.	

Description of available options

Option	Explanation
RECORD_DIALED_DIGS	This option controls the addition of module code 040 to AMA billing records for the office. Module code 040 records the dialed digits received at call setup. To enable the recording of module code 040, set option RECORD_DIALED_DIGS to ON. To disable the recording of module code 040, set option RECORD_DIALED_DIGS to OFF. The default value for this option is OFF.
RECORD_LSP	This option enables the generation of LSPI recording on a switch-wide basis.
RECORD_NATIVE_LSPI	This option enables the generation of module codes 338 and 125, and LSPI call type codes 126, 127, and 128 on a switch-wide basis for native agents. Turn on the RECORD_LSPI option before using this option.
RECORD_RESOLD_LSPI	This option enables the generation of module codes 338 and 125, and LSPI call type codes 126, 127, and 128 on a switch-wide basis for resold agents. Turn on the RECORD_LSPI option before using this option.
RECORD_SIGNAL_LSPI	This option lets users add the MC338 (LSPI) module to the generated billing record on a switch-wide basis. The default value for this option is OFF, which deactivates the option. Note that users must also activate the RECORD_LSPI option in table AMAOPTS to activate the RECORD_SIGNAL_LSPI option. When both options are ON, the switch records the signaled LSPAO and LPSO information in module 338 and adds it to the billing record.
RECORD_TERMINATION	This option controls the recording of terminating information on trunk calls routed from the VPN trunk calls encountering busy or no-circuit problems.
RECORD_TRUNK_LSPI	This option controls the generation of trunk-related LSPI recording for selected inter-switch public trunk types. The default value is OFF, indicating that recording of trunk-related LSPI information is inactive on the switch. Turn on the RECORD_LSPI option before using this option.
<p>Note: Originating equal access calls, both answered and unanswered, generate AMA records regardless of the datafill in tables AMAOPTS and BCCODES. For offices that require billing for all E800 calls, ensure that call codes 141 and 142 are datafilled against UNANS_TOLL.</p>	

Description of available options

Option	Explanation
RECORD_UNBUND_LSPI	This option enables the generation of module codes 338 and 125, and LSPI call type codes 126, 127, and 128 on a switch-wide basis for unbundled agents. Turn on the RECORD_LSPI option before using this option.
SAID_MOD_SUPPR	This option controls the production of module 047 on an office-wide basis. Module 047 is appended for Speech Activated Intelligent Dialing calls. To stop the generation of module 047, set SAID_MOD_SUPPR to ON. To enable the generation of module 047, set SAID_MOD_SUPPR to OFF.
STORE_CALLREF	This option enables the capture of Call identity and Point code in the AMA billing record. These values are obtained from the Call Reference Parameter in the IAM message. The default value is OFF, which deactivates this option. The STORE_CALLREF option works in conjunction with the TRKOPTS option CALLREF for ETSI ISUP V2 trunks.
STORE_LRN	This option is used to trigger additional AMA billing module 612 for ported-in number originated calls.

Note: Originating equal access calls, both answered and unanswered, generate AMA records regardless of the datafill in tables AMAOPTS and BCCODES. For offices that require billing for all E800 calls, ensure that call codes 141 and 142 are datafilled against UNANS_TOLL.

Description of available options

Option	Explanation
SUSP	<p>This option controls SUSP.</p> <p>If option SUSP is OFF (the default)</p> <ul style="list-style-type: none"> • no SUSP billing occurs • service order prompting for SUSP is suppressed <p>If option SUSP is ON</p> <ul style="list-style-type: none"> • service order prompting for BILLING_OPTION is enabled • SUSP billing is enabled for the office (and SUSP billing takes place on lines that have the AMA BILLING_OPTION) <p>SUSP records are not recorded under any conditions if parameter AMA_FORMAT is NT.</p> <p>SUSP is also provided for the screening list editing (SLE) features: Selective Call Forwarding (SCF), Selective Call Rejection (SCRJ), Selective Call Acceptance (SCA), and Distinctive Ringing/Call Waiting (DRCW). The usage-sensitive context here means generating billing records each time the subscriber accesses an SLE USP feature screening list or activates or deactivates a SLE USP feature. Billing records are not generated each time a terminating call is screened by a subscriber's SLE USP feature.</p> <p>To enable usage-sensitive pricing (USP) for SLE features</p> <ul style="list-style-type: none"> • the feature or features must be enabled in table RESOFC • the feature or features must be assigned to a line • the SUSP entry in table AMAOPTS must be set ON • the BILLING_OPTION prompt, which is displayed when adding or changing an SLE feature, must be set to AMA
TIMECHANGE	<p>This option controls the generation of time-change records if the time or date on the switch is set by the command interpreter (CI) commands SETTIME or SETDATE at a maintenance and administration position (MAP) terminal.</p>
TRACER	<p>This option controls the production of an AMA tracer record containing peg counts of several AMA events such as originations or records output.</p>
<p>Note: Originating equal access calls, both answered and unanswered, generate AMA records regardless of the datafill in tables AMAOPTS and BCCODES. For offices that require billing for all E800 calls, ensure that call codes 141 and 142 are datafilled against UNANS_TOLL.</p>	

Description of available options

Option	Explanation
TRKID	This option can only be OFF. This tuple is forced to OFF during a dump and restore or when operating company personnel attempt to change its value. This option controls the inclusion of a coded representation of the terminating trunk ID in the AMA record. This option has no effect when parameter AMA_FORMAT is NT.
TRMTID_CAPTURE	This option controls the capture of the treatment ID applied to calls that have failed to be routed out of the DMS-100 switch. With this option ON, any billable calls that fail on 2-way or incoming ISUP, BTUP, FST R1, FST R2, RBTUP, ETSI PRI and DPNSS trunks result in the generation of an AMA module code130 with call characteristic value 10.
TWC	This option controls the usage recording of three-way calling (3WC).
U3WC	This option controls the usage recording of three-way calling - usage sensitive (U3WC).
UNANS_AIN	This option controls Advanced Intelligent Network (AIN) specific unanswered call recording. If option UNANS_AIN is turned on, an AMA record is produced for every unanswered billable AIN call whose call type is datafilled in tuple AIN in table BCCODES. If switch-based unanswered call recording is in effect for a certain call type, then unanswered AIN calls of that call type are recorded, regardless of whether or not UNANS_AIN is turned ON. The default value is OFF.
UNANS_LOCAL	This option controls the recording of unanswered local calls. Only those local calls that generate AMA records are recorded. The call is defined as toll, local, high revenue, or Traffic Operator Position System (TOPS) in table BCCODES. The unanswered calls must have the associated call code datafilled in table BCCODES. If option UNANS_LOCAL is set ON, answered and unanswered local calls are recorded. (Equal access calls are unaffected; see note.) If the unanswered call is a billable Capability Set 1 Revised (CS-1R) call, an AMA record is generated regardless of what UNANS_LOCAL is set to. A CS-1R call is billable if a furnish charging information (FCI) operation is received from the SCP for that call.
<p>Note: Originating equal access calls, both answered and unanswered, generate AMA records regardless of the datafill in tables AMAOPTS and BCCODES. For offices that require billing for all E800 calls, ensure that call codes 141 and 142 are datafilled against UNANS_TOLL.</p>	

Description of available options

Option	Explanation
UNANS_TOLL	This option controls the recording of unanswered toll calls. Only those toll calls that generate AMA records are recorded. The call is defined as toll, local, high revenue, or TOPS in table BCCODES. The unanswered calls must have the associated call code datafilled in table BCCODES. If option UNANS_TOLL is set to ON, answered and unanswered toll calls are recorded. Option UNANS_TOLL is used instead of office parameter, NO_ANS_CALLS_ONTAPE in table OFCENG. (Equal access calls are unaffected; see note.) If the unanswered call is a billable CS-1R call, an AMA record is generated regardless of what UNANS_TOLL is set to. A CS-1R call is billable if a furnish charging information (FCI) operation is received from the SCP for that call.
UNANS_TOPS	This option controls the recording of unanswered TOPS calls. Only those TOPS calls that generate AMA records are recorded. The call is defined as toll, local, high revenue, or TOPS in table BCCODES. The unanswered calls must have the associated call code datafilled in table BCCODES. If the option UNANS_TOPS is set ON, answered and unanswered TOPS calls are recorded. (Equal access calls are unaffected; see note.)
<p>Note: Originating equal access calls, both answered and unanswered, generate AMA records regardless of the datafill in tables AMAOPTS and BCCODES. For offices that require billing for all E800 calls, ensure that call codes 141 and 142 are datafilled against UNANS_TOLL.</p>	

In table CRSFMT, if the entry in field KEY is AMA, and the entry in field FORMAT is BCFMT (Bellcore format), the default values for the options in table AMAOPTS are as listed in the following table.

Default schedule values for Bellcore format options

Option	Default schedule
ACBAR_MOD_CO	OFF
ACBAR_STY_IN	OFF
AMATRKTG_ANS	OFF
APPEND_ISDN_CKT_ID	OFF
<p>Note: yymmdd is the date at initial program load (IPL) time, and hh00 is the time at IPL.</p>	

Default schedule values for Bellcore format options

Option	Default schedule
APPEND_PRI_MODULE	OFF
AR_BILLING	OFF
AUDIT	PERIODIC yymmdd 0000 24 HRS
BCLID_USPAUD	PERIODIC yymmdd 0000 24 HRS
BCLONGCALL	PERIODIC yymmdd 0000 24 HRS
CALL_FWD	ON
CALL_TIMECHG	OFF
CAPTURE_CKTSZ_UNANS	OFF
CAPTURE_CLASS_SERV	OFF
CAPTURE_COMPL_CODE	OFF
CAPTURE_INAP_CPC	OFF
CAPTURE_SAT_IND	OFF
CCBS_BILLING	OFF
CCSADATA	OFF
CDAR	OFF
CDAR_EXTENDED	OFF
CDRDUMP	OFF
CDRLONGCALL	PERIODIC
CHG411	OFF
CHG555	OFF
Note: yymmdd is the date at initial program load (IPL) time, and hh00 is the time at IPL.	

Default schedule values for Bellcore format options

Option	Default schedule
CIDSUSPAUD	PERIODIC yymmdd 0000 24 HRS
CITYWIDE	OFF
CLI_DELV	OFF
CMCICWK	OFF
CMCORIG	OFF
CMCTERM	OFF
COIN	OFF
COLL_SVC_BILL_INFO	OFF
CORRID	ON
CRSEQNUM	OFF
CRT_BILLING	OFF
CSMI	ON
DA411	OFF
DA555	OFF
DSCWID_CONF_AUDIT	OFF
ENFIA_B_C	ON
FREECALL	OFF
FTRCODE	OFF
GFTBILL	OFF
HIGHREV	OFF
INTL_ICR_REQD	OFF
Note: yymmdd is the date at initial program load (IPL) time, and hh00 is the time at IPL.	

Default schedule values for Bellcore format options

Option	Default schedule
INTRASITE	OFF
INWATS	OFF
ISDN_ACCIND	OFF
ISDNBBGBILL	OFF
ISDNCIRCUIT	OFF
LNID	OFF
LNP_BILL_DONOR	OFF
LOGAMA	OFF
LOGOPT	PERIODIC yymmdd 1200 24 HRS
LOGTEST	OFF
LONGCALL	PERIODIC yymmdd 0000 24 HRS
LUSORIG	OFF
LUSTERM	OFF
MC611_80005	OFF
MWIC_AUDIT	PERIODIC yymmdd 0000 24 HRS
NTAI	OFF
OBSERVED	OFF
OCCOVFL	PERIODIC yymmdd 2300 1 HRS
OCCTERM	ON
OUTWATS	OFF
Note: yymmdd is the date at initial program load (IPL) time, and hh00 is the time at IPL.	

Default schedule values for Bellcore format options

Option	Default schedule
OVERFLOW	PERIODIC yymmdd 2300 24 HRS
RECORD_DIALED_DIGS	OFF
RECORD_LPSI	OFF
RECORD_NATIVE_LSPI	OFF
RECORD_RESOLD_LSPI	OFF
RECORD_SIGNAL_LSPI	OFF
RECORD_TERMINATION	OFF
RECORD_TRUNK_LSPI	OFF
RECORD_UNBUND_LSPI	OFF
SAID_MOD_SUPPR	OFF
STORE_CALLREF	OFF
STORE_LRN	OFF
SUSP	OFF
TIMECHANGE	OFF
TRACER	PERIODIC yymmdd hh00 1 HRS
TRKID	OFF
TWC	ON
U3WC	ON
UNANS_AIN	OFF
UNANS_LOCAL	OFF

Note: yymmdd is the date at initial program load (IPL) time, and hh00 is the time at IPL.

Default schedule values for Bellcore format options

Option	Default schedule
UNANS_TOLL	OFF
UNANS_TOPS	OFF
Note: yymmdd is the date at initial program load (IPL) time, and hh00 is the time at IPL.	

In table CRSFMT, if the entry in field KEY is AMA, and the entry in field FORMAT is NTFMT (Nortel Networks format) or another non-Bellcore format, the default values for the options in table AMAOPTS are listed in the following table.

Default schedule values for non-Bellcore format options

Option	Default schedule
AR_BILLING	OFF
AUDIT	PERIODIC yymmdd 0000 24 HRS
CALL_FWD	OFF
CCSADATA	OFF
CDAR	OFF
CDRDUMP	OFF
CDRLONGCALL	PERIODIC
CDRSYNC	OFF
CHG411	OFF
CHG555	OFF
CIDSUSPAUD	OFF
COIN	OFF
DA411	OFF
Note: yymmdd is the date at IPL time, and hh00 is the time at IPL.	

Default schedule values for non-Bellcore format options

Option	Default schedule
DA555	OFF
ENFIA_B_C	ON
FREECALL	OFF
HIGHREV	OFF
INWATS	OFF
LNID	OFF
LOGAMA	OFF
LOGOPT	OFF
LONGCALL	PERIODIC yymmdd hhmm 1 HRS
LUSORIG	OFF
LUSTERM	OFF
OBSERVED	OFF
OCCOVFL	PERIODIC yymmdd 2300 1 HRS
OCCTERM	ON
OUTWATS	OFF
OVERFLOW	OFF
STORE_CALLREF	OFF
TIMECHANGE	OFF
TRACER	OFF
TRKID	OFF
TWC	OFF
Note: yymmdd is the date at IPL time, and hh00 is the time at IPL.	

Default schedule values for non-Bellcore format options

Option	Default schedule
UNANS_LOCAL	OFF
UNANS_TOLL	OFF
UNANS_TOPS	OFF
Note: yymmdd is the date at IPL time, and hh00 is the time at IPL.	

In table CRSFMT, if the entry in field KEY is AMA, and the entry in field FORMAT is BCFMT (Bellcore format), the allowable values for field AMASEL in table AMAOPTS are as listed in the following table.

Allowable AMASEL values for each Bellcore format option

Option	ON	OF	TIME	PERIODI	DEFAU
		F	D	C	LT
ACBAR_MOD_CO	X	X			X
ACBAR_STY_IN	X	X			X
AMATRKTG_ANS	X	X			X
APPEND_ISDN_CKT_ID	X	X			X
APPEND_PRI_MODULE	X	X			X
AUDIT					X
BCLID_USPAUD	X	X	X		X
BCLONGCALL				X	X
CALL_FWD	X	X	X		X
CALL_TIMECHG	X	X			X
CAPTURE_CKTSZ_UNANS	X	X			X
CAPTURE_CLASS_SERV	X	X			X

Allowable AMASEL values for each Bellcore format option

Option	ON	OF	TIME	PERIODI	DEFAU
		F	D	C	LT
CAPTURE_COMPL_CODE	X	X			X
CAPTURE_INAP_CP C	X	X			X
CAPTURE_SAT_IND	X	X			X
CCBS_BILLING	X	X			X
CCSADATA	X	X			X
CDAR	X	X	X		X
CDAR_EXTENDED	X	X			X
CDRDUMP		X		X	X
CDRLONGCALL	X	X		X	X
CHG411	X	X	X		X
CHG555	X	X	X		X
CIDSUSPAUD				X	X
CITYWIDE	X	X			X
CLI_DELV	X	X			X
CMCICWK	X	X	X		X
CMCORIG	X	X	X		X
CMCTERM	X	X	X		X
COIN	X	X	X		X
COLL_SVC_BILL_INF O	X	X			X
CORRID	X	X			X
CRSEQNUM	X	X			X

Allowable AMASEL values for each Bellcore format option

Option	ON	OF	TIME	PERIODI	DEFAU
		F	D	C	LT
CRT_BILLING	X	X			X
CSMI	X	X			X
DA411	X	X	X		X
DA555	X	X	X		X
DSCWID_CONF_AUDIT		X		X	X
ENFIA_B_C	X	X	X		X
FREECALL	X	X	X		X
FTRCODE	X	X			X
HIGHREV		X	X		X
INTL_ICR_REQD	X	X			X
INTRASITE	X	X			X
INWATS	X	X	X		X
ISDN_ACCIND	X	X			X
ISDNBBGBILL	X	X			X
ISDNCIRCUIT	X	X	X		X
LNID		X			X
LNP_BILL_DONOR	X	X			X
LOGAMA	X	X	X		X
LOGOPT		X		X	X
LOGTEST	X	X			X
LONGCALL				X	X
LUSORIG	X	X	X		X

Allowable AMASEL values for each Bellcore format option

Option	ON	OF	TIME D	PERIODI C	DEFAU LT
LUSTERM	X	X	X		X
MC611_80005	X	X			X
MWIC_AUDIT		X		X	X
OBSERVED	X	X	X		X
OCCOVFL	X	X	X	X	X
OCCTERM	X	X	X		X
OUTWATS	X	X	X		X
OVERFLOW		X		X	X
RECORD_DIALED_DIGS	X	X			X
RECORD_LPSI	X	X			X
RECORD_NATIVE_LSPI	X	X			X
RECORD_RESOLD_LSPI	X	X			X
RECORD_SIGNAL_LSPI	X	X			X
RECORD_TRUNK_LSPI	X	X			X
RECORD_UNBUND_LSPI	X	X			X
SAID_MOD_SUPPR	X	X			X
STORE_CALLREF	X	X			X
STORE_LRN	X	X			X
SUSP	X	X	X		X
TIMECHANGE	X	X			X

Allowable AMASEL values for each Bellcore format option

Option	ON	OF	TIME	PERIODI	DEFAU
		F	D	C	LT
TRACER		X		X	X
TRKID		X			X
TWC	X	X	X		X
U3WC	X	X	X		X
UNANS_AIN	X	X	X		X
UNANS_LOCAL	X	X	X		X
UNANS_TOLL	X	X	X		X
UNANS_TOPS	X	X	X	X	X

In table CRSFMT, if the entry in field KEY is AMA, and in field FORMAT is NTFMT (Nortel format) or other non-Bellcore format, the allowable values for field AMASEL in table AMAOPTS are as listed in the following table.

Allowable AMASEL values for each non-Bellcore format option

Option	ON	OF	TIME	PERIODI	DEFAU
		F	D	C	LT
AUDIT					X
APPEND_ISDN_CKT_ID	X	X			X
CALL_FWD		X			X
CCSADATA	X	X			X
CDAR		X			X
CDRDUMP		X		X	X
CDRLONGCALL	X	X		X	X
CDRSYNC		X		X	X
CHG411		X			X

Allowable AMASEL values for each non-Bellcore format option

Option	ON	OF	TIME	PERIODI	DEFAU
		F	D	C	LT
CHG555		X			X
CIDSUSPAUD		X			X
COIN		X			X
DA411		X			X
DA555		X			X
ENFIA_B_C		X			X
FREECALL		X			X
HIGHREV		X			X
INWATS		X			X
LNID		X			X
LOGAMA		X			X
LOGOPT		X			X
LONGCALL				X	X
LUSORIG		X			X
LUSTERM		X			X
OBSERVED		X			X
OCCOVFL	X	X	X	X	X
OCCTERM	X	X	X		X
OUTWATS		X	X		X
OVERFLOW		X		X	X
SAID_MOD_SUPPR	X	X			X
STORE_CALLREF	X	X			X
TIMECHANGE		X			X

Allowable AMASEL values for each non-Bellcore format option

Option	ON	OF	TIME	PERIODI	DEFAU
		F	D	C	LT
TRACER		X			X
TRKID		X			X
TWC		X			X
UNANS_LOCAL		X			X
UNANS_TOLL		X			X
UNANS_TOPS		X			X

Datafill sequence and meaning

Table CRSFMT must be datafilled before table AMAOPTS.

Table size

Table size is determined by the number of options currently supported. This number is static.

Datafill

The following table lists datafill for table AMAOPTS.

Field descriptions

Field	Subfield	Entry	Explanation and action
OPTION		see subfield	<i>Option</i> This field consists of subfield AMAOPT.
	AMAOPT	alphanumeric	<i>AMA option</i> Enter one of the option values listed in the first table in this chapter.
SCHEDULE		see subfields	<i>Schedule</i> This field consists of subfields AMASEL, ONDATE, OFFDATE, SCHED, ONTIME, and OFFTIME.

Field descriptions

Field	Subfield	Entry	Explanation and action
	AMASEL	ON, OFF, DEFAULT, PERIODIC, TIMED	<p><i>AMA selector</i></p> <p>Enter one of the values listed in the fourth and fifth tables in this chapter.</p> <ul style="list-style-type: none"> • ON: Activate the option immediately. • OFF: Deactivate the option immediately. • DEFAULT: Use the default schedule for the option. The value DEFAULT never appears in table AMAOPTS, since table control replaces it with the actual default value; details are shown in the cross-reference tables in this chapter. The DEFAULT selector can be used at any time and the switch recalculates the default value if the default AMASEL value is PERIODIC. • PERIODIC: Activate the option at the specified date and time and perform the activity periodically at the interval specified. Datafill subfields ONDATE and ONTIME to specify the date and time for activation, and datafill SCHED for the time intervals at which to perform the activity. For PERIODIC refinements, refer to AMASEL=PERIODIC conditional datafill table. • TIMED: Activate the option between the specified dates and times. Datafill refinements ONDATE and ONTIME to activate the option, and refinements OFFDATE and OFFTIME to deactivate the option. For TIMED refinements, refer to AMASEL=TIMED conditional datafill table.

AMASEL = PERIODIC

If the entry in subfield AMASEL is PERIODIC, datafill refinements ONDATE, ONTIME, SCHED, TV, and TU as described in the following table.

Field descriptions for conditional datafill

Field	Subfield	Entry	Explanation and action
	ONDATE	0 to 9 (6 digits)	<i>Activation on date</i> Enter the year, followed by the month, followed by the day (yymmdd) on which the activation of the option is set to ON. For example, 821105.
	ONTIME	0 to 9(4 digits)	<i>Activation on time</i> Enter the hour, followed by the minute (hhmm) on which the activation of the option is set to ON. For example, an ON time of 1:45 p.m. is entered as 1345.
	SCHED	see subfields	<i>Periodic schedule</i> This field consists of subfields TV and TU.
	TV	0 to 255	<i>Time value</i> Enter the time value for periodic scheduling. For example, an entry of 9, activates the option for the period of time units selected in subfield TU.
	TU	HRS, MINS, or SECS	<i>Time unit</i> Enter the time unit for the time value selected in subfield TV.
Note: Years 82 to 99 mean 1982 to 1999, while years 00 to 81 mean 2000 to 2081. Dates that are past cannot be entered in this field by the commands CHANGE or ADD.			

AMASEL = TIMED

If the entry in subfield AMASEL is TIMED, datafill refinements ONDATE, ONTIME, OFFDATE, and OFFTIME, as described in the following table.

Field descriptions for conditional datafill

Field	Subfield	Entry	Explanation and action
	ONDATE	0 to 9 (maximum 6 digits)	<i>Activation on date</i> Enter the year, followed by the month, followed by the day (yymmdd) on which the activation of the option is set to ON. For example, 821105.
	ONTIME	0 to 9 (maximum 4 digits)	<i>Activation on time</i> Enter the hour, followed by the minute (hhmm) on which the activation of the option is set to ON. For example, an ON time of 1:45 p.m. is entered as 1345.
	OFFDATE	0 to 9 (maximum 6 digits)	<i>Activation off date</i> Enter the year, followed by the month, followed by the day (yymmdd) on which the activation of the option is set to OFF. For example, 821106.
	OFFTIME	0 to 9 (maximum 4 digits)	<i>Activation off time</i> Enter the hour, followed by the minute (hhmm) on which the activation of the option is set to OFF. For example, an OFF time of 11:00 p.m., is entered as 2300.
Note: Years 82 to 99 mean 1982 to 1999, while years 00 to 81 mean 2000 to 2081. Dates that are past cannot be entered in this field by commands CHANGE or ADD.			

Datafill example

The following example shows sample datafill for table AMAOPTS.

MAP display example for option CCBS_BILLING in table AMAOPTS

OPTION	SCHEDULE
CCBS_BILLING	ON

MAP display example for table AMAOPTS

OPTION	SCHEDULE
ACBAR_MOD_CO	OFF
RECORD_SIGNAL_LSPI	OFF
INTL_ICR_REQD	ON

MAP display example for option LNP_BILL_DONOR in table AMAOPTS

OPTION	SCHEDULE
LNP_BILL_DONOR	ON

MAP display example for option RECORD_TRUNK_LSPI in table AMAOPTS

OPTION	SCHEDULE
RECORD_TRUNK_LSPI	ON

MAP display example for option NTAI in table AMAOPTS

OPTION	SCHEDULE
NTAI	OFF

MAP display example for option STORE_CALLREF in table AMAOPTS

OPTION	SCHEDULE
STORE_CALLREF	ON

MAP display example for option STORE_LRN in table AMAOPTS

OPTION	SCHEDULE
STORE_LRN	ON

MAP display example for option CAPTURE_CKTSZ_UNANS in table AMAOPTS

OPTION	SCHEDULE
CAPTURE_CKTSZ_UNANS	ON

MAP display example for option TRMTID_CAPTURE in table AMAOPTS

OPTION	SCHEDULE
TRMTID_CAPTURE	ON

MAP display example for options CAPTURE_CLASS_SERV, CAPTURE_COMPL_CODE and CAPTURE_SAT_IND in table AMAOPTS

OPTION	SCHEDULE
CAPTURE_COMPL_CODE	ON
CAPTURE_CLASS_SERV	ON
CAPTURE_SAT_IND	ON

MAP display example for option AR_BILLING in table AMAOPTS

OPTION	SCHEDULE
AR_BILLING	ON

Error messages

The following table explains error messages that can occur when you attempt to datafill table AMAOPTS.

Message	Explanation	User action
ERROR: LNP Billing options may not be activated unless Software Optionality Control option LNP00200 is ON.	SOC option LNP00200 is in the IDLE state.	Activate SOC option LNP00200. Activate the LNP billing option (again).

Table history**(I)SN08**

Universal Billing Correlation ID (CORRID) option added for the North American market by feature A00007752.

AMCODE

Table name

Ambiguous Code Table

Functional description

Table AMCODE is divided into subtables with each subtable identified by a unique XLANAME, previously datafilled in table AMHEAD. Each ambiguous code subtable translates one ambiguous code. Each ambiguous code subtable can have any number of tuples, but each subtable usually has two entries.

Datafill sequence and implications

The following tables must be datafilled before table xxCODE of the same system name:

- ACHEAD
- CTHEAD
- FAHEAD
- FTHEAD
- NSCHEAD
- OFCHEAD
- PXHEAD
- AMHEAD
- CDNCHAR
- NSCDEFS (if translation selector DBQ is used)
- TRKSGRP (if optional selector CGNDM for translation selector DMOD is used)

Note: The NSCDEFS table requires datafill first only for the Global software load.

If the optional selector CGNDM is used with translation selector DMOD, the default Calling Line Identity (CLI) must be datafilled in table TRKSGRP. Different default CLIs can be datafilled on requirements.

Optional selector CGNDM must also be datafilled in table ACCODE to activate the feature.

AMCODE (continued)

Only automatic number identification (ANI) and international metering (MTR) trunk group originations currently support the option selector CAMA. All other call types ignore this translation option.

For emergency calls translation, class EMRG has to be datafilled. This can be done before or after datafilling translation selector DMOD with option selector COODM. This requirement differentiates between normal mobile originated calls and emergency calls set up by a conventional SETUP message.

The following office parameters affect table ACCODE:

- ICAMA_REQUESTED in table OFCVAR
- IAA_REQUESTED in table OFCVAR
- IMEI_ACCEPTABLE_FOR_EMRG_CALL in table OFCVAR

For option selector CAMA (used in translation selectors CONT, DNRTE, and RTE), set office parameter ICAMA_REQUESTED in table OFCVAR to Y (yes) if international centralized automatic message accounting (ICAMA) detailed call recording is required.

An IAA record can be generated by selecting existing office parameter IAA_REQUESTED in table OFCVAR, and the CAMA selector.

Office parameter IMEI_ACCEPTABLE_FOR_EMRG_CALL in table OFCVAR provides an option for the network operator to accept emergency call setups from mobile stations that transmit the international mobile equipment identity (IMEI) instead of the international mobile subscriber identity (IMSI) or temporary mobile subscriber identity (TMSI). The default value allows emergency call setups with IMEI as the identifier where, for example, no serial interface module (SIM) is present.

Table size

There is no fixed maximum number of tuples in each subtable, but the maximum number of tuples is 16 382. The number of tuples is allocated dynamically.

Note: The maximum number of tuples can vary due to compression and expansion of tuples.

AMCODE (continued)**Datafill**

The following table lists datafill for table AMCODE.

Field descriptions (Sheet 1 of 2)

Field	Subfield or refinement	Entry	Explanation and action
XLANAME		alphanumeric (1 to 8 characters)	Translation name. Enter the name assigned to subtable AMCODE. The name must be datafilled in table AMHEAD.
NUMDIGS		0 to 30	Number of digits. Enter the number of digits to compare with the actual number of digits dialed.
RELATION		EQ, GE, or LE	Relationship. Enter the relationship that must be satisfied between the actual number of digits dialed and the value in field NUMDIGS. Enter EQ (equal to), GE (greater than), or LE (less than equal to).
XLADATA		see subfield	Translation data. This field consists of subfield XLASEL plus a set of options dependent on the entry in XLASEL.
CONTMARK		+ or \$	Continuation mark. Enter + if additional information for this tuple is contained in the next record. Otherwise, enter \$ to indicate the end of the tuple.
	XLASEL	CONT, DBQ, DMOD, DNRTE, FEAT, FEATINFO, HRC, IAC, NET, RTE, or TRMT	<p>Translation selector.</p> <p>Enter CONT and datafill its refinements if further translation is required.</p> <p>Enter DBQ and datafill its refinements to perform a database query.</p> <p>Enter DMOD and datafill its refinements if the input digit stream requires modification.</p> <p>Enter DNRTE and datafill its refinements if the input digits are routed.</p> <p>Enter FEAT and datafill its refinements if access to a feature is required.</p>

AMCODE (continued)

Field descriptions (Sheet 2 of 2)

Field	Subfield or refinement	Entry	Explanation and action
			<p>Enter FEATINFO and datafill its refinements to trigger the screening function.</p> <p>Enter HRC and enter datafill for its refinements to add the home routing code selector to local number portability applications.</p> <p>Enter IAC and datafill its refinements if the insertion of own area code is required when an ambiguous area code is found through translations.</p> <p>Enter RTE and datafill refinement RTE if a translation result was found, and translation is to terminate.</p> <p>Enter TRMT and datafill refinement TRMT if a call is routed to a treatment.</p>

XLASEL = CONT

This selector is used if further translation is required. The next table to use is given by option XLT. Option CON in the head table entry for the current XLANAME determines whether the digits that were used to index the current table are to be consumed (that is, ignored by the next table). For example, in a pretranslator, the digits are not usually consumed, but they are consumed when continuing from the office code table to table DNINV. The consumed digits are not deleted from the digit register (they are ignored for the moment).

It is possible to datafill the tables so that the same table is explicitly reentered, but it is not recommended because it makes the sequence very difficult to follow and prone to error. (The same table refers to the same subtable in the same translation system. It is correct to enter a different subtable in the same translation system, but if option XLT is not used, this is not the case.) If the same table is entered, it is datafilled explicitly.

If selector CONT is used, option XLT must be present in the code table tuple or in the default options (DFOP) of the corresponding head table. If selector CONT is used in the default tuple (DFLT), option XLT must be present there as well. Selector DMOD does not use the default options from the head table, so option XLT must be datafilled in the code table tuple as well.

AMCODE (continued)

Table AMAXLAID must be datafilled prior to selecting option AMAXLAID.

If the entry in field XLASEL is CONT, datafill the following refinements.

Field descriptions for conditional datafill (Sheet 1 of 14)

Field	Subfield or refinement	Entry	Explanation and action
	OPT	see subfield	Options. This field is a vector consisting of up to ten options. Each option consists of subfield OSEL and refinements that depend on the entry in subfield OSEL. For each option, specify the option selector (OSEL), followed by a space, and the refinements, each separated by a space. The entry is concluded by a \$ and datafill continues with field DFOP.
	OSEL	ACF, AMAXLAID, CALLCTRL, CAMA, CDN, CDNRTE, CHGIND, CLASS, CLIOVRD, CONSUME, CPCRTE, CPMCALL, DDIDX, DEST, EXTCIC, IAA, LNET, MM, MZONE, NETSRV, OSS, PCC, PF, PNRF, PRESEL PRIVL, QFT, SETCDN, TELETAXE, TOC, VPN, or XLT	<p>Option selector. The following options can be selected:</p> <p>Enter ACF, followed by a space, and datafill refinement ACF if the area code fence is defined.</p> <p>Enter AMAXLAID, followed by a space, and datafill refinement XLAID to specify an automatic message accounting (AMA) identity from within table AMAXLAID.</p> <p>Enter CALLCTRL, followed by a space, and datafill refinement CALLCTRL. The entry in refinement CALLCTRL indicates who has control of the call: the calling party, the called party, or both.</p> <p>Enter CAMA, followed by a space, and datafill refinement CLDFMT. The entry in field CLDFMT indicates whether the international centralized automatic message accounting (ICAMA) record is generated with the the originally signaled directory number (DN) or the final public switched telephone network (PSTN) number.</p>

AMCODE (continued)

Field descriptions for conditional datafill (Sheet 2 of 14)

Field	Subfield or refinement	Entry	Explanation and action
			<p>Enter CDN, followed by a space, and datafill refinement CDN to select the nature of address field. This field is used to identify the called party of the initial address message (IAM). It is used for Australian ISDN user part (AISUP) call translations.</p> <p>Enter CDNRTE to route the call using the called number name (CDNNAME) in the CDNCHAR table. If the CDNNAME is present on the incoming call or is set in the SETCDN option, translation proceeds to the CDNUXLA table. The CDNRTE option does not have refinements.</p> <p>Enter CHGIND to indicate whether the value of the charge indicator in the Backward Call Indicators should be overridden.</p> <p>CHGIND indicates whether to override the value of the charge indicator in the Backward Call indicators. The CHGIND option is available only for JCTV loads.</p> <p>Datafill the CHGIND field with the following values:</p> <ul style="list-style-type: none"> • ASIS-treat charge indicator as is • CHG-treat charge indicator as charge • NOCHG-treat charge indicator as no charge <p>Enter CLASS, followed by a space, and datafill refinement CLASS if the class of the dialed digits can be determined.</p> <p>Enter CLIOVRD, followed by a space, and enter datafill for refinement CLIOVRD. This option blocks or allows delivery of a calling line identity (CLI) for each call.</p> <p>Enter CONSUME, followed by a space, and datafill refinement CONDIGS to specify the number of digits that are consumed during translation.</p>

AMCODE (continued)**Field descriptions for conditional datafill (Sheet 3 of 14)**

Field	Subfield or refinement	Entry	Explanation and action
			<p>Enter CPCRTE to route the call using the calling party category (CPCNAME) from table CPCCHAR. If the CPCNAME is present on the incoming call, translation proceeds to table CPCUXLA. The CPCRTE option does not have refinements.</p>
			<p>Enter CPMCALL, followed by a space, and datafill refinement CPMCALL to specify call billing against the called party instead of the calling party for intra-office calls.</p>
			<p>Enter DDIDX, followed by a space, and enter data for refinement DDIDX if a destination discount applies to the call.</p>
			<p>Enter DEST, followed by a space, and datafill refinement DEST if the destination is known.</p>
			<p>Enter EXTCIC, followed by a space, and datafill refinements SOURCE, SKIPDIGS, and CICSIZE. EXTCIC is the external carrier identification code that indicates a long distance carrier in the global environment. This option is only supported for TOPS calls. For further information, refer to functionality Global Competitive Access, GOS00006.</p>
			<p>Enter IAA and the datafill refinement IAA_INDEX to generate or modify IAA message parameters based on datafill in table IAACtrl.</p>
			<p>Enter LNET, followed by a space, and datafill refinement LNET if a logical network is required for metering.</p>
			<p>Enter MM, followed by a space, and datafill refinements MIN and MAX if the minimum and maximum dialed digits are known.</p>
			<p>Enter MZONE, followed by a space, and datafill refinement MZONE if metering is to be done on the call.</p>

AMCODE (continued)**Field descriptions for conditional datafill (Sheet 4 of 14)**

Field	Subfield or refinement	Entry	Explanation and action
			<p>Enter NETSRV and datafill refinement NETSRV_NAME to indicate a Japan network service.</p> <p>Enter OSS. This option does not have refinements.</p> <p>Enter PCC, followed by a space, and datafill refinement PCCDR if a pseudo country code is required.</p> <p>Enter PF, followed by a space, and datafill refinement PFDIGS if there are prefix digits in the digit stream.</p> <p>Enter PNRF to invoke the ported number recognition function. The LNP applications in the German market use this option. The PNRF option does not have refinements.</p> <p>Enter PRESEL, followed by a space, if the call is to be treated as a preselected carrier case.</p> <p>Enter PRIVL, followed by a space, and datafill refinement PRIVL if the user is a privileged user (for example, operators).</p> <p>Enter QFT, followed by OFF or ON to indicate if an outgoing route is capable of QSIG feature transparency.</p> <p>Note: Operating company personnel must not add the QFT option to a route unless the far-end node is QFT-capable.</p> <p>Enter SETCDN, followed by a space, and enter datafill for the CDNNAME refinement. The SETCDN option allows CDN routing when incoming agents are not available in table CDNCHAR.</p> <p>Enter TELETAXE. This option does not have refinements.</p>

AMCODE (continued)**Field descriptions for conditional datafill (Sheet 5 of 14)**

Field	Subfield or refinement	Entry	Explanation and action
			Enter TOC, followed by a space, and datafill refinement CHG for the type of charge if the type of charge messaging is selected.
			Enter VPN, followed by a space, and datafill refinements ONNET and BILLABLE if the call routes through a service switching point (SSP) and feature package NTXH49AA or NTXH49AB (VPN - SSP) is in the switching unit.
			Enter XLT, followed by a space, and datafill refinement XLASYS if the call is to proceed to another translation system.
	ACF	0 to 29	Area code fence. If the entry in subfield OSEL is ACF, datafill this refinement. Enter the number of digits between the beginning of the digits to currently index the table, and the end of the area code.
	BILLABLE	Y or N	Virtual private network billable call. If the entry in subfield OSEL is VPN, datafill this refinement. Enter Y if an AMA record is required for each VPN call. Otherwise, enter N. The system does not generate an AMA record if an address complete message (ACM) of address complete - no charge is returned, or if the call terminates in the SSP on a line with the free number terminating (FNT) option.
	CALLCLASS	PRESELECT OVERRIDE, CSN,TRUNK	Call class. If the entry in subfield OSEL is PRESEL, enter PRESELECT to treat the DN as a preselected call. Enter OVERRIDE to permit the DN to use override codes. Enter CSN to treat the DN as a carrier specific number. Enter TRUNK to permit access to trunk originated calls.

AMCODE (continued)

Field descriptions for conditional datafill (Sheet 6 of 14)

Field	Subfield or refinement	Entry	Explanation and action
	CALLCTRL	CALLED, CALLING, LAST, or MUTUAL	<p>Call control. If the entry in subfield OSEL is CALLCTRL, datafill this refinement. Enter one of the following values to specify the party controlling the call:</p> <ul style="list-style-type: none"> • If the entry is CALLED and the called party goes on-hook first, the call is released immediately. If the calling line goes on-hook first and does not reanswer, the connection is not released until the called line goes on-hook. There are no time-outs, and the calling party is allowed to reanswer until the called line goes on-hook. <p>Calls to lines with option ESG must have CALLCTRL(CALLED).</p> <p>Calls terminating on an International Traffic Operator Position System (ITOPS) must have CALLCTRL (CALLED).</p> <ul style="list-style-type: none"> • If the entry is CALLING and the calling line goes on-hook first, the call is released immediately. If the called line goes on-hook first, the called party is allowed to reanswer within a datafilled reanswer time-out or until the calling line goes on-hook. If the time-out expires or if the calling line goes on-hook, the calling party releases the call and the called party is set to idle. • If the entry is LAST, the call is released when the later of the called party or the calling party goes on-hook. If either party goes on-hook, that party is allowed to reanswer within a datafilled reanswer time-out or until both parties go on-hook. <p>Call control (continued). Enter one of the following values to specify the party controlling the call:</p> <ul style="list-style-type: none"> • If the entry is MUTUAL and either line goes on-hook, the call is released immediately.

AMCODE (continued)**Field descriptions for conditional datafill (Sheet 7 of 14)**

Field	Subfield or refinement	Entry	Explanation and action
	CDNNAME	alphanumeric string	Called number name. If the entry in subfield OSEL is SETCDN, enter data for this refinement. The CDNNAME refinement allows CDN routing when incoming agents are not available in table CDNCHAR.
	CHG	SEND_CHARGE or SEND_NO_CHARGE	Charge. If the entry in subfield OSEL is TOC, datafill this refinement. Enter SEND_CHARGE to set the answer message (BTUP ANM) type of answer (TOA) string sent out from a node to SEND_CHARGE. Enter SEND_NO_CHARGE to set the answer message (BTUP ANM) type of answer (TOA) string sent out from a node to SEND_NO_CHARGE.
	CICSIZE	1 to 4	CIC size. If the entry in subfield OSEL is EXTCIC, datafill this refinement. This field indicates how many digits are in the CIC. This field operates on the B (called) number, so it is assumed that the CIC is signalled as part of the B number. The MAP display indicates the range is 0 to 4; however, the system does not allow 0.

AMCODE (continued)**Field descriptions for conditional datafill (Sheet 8 of 14)**

Field	Subfield or refinement	Entry	Explanation and action
	CLASS	ATT, CNTL, COLL, DATT, EMRG, IAGRP, ICNTL, INTL, IOPRA, LCL, NATL, OPRA, RURAL, SPEC, UNKW, or URBAN	<p>Translation CLASS. If the entry in subfield OSEL is CLASS, datafill this refinement. Enter the translation class determined by the dialed digits, as listed below. (This can be used for screening or billing purposes as described under CLASS in screening and charging options)</p> <ul style="list-style-type: none"> • ATT (attendant console) • CNTL (continental) • COLL (collect) • DATT (dial attendant) • EMRG (emergency) • IAGRP (interagent group) • ICNTL (intercontinental) • INTL (international) • IOPRA (international operator assisted) • LCL (local) • NATL (national) • OPRA (operator assisted) • RURAL (rural) • SPEC (special) • UNKW (unknown) • URBAN (urban)
	CLDFMT	CURRENT or POSTXLA	<p>Called format. If the entry in subfield OSEL is CAMA, enter either CURRENT or POSTXLA to produce the required ICAMA record format.</p> <p>If the entry is CURRENT, the system produces an ICAMA record with the signaled DN (without translation).</p> <p>If the entry is POSTXLA, the system produces an ICAMA record with a public switched telephone network (PSTN) number resulting from translations.</p>

AMCODE (continued)**Field descriptions for conditional datafill (Sheet 9 of 14)**

Field	Subfield or refinement	Entry	Explanation and action
	CLIOVRD	CNB, CNA	Calling line identity override. If the entry in subfield OSEL is CLIOVRD, enter data for this refinement. Enter CNA to allow the CLI for each call. Enter CNB to block the CLI for each call.
	CONDIGS	numeric (0 to 29 digits)	Consumed digits. If the entry in subfield OSEL is CONSUME, datafill this refinement. Enter a number to explicitly define the number of digits consumed during call processing.
	CONTINUE	CONT, NOCONT	Continue. If the entry in subfield OSEL is PRESEL, enter CONT to continue translations through UXLA. Enter NOCONT to immediately route translations through PCIXLA or PCITRK.
	CPMCALL	Y or N	Called party metering. If the entry in subfield OSEL is CPMCALL, datafill this refinement. Enter Y (yes) if calls are billed against the called party for intra-office calls. Enter N (no) for the default value of billing against the calling party for intraoffice calls.
	DDIDX	0 to 63 or DEFAULT	Destination discount index. If the entry in subfield OSEL is DDIDX, enter data for this refinement. Enter the destination discount index number, from table AOCOPT.
	DEST	0 to 1023	Destination route list index. If the entry in subfield OSEL is DEST, datafill this refinement. Enter the number in the route list, of the same translation system, that the call is routed to.
	IAA_INDEX	0 to 1024	Interadministration accounting index. If the entry in subfield OSEL is IAA, datafill this refinement. Enter the value that indexes the corresponding tuple in IAACtrl.

AMCODE (continued)**Field descriptions for conditional datafill (Sheet 10 of 14)**

Field	Subfield or refinement	Entry	Explanation and action
	LNET	alphanumeric (1 to 16 characters)	Logical network. If the entry in subfield OSEL is LNET, datafill this refinement. Enter the logical network name that the call is on. The logical network name must be previously datafilled in table LNETWORK. The entry in this field is used by the international metering system to determine a tariff for the call.
	MAX	0 to 30	Maximum digits. If the entry in subfield OSEL is MM, datafill this refinement. Enter the maximum number of digits expected. This value includes the digits used to index the current tuple and must also include the prefix digits specified in the current tuple.
	MIN	0 to 30	Minimum digits. If the entry in subfield OSEL is MM, datafill this refinement. Enter the minimum number of digits expected. This value includes the digits used to index the current tuple and must also include the prefix digits specified in the current tuple.
	MZONE	0 to 63	Metering zone. If the entry in subfield OSEL is MZONE, datafill this refinement. Enter the metering zone of the call, in the logical network as defined by selector LNET. The entry in this field is used by the international metering system to determine a tariff for the call.

AMCODE (continued)**Field descriptions for conditional datafill (Sheet 11 of 14)**

Field	Subfield or refinement	Entry	Explanation and action
	NETSRV_ NAME	IPHS, DPHS, MOBILE, DA, TELEGRAM, or NCC	<p>Network service name. If the entry in subfield OSEL is NETSRV, datafill this refinement. The entry in this field determines the parameters in an outgoing IAM message.</p> <p>Enter IPHS to indicate a call to an independent personal handyphone system subscriber.</p> <p>Enter DPHS to indicate a call to a dependent personal handyphone system subscriber.</p> <p>Enter MOBILE to indicate a call to a mobile subscriber.</p> <p>Enter DA to indicate a call to the directory assistance operator.</p> <p>Enter TELEGRAM to indicate a call to the Telegram office.</p> <p>Enter NCC to indicate a call routed to one of the following networks:</p> <ul style="list-style-type: none"> • New Common Carrier serving international toll traffic • New Common Carrier serving national toll traffic
	NOA	INTL, LOCAL, NATL or NET	<p>Nature of address. Enter the required called party nature of address as follows:</p> <ul style="list-style-type: none"> • INTL (international) • LOCAL (local) • NATL (national) • NET (Intelligent Network Services)

AMCODE (continued)

Field descriptions for conditional datafill (Sheet 12 of 14)

Field	Subfield or refinement	Entry	Explanation and action
	ONNET	Y or N	<p>Call on virtual private network. If the entry in subfield OSEL is VPN, datafill this refinement. Enter Y if the call stays within the defined virtual private network. Otherwise, enter N.</p> <p>Overlapped outpulsing is only supported on off-network calls. Calls processed without subfield ONNET set to Y are off-network calls. Meridian Digital Centrex (MDC) calls are treated as off-network calls, and therefore overlapped outpulsing is supported for MDC calls.</p>
	PCCDR	0 to 9, B, C, D, E (1 to 3 digits)	<p>Pseudo country code digits. If the entry in subfield OSEL is PCC, datafill this refinement. Enter the three-digit pseudo country code (PCC). If a two-digit PCC is required, it must be padded by a leading zero.</p> <p>The pseudo country code is used to record a particular pseudo country code. This can be extracted for use by system logic later, for example, two-stage outpulsing.</p>
	PFDIGS	0 to 24	<p>Number of prefix digits. If the entry in subfield OSEL is PF, datafill this refinement. Enter the number of prefix digits. If prefix digits are identified in a previous table, this number is added to the existing value. Prefix digits are not used to index any further translation tables and are not outpulsed, but they do remain stored in call detail records (CDR).</p> <p>Note: If refinements PF and CONSUME are both datafilled for the same tuple, only the entry for the greater of the two values is processed; the other entry is ignored.</p>
	PFXAMA	0 to 4 digits, or N	<p>Called party number prefix in AMA. If NOA is set to NTL, datafill PFXAMA with 0011.</p> <p>If NOA is set to NATL, datafill PFXAMA with 0.</p> <p>If NOA is set to LOCAL or NET, datafill PFXAMA with N.</p>

AMCODE (continued)**Field descriptions for conditional datafill (Sheet 13 of 14)**

Field	Subfield or refinement	Entry	Explanation and action
	PRIVL	Y or N	Privileged user. If the entry in subfield OSEL is PRIVL, datafill this refinement. Enter Y (yes), if the user is a privileged user (for example, operator). Otherwise, enter N (no).
	SKIPDIGS	0 to 24	Skip digits. If the entry in subfield OSEL is EXTCIC, datafill this refinement. This field indicates how many digits to skip before extracting the carrier digits from the digit stream. This field operates on the B (called) number, so it is assumed that the CIC is signalled as part of the B number.
	SOURCE	PRESUB or DIALED	Carrier identification code source. If the entry in subfield OSEL is EXTCIC, datafill this refinement. This field specifies the source of the CIC as follows: <ul style="list-style-type: none"> • PRESUB - presubscribed, the CIC is defined in table TRKGRP • DIALED - dialed, the CIC is entered by the subscriber when dialing a call
	STOPRTMR	Y or N	Stop remote timer. Enter Y to disable the address complete message (ACM) timer of the remote switch. Default is N.
	XLAID	FREE, GENERIC1, GENERIC2, or GENERIC3	AMA translation identifier. If the entry in subfield OSEL is AMAXLAID, datafill this refinement. Enter the AMA translation identifier to be used against table AMAXLAID.

AMCODE (continued)

Field descriptions for conditional datafill (Sheet 14 of 14)

Field	Subfield or refinement	Entry	Explanation and action
	XLASYS	AC, AM, CT, FA, FT, NSC, OFC, PX	<p>Translation system. If the entry in subfield OSEL is XLT, datafill this refinement. Enter the next translation system to use, as listed below, followed by a space, then datafill refinement XLANAME:</p> <ul style="list-style-type: none"> • AC (access) • AM (ambiguous) • CT (country) • FA (foreign area) • FT (utility) • NSC (number service code) • OFC (office) • PX (prefix) <p>Note: NIL is not a valid entry. NIL is only used to satisfy internal software functionality. NSC is not used in GL03.</p>
	XLANAME	alphanumeric (1 to 8 characters)	<p>Translation name. If the entry in subfield OSEL is XLT, datafill this refinement. Enter the translation name of the table within the XLASYS to which the call is routed.</p>

AMCODE (continued)**XLASEL = DBQ**

If the entry in field XLASEL is DBQ, datafill the following refinements.

Field descriptions for conditional datafill (Sheet 1 of 2)

Field	Subfield or refinement	Entry	Explanation and action
	OPT	see subfield	Options. This field is a vector consisting of up to ten options. Each option consists of subfield OSEL, and refinements that depend on the entry in subfield OSEL. For each option, specify the option selector (OSEL), followed by a space, then the refinements, each separated by a space. The entry is concluded by a \$ and datafill continues with field DFOP.
	OSEL	MM, NSC, or PF	Option selector. The following options can be selected: Enter MM, followed by a space, and datafill refinements MIN and MAX, if the minimum and maximum dialed digits are known. Enter NSC, followed by a space, and datafill refinement NSCODE, if a number service code operation is to be performed on a call. Enter PF, followed by a space, and datafill refinement PFDIGS if there are prefix digits in the digit stream.
	MAX	0 to 30	Maximum digits. If the entry in subfield OSEL is MM, datafill this refinement. Enter the maximum number of digits expected. This value includes the digits used to index the current tuple and must also include the prefix digits specified in the current tuple.
	MIN	0 to 30	Minimum digits. If the entry in subfield OSEL is MM, datafill this refinement. Enter the minimum number of digits expected. This value includes the digits used to index the current tuple and must also include the prefix digits specified in the current tuple.

AMCODE (continued)

Field descriptions for conditional datafill (Sheet 2 of 2)

Field	Subfield or refinement	Entry	Explanation and action
	NSCODE	AIN, 800P, E008, E800, MAP_HLR, MAP_MSC, MAP_VLR, PVN, MAPHLR, REPLDIGS, or VPN	<p>Number service code. If the entry in subfield OSEL is NSC, enter the required number service code for the operation to be performed on the call, as listed below:</p> <ul style="list-style-type: none"> • AIN (advanced intelligent network) • 800P (800+) • E008 (Enhanced 008) • E800 (Enhanced 800) • MAP_HLR (mobile application part home location register) • MAP_MSC (mobile application part mobile service switching center) • MAP_VLR (mobile application part visitor location register) • MAPHLR (appears only if feature AE1014 [MAP Interworking to BTUP] is on the switch) • PVN (private virtual network) • REPLDIGS (replace digits) • VPN (virtual private network)
	PFDIGS	0 to 24	<p>Number of prefix digits. If the entry in subfield OSEL is PF, datafill this refinement. Enter the number of prefix digits. If prefix digits are identified in a previous table, then this number is added to the existing value. Prefix digits are not used to index any further translation tables and are not outpulsed, but they do remain stored in call detail records (CDR).</p>

AMCODE (continued)**XLASEL = DMOD**

If the entry in subfield XLASEL is DMOD, datafill the following refinements.

Field descriptions for conditional datafill (Sheet 1 of 7)

Field	Subfield or refinement	Entry	Explanation and action
	OPT	see subfield	Options. This field is a vector consisting of up to ten options. Each option consists of subfield OSEL, and refinements that depend on the entry in subfield OSEL. For each option, specify the option selector (OSEL), followed by a space, and the refinements, each separated by a space. The entry is concluded by a \$ and datafill continues with field DFOP.
	OSEL	AFTER, CDNRTE, CGNDM, CONSUME, COODM, CPCRTE, DEL, EXTCIC, INSRT, PF, RBP, REPL, SETCDN, VPNREPL, VPNXLT, or XLT	<p>The following options can be selected:</p> <p>Enter AFTER, followed by a space, and datafill refinement AFTER if a certain number of digits must be skipped before modifying the digit stream.</p> <p>Enter CDNRTE to route the call using the called number name (CDNNAME) from table CDNCHAR. If the CDNNAME is present on the incoming call, or is set by the SETCDN option, translation proceeds to table CDNUXLA. The CDNRTE option does not have refinements.</p> <p>Enter CGNDM, followed by a space, and datafill refinements PREFXCLI and INSRTCLI to remove digits from the calling line identification (CLI) and insert a datafilled digit string of up to five digits in the prefix string. The total length of the CLI and the digit string can be up to 18 digits. A modified CLI and digit string greater than 18 digits routes the call to treatment.</p> <p>Enter CONSUME, followed by a space, and datafill refinement CONDIGS to specify the number of digits that are consumed during translation.</p>

AMCODE (continued)

Field descriptions for conditional datafill (Sheet 2 of 7)

Field	Subfield or refinement	Entry	Explanation and action
			<p>Enter COODM, followed by a space, and datafill refinement SERVICE to replace the dialed emergency code by the emergency number stored in table LAC.</p> <p>Note: Option selector COODM must be combined with option XLT to guarantee that translation continues with the modified number. Selector COODM cannot be combined with any other option.</p> <p>Enter DEL, followed by a space, and datafill refinement DELDIGS. Further digits are accepted from the agent, and overlapped outpulsing is not affected. Digits being deleted are processed before those being inserted.</p> <p>Enter EXTCIC, followed by a space, and datafill refinements SOURCE, SKIPDIGS, and CICSIZE. EXTCIC is the external carrier identification code that indicates a long distance carrier in the global environment. This option is only supported for TOPS calls. For further information, refer to functionality Global Competitive Access, GOS00006.</p> <p>Enter INSRT, followed by a space, and datafill refinement INSRDIGS. Further digits are accepted from the agent, and overlapped outpulsing is not affected. Digits being deleted are processed before those being inserted.</p> <p>Note: Digit insertion is done in the actual digit stream, and the changes are reflected in call detail records. Replacement and insertion cannot be datafilled in the same tuple. If both options are datafilled, the second option in the tuple is used.</p> <p>Enter PF, followed by a space, and datafill refinement PFDIGS, if there are prefix digits in the digit stream.</p>

AMCODE (continued)

Field descriptions for conditional datafill (Sheet 3 of 7)

Field	Subfield or refinement	Entry	Explanation and action
			<p>Enter RBP without refinements. The entry RBP is used when a call is to be marked as Ringback Price. The RBP entry in table ACCODE suffixes a hexadecimal E to the calling digits for a call that translates using a tuple with option RBP.</p> <p>Enter REPL and datafill refinement REPLDIGS. Overlapped outpulsing is disabled, and all digits are collected before continuing.</p> <p>Note: Digit replacement occurs in the actual digit stream, and the changes are reflected in call detail records. Replacement and insertion cannot be datafilled in the same tuple. If both options are datafilled, the second option in the tuple is used.</p> <p>Enter SETCDN, followed by a space, and enter data for refinement CDNNAME. The SETCDN option allows CDN routing when incoming agents are not available in table CDNCHAR.</p> <p>Enter VPNREPL to replace the called party digits with the VPN called party digits conveyed across the public network by the QSIG Feature Transparency mechanism.</p> <p>Enter VPNXLT to replace the current translation system and translator name with the values stored in table BGIDMAP. The entry to table BGIDMAP is addressed by the NNI BGID and SIGNIFICANCE information received in the originating signaling for the call.</p> <p>Enter XLT, followed by a space, and datafill refinement XLASYS if the call proceeds to another translation system.</p>

AMCODE (continued)

Field descriptions for conditional datafill (Sheet 4 of 7)

Field	Subfield or refinement	Entry	Explanation and action
	AFTER	0 to 29	<p>After. If the entry in subfield OSEL is AFTER, datafill this refinement. Enter the number of digits to skip before doing the modification. The default case is to calculate the new prefix fence, and replace, insert, or delete digits after the fence (for example, starting at the next digit). Option AFTER is an additional number of digits to skip before doing the modification. Option AFTER refers to the option datafilled immediately before it. For example,</p> <p>>DMOD DEL 3 AFTER 2 INSRT 11</p> <p>skips two digits, deletes the next three, and inserts digit 11 at the beginning of the digit string. The result when applied to 234567 is 23117.</p> <p>Note: Datafilling this refinement with 0 (the default value), displays the following error message:</p> <pre>Too few digits for AFTER UNSUPPORTED OPTION AT: # PROCESSING ERROR UNEXPECTED ERROR CONDITION</pre>
	CDNNAME	alphanumeric string	<p>Called number name. If the entry in subfield OSEL is SETCDN, enter data for this refinement. The CDNNAME refinement allows CDN routing when incoming agents are not available in table CDNCHAR.</p>
	CICSIZE	1 to 4	<p>CIC size. If the entry in subfield OSEL is EXTCIC, datafill this refinement. This field indicates how many digits are in the CIC. This field operates on the B (called) number, so it is assumed that the CIC is signalled as part of the B number.</p> <p>The MAP display indicates the range is 0 to 4; however, the system does not allow 0.</p>

AMCODE (continued)**Field descriptions for conditional datafill (Sheet 5 of 7)**

Field	Subfield or refinement	Entry	Explanation and action
	CONDIGS	0 to 29	Consumed digits. If the entry in subfield OSEL is CONSUME, datafill this refinement. Enter a number to explicitly define the number of digits consumed during call processing.
	DELDIGS	0 to 29	Delete digits. If the entry in subfield OSEL is DEL, datafill this refinement. Enter the number of digits to be deleted, after skipping digits to be left unprocessed.
	INSRDIGS	numeric (0 to 29 digits)	Insert digits. If the entry in subfield OSEL is INSRT, datafill this refinement. Enter the digits to be inserted, after skipping digits to be left unprocessed.
	INSRTCLI	1 to 5 digits or \$	Insert calling line identification. If the entry in subfield OSEL is CGNDM, datafill this refinement. Enter the new string to insert as the prefix onto the CLI. Enter \$ to specify that no digit string is inserted.
	PFDIGS	0 to 24	Number of prefix digits. If the entry in subfield OSEL is PF, datafill this refinement. Enter the number of prefix digits. If prefix digits are identified in a previous table, this number is added to the existing value. Prefix digits are not used to index any further translation tables and are not outpulsed, but they do remain stored in call detail records (CDR). Note: If refinements PF and CONSUME are both datafilled for the same tuple, only the entry for the greater of the two values is processed; the other entry is ignored.
	PREFXCLI	0 to 18	Prefix calling line identification. If the entry in subfield OSEL is CGNDM, datafill this refinement. Enter the number of prefix digits to delete.
	REPLDIGS	numeric (0 to 30 digits)	Replace digits. If the entry in subfield OSEL is REPL, datafill this refinement. Enter the digits that replace the existing digits, after skipping digits to be left unprocessed.

AMCODE (continued)**Field descriptions for conditional datafill (Sheet 6 of 7)**

Field	Subfield or refinement	Entry	Explanation and action
	SERVICE	alphanumeric (1 to 8 characters)	COODM service. If the entry in subfield OSEL is COODM, datafill this refinement. Enter the emergency service name. Emergency service names are listed in field EMRGSERV in table LAC.
	SKIPDIGS	0 to 24	Skip digits. If the entry in subfield OSEL is EXTCIC, datafill this refinement. This field indicates how many digits to skip before extracting the carrier digits from the digit stream. This field operates on the B (called) number, so it is assumed that the CIC is signalled as part of the B number.
	SOURCE	PRESUB or DIALED	Carrier identification code source. If the entry in subfield OSEL is EXTCIC, datafill this refinement. This field specifies the source of the CIC as follows: <ul style="list-style-type: none"> • PRESUB - presubscribed, the CIC is defined in table TRKGRP • DIALED - dialed, the CIC is entered by the subscriber when dialing a call

AMCODE (continued)**Field descriptions for conditional datafill (Sheet 7 of 7)**

Field	Subfield or refinement	Entry	Explanation and action
	XLASYS	AC, AM, CT, FA, FT, NSC, OFC, or PX	<p>Translation system. If the entry in subfield OSEL is XLT, datafill this refinement. Enter the next translation system to use, followed by a space, and datafill subfield XLANAME (the instance of the translation system).</p> <p>The choice of translation systems is as follows:</p> <ul style="list-style-type: none"> • AC (access) • AM (ambiguous) • CT (country) • FA (foreign area) • FT (utility) • NSC (number service code) • OFC (office) • PX (prefix) <p>Note: NSC is not used in GL03. NIL is not a valid entry. NIL is only used to satisfy internal software functionality.</p>
	XLANAME	alphanumeric (1 to 8 characters)	<p>Translation name. If the entry in subfield OSEL is XLT, datafill this refinement. Enter the translation name of the table within the XLASYS to which the call is routed.</p>

XLASEL = DNRTE

After datafilling table ACHEAD, table DNINV must be datafilled before selector DNRTE is datafilled in table ACCODE.

AMCODE (continued)

Table AMAXLAID must be datafilled prior to selecting option AMAXLAID in field OSEL.

Field descriptions for conditional datafill (Sheet 1 of 4)

Field	Subfield or refinement	Entry	Explanation and action
	OPT	see subfield	Options. This field is a vector consisting of up to ten options. Each option consists of subfield OSEL, and refinements that depend on the entry in subfield OSEL. For each option, specify the option selector (OSEL), followed by a space, and the refinements, each separated by a space. The entry is concluded by a \$ and datafill continues with field DFOP.
	OSEL	ALLOWOVL AMAXLAID, CAMA, CLASS, DN, MM, PF, or SF	<p>Option selector. The following options can be selected:</p> <p>Enter ALLOWOVL to allow overlap.</p> <p>Enter AMAXLAID, followed by a space, and datafill refinement XLAID to specify an automatic message accounting (AMA) identity from within table AMAXLAID.</p> <p>Enter CAMA, followed by a space, and datafill refinement CLDFMT. The entry in CLDFMT indicates whether the international centralized AMA (ICAMA) record is generated with the originally signaled DN or the final public switched telephone network (PSTN) number.</p>

AMCODE (continued)**Field descriptions for conditional datafill (Sheet 2 of 4)**

Field	Subfield or refinement	Entry	Explanation and action
	OSEL (continued)		<p>Enter CLASS, followed by a space, and datafill refinement CLASS if the class of the dialed digits is determined.</p> <p>Enter DN, followed by a space, and datafill refinements SNPA and OFC for the DN that the call is routed to.</p> <p>Enter MM, followed by a space, and datafill refinements MIN and MAX if the minimum and maximum dialed digits are known.</p> <p>Enter PF, followed by a space, and datafill refinement PFDIGS if there are prefix digits in the digit stream.</p> <p>Enter SF, followed by a space, and datafill refinement SFDIGS to indicate the beginning of the station code digits.</p>
	CLDFMT	CURRENT, POSTXLA	<p>Called format. If the entry in subfield OSEL is CAMA, enter either CURRENT or POSTXLA to produce the required ICAMA record format.</p> <p>If the entry is CURRENT, an ICAMA record is produced with the signaled DN (without translation).</p> <p>If the entry is POSTXLA, an ICAMA record is produced with the public switched telephone network (PSTN) number resulting from translations.</p>

AMCODE (continued)

Field descriptions for conditional datafill (Sheet 3 of 4)

Field	Subfield or refinement	Entry	Explanation and action
	CLASS	ATT, CNTL, COLL DATT, EMRG, IAGRP, ICNTL, INTL, IOPRA, LCL, NATL, OPRA, RURAL, SPEC, UNKW, or URBAN	<p>Translation class. If the entry in subfield OSEL is CLASS, datafill this refinement. Enter the translation class determined by the dialed digits. This can be used for screening or billing purposes as described under CLASS in screening and charging options.</p> <ul style="list-style-type: none"> • ATT (attendant console) • CNTL (continental) • COLL (collect) • DATT (dial attendant) • EMRG (emergency) • IAGRP (interagent group) • ICNTL (intercontinental) • INTL (international) • IOPRA (international operator assisted) • LCL (local) • NATL (national) • OPRA (operator assisted) • RURAL (rural) • SPEC (special) • UNKW (unknown) • URBAN (urban)
	MAX	0 to 30	<p>Maximum digits. If the entry in subfield OSEL is MM, datafill this refinement. Enter the maximum number of digits expected. This value includes the digits used to index the current tuple and must also include the prefix digits specified in the current tuple.</p>
	MIN	0 to 30	<p>Minimum digits. If the entry in subfield OSEL is MM, datafill this refinement. Enter the minimum number of digits expected. This value includes the digits used to index the current tuple and must also include the prefix digits specified in the current tuple.</p>

AMCODE (continued)**Field descriptions for conditional datafill (Sheet 4 of 4)**

Field	Subfield or refinement	Entry	Explanation and action
	OFC	numeric (1 to 7 digits)	Seven-digit office code. If the entry in subfield OSEL is DN, enter the office code for the DN that the call is routed to.
	PFDIGS	0 to 24	Number of prefix digits. If the entry in subfield OSEL is PF, datafill this refinement. Enter the number of prefix digits. If prefix digits are identified in a previous table, this number is added to the existing value. Prefix digits are not used to index any further translation tables and are not outpulsed, but they do remain stored in call detail records (CDR).
	SFDIGS	0 to 29	Station fence digits. If the entry in subfield OSEL is SF, datafill this refinement. Enter a number to indicate how many digits to advance past the start of the digits that index into the tuple. If option SF is not datafilled, the last four digits comprise the station code. During call processing, the station code digits consist of all digits beyond this indicator to the end of the dialled digits.
	SNPA	000 to 999 (3 digits)	Serving number plan area. If the entry in subfield OSEL is DN, enter the required serving number plan area (SNPA). This number must be datafilled in table HNPACONT or in table SNPANAME.
	XLAID	FREE, GENERIC1, GENERIC2, or GENERIC3	AMA translation identifier. If the entry in subfield OSEL is AMAXLAID, enter the AMA translation identifier to be used against table AMAXLAID.

AMCODE (continued)

XLASEL = FEAT

If the entry in field XLASEL is FEAT, datafill the following refinements.

Field descriptions for conditional datafill (Sheet 1 of 3)

Field	Subfield or refinement	Entry	Explanation and action
	OPT	see subfield	Options. This field is a vector consisting of up to ten options. Each option consists of subfield OSEL, and refinements that depend on the entry in subfield OSEL. For each option, specify the option selector (OSEL), followed by a space, and the refinements, each separated by a space. The entry is concluded by a \$ and datafill continues with field DFOP.
	OSEL	FTR, FUNC, MM, or PF	<p>Option selector. The following options can be selected:</p> <p>Enter FTR, followed by a space, and datafill refinement FTR to identify the international line feature.</p> <p>Enter FUNC, followed by a space, and datafill refinement FUNC to identify the international line feature function.</p> <p>Enter MM, followed by a space, and datafill refinements MIN and MAX if the minimum and maximum dialed digits are known.</p> <p>Enter PF, followed by a space, and datafill refinement PFDIGS if there are prefix digits in the digit stream.</p>

AMCODE (continued)**Field descriptions for conditional datafill (Sheet 2 of 3)**

Field	Subfield or refinement	Entry	Explanation and action
	FTR	CALLBACK, CALLCHAR, CLCTDIGS, JES, NTC, TLC, VMWI, VSC or VALIDATE	<p>Feature name. If the entry in subfield OSEL is FTR, enter the refinement name shown below:</p> <ul style="list-style-type: none"> • CALLBACK (call back) • CALLCHAR (call characters) • CLCTDIGS (collect digits) • JES (Japan emergency services) • NTC (Notify Time Charges) • TLC (trunk logic circuit) • VMWI (voice mail waiting indication) • VSC (vertical service code) • VALIDATE (not used in GL03)
	FUNC	ACT, DEACT, DELETE, INTER, PROG, or USAGE	<p>Feature function code. If subfield OSEL is set to FUNC, enter one of the international line feature function codes listed below:</p> <ul style="list-style-type: none"> • ACT (activate) • DEACT (deactive) • DELETE (delete) • INTER (interrogate) • PROG (programming) • USAGE (usage)
	MAX	0 to 30	<p>Maximum digits. If the entry in subfield OSEL is MM, datafill this refinement. Enter the maximum number of digits expected following MIN entry and a space. This value includes the digits used to index the current tuple and must also include the prefix digits specified in the current tuple.</p>

AMCODE (continued)

Field descriptions for conditional datafill (Sheet 3 of 3)

Field	Subfield or refinement	Entry	Explanation and action
	MIN	0 to 30	Minimum digits. If the entry in subfield OSEL is MM, datafill this refinement. Enter the minimum number of digits expected. This value includes the digits used to index the current tuple and must also include the prefix digits specified in the current tuple.
	PFDIGS	0 to 24	Number of prefix digits . If the entry in subfield OSEL is PF, datafill this refinement. Enter the number of prefix digits. If prefix digits are identified in a previous table, this number is added to the existing value. Prefix digits are not used to index any further translation tables and are not outputted, but they remain stored in call detail records (CDR).

XLASEL = FEATINFO

If the entry in subfield XLASEL is FEATINFO, datafill the following refinements. Selector FEATINFO makes use of table DNSCRN to store information against DNs, which is used during call processing to determine how to proceed with the call. The screening function is triggered by selector FEATINFO in the universal translation tables. The options available with this selector are shown below.

Field descriptions for conditional datafill (Sheet 1 of 10)

Field	Subfield or refinement	Entry	Explanation and action
	FTR	CALLBACK, CALLCHAR, CLCTDIGS, JES, NTC, TLC, or VALIDATE	Feature name. Enter CALLBACK to enable originator callback during translations. Datafill subfield CALLBACK_OPTION and its refinements, then datafill subfields PFDIGS, MINDIGS, MAXDIGS, and TABREF. Enter CALLCHAR to modify all signaling characteristics. Datafill subfields CLLCHROP, PFDIGS, MINDIGS, MAXDIGS, and TABREF.

AMCODE (continued)**Field descriptions for conditional datafill (Sheet 2 of 10)**

Field	Subfield or refinement	Entry	Explanation and action
			<p>Enter CLCTDIGS to collect digits from the call originator and add them to the called digits stream for translation. Datafill subfields CLDGMIN, CLDGMAX, CLCTDIGS_OPTION, PFDIGS, MINDIGS, MAXDIGS, and TABREF.</p> <p>Enter JES to activate the Japan Emergency Service feature. Datafill refinements PFDIGS and TABREF.</p> <p>Enter NTC to notify the originating subscriber of applicable time and charges after the call terminates. Datafill subfield SUBOPT_NAME and its refinement, then datafill subfields PFDIGS, MINDIGS, MAXDIGS, and TABREF.</p> <p>Enter TLC to enable the test line call feature, which provides audible ringback tone followed by dial tone after specified durations. Datafill subfields RING_BACK_TONE_DUR, DIAL_TONE_DUR, TLC_PREFIX_DIGS, TLC_NUM_DIGS, and TLC_CHARGE.</p> <p>Enter VALIDATE, and datafill subfield VALDATOP and its refinements. Datafill subfields PFDIGS, MINDIGS, MAXDIGS, and TABREF.</p>
	CALLBACK_OPTION	CLCTDEST or NIL	<p>Callback option. If the entry in field FTR is CALLBACK, datafill this option. Enter CLCTDEST to call back the subscriber and collect destination digits. Datafill subfields CLDGMIN, CLDGMAX, DISC_ANNC_TRK, PROMPT_ANNC_TRK, and SEND_ANM. Otherwise, enter NIL.</p>
	CLDGMIN	1 to 24	<p>Minimum collected digits. Enter the minimum number of digits to be collected and entered into the called digit stream.</p>

AMCODE (continued)**Field descriptions for conditional datafill (Sheet 3 of 10)**

Field	Subfield or refinement	Entry	Explanation and action
	CLDGMAX	1 to 24	Maximum collected digits. Enter maximum number of digits to be collected and written into the called digit stream. The value cannot be less than CLDGMIN.
	DISC_ANNC_TRK	alphanumeric (1 to 16 characters)	Disconnect announcement trunk. Enter trunk common language location identifier (CLLI).
	PROMPT_ANNC_TRK	alphanumeric (1 to 16 characters)	Prompt announcement trunk. Enter trunk the common language location identifier (CLLI).
	SEND_ANM	Y or N	Send answer message. Enter Y (yes) or N (no).
	CLLCHROP	NOCHGMSG or EARLYCPG	Call characteristics. If the entry in field FTR is CALLCHAR, datafill this option. Enter NOCHGMSG to block backward CHG message. Enter EARLYCPG to specify that a call progress (CPG) message is issued in the backwards direction before an address complete message (ACM) is sent. The CPG message is permitted before an ACM in certain ISDN user part (ISUP) variants to establish a bidirectional speech path and to stop the T7 timer.
	CLCTDIGS_OPTION	NIL or \$	Collect digits option. If the entry in field FTR is CLCTDIGS, datafill this option. Enter NIL or enter \$ to proceed to the next option.
	SUBOPT_NAME	DUR_ADJ	Suboption name. If the entry in field FTR is NTC, datafill this option. Enter DUR_ADJ to specify the duration adjustment for NTC and datafill subfield DURATION_ADJ.
	DURATION_ADJ	0 to 99	Duration adjustment. Enter the time in seconds.

AMCODE (continued)**Field descriptions for conditional datafill (Sheet 4 of 10)**

Field	Subfield or refinement	Entry	Explanation and action
	RING_BACK_TONE_DUR	1 to 255	Ringback tone duration. If the entry in field FTR is TLC, datafill this option. Enter the time, in seconds, that ringback tone is provided to the originator.
	DIAL_TONE_DUR	1 to 255	Dial tone duration. If the entry in field FTR is TLC, datafill this option. Enter the time, in seconds, that dial tone is provided to the originator.
	TLC_PREFIX_DIGS	0 to 18	Prefix digits in called number. If the entry in field FTR is TLC, datafill this option. Enter the number of digits to advance the prefix fence to detect the charge message digits when CPC = PAYPHONE.
	TLC_NUM_DIGS	numeric (3 or 4) Japan only	Test line call number of digits. Enter the number of dialed digits to be transferred to the NCCI#7 CHG message. This is also the number of digits stored in the LMNNUM field of the SMDR #DE record.
	TLC_CHARGE	Y or N	Test line call charge indicator. The TLC_CHARGE field indicates the billing status of an ISUP test call. Enter Y if the call is billable. Enter N if the call is not billable. The default value for this field is N.
	OPT	see subfield VALDATOP	Options. If the entry in field FTR is VALIDATE, datafill this option. This field is a vector consisting of up to five options. Each option consists of subfield VALDATOP, and refinements that depend on the entry in subfield VALDATOP. For each option, specify VALDATOP, followed by a space, then the refinements, each separated by a space. The entry is concluded by a \$ and datafill continues with field DFOP.

AMCODE (continued)

Field descriptions for conditional datafill (Sheet 5 of 10)

Field	Subfield or refinement	Entry	Explanation and action
	VALDATOP	BCSCRN, CALLED, CLDTCOLG, CLISERV, CUSTMOD, LCASCRN, NOCHARGE, PRESEL, SCRNLNTH, SUBSCRN, TCNOTSCR, THIRDPTY, VERDEST, V3PTYBIL	<p>Validate option. Enter a list of up to five options. The options specify what characteristics are to be considered when screening the call. Enter \$ to signify the end of the list.</p> <p>Note: Selector VALIDATE is traversed only once for each call.</p> <p>Enter BCSCRN and datafill refinement BCOPTS to identify the bearer capability name.</p> <p>Enter CALLED to indicate the number to be used for screening. The SUBSCRN options are used to specify the subscriber types allowed to receive the call.</p> <p>Note: When using option CALLED, there must be no further digit manipulation after selector VALIDATE is encountered in translations.</p> <p>If option CALLED is not entered, then the calling party number is used for screening and the SUBSCRN options are used to specify the subscriber types allowed to make the call.</p> <p>Note: Pay phone subscribers are treated as general subscribers if option CALLED is specified.</p> <p>Enter CLDTCOLG, followed by a space, to copy digits from the called to the calling digit stream, and datafill options OFFSET and COUNT.</p> <p>Enter CLISERV, followed by a space, and enter data in subfield SERVNAME to add the name of the service provider.</p>

AMCODE (continued)

Field descriptions for conditional datafill (Sheet 6 of 10)

Field	Subfield or refinement	Entry	Explanation and action
			<p>Enter CUSTMOD, followed by a space, to alter the internal network class of service (NCOS) and customer group to new value for a given directory number (DN) based on the CUSTINFO attribute in table DNSCRN. The source of the DN used as an index into table DNSCRN is determined by the VALIDATE datafill. Datafill refinement CUSTSCRN.</p> <p>Enter LCASCRN, followed by a space, to enable local calling area screening. The called and calling numbers are checked against tables LCARNAME and LCASCRN to determine if the numbers are local to each other, and whether the call should be denied or allowed to continue routing.</p> <p>Enter NOCHARGE, followed by a space, to indicate that the call is nonbillable.</p> <p>Note: If both NOCHARGE and THIRDPTY options are specified, NOCHARGE takes precedence.</p> <p>Enter PRESEL to allow screening for the PRESEL attribute in table DNSCRN.</p> <p>Enter SCRNLNTH, followed by a space, and datafill refinement MINLNTH to specify the minimum length of the number being screened.</p> <p>Enter SUBSCRN, followed by a space, and datafill up to three multiples of the following subscriber types: GENERAL, PAYPHONE, PERSONAL, and MOBILE. Enter \$ after entering SUBSCRN to indicate that no subscriber types are permitted to make or receive the call.</p> <p>Enter TCNOTSCR to indicate that calls with CPC set to Test Call are not screened.</p>

AMCODE (continued)

Field descriptions for conditional datafill (Sheet 7 of 10)

Field	Subfield or refinement	Entry	Explanation and action
			<p>Enter THIRDPY to indicate that automatic third party billing is used. Table DNSCRN is checked for attribute UNPAID.</p> <p>Note: If both NOCHARGE and THIRDPY options are specified, NOCHARGE takes precedence.</p> <p>Note: Payphone subscribers are treated as general subscribers if option CALLED is specified.</p> <p>Enter VERDEST to verify the destination of a call. Called digits are checked against ADDCODE entries in table DNSCRN.</p> <p>Note: NIL appears on the switch range but is not a valid entry. The value NIL is used only to satisfy internal software requirements.</p>
	BCOPTS	alphanumeric (1 to 8 characters)	Bearer capability option. If the entry in field VALDATOP is CLDTCOLG, enter subfield count to count the digits from the called stream to the calling stream.
	COUNT	0 to 30	If the entry in field VALDATOP is BCSCRN, enter data for this refinement. Enter a maximum of four bearer capability names.
	CUSTSCRN	Y or N	<p>Customer screen. Enter Y to block calls that are not subscribed to the switched on-net services if attempting a switched on-net call. If the DN being screened is not present in table DNSCRN, the call is rejected with the Call Not Allowed (CNAD) treatment. The internal NCOS and CUSTGRP associated with the call are altered to the values found in the CUSTINFO attribute if present for the given DN in table DNSCRN. The DN used to index table DNSCRN can be the subscriber calling line identification (CLI) or the dialed number. The source of the DN is determined by the datafill of field VALIDATE.</p> <p>Enter N if no screening is performed.</p>

AMCODE (continued)**Field descriptions for conditional datafill (Sheet 8 of 10)**

Field	Subfield or refinement	Entry	Explanation and action
Note: The FEATINFO values CCANN, CCARD, CCSDT, DAFOP, FAXSUP, FAXTEST, INBFAX, INBFD, INTLFD, ISD, ISDTST, ISDVRE, OUTBFAX, OUTBFD, PB3RDPTY, PBCALL, PBISD, PBISDVRE, and PBTST are valid only in DMS-250 switching offices. Additional DMS-250 parameters are listed in the DMS-250 specific data schema NTPs.			
	MINLNTH	0 to 18 values from 0 to 30 are possible in APC software loads	Minimum length. If the entry in field VALDATOP is SCRNLNTH, enter the minimum number of digits required in number being screened.
	OFFSET	0 to 30	If the entry in field VALDATOP is CLDTCOLG, enter data in subfield OFFSET to offset the digits from the called stream to the calling stream.
	SERVNAME	alphanumeric string	Service provider name. If the entry in field VALDATOP is CLISERV, enter the name of the service provider in this refinement.
	SUBSCTYP	GENERAL, PAYPHONE, PERSONAL, or MOBILE	Subscriber type. Enter subscriber type, followed by a space, and datafill refinements WHITLIST, CHKBLKCL, CHKUNPD, and CHKCCR. This option allows you to specify which subscriber types are permitted to make or receive a call and whether the subscriber's standing is important for a call.
	WHITLIST	Y or N	Whether it list. Enter Y (yes) to indicate that the subscriber's directory number must be datafilled in table DNSCRN. Otherwise, enter N (no).
	CHKBLKCL	Y or N	Check block call. Enter Y to check if the subscriber has subscribed to all services for which this tuple is being used (BLKCALL attribute in table DNSCRN). Otherwise, enter N.
	CHKUNPD	Y or N	Check unpaid. Enter Y to check if the subscriber has paid his bills. Otherwise, enter N.

AMCODE (continued)**Field descriptions for conditional datafill (Sheet 9 of 10)**

Field	Subfield or refinement	Entry	Explanation and action
	CHKCCR	Y or N	Check cumulative call restriction. Enter Y to check the subscriber's cumulative charge limit. Otherwise, enter N.
	PFDIGS	0 to 24	Prefix digits. Enter the number of prefix digits present at this point in the call. Prefix digits are not used to index any further translation tables and are not outpulsed, but they remain stored in call detail records (CDR).
	MINDIGS	0 to 30	Minimum digits. Enter the minimum number of digits expected. This value includes the digits used to index the current tuple and must also include the prefix digits specified in the current tuple.
	MAXDIGS	0 to 30	Maximum digits. Enter the maximum number of digits expected. This value includes the digits used to index the current tuple and must also include the prefix digits specified in the current tuple.
	TABREF	see subfields	Table reference. This field consists of subfields XLASYS and XLANAME.

AMCODE (continued)**Field descriptions for conditional datafill (Sheet 10 of 10)**

Field	Subfield or refinement	Entry	Explanation and action
	XLASYS	AC, AM, CT, FA, FT, NSC, OFC, or PX	<p>Translation system. Enter the next translation system to use, followed by a space, and datafill subfield XLANAME (the instance of the translation system).</p> <p>The choice of translation systems is as follows:</p> <ul style="list-style-type: none"> • AC (access) • AM (ambiguous) • CT (country) • FA (foreign area) • FT (utility) • NSC (number service code) • OFC (office) • PX (prefix) <p>Note: NIL is not a valid entry. NIL is used only to satisfy internal software functionality.</p>
	XLANAME	alphanumeric (1 to 8 characters)	Translation name. Enter the translation name of the table instance within the XLASYS to which the call is routed.

XLASEL = HRC

If the entry in subfield XLASEL is HRC, datafill the following refinements.

Field descriptions for conditional datafill (Sheet 1 of 2)

Field	Subfield	Entry	Explanation and action
	OPT	see subfield	Options. This field contains subfield OSEL, and refinements that depend on the entry in subfield OSEL. The entry is concluded by a \$ and datafill continues with field DFOP.
	OSEL	XLT, PFBILL	Option selector. If the call proceeds to another translation system, enter XLT, followed by a space, and datafill refinement XLASYS. Also complete an entry for option selector PFBILL.

AMCODE (continued)**Field descriptions for conditional datafill (Sheet 2 of 2)**

Field	Subfield	Entry	Explanation and action
	XLASYS	AC, AM, CT, FA, FT, NSC, OFC, PX	<p>Translation system. If option selector XLT is entered in subfield OSEL, datafill this refinement. Enter the next translation system to use, followed by a space, then datafill refinement XLANAME. Enter one of the following:</p> <ul style="list-style-type: none"> • AC (access) • AM (ambiguous) • CT (country) • FA (foreign area) • FT (utility) • NSC (number service code) • OFC (office) • PX (prefix) <p>Note: NIL is not a valid entry. NIL is used only to satisfy internal software functionality. NSC is not used in GL03.</p>
	XLANAME	alphanumeric (1 to 8 characters)	Translation name. If XLT is entered in subfield OSEL, datafill this refinement. Enter the translation name of the table within the XLASYS to which the call is routed.
	PFBILL	Y or N	Prefix billing option. Enter PFBILL, followed by a space, and then enter either Y or N. If Y is entered, the home routing code specified in the tuple is included in the billing record. If N is entered, the home routing code is not included in billing records.

AMCODE (continued)**XLASEL = IAC**

If the entry in subfield XLASEL is IAC, datafill the following refinements.

Field descriptions for conditional datafill

Field	Subfield or refinement	Entry	Explanation and action
	OPT	see subfield	Options. This field is a vector list consisting of up to ten options. Each option consists of subfield OSEL, and refinements that depend on the entry in subfield OSEL. The entry is concluded by a \$ and datafill continues with field DFOP.
	OSEL	PF	Option selector. Enter PF, followed by a space, and datafill refinement PFDIGS, if there are prefix digits in the digit stream.
	PFDIGS	0 to 24	Number of prefix digits. If the entry in subfield OSEL is PF, datafill this refinement. Enter the number of prefix digits. If prefix digits are identified in a previous table, then this number is added to the existing value. Prefix digits are not used to index any further translation tables and are not outputted, but they remain stored in call detail records (CDR).

XLASEL = RTE

If the entry in subfield XLASEL is RTE, datafill the following refinements.

AMCODE (continued)

Table AMAXLAID must be datafilled prior to selecting option AMAXLAID in field OSEL.

Field descriptions for conditional datafill (Sheet 1 of 13)

Field	Subfield or refinement	Entry	Explanation and action
	OPT	see subfield	Options. This field is a vector consisting of up to ten options. Each option consists of subfield OSEL, and refinements that depend on the entry in subfield OSEL. For each option, specify the option selector (OSEL), followed by a space, and the refinements, each separated by a space. The entry is concluded by a \$ and datafill continues with field DFOP.
	OSEL	ACF, AMAXLAID, BLKOVLP, CALLCTRL, CAMA, CDN, CDNRTE, CLASS, CONSUME, CPCRTE, CPMCALL, DDIDX, DEST, EXTCIC, IAA, LNET, MM, MZONE, NETSRV, PCC, PF, PIP, PNRF, PRESEL, PRESELRTE, PRIVL, SETCDN, TELETAXE, TOC, or VPN	<p>Option selector. The following options can be selected:</p> <p>Enter ACF, followed by a space, and datafill refinement ACF, if the area code fence is defined.</p> <p>Enter AMAXLAID, followed by a space, and datafill refinement XLAID, to specify an automatic message accounting (AMA) identity from within table AMAXLAID.</p> <p>Enter BLKOVLP to prevent the system from outpulsing calls until all CDN digits are collected. The BLKOVLP option does not have refinements.</p> <p>Enter CALLCTRL, followed by a space, and datafill refinement CALLCTRL. The entry in refinement CALLCTRL indicates who has control of the call: the calling party, the called party, or both.</p> <p>Enter CAMA, followed by a space, and datafill refinement CLDFMT. The entry in refinement CLDFMT indicates whether the international centralized automatic message accounting (ICAMA) record is generated with either the originally signaled directory number (DN) or the final public switched telephone network (PSTN) number.</p>

AMCODE (continued)**Field descriptions for conditional datafill (Sheet 2 of 13)**

Field	Subfield or refinement	Entry	Explanation and action
			<p>Enter CDN, followed by a space, and datafill refinement CDN to select the nature of address field. This field is used to identify the called party of the initial address message (IAM). It is used for Australian ISDN user part (AISUP) call translations.</p> <p>Enter CDNRTE to route a call using the called number name (CDNNAME) from table CDNCHAR. If the CDNNAME is present on the incoming call or is set by the SETCDN option, translation proceeds to table CDNUXLA. The CDNRTE option does not have refinements.</p> <p>Enter CLASS, followed by a space, and datafill refinement CLASS, if the class of the dialed digits is determined.</p> <p>Enter CONSUME, followed by a space, and datafill refinement CONDIGS, to specify the number of digits that are consumed during translation.</p> <p>Enter CPRTE to route a call using the calling party category (CPCNAME) from table CDNCHAR. If the CPCNAME is present on the incoming call, translation proceeds to table CPCUXLA. The CPRTE option does not have refinements.</p> <p>Enter CPMCALL, followed by a space, and datafill refinement CPMCALL, to specify call billing against the called party instead of the calling party for intraoffice calls.</p> <p>Enter DDIDX, followed by a space, and enter data for refinement DDIDX if a destination discount applies.</p> <p>Enter DEST, followed by a space, and enter data for refinement DEST if the call destination is known.</p>

AMCODE (continued)

Field descriptions for conditional datafill (Sheet 3 of 13)

Field	Subfield or refinement	Entry	Explanation and action
			<p>Enter EXTCIC, followed by a space, and datafill refinements SOURCE, SKIPDIGS, and CICSIZE. EXTCIC is the external carrier identification code that indicates a long distance carrier in the global environment. This option is only supported for TOPS calls. For further information, refer to functionality Global Competitive Access, GOS00006.</p> <p>Enter IAA and the datafill refinement IAA_INDEX to generate or modify IAA message parameters based on datafill in table IAACtrl.</p> <p>Enter MM, followed by a space, and enter data for refinements MIN and MAX. Enter this subfield if the minimum and maximum number of expected digits dialed are known. These values include the digits used to index the current tuple and must also include the prefix digits specified in the current tuple.</p> <p>Note: For fast interdigital timing to function properly, MM can only be used with the RTE selector when the value in refinement MIN is not equal to the value in MAX. In other words, if MIN=MAX, MM can be used with the CONT selector in table PXCOD. If the value in refinement MIN is not equal to the value in refinement MAX, MM cannot be used until the RTE selector is used. If refinements MIN and MAX are set in table PXCOD when they are not equal to each other, partial dial timing is used after MIN digits are dialed to determine the end of dialing.</p> <p>Enter MZONE, followed by a space, and datafill refinement MZONE, if metering is done on the call.</p> <p>Enter NETSRV and datafill refinement NETSRV_NAME to indicate a Japan network service.</p>

AMCODE (continued)**Field descriptions for conditional datafill (Sheet 4 of 13)**

Field	Subfield or refinement	Entry	Explanation and action
			<p>Enter PCC, followed by a space, and datafill refinement PCCDR, if a pseudo country code is required.</p> <p>Enter PF, followed by a space, and datafill refinement PFDIGS, the prefix fence. This is the number of prefix digits associated with this tuple. That is, if some prefix digits were identified in a previous table, the number here is added to the existing value. Prefix digits are not used to index any further translation tables and are not outpulsed, but they remain stored in call detail records (CDR).</p> <p>Enter PIP to perform a residency check for the digits being translated. The local number portability feature uses the residency check to make sure that calls to DNs which have been ported in to the office are not routed out of the office. The PIP option does not have refinements.</p> <p>Enter PNRF to invoke the ported number recognition function, which LNP applications in Germany use. The PNRF option does not have refinements.</p> <p>Enter PRESEL, followed by a space, if the call is to be treated as a preselected carrier case.</p> <p>Enter PRESELRTE, followed by a space, and datafill refinement PRESELRTE, the index into the route table of the current XLASYS and XLANAME.</p>

AMCODE (continued)**Field descriptions for conditional datafill (Sheet 5 of 13)**

Field	Subfield or refinement	Entry	Explanation and action
			<p>Enter PRIVL, followed by a space, and datafill refinement PRIVL, if the user is a privileged user (for example, operators).</p> <p>Enter SETCDN, followed by a space, and enter data for the CDNNAME refinement. This option assigns the called number name (CDNNAME) from table CDNCHAR to the call.</p> <p>Enter TELETAXE. This option does not have refinements.</p> <p>Enter TOC, followed by a space, and datafill refinement CHG for the type of charge where the type of charge messaging is to be selected.</p> <p>Enter VPN, followed by a space, and datafill refinements ONNET and BILLABLE if the call routes through a service switching point (SSP) and feature package NTXH49AA or NTXH49AB (VPN-SSP) is in the switching unit.</p>
	ACF	0 to 29	<p>Area code fence. If the entry in subfield OSEL is ACF, datafill this refinement. Enter the number of digits between the beginning of the digits to currently index the table, and the end of the area code.</p>
	BILLABLE	Y or N	<p>Virtual private network billable call. If the entry in subfield OSEL is VPN, enter Y if an automatic message accounting (AMA) record is required for each VPN call. Otherwise, enter N.</p> <p>An AMA record is not generated if an address complete message (ACM) of address complete, no charge is returned, or if the call terminates in the SSP on a line with the free number terminating (FNT) option.</p>

AMCODE (continued)

Field descriptions for conditional datafill (Sheet 6 of 13)

Field	Subfield or refinement	Entry	Explanation and action
	CALLCLASS	PRESELECT OVERRIDE, CSN,TRUNK	Call class. If the entry in subfield OSEL is PRESEL, enter PRESELECT to treat the DN as a preselected call. Enter OVERRIDE to permit the DN to use override codes. Enter CSN to treat the DN as a carrier specific number. Enter TRUNK to permit access to trunk originated calls.

AMCODE (continued)**Field descriptions for conditional datafill (Sheet 7 of 13)**

Field	Subfield or refinement	Entry	Explanation and action
	CALLCTRL	CALLED, CALLING, LAST, or MUTUAL	<p>Call control. If the entry in subfield OSEL is CALLCTRL, datafill this refinement. Enter one of the following values to specify the party controlling the call:</p> <ul style="list-style-type: none"> • If the entry is CALLED and the called line goes on-hook first, the call is released immediately. If the calling line goes on-hook first and does not reanswer, the connection is not released until the called line goes on-hook. There are no time-outs, and the calling party is allowed to reanswer until the called line goes on-hook. Calls to lines with option ESG must have CALLCTRL(CALLED). Calls terminating on an ITOPS position must have CALLCTRL(CALLED). • If the entry is CALLING and the calling line goes on-hook first, the call is released immediately. If the called line goes on-hook first, the called party is allowed to reanswer within a datafilled reanswer time-out or until the calling line goes on-hook. If the time-out expires or if the calling line goes on-hook, the calling party releases the call and the called line is set to idle. • If the entry is LAST, the call is released when the later of the called party or the calling party goes on-hook. If either party goes on-hook, that party is allowed to reanswer within a datafilled reanswer time-out or until both parties go on-hook. • If the entry is MUTUAL and either line goes on-hook, the call is released immediately.
	CDNNAME	alphanumeric string	<p>Called number name. If the entry in subfield OSEL is SETCDN, enter data for refinement CDNNAME to assign the CDNNAME from table CDNCHAR.</p>

AMCODE (continued)**Field descriptions for conditional datafill (Sheet 8 of 13)**

Field	Subfield or refinement	Entry	Explanation and action
	CHG	SEND_ CHARGE or SEND_NO_ CHARGE	Charge. If the entry in subfield OSEL is TOC, enter SEND_CHARGE to set the answer message (BTUP ANM) type of answer (TOA) string sent out from a node to SEND_CHARGE. Enter SEND_NO_CHARGE to set the answer message (BTUP ANM) type of answer (TOA) string sent out from a node to SEND_NO_CHARGE.
	CICSIZE	1 to 4	CIC size. If the entry in subfield OSEL is EXTCIC, datafill this refinement. This field indicates how many digits are in the CIC. This field operates on the B (called) number, so it is assumed that the CIC is signalled as part of the B number. The MAP display indicates the range is 0 to 4; however, the system does not allow 0.
	CLDFMT	CURRENT POSTXLA	Called format. If the entry in subfield OSEL is CAMA, enter either CURRENT or POSTXLA to produce the required ICAMA record format. If the entry is CURRENT, an ICAMA record is produced with the signaled DN (without translation). If the entry is POSTXLA, an ICAMA record is produced with a PSTN number resulting from translations.

AMCODE (continued)

Field descriptions for conditional datafill (Sheet 9 of 13)

Field	Subfield or refinement	Entry	Explanation and action
	CLASS	ATT, CNTL, COLL, DATT, EMRG, IAGRP, ICNTL, INTL, IOPRA, LCL, NATL, OPRA, RURAL, SPEC, UNKW, or URBAN	<p>Translation class. If the entry in subfield OSEL is CLASS, enter the translation class determined by the dialed digits. This can be used for screening or billing as described under CLASS in screening and charging options.</p> <p>The translation classes are defined as follows:</p> <ul style="list-style-type: none"> • ATT (attendant console) • CNTL (continental) • COLL (collect) • DATT (dial attendant) • EMRG (emergency) • IAGRP (interagent group) • ICNTL (intercontinental) • INTL (international) • IOPRA (international operator assisted) • LCL (local) • NATL (national) • OPRA (operator assisted) • RURAL (rural) • SPEC (special) • UNKW (unknown) • URBAN (urban)
	CONDIGS	0 to 29	<p>Consumed digits. If the entry in subfield OSEL is CONSUME, datafill this refinement. Enter a number to explicitly define the number of digits consumed during call processing.</p>
	CONTINUE	CONT, NOCONT	<p>Continue. If the entry in subfield OSEL is PRESEL, enter CONT to continue translations through UXLA. Enter NOCONT to immediately route translations through PCIXLA or PCITRK.</p>

AMCODE (continued)**Field descriptions for conditional datafill (Sheet 10 of 13)**

Field	Subfield or refinement	Entry	Explanation and action
	CPMCALL	Y or N	Called party metering. If the entry in subfield OSEL is CPMCALL, enter Y (yes) if calls are billed against the called party for intraoffice calls. Enter N (no) for the default value of billing against the calling party for intraoffice calls.
	DDIDX	0 to 63 or DEFAULT	Destination discount index. If the entry in subfield OSEL is DDIDX, enter data for refinement DDIDX if a destination discount applies to the call.
	DEST	0 to 1023	Destination route list index. If the entry in subfield OSEL is DEST, enter the number in the route list, of the same translation system, that the call is routed to.
	IAA_INDEX	0 to 1024	Interadministration accounting index. If the entry in subfield OSEL is IAA, datafill this refinement. Enter the value that indexes the corresponding tuple in IAACRRL.
	LNET	alphanumeric (1 to 16 characters)	Logical network. If the entry in subfield OSEL is LNET, enter the logical network name that the call is on. The logical network name must be previously datafilled in table LNETWORK. The entry in this field is used by the international metering system to determine a tariff for the call.
	MAX	0 to 30	Maximum digits. If the entry in subfield OSEL is MM, datafill this refinement. Enter the maximum number of digits expected. This value includes the digits used to index the current tuple and must also include the prefix digits specified in the current tuple.
	MIN	0 to 30	Minimum digits. If the entry in subfield OSEL is MM, datafill this refinement. Enter the minimum number of digits expected. This value includes the digits used to index the current tuple and must also include the prefix digits specified in the current tuple.

AMCODE (continued)

Field descriptions for conditional datafill (Sheet 11 of 13)

Field	Subfield or refinement	Entry	Explanation and action
	MZONE	0 to 63	Metering zone. The entry in this field is used by the international metering system to determine a tariff for the call. If the entry in subfield OSEL is MZONE, enter the metering zone of the call, in the logical network as defined by selector LNET.
	NETSRV_NAME	IPHS, DPHS, MOBILE, DA, TELEGRAM, or NCC	<p>Network service name. If the entry in subfield OSEL is NETSRV, datafill this refinement. The entry in this field determines the parameters in an outgoing IAM message.</p> <p>Enter IPHS to indicate a call to an independent personal handyphone system subscriber.</p> <p>Enter DPHS to indicate a call to a dependent personal handyphone system subscriber.</p> <p>Enter MOBILE to indicate a call to a mobile subscriber.</p> <p>Enter DA to indicate a call to the directory assistance operator.</p> <p>Enter TELEGRAM to indicate a call to the Telegram office.</p> <p>Enter NCC to indicate a call routed to one of the following networks:</p> <ul style="list-style-type: none"> • New Common Carrier serving international toll traffic • New Common Carrier serving national toll traffic
	NOA	INTL, LOCAL, NATL, or NET	<p>Nature of address. Enter the required called party nature of address.</p> <ul style="list-style-type: none"> • INTL (international) • LOCAL (local) • NATL (national) • NET (Intelligent Network Services)

AMCODE (continued)**Field descriptions for conditional datafill (Sheet 12 of 13)**

Field	Subfield or refinement	Entry	Explanation and action
	ONNET	Y or N	<p>Call on virtual private network. If the entry in subfield OSEL is VPN, enter Y if the call stays within the defined virtual private network. Otherwise enter N.</p> <p>Overlapped outpulsing is only supported on off-network calls. Calls processed without subfield ONNET set to Y are off-network calls. Meridian Digital Centrex (MDC) calls are treated as off-network calls, and therefore overlapped outpulsing is supported for MDC calls.</p>
	PCCDR	0 to 9, B, C, D, E (1 to 3 digits)	<p>Pseudo country code digits. If the entry in subfield OSEL is PCC, enter the three-digit pseudo country code (PCC). If a two-digit PCC is required, it must be padded by a leading zero.</p> <p>The pseudo country code is used to record a particular pseudo country code. This can be extracted for use by system logic later, for example, two-stage outpulsing.</p>
	PFDIGS	0 to 24	<p>Number of prefix digits. If the entry in subfield OSEL is PF, datafill this refinement. Enter the number of prefix digits. If prefix digits are identified in a previous table, this number is added to the existing value. Prefix digits are not used to index any further translation tables and are not outpulsed, but they remain stored in call detail records (CDR).</p> <p>Note: If refinements PF and CONSUME are both datafilled for the same tuple, only the entry for the greater of the two values is processed; the other entry is ignored.</p>
	PFXAMA	0 to 4 digits, or N	<p>Called party number prefix in AMA. If NOA is set to NTL, datafill PFXAMA with 0011.</p> <p>If NOA is set to NATL, datafill PFXAMA with 0.</p> <p>If NOA is set to LOCAL or NET, datafill PFXAMA with N.</p>

AMCODE (continued)**Field descriptions for conditional datafill (Sheet 13 of 13)**

Field	Subfield or refinement	Entry	Explanation and action
	PRIVL	Y or N	Privileged user. If the entry in subfield OSEL is PRIVL, enter Y (yes), if the user is a privileged user (for example, operator). Otherwise, enter N (no).
	SKIPDIGS	0 to 24	Skip digits. If the entry in subfield OSEL is EXTCIC, datafill this refinement. This field indicates how many digits to skip before extracting the carrier digits from the digit stream. This field operates on the B (called) number, so it is assumed that the CIC is signalled as part of the B number.
	SOURCE	PRESUB or DIALED	Carrier identification code source. If the entry in subfield OSEL is EXTCIC, datafill this refinement. This field specifies the source of the CIC as follows: <ul style="list-style-type: none"> • PRESUB - presubscribed, the CIC is defined in table TRKGRP • DIALED - dialed, the CIC is entered by the subscriber when dialing a call
	STOPRTMR	Y or N	Stop remote timer. Enter Y (yes) to disable the address complete message (ACM) timer of the remote switch. Default is N (no).
	XLAID	FREE, GENERIC1, GENERIC2, or GENERIC3	AMA translation identifier. If the entry in subfield OSEL is AMAXLAID, enter the AMA translation identifier to be used against table AMAXLAID.

XLASEL = TRMT

If the entry in subfield XLASEL is TRMT, datafill the following refinements.

AMCODE (continued)

Route to the specified treatment. A treatment is a known exception or failure condition. The action taken terminates translation, returning an indication that a treatment was encountered and decoded into a route.

Field descriptions for conditional datafill

Field	Subfield or refinement	Entry	Explanation and action
	OPT	see subfield	Options. This field is a vector consisting of up to ten options. Each option consists of subfield OSEL, and refinements that depend on the entry in subfield OSEL. For each option, specify the option selector (OSEL), followed by a space, and the refinements, each separated by a space. The entry is concluded by a \$ and datafill continues with field DFOP.
	OSEL	OFC	Option selector. Enter OFC, followed by a space, and datafill refinement OFC, if a treatment name is required.
	OFC	alphanumeric (1 to 4 characters)	Office treatment. Enter a treatment name that is contained in the office treatment subtable, TMTCNTL.TREAT.

Datafill example

An example of datafill for table AMCODE and related tables is shown below.

The example shows the datafill for the office code subtable, OFC234, that references ambiguous code subtable AM234. The dialed digits are 234-727-1364.

Since more digits were dialed than for a local call, the route is changed. Default options apply with selector RTE, so the default options are taken from table OFCHEAD tuple with XLANAME OFC234. The destination reference given in table AMCODE tuple applies to the fourth route list in subtable OFC234 of table OFCRTE. Note that CLASS NATL and DEST 4 in table AMCODE override CLASS LCL and DEST 2 in table OFCCODE. If desired, as shown here, the ambiguous code table can be referred to, after a destination is found if it can change depending on the number of digits dialed.

If no ambiguous code tuple is selected, the entry in field DFLT from tuple AM234 in table AMHEAD is used.

AMCODE (continued)

Although the table AMCODE result indicates that there are eight or more digits, the call is routed to destination 4, option MM in table OFCHEAD directs that a maximum of ten digits are allowed. Option MM takes precedence over the ambiguous code table results. If more than ten digits are dialed, the call is not routed. Note that care must be taken that the values do not conflict, but rather that MM provides a boundary for the ambiguous code results.

MAP display example for table OFCHEAD

XLANAME	DFLT
CON MAXIDX	DFOP
<hr/>	
OFC234	SDFLT
DFOP (MM 6 10) \$	
NOCON 9	

MAP display example for table OFCCODE

XLANAME	FROMD	TOD	XLADATA
<hr/>			
OFC234	234	235	
CONT (XLT AM AM234) (DEST 2) (CLASS LCL) \$			

MAP display example for table OFCRTE

XLANAME	RTEREF	RTELIST
<hr/>		
OFC234	2	(N LOCALCLLI DEL 3 PFXDIGS 09)\$
OFC234	4	(S NEXTOWN)\$

AMCODE (continued)**MAP display example for table AMHEAD**

XLANAME	DFLT
AM234	SDFLT

MAP display example for table AMCODE

XLANAME	NUMDIGS	RELATION	XLADATA
AM234	8	GE	
RTE (DEST 4) (CLASS NATL) \$			

Table history**APC010**

Added field TLC_CHARGE to option TLC in the FEATINFO selector.

LET010

Added option EXTCIC to selectors CONT, DMOD, and RTE.

APC009.1

Added station ringer test (SRT) information.

APC009

Added option NETSRV to selectors CONT and RTE.

Added option JES to selector FEATINFO.

GL04

New entries were added to the XLADATA field.

AMCODE (continued)

APC008.1

The following updates were introduced in APC008.1 to table AMHEAD:

- Field CHKCCR was added to all subscriber types (SUBSCTYP) that are part of the SUBSCRN option of selector FEATINFO VALIDATE.
- Field EARLYCPG was added to selector FEATINFO.
- Option IAA was added to selectors ROUTE and CONT.

GL03

The following updates were introduced in GL03 to table AMCODE:

- provided the ability to datafill ACF in RTE and CONT selectors
- provided the ability to datafill CAMA in RTE, CONT, and DNRTE selectors
- added URBAN to selector CLASS
- applied effectivity to GL03 specific sections

GL004

Added new OSEL options.

APC008

The following updates were introduced in APC008 to table AMCODE:

- option TRUNK was added to field CALLCLASS of option PRESEL of selector RTE
- option TRUNK was added to field CALLCLASS of option PRESEL of selector CONT
- option PRESEL was added to field VALDATOP in selector FEATINFO

APC007

The following updates were introduced in APC07 to table AMCODE:

- option PRESEL was added to selector RTE
- option PRESEL was added to selector CONT

AMCODE (continued)

NA005

The following updates were introduced in NA005 to table AMCODE:

- increased the number for universal translations support to 30 digits, affecting the following options, subfields or selectors:
 - ACF
 - AFTER
 - CONSUME
 - DEL
 - DMOD
 - DNRTE
 - INSRT
 - MAX
 - MIN
 - PF
 - REPL
- added option SF and its refinement to selector DNRTE
- added note about potential conflict with refinements CONSUME and PFDIGS

APC006

PERSONAL subscriber type added to SUBSCRN option of FEATINFO VALIDATE.

APC004

Features CALLBACK, CALLCHAR, CLCTDIGS, NTC, and TLC were added to the FTR field of selector FEATINFO.

Options CLDTCCLG, LCASCRN, TCNOTSCR, VERDEST, and V3PTYBIL were added to the VALDATOP subfield of selector FEATINFO.

Subfield CDN of selectors CONT and RTE was modified to incorporate subfields NOA, STOPRTMR, and PFXAMA.

BCS36

Option CUSTMOD was added to refinement VALDATOP for XLASEL = FEATINFO.

AMCODE (end)

BCS35

The following information was added:

- PRDFXCLI
- INSRTCLI
- value BCSCRN to field VALDATOP
- a general note on restrictions of use of VALIDATE
- field CONSUME
- CPMCALL to XLASEL CONT, RTE

AMHEAD

Table name

Ambiguous Code Head

Functional description

Tables AMHEAD and AMCODE form the ambiguous code translations system in the universal translations system. These tables are used when it is necessary to know the total number of digits dialed if that total affects the outcome of translation.

The tables are divided into subtables, which each translate one ambiguous code. Each subtable is defined by one tuple in table AMHEAD. Table AMCODE has any number of tuples, but usually two. The first field of each AMCODE tuple is the name of the subtable to which it belongs. The next fields of table AMCODE are fields NUMDIGS and RELATION, followed by translations data consisting of a translation selector and options. Table AMCODE is keyed at the MMI (man-machine interface) level by the subtable name and field NUMDIGS.

A tuple is selected from table AMCODE by comparing the total number of digits dialed (excluding prefix digits) with the value of field NUMDIGS. If the relationship of the number of digits to field NUMDIGS is as specified in field RELATION, the correct tuple has been found. For example, if field NUMDIGS has a value of 8 and field RELATION is EQUAL (EQ), that tuple is selected only if eight digits are dialed. If no tuple relation is satisfied in subtable AMCODE, the default tuple from table AMHEAD is used.

The ambiguous code translations system can be referenced from any subtable UXLA by using translation selector CONT or DMOD with option XLT. Subfield XLASYS is AM and field XLANAME is a user-defined subtable name that is datafilled in table AMHEAD. The resultant tuple is interpreted in the context of the previous subtable, the one that references it. Any default options are taken from field DFOP of the xxHEAD table of the previous translation system, and if a destination is set in table AMHEAD or table AMCODE, it refers to the route table (xxRTE) of the previous translations system. If the previous xxCODE table gives a value to an option and table AMCODE resets the value, the value in table AMCODE is used because it was set later, on the basis of additional information.

Note: If selector CONT is used in the ambiguous code table, the next table to be entered can be found in a number of places. First, it can be datafilled (with option XLT) into the xxCODE table tuple. If not there, it can come from the default options (DFOP) of the previous xxHEAD table. As described in table ACHEAD, whether translation continues or goes into an

AMHEAD (continued)

endless loop depends on whether option CON or NOCON in the previous xxHEAD table has been set. If selector DMOD is used, option XLT must be datafilled into the AMCODE tuple, because default options do not apply.

Table AMHEAD is used to define value XLANAME (translation name) and default if a tuple is not found in table AMCODE with the same XLANAME.

Position in outgoing digit stream

The area code fence (ACF) option, available in field OSEL, is used to indicate that an area code is in the digit string. Associated with this option is field ACF, which contains the digit count. This digit count indicates the number of digits between the beginning of the digits used to currently index the table and the end of the area code.

Option ACF is applicable to translation selectors CONT and RTE.

When a KC (or KE = 13) forward connection control signal is sent forward on an outgoing MFC trunk, option ACF is used to determine where the signal is placed in the outgoing stream.

The length of an area code in China is based on the following algorithm:

- If the first digit is 1, then the length of the area code is one digit.
- If the first digit is 2, then the length of the area code is two digits.
- If the first digit is 3 to 9 and the second digit is odd, then the length of the area code is three digits.
- If the first digit is 3 to 9 and the second digit is even, then the length of the area code is four digits.

Note: If an entry is deleted from an xxHEAD table, all xxCODE table entries with the given value XLANAME are deleted. However, all XLT option references to the deleted XLANAME in other tables must be removed manually. If references to a deleted XLANAME are not removed, translations cannot continue when it reaches the missing reference and a call dump occurs.

Datafill sequence and implications

There is no requirement to datafill other tables prior to table AMHEAD.

If the translation selector DBQ is used, table NSCDEFS must be datafilled before table AMHEAD.

AMHEAD (continued)

If the optional selector CGNDM is used with translation selector DMOD, the default Calling Line Identification (CLI) must be datafilled in table TRKSGRP. Different default CLIs can be datafilled on requirements.

Optional selector CGNDM must also be datafilled in table ACCODE to activate the feature.

For option selector CAMA (used in translation selectors CONT and RTE), set office parameter ICAMA_REQUESTED in table OFCVAR to Y (yes) when ICAMA detailed call recording is required.

An IAA record can be generated by selecting office parameter IAA_REQUESTED in table OFCVAR and selector CAMA.

Office parameter IMEI_ACCEPTABLE_FOR_EMRG_CALL in table OFCVAR provides an option for the network operator to accept emergency call setups from mobile stations that transmit the international mobile equipment identifier (IMEI) instead of the international mobile subscriber identifier (IMSI) or temporary mobile subscriber identifier (TMSI). The default value allows emergency call setups with IMEI as the identifier if, for example no serial interface module (SIM) is present.

Only automatic number identification (ANI) and international metered (MTR) trunk group originations currently support the option selector CAMA. All other call types ignore this translation option.

For emergency calls translation, class EMRG has to be datafilled. This can be done before or after translation selector DMOD with option selector COODM. This requirement differentiates between normal mobile originated calls and emergency calls set up by a conventional SETUP message.

Table size

The size of table AMHEAD varies from 0 to 2047 tuples.

Memory is dynamically allocated.

AMHEAD (continued)**Datafill**

The following table lists datafill for table AMHEAD.

Field descriptions (Sheet 1 of 3)

Field	Subfield or refinement	Entry	Explanation and action
XLANAME		alphanumeric (1 to 8 characters)	Translation name. Enter the name assigned to the ambiguous code subtable. There are no restrictions on the name, but it makes the tables more readable if the name contains the ambiguous code that is being translated. For example, ambiguous code 292 could be translated in subtable AM292.
CONTMARK		+	Continuation mark. Enter + to indicate that additional information for this tuple is contained in the next record.
DFLT		see subfield	Default translations data. This is the result that translations uses if the dialed digits are not datafilled in the ACCODE table associated with table ACHEAD. This field consists of subfield DFLTSEL and refinements dependent on the entry in field DFLTSEL.
	DFLTSEL	DFLT or SDFLT	Default selector. Enter DFLT and datafill refinement XLASEL if the standard default is not correct. Enter SDFLT, if a standard default is required for dialed digits not found in the ACCODE table. The standard default is TRMT OFC VACT. That is, if dialed digits are not found in ACCODE, the call is routed to vacant code treatment. No additional datafill is required.
	XLASEL	CONT, DBQ, DMOD, DNRTE, FEAT, FEATINFO, HRC, IAC, RTE, or TRMT	Translations selector.

AMHEAD (continued)**Field descriptions (Sheet 2 of 3)**

Field	Subfield or refinement	Entry	Explanation and action
			Enter CONT and datafill refinement CONT if further translation is required.
			Enter DBQ and datafill refinement DBQ to perform a database query.
			Enter DMOD and datafill refinement DMOD if input digit stream modification is required.
			Enter DNRTE and datafill refinement DNRTE if input digit routing is required.
			Enter FEAT and datafill refinement FEAT if access to a feature is required.
			Enter FEATINFO and datafill refinement FEATINFO to trigger the screening function.
			Enter HRC and enter data for its refinements if the home routing code selector is required for local number portability applications.
			Enter IAC and datafill refinement IAC if the insertion of own area code is required when an ambiguous area code is found through translations.
			Enter RTE and datafill refinement RTE if a translation result was found, and translation is to terminate.

AMHEAD (continued)

Field descriptions (Sheet 3 of 3)

Field	Subfield or refinement	Entry	Explanation and action
	DFOP	DFOP or NODFOP	<p>Enter TRMT and datafill refinement TRMT if a call is routed to a treatment.</p> <p>Default options. Enter DFOP and datafill subfield OSEL and its refinements.</p> <p>The default options only apply if a tuple with field XLASEL set to RTE or CONT is chosen in xxCODE table.</p> <p>If the entry in field DFOP is DFOP, this field is a vector that consists of a number of options. Each option consists of subfield OSEL and refinements dependent on the entry in subfield OSEL. The various refinements are identical to the refinements described in field DFLT, selector CONT, subfield OSEL.</p> <p>For each option, specify the option selector, followed by a space, and the refinements, with each refinement separated from the next by a space. The entry is concluded by a \$ and datafill continues with field CON.</p> <p>Enter NODFOP if there are no default options and datafill field CON.</p>

XLASEL = CONT

If the entry in field XLASEL is CONT, datafill the following refinements.

AMHEAD (continued)

Table AMAXLAID must be datafilled prior to selecting option AMAXLAID in field OSEL.

Field descriptions for conditional datafill (Sheet 1 of 14)

Field	Subfield or refinement	Entry	Explanation and action
	OPT	see subfield	Options. This field is a vector consisting of up to ten options. Each option consists of subfield OSEL and refinements that depend on the entry in subfield OSEL. For each option, specify the option selector (OSEL), followed by a space, and the refinements, each separated by a space. The entry is concluded by a \$ and datafill continues with field DFOP.
	OSEL	ACF, AMAXLAID, CALLCTRL, CAMA, CDN, CDNRTE, CHGIND, CLASS, CLIOVRD, CONSUME, CPCRTE, CPMCALL, DDIDX, DEST, EXTCIC, IAA, LNET, MM, MZONE, NETSRV, OSS, PCC, PF, PNRF, PRESEL, PRIVL, QFT, SETCDN, TELETAXE, TOC, VPN, or XLT	<p>Option selector. The following options can be selected:</p> <p>Enter ACF, followed by a space, and datafill refinement ACF if the area code fence is defined.</p> <p>Enter AMAXLAID, followed by a space, and datafill refinement XLAID to specify an automatic message accounting (AMA) identity from within table AMAXLAID.</p> <p>Enter CALLCTRL, followed by a space, and datafill refinement CALLCTRL. The entry in refinement CALLCTRL indicates who has control of the call: the calling party, the called party, or both.</p> <p>Enter CAMA, followed by a space, and datafill refinement CLDFMT. The entry in field CLDFMT indicates whether the international centralized automatic message accounting (ICAMA) record is generated with the the originally signaled directory number (DN) or the final public switched telephone network (PSTN) number.</p>

AMHEAD (continued)**Field descriptions for conditional datafill (Sheet 2 of 14)**

Field	Subfield or refinement	Entry	Explanation and action
			<p>Enter CDN, followed by a space, and datafill refinement CDN to select the nature of address field. This field is used to identify the called party of the initial address message (IAM). It is used for Australian ISDN user part (AISUP) call translations.</p> <p>Enter CDNRTE to route using the called number name (CDNNAME) from table CDNCHAR. If the CDNNAME is present on the incoming call or is set by the SETCDN option, translation proceeds to table CDNUXLA.</p> <p>Enter CHGIND, followed by a space and datafill refinement CHGIND to override the charge indicator value received from an incoming trunk message. This entry is specific to JCTV.</p> <p>Enter CLASS, followed by a space, and datafill refinement CLASS if the class of the dialed digits can be determined.</p> <p>Enter CLIOVRD, followed by a space, and enter data for refinement CLIOVRD. This subfield indicates calling line identity override.</p> <p>Enter CONSUME, followed by a space, and datafill refinement CONDIGS to specify the number of digits that are consumed during translation.</p> <p>Enter CPC RTE to route using the calling party category (CPCNAME) from table CPCCHAR. If the CPCNAME is present on the incoming call, translation proceeds to table CPCUXLA.</p> <p>Enter CPMCALL, followed by a space, and datafill refinement CPMCALL to specify call billing against the called party instead of the calling party for intra-office calls.</p>

AMHEAD (continued)**Field descriptions for conditional datafill (Sheet 3 of 14)**

Field	Subfield or refinement	Entry	Explanation and action
			Enter DDIDX, followed by a space, and enter data for refinement DDIDX. Enter data for this subfield for the destination discount index.
			Enter DEST, followed by a space, and datafill refinement DEST if the destination is known.
			Enter EXTCIC, followed by a space, and enter data for refinements CICSIZE, SKIPDIGS, or SOURCE. Enter EXTCIC for the external carrier identification code
			Enter IAA and the datafill refinement IAA_INDEX to generate or modify IAA message parameters based on datafill in table IAACtrl.
			Enter LNET, followed by a space, and datafill refinement LNET if a logical network is required for metering.
			Enter MM, followed by a space, and datafill refinements MIN and MAX if the minimum and maximum dialed digits are known.
			Enter MZONE, followed by a space, and datafill refinement MZONE if metering is to be done on the call.
			Enter NETSRV and datafill refinement NETSRV_NAME to indicate a Japan network service.
			Enter OSS for the operator signaling service. The OSS subfield does not have refinements.
			Enter PCC, followed by a space, and datafill refinement PCCDR if a pseudo country code is required.
			Enter PF, followed by a space, and datafill refinement PFDIGS if there are prefix digits in the digit stream.

AMHEAD (continued)

Field descriptions for conditional datafill (Sheet 4 of 14)

Field	Subfield or refinement	Entry	Explanation and action
			<p>Enter PNRF to invoke the ported number recognition function, which is used for LNP applications in Germany. The PNRF option does not require any subfields.</p> <p>Enter PRESEL and datafill refinement PRESEL to provide the necessary information used to index into the PCIXLA table.</p> <p>Enter PRIVL, followed by a space, and datafill refinement PRIVL if the user is a privileged user (for example, operators).</p> <p>Enter QFT followed by ON or OFF to indicate if an outgoing route is capable of QSIG Feature Transparency.</p> <p>Note: The QFT ON option must not be added to a route unless the far-end node is QFT-capable.</p> <p>Enter SETCDN to trigger the setting of outgoing called party characteristics. This option assigns the called number name (CDNNAME) from table CDNCHAR to the call. If the CDNRTE option is subsequently encountered, the CDNNAME is used to route the call.</p> <p>You can use the SETCDN option to allow CDN routing when incoming agents such as DPNSS or BTUP are not available in table CDNCHAR.</p> <p>Enter TELETAXE. This subfield does not have refinements.</p>

AMHEAD (continued)

Field descriptions for conditional datafill (Sheet 5 of 14)

Field	Subfield or refinement	Entry	Explanation and action
			<p>Enter TOC, followed by a space, and datafill refinement CHG for the type of charge if the type of charge messaging is selected.</p> <p>Enter VPN, followed by a space, and datafill refinements ONNET and BILLABLE if the call routes through a service switching point (SSP) and feature package NTXH49AA or NTXH49AB (VPN - SSP) is in the switching unit.</p> <p>Enter XLT, followed by a space, and datafill refinement XLASYS if the call is to proceed to another translation system.</p>
	ACF	0 to 29	Area code fence. If the entry in subfield OSEL is ACF, datafill this refinement. Enter the number of digits between the beginning of the digits to currently index the table, and the end of the area code.
	BILLABLE	Y or N	Virtual private network billable call. If the entry in subfield OSEL is VPN, datafill this refinement. Enter Y if an AMA record is required for each VPN call. Otherwise, enter N. An AMA record is not generated if an address complete message (ACM) of address complete - no charge is returned, or if the call terminates in the SSP on a line with the free number terminating (FNT) option.
		PRESELECT OVERRIDE, CSN, or TRUNK	<p>Preselection call processing. If the entry in subfield OSEL is PRESEL, datafill this refinement. Enter the preselection call class type that is associated with the call.</p> <p>Note: Calltype CSN and TRUNK are available under the PRESEL option. These call classes are not needed for German Carrier Selection, and are not supported. The same applies to the Continue option of CONT. For the German market only, NOCONT is supported.</p>

AMHEAD (continued)

Field descriptions for conditional datafill (Sheet 6 of 14)

Field	Subfield or refinement	Entry	Explanation and action
	CALLCTRL	CALLED, CALLING, LAST, or MUTUAL	<p>Call control. If the entry in subfield OSEL is CALLCTRL, datafill this refinement. Enter one of the following values to specify the party controlling the call:</p> <ul style="list-style-type: none"> If the entry is CALLED and the called party goes on-hook first, the call is released immediately. If the calling line goes on-hook first and does not reanswer, the connection is not released until the called line goes on-hook. There are no time-outs, and the calling party is allowed to reanswer until the called line goes on-hook. <p>Calls to lines with option ESG must have CALLCTRL(CALLED).</p> <p>Calls terminating on an International Traffic Operator Position System (ITOPS) must have CALLCTRL (CALLED).</p>
	CALLCTRL (continued)		<p>Call control (continued). Enter one of the following values to specify the party controlling the call:</p> <ul style="list-style-type: none"> If the entry is CALLING and the calling line goes on-hook first, the call is released immediately. If the called line goes on-hook first, the called party is allowed to reanswer within a datafilled reanswer time-out or until the calling line goes on-hook. If the time-out expires or if the calling line goes on-hook, the calling party releases the call and the called party is set to idle. If the entry is LAST, the call is released when the later of the called party or the calling party goes on-hook. If either party goes on-hook, that party is allowed to reanswer within a datafilled reanswer time-out or until both parties go on-hook. If the entry is MUTUAL and either line goes on-hook, the call is released immediately.

AMHEAD (continued)**Field descriptions for conditional datafill (Sheet 7 of 14)**

Field	Subfield or refinement	Entry	Explanation and action
	CDNNAME	alphanumeric string	If the entry in subfield OSEL is SETCDN, enter data for refinement CDNNAME. Enter CDNNAME to route the call using a called number name from table CDNCHAR.
	CHG	SEND_CHARGE or SEND_NO_CHARGE	Charge. If the entry in subfield OSEL is TOC, datafill this refinement. Enter SEND_CHARGE to set the answer message (BTUP ANM) type of answer (TOA) string sent out from a node to SEND_CHARGE. Enter SEND_NO_CHARGE to set the answer message (BTUP ANM) type of answer (TOA) string sent out from a node to SEND_NO_CHARGE.
	CHGIND	ASIS, CHG, or NOCHG	<p>CHGIND indicates whether to override the value of the charge indicator in the Backward Call indicators. The CHGIND option only applies to JCTV loads.</p> <p>Datafill the CHGIND field with the following values:</p> <ul style="list-style-type: none"> • ASIS-treat charge indicator as is • CHG-treat charge indicator as charge • NOCHG-treat charge indicator as no charge
	CICSIZE	1 to 4	<p>CIC size. If the entry in subfield OSEL is EXTCIC, enter data for this refinement. This field indicates the number of digits in the CIC. This field operates on the B (called) number, so it is assumed that the switch signals the CIC as part of the B number.</p> <p>The MAP display indicates the range is 0 to 4. The system does not allow a 0 entry.</p>

AMHEAD (continued)

Field descriptions for conditional datafill (Sheet 8 of 14)

Field	Subfield or refinement	Entry	Explanation and action
	CLASS	ATT, CNTL, COLL, DATT, EMRG, IAGRP, ICNTL, INTL, IOPRA, LCL, NATL, OPRA, RURAL, SPEC, UNKW, or URBAN	<p>Translation CLASS. If the entry in subfield OSEL is CLASS, datafill this refinement. Enter the translation class determined by the dialed digits, as listed below. (This can be used for screening or billing purposes as described under CLASS in screening and charging options.)</p> <ul style="list-style-type: none"> • ATT (attendant console) • CNTL (continental) • COLL (collect) • DATT (dial attendant) • EMRG (emergency) • IAGRP (interagent group) • ICNTL (intercontinental) • INTL (international) • IOPRA (international operator assisted) • LCL (local) • NATL (national) • OPRA (operator assisted) • RURAL (rural) • SPEC (special) • UNKW (unknown) • URBAN (urban)
	CLDFMT	CURRENT or POSTXLA	<p>Called format. If the entry in subfield OSEL is CAMA, enter either CURRENT or POSTXLA to produce the required ICAMA record format.</p> <p>If the entry is CURRENT, an ICAMA record is produced with the signaled DN (without translation).</p> <p>If the entry is POSTXLA, an ICAMA record is produced with a public switched telephone network (PSTN) number resulting from translations.</p>

AMHEAD (continued)**Field descriptions for conditional datafill (Sheet 9 of 14)**

Field	Subfield or refinement	Entry	Explanation and action
	CLIOVRD	CNA, CNB	Calling line identity override. If the entry in subfield OSEL is CLIOVRD, enter data for this refinement. Enter CNA to allow the calling number for each call. Enter CNB to block the calling number for each call.
	CONDIGS	numeric (0 to 29 digits)	Consumed digits. If the entry in subfield OSEL is CONSUME, datafill this refinement. Enter a number to explicitly define the number of digits consumed during call processing.
	CONTINUE	CONT, NOCONT	Continue. If the entry in subfield OSEL is PRESEL, enter data for this refinement. Enter CONT to continue translations through UXLA. Enter NOCONT to route translations through PCIXLA or PCITRK.
	CPMCALL	Y or N	Called party metering. If the entry in subfield OSEL is CPMCALL, datafill this refinement. Enter Y (yes) if calls are billed against the called party for intra-office calls. Enter N (no) for the default value of billing against the calling party for intraoffice calls.
	DDIDX	1 to 63 or DEFAULT	Destination discount index. If the entry in subfield OSEL is DDIDX, enter data for this refinement. Enter the destination discount index number from table ACOPT.
	DEST	0 to 1023	Destination route list index. If the entry in subfield OSEL is DEST, datafill this refinement. Enter the number in the route list, of the same translation system, that the call is routed to.
	IAA_INDEX	0 to 1024	Interadministration accounting index. If the entry in subfield OSEL is IAA, datafill this refinement. Enter the value that indexes the corresponding tuple in table IAACtrl.

AMHEAD (continued)**Field descriptions for conditional datafill (Sheet 10 of 14)**

Field	Subfield or refinement	Entry	Explanation and action
	LNET	alphanumeric (1 to 16 characters)	Logical network. If the entry in subfield OSEL is LNET, datafill this refinement. Enter the logical network name that the call is on. The logical network name must be previously datafilled in table LNETWORK. The entry in this field is used by the international metering system to determine a tariff for the call.
	MAX	0 to 30	Maximum digits. If the entry in subfield OSEL is MM, datafill this refinement. Enter the maximum number of digits expected. This value includes the digits used to index the current tuple and must also include the prefix digits specified in the current tuple.
	MIN	0 to 30	Minimum digits. If the entry in subfield OSEL is MM, datafill this refinement. Enter the minimum number of digits expected. This value includes the digits used to index the current tuple and must also include the prefix digits specified in the current tuple.
	MZONE	0 to 63	Metering zone. If the entry in subfield OSEL is MZONE, datafill this refinement. Enter the metering zone of the call, in the logical network as defined by selector LNET. The entry in this field is used by the international metering system to determine a tariff for the call.

AMHEAD (continued)**Field descriptions for conditional datafill (Sheet 11 of 14)**

Field	Subfield or refinement	Entry	Explanation and action
	NETSRV_ NAME	IPHS, DPHS, MOBILE, DA, TELEGRAM, or NCC	<p>Network service name. If the entry in subfield OSEL is NETSRV, datafill this refinement. The entry in this field determines the parameters in an outgoing IAM message.</p> <p>Enter IPHS to indicate a call to an independent personal handyphone system subscriber.</p> <p>Enter DPHS to indicate a call to a dependent personal handyphone system subscriber.</p> <p>Enter MOBILE to indicate a call to a mobile subscriber.</p> <p>Enter DA to indicate a call to the directory assistance operator.</p> <p>Enter TELEGRAM to indicate a call to the Telegram office.</p> <p>Enter NCC to indicate a call routed to one of the following networks:</p> <ul style="list-style-type: none"> • New Common Carrier serving international toll traffic • New Common Carrier serving national toll traffic
	NOA	INTL, LOCAL, NATL or NET	<p>Nature of address. Enter the required called party nature of address as follows:</p> <ul style="list-style-type: none"> • INTL (international) • LOCAL (local) • NATL (national) • NET (Intelligent Network Services)

AMHEAD (continued)

Field descriptions for conditional datafill (Sheet 12 of 14)

Field	Subfield or refinement	Entry	Explanation and action
	ONNET	Y or N	<p>Call on virtual private network. If the entry in subfield OSEL is VPN, datafill this refinement. Enter Y if the call stays within the defined virtual private network. Otherwise, enter N.</p> <p>Overlapped outpulsing is only supported on off-network calls. Calls processed without subfield ONNET set to Y are off-network calls. Meridian Digital Centrex (MDC) calls are treated as off-network calls, and therefore overlapped outpulsing is supported for MDC calls.</p>
	PCCDR	0 to 9, B, C, D, E (1 to 3 digits)	<p>Pseudo country code digits. If the entry in subfield OSEL is PCC, datafill this refinement. Enter the three-digit pseudo country code (PCC). If a two-digit PCC is required, it must be padded by a leading zero.</p> <p>The pseudo country code is used to record a particular pseudo country code. This can be extracted for use by system logic later, for example, two-stage outpulsing.</p>
	PFDIGS	0 to 24	<p>Number of prefix digits. If the entry in subfield OSEL is PF, datafill this refinement. Enter the number of prefix digits. If prefix digits are identified in a previous table, this number is added to the existing value. Prefix digits are not used to index any further translation tables and are not outpulsed, but they do remain stored in call detail records (CDR).</p> <p>Note: If refinements PF and CONSUME are both datafilled for the same tuple, only the entry for the greater of the two values is processed; the other entry is ignored.</p>
	PFXAMA	0 to 4 digits, or N	<p>Called party number prefix in AMA. If NOA is set to NTL, datafill PFXAMA with 0011.</p> <p>If NOA is set to NATL, datafill PFXAMA with 0.</p> <p>If NOA is set to LOCAL or NET, datafill PFXAMA with N.</p>

AMHEAD (continued)**Field descriptions for conditional datafill (Sheet 13 of 14)**

Field	Subfield or refinement	Entry	Explanation and action
	PRIVL	Y or N	Privileged user. If the entry in subfield OSEL is PRIVL, datafill this refinement. Enter Y (yes), if the user is a privileged user (for example, operator). Otherwise, enter N (no).
	SKIPDIGS	0 to 24	Skip digits. If the entry in subfield OSEL is EXTCIC, enter data for this refinement. This field indicates the number of digits to skip before removing the carrier digits from the digit stream. This field operates on the B (called) number, so it is assumed that the system signals the CIC as part of the B number.
	SOURCE	PRESUB or DIALED	Carrier identification code source. If the entry in subfield OSEL is EXTCIC, enter data for this refinement. This field specifies the source of the CIC as follows: <ul style="list-style-type: none"> • PRESUB - presubscribed. Table TRKGRP contains the definition of the CIC. • DIALED - dialed. The subscriber enters the CIC when dialing a call.
	STOPRTMR	Y or N	Stop remote timer. Enter Y to disable the address complete message (ACM) timer of the remote switch. Default is N.
	XLAID	FREE, GENERIC1, GENERIC2, or GENERIC3	AMA translation identifier. If the entry in subfield OSEL is AMAXLAID, datafill this refinement. Enter the AMA translation identifier to be used against table AMAXLAID.

AMHEAD (continued)

Field descriptions for conditional datafill (Sheet 14 of 14)

Field	Subfield or refinement	Entry	Explanation and action
	XLASYS	AC, AM, CT, FA, FT, NSC, OFC, PX	<p>Translation system. If the entry in subfield OSEL is XLT, datafill this refinement. Enter the next translation system to use, as listed below, followed by a space, then datafill refinement XLANAME:</p> <ul style="list-style-type: none"> • AC (access) • AM (ambiguous) • CT (country) • FA (foreign area) • FT (utility) • NSC (number service code) • OFC (office) • PX (prefix) <p>Note: NIL is not a valid entry. NIL is only used to satisfy internal software functionality. NSC is not used in GL03.</p>
	XLANAME	alphanumeric (1 to 8 characters)	<p>Translation name. If the entry in subfield OSEL is XLT, datafill this refinement. Enter the translation name of the table within the XLASYS to which the call is routed.</p>

AMHEAD (continued)**XLASEL = DBQ**

If the entry in field XLASEL is DBQ, datafill the following refinements.

Field descriptions for conditional datafill (Sheet 1 of 2)

Field	Subfield or refinement	Entry	Explanation and action
	OPT	see subfield	Options. This field is a vector consisting of up to ten options. Each option consists of subfield OSEL, and refinements that depend on the entry in subfield OSEL. For each option, specify the option selector (OSEL), followed by a space, then the refinements, each separated by a space. The entry is concluded by a \$ and datafill continues with field DFOP.
	OSEL	MM, NSC, or PF	Option selector. The following options can be selected: Enter MM, followed by a space, and datafill refinements MIN and MAX, if the minimum and maximum dialed digits are known. Enter NSC, followed by a space, and datafill refinement NSCODE, if a number service code operation is to be performed on a call. Enter PF, followed by a space, and datafill refinement PFDIGS if there are prefix digits in the digit stream.
	MAX	0 to 30	Maximum digits. If the entry in subfield OSEL is MM, datafill this refinement. Enter the maximum number of digits expected. This value includes the digits used to index the current tuple and must also include the prefix digits specified in the current tuple.
	MIN	0 to 30	Minimum digits. If the entry in subfield OSEL is MM, datafill this refinement. Enter the minimum number of digits expected. This value includes the digits used to index the current tuple and must also include the prefix digits specified in the current tuple.

AMHEAD (continued)

Field descriptions for conditional datafill (Sheet 2 of 2)

Field	Subfield or refinement	Entry	Explanation and action
	NSCODE	AIN, 800P, E008, E800, MAP_HLR, MAP_MSC, MAP_VLR, PVN, MAPHLR, REPLDIGS, or VPN	<p>Number service code. If the entry in subfield OSEL is NSC, enter the required number service code for the operation to be performed on the call, as listed below:</p> <ul style="list-style-type: none"> • AIN (advanced intelligent network) • 800P (800+) • E008 (Enhanced 008) • E800 (Enhanced 800) • MAP_HLR (mobile application part home location register) • MAP_MSC (mobile application part mobile service switching center) • MAP_VLR (mobile application part visitor location register) • MAPHLR (appears only if feature AE1014 [MAP Interworking to BTUP] is on the switch) • PVN (private virtual network) • REPLDIGS (replace digits) • VPN (virtual private network)
	PFDIGS	0 to 24	<p>Number of prefix digits. If the entry in subfield OSEL is PF, datafill this refinement. Enter the number of prefix digits. If prefix digits are identified in a previous table, then this number is added to the existing value. Prefix digits are not used to index any further translation tables and are not outpulsed, but they do remain stored in call detail records (CDR).</p>

AMHEAD (continued)**XLASEL = DMOD**

If the entry in subfield XLASEL is DMOD, datafill the following refinements.

Field descriptions for conditional datafill (Sheet 1 of 8)

Field	Subfield or refinement	Entry	Explanation and action
	OPT	see subfield	Options. This field is a vector consisting of up to ten options. Each option consists of subfield OSEL, and refinements that depend on the entry in subfield OSEL. For each option, specify the option selector (OSEL), followed by a space, and the refinements, each separated by a space. The entry is concluded by a \$ and datafill continues with field DFOP.
	OSEL	AFTER, CDNRTE, CGNDM, CONSUME, COODM, CPCRTE, DEL, EXTCIC, INSRT, PF, RBP, REPL, SETCDN, VPNREPL, VPNXLT, or XLT	<p>Option selector. The following options can be selected:</p> <p>Enter AFTER, followed by a space, and datafill refinement AFTER if a specific number of digits must be skipped before modifying the digit stream.</p> <p>Enter CDNRTE to route using the called number name (CDNNAME) from table CDNCHAR. If the CDNNAME is present on the incoming call or is set by the SETCDN option, translation proceeds to table CDNUXLA.</p> <p>Enter CGNDM, followed by a space, and datafill refinements PREFXCLI and INSRTCLI to remove digits from the calling line identification (CLI) and insert a datafilled digit string of up to five digits in the prefix string. The total length of the CLI and the digit string can be up to 18 digits. A modified CLI and digit string greater than 18 digits routes the call to treatment.</p> <p>Enter CONSUME, followed by a space, and datafill refinement CONDIGS to specify the number of digits that are consumed during translation.</p>

AMHEAD (continued)

Field descriptions for conditional datafill (Sheet 2 of 8)

Field	Subfield or refinement	Entry	Explanation and action
	<p>OSEL (continued)</p>		<p>Enter COODM, followed by a space, and datafill refinement SERVICE to replace the dialed emergency code by the emergency number stored in table LAC.</p> <p>Note: Option selector COODM must be combined with option XLT to guarantee that translation continues with the modified number. Selector COODM cannot be combined with any other option.</p> <p>Enter CPCRTE to route using the calling party category (CPCNAME) from table CPCCHAR. If the CPCNAME is present on the incoming call, translation proceeds to table CPCUXLA.</p> <p>Enter DEL, followed by a space, and datafill refinement DELDIGS. Further digits are accepted from the agent, and overlapped outpulsing is not affected. Digits being deleted are processed before those being inserted.</p> <p>Enter EXTCIC, followed by a space, and enter data for refinements CICSIZE, SKIPDIGS, and SOURCE. The EXTCIC subfield is the external carrier identification code that indicates a long distance carrier in the global environment. This option is supported for TOPS calls.</p>

AMHEAD (continued)**Field descriptions for conditional datafill (Sheet 3 of 8)**

Field	Subfield or refinement	Entry	Explanation and action
			<p>Enter INSRT, followed by a space, and datafill refinement INSRDIGS. Further digits are accepted from the agent, and overlapped outpulsing is not affected. Digits being deleted are processed before those being inserted.</p> <p>Note: Digit insertion is done in the actual digit stream, and the changes are reflected in call detail records. Replacement and insertion cannot be datafilled in the same tuple. If both options are datafilled, the second option in the tuple is used.</p> <p>Enter PF, followed by a space, and datafill refinement PFDIGS, if there are prefix digits in the digit stream.</p> <p>Enter RBP without refinements. The entry RBP is used when a call is to be marked as Ringback Price. The RBP entry in table ACCODE suffixes a hexadecimal E to the calling digits for a call that translates using a tuple with option RBP.</p> <p>Enter REPL and datafill refinement REPLDIGS. Overlapped outpulsing is disabled, and all digits are collected before continuing.</p> <p>Note: Digit replacement occurs in the actual digit stream, and the changes are reflected in call detail records. Replacement and insertion cannot be datafilled in the same tuple. If both options are datafilled, the second option in the tuple is used.</p>

AMHEAD (continued)

Field descriptions for conditional datafill (Sheet 4 of 8)

Field	Subfield or refinement	Entry	Explanation and action
			<p>Enter SETCDN to trigger the setting of outgoing called party characteristics. This option assigns the called number name (CDNNAME) from table CDNCHAR to the call. If the CDNRTE option is subsequently encountered, the CDNNAME is used to route the call.</p> <p>You can use the SETCDN option to allow CDN routing when incoming agents such as DPNSS or BTUP are not available in table CDNCHAR.</p> <p>Enter VPNREPL to replace the called party digits with the VPN called party digits conveyed across the public network by the QSIG Feature Transparency mechanism.</p> <p>Enter VPNXLT to replace the current translation system and translation name with the values stored in table BGIDMAP. The entry to table BGIDMAP is addressed by the NNI BGID and SIGNIFICANCE information received in the originating signaling for the call.</p> <p>Note: The VPNXLT and XLT options must not both exist in the same tuple.</p> <p>Enter XLT, followed by a space, and datafill refinement XLASYS if the call proceeds to another translation system.</p>

AMHEAD (continued)

Field descriptions for conditional datafill (Sheet 5 of 8)

Field	Subfield or refinement	Entry	Explanation and action
	AFTER	0 to 29	<p>After. If the entry in subfield OSEL is AFTER, datafill this refinement. Enter the number of digits to skip before doing the modification. The default case is to calculate the new prefix fence, and replace, insert, or delete digits after the fence (for example, starting at the next digit). Option AFTER is an additional number of digits to skip before doing the modification. Option AFTER refers to the option datafilled immediately before it. For example:</p> <p>>DMOD DEL 3 AFTER 2 INSRT 11</p> <p>skips two digits, deletes the next three, and inserts digits 11 at the beginning of the digit string. The result when applied to 234567 is 23117.</p> <p>Note: Datafilling this refinement with 0 (the default value), displays the following error message:</p> <pre>Too few digits for AFTER UNSUPPORTED OPTION AT: # PROCESSING ERROR UNEXPECTED ERROR CONDITION</pre>
	CDNNAME	alphanumeric string	Called number name. If the entry in subfield OSEL is SETCDN, enter data for this refinement. Enter data for this refinement to
	CICSIZE	1 to 4	<p>CIC size. If the entry in subfield OSEL is EXTCIC, enter data for this refinement. This field indicates the number of digits in the CIC. This field operates on the B (called) number, so it is assumed that the switch signals the CIC as part of the B number.</p> <p>The MAP display indicates the range is 0 to 4. The system does not allow a 0 entry.</p>

AMHEAD (continued)**Field descriptions for conditional datafill (Sheet 6 of 8)**

Field	Subfield or refinement	Entry	Explanation and action
	CONDIGS	numeric (0 to 29 digits)	Consumed digits. If the entry in subfield OSEL is CONSUME, datafill this refinement. Enter a number to explicitly define the number of digits consumed during call processing.
	DELDIGS	0 to 29	Delete digits. If the entry in subfield OSEL is DEL, datafill this refinement. Enter the number of digits to be deleted, after skipping digits to be left unprocessed.
	INSRDIGS	0 to 29 digits	Insert digits. If the entry in subfield OSEL is INSRT, datafill this refinement. Enter the digits to be inserted, after skipping digits to be left unprocessed.
	INSRTCLI	1 to 5 digits or \$	Insert calling line identification. If the entry in subfield OSEL is CGNDM, datafill this refinement. Enter the new string to insert as the prefix onto the CLI. Enter \$ to specify that no digit string is inserted.
	PFDIGS	0 to 24	Number of prefix digits. If the entry in subfield OSEL is PF, datafill this refinement. Enter the number of prefix digits. If prefix digits are identified in a previous table, this number is added to the existing value. Prefix digits are not used to index any further translation tables and are not outpulsed, but they do remain stored in call detail records (CDR). Note: If refinements PF and CONSUME are both datafilled for the same tuple, only the entry for the greater of the two values is processed; the other entry is ignored.
	PREFXCLI	0 to 18	Prefix calling line identification. If the entry in subfield OSEL is CGNDM, datafill this refinement. Enter the number of prefix digits to delete.
	REPLDIGS	numeric (0 to 30 digits)	Replace digits. If the entry in subfield OSEL is REPL, datafill this refinement. Enter the digits that replace the existing digits, after skipping digits to be left unprocessed.

AMHEAD (continued)**Field descriptions for conditional datafill (Sheet 7 of 8)**

Field	Subfield or refinement	Entry	Explanation and action
	SERVICE	alphanumeric (1 to 8 characters)	COODM service. If the entry in subfield OSEL is COODM, datafill this refinement. Enter the emergency service name. Emergency service names are listed in field EMRGSERV in table LAC.
	SKIPDIGS	0 to 24	Skip digits. If the entry in subfield OSEL is EXTCIC, enter data for this refinement. This field indicates the number of digits to skip before removing the carrier digits from the digit stream. This field operates on the B (called) number, so it is assumed that the system signals the CIC as part of the B number.
	SOURCE	PRESUB or DIALED	Carrier identification code source. If the entry in subfield OSEL is EXTCIC, enter data for this refinement. This field specifies the source of the CIC as follows: <ul style="list-style-type: none"> • PRESUB - presubscribed. Table TRKGRP contains the definition of the CIC. • DIALED - dialed. The subscriber enters the CIC when dialing a call.

AMHEAD (continued)

Field descriptions for conditional datafill (Sheet 8 of 8)

Field	Subfield or refinement	Entry	Explanation and action
	XLASYS	AC, AM, CT, FA, FT, NSC, OFC, or PX	<p>Translation system. If the entry in subfield OSEL is XLT, datafill this refinement. Enter the next translation system to use, followed by a space, and datafill subfield XLANAME (the instance of the translation system).</p> <p>The choice of translation systems is as follows:</p> <ul style="list-style-type: none"> • AC (access) • AM (ambiguous) • CT (country) • FA (foreign area) • FT (utility) • NSC (number service code) • OFC (office) • PX (prefix) <p>Note: NIL is not a valid entry. NIL is only used to satisfy internal software functionality. NSC is not used in GL03.</p>
	XLANAME	alphanumeric (1 to 8 characters)	<p>Translation name. If the entry in subfield OSEL is XLT, datafill this refinement. Enter the translation name of the table within the XLASYS to which the call is routed.</p>

XLASEL = DNRTE

If the entry in subfield XLASEL is DNRTE, datafill the following refinements. Selector DNRTE allows translation to continue in table DNINV. Through this translation, calls can be terminated at directory numbers (DN) datafilled in table DNINV.

After datafilling table ACHEAD, table DNINV must be datafilled before selector DNRTE is datafilled in table ACCODE.

AMHEAD (continued)

Table AMAXLAID must be datafilled prior to selecting option AMAXLAID in field OSEL.

Field descriptions for conditional datafill (Sheet 1 of 4)

Field	Subfield or refinement	Entry	Explanation and action
	OPT	see subfield	Options. This field is a vector consisting of up to ten options. Each option consists of subfield OSEL, and refinements that depend on the entry in subfield OSEL. For each option, specify the option selector (OSEL), followed by a space, and the refinements, each separated by a space. The entry is concluded by a \$ and datafill continues with field DFOP.
	OSEL	ALLOWOVLP, AMAXLAID, CAMA, CLASS, DN, MM, PF, or SF	<p>Option selector. The following options can be selected:</p> <p>Enter ALLOWOVLP to allow overlap. This subfield does not have refinements.</p> <p>Enter AMAXLAID, followed by a space, and datafill refinement XLAID to specify an automatic message accounting (AMA) identity from within table AMAXLAID.</p> <p>Enter CAMA, followed by a space, and datafill refinement CLDFMT. The entry in CLDFMT indicates whether the international centralized AMA (ICAMA) record is generated with the originally-signaled DN or the final public switched telephone network (PSTN) number.</p>

AMHEAD (continued)**Field descriptions for conditional datafill (Sheet 2 of 4)**

Field	Subfield or refinement	Entry	Explanation and action
	OSEL (continued)		<p>Enter CLASS, followed by a space, and datafill refinement CLASS if the class of the dialed digits is determined.</p> <p>Enter DN, followed by a space, and datafill refinements SNPA and OFC for the DN that the call is routed to.</p> <p>Enter MM, followed by a space, and datafill refinements MIN and MAX if the minimum and maximum dialed digits are known.</p> <p>Enter PF, followed by a space, and datafill refinement PFDIGS if there are prefix digits in the digit stream.</p> <p>Enter SF, followed by a space, and datafill refinement SFDIGS to indicate the beginning of the station code digits.</p>
	CLDFMT	CURRENT, POSTXLA	<p>Called format. If the entry in subfield OSEL is CAMA, enter either CURRENT or POSTXLA to produce the required ICAMA record format.</p> <p>If the entry is CURRENT, an ICAMA record is produced with the signaled DN (without translation).</p> <p>If the entry is POSTXLA, an ICAMA record is produced with the public switched telephone network (PSTN) number resulting from translations.</p>

AMHEAD (continued)**Field descriptions for conditional datafill (Sheet 3 of 4)**

Field	Subfield or refinement	Entry	Explanation and action
	CLASS	ATT, CNTL, COLL, DATT, EMRG, IAGRP, ICNTL, INTL, IOPRA, LCL, NATL, OPRA, RURAL, SPEC, UNKW, or URBAN	<p>Translation class. If the entry in subfield OSEL is CLASS, datafill this refinement. Enter the translation class determined by the dialed digits. This can be used for screening or billing purposes as described under CLASS in screening and charging options.</p> <ul style="list-style-type: none"> • ATT (attendant console) • CNTL (continental) • COLL (collect) • DATT (dial attendant) • EMRG (emergency) • IAGRP (interagent group) • ICNTL (intercontinental) • INTL (international) • IOPRA (international operator assisted) • LCL (local) • NATL (national) • OPRA (operator assisted) • RURAL (rural) • SPEC (special) • UNKW (unknown) • URBAN (urban)
	MAX	0 to 30	<p>Maximum digits. If the entry in subfield OSEL is MM, datafill this refinement. Enter the maximum number of digits expected. This value includes the digits used to index the current tuple and must also include the prefix digits specified in the current tuple.</p>
	MIN	0 to 30	<p>Minimum digits. If the entry in subfield OSEL is MM, datafill this refinement. Enter the minimum number of digits expected. This value includes the digits used to index the current tuple and must also include the prefix digits specified in the current tuple.</p>

AMHEAD (continued)**Field descriptions for conditional datafill (Sheet 4 of 4)**

Field	Subfield or refinement	Entry	Explanation and action
	OFC	numeric (1 to 7 digits)	Seven-digit office code. If the entry in subfield OSEL is DN, enter the office code for the DN that the call is routed to.
	PFDIGS	0 to 24	Number of prefix digits. If the entry in subfield OSEL is PF, datafill this refinement. Enter the number of prefix digits. If prefix digits are identified in a previous table, then this number is added to the existing value. Prefix digits are not used to index any further translation tables and are not outpulsed, but they do remain stored in call detail records (CDR).
	SFDIGS	0 to 29	Station fence digits. If the entry in subfield OSEL is SF, datafill this refinement. Enter a number to indicate how many digits to advance past the start of the digits that index into the tuple. During call processing, the station code digits consist of all digits beyond this indicator to the end of the dialled digits. If option SF is not datafilled, then the last four digits comprise the station code.
	SNPA	000 to 999 (3 digits)	Serving number plan area. If the entry in subfield OSEL is DN, enter the required serving number plan area (SNPA). This number must be datafilled in table HNPACONT or in table SNPANAME.
	XLAID	FREE, GENERIC1, GENERIC2, or GENERIC3	AMA translation identifier. If the entry in subfield OSEL is AMAXLAID, enter the AMA translation identifier to be used against table AMAXLAID.

AMHEAD (continued)**XLASEL = FEAT**

If the entry in field XLASEL is FEAT, datafill the following refinements.

Field descriptions for conditional datafill (Sheet 1 of 3)

Field	Subfield or refinement	Entry	Explanation and action
	OPT	see subfield	Options. This field is a vector consisting of up to ten options. Each option consists of subfield OSEL, and refinements that depend on the entry in subfield OSEL. For each option, specify the option selector (OSEL), followed by a space, and the refinements, each separated by a space. The entry is concluded by a \$ and datafill continues with field DFOP.
	OSEL	FTR, FUNC, MM, PF, or XLT	<p>Option selector. The following options can be selected:</p> <p>Enter FTR, followed by a space, and datafill refinement FTR to identify the international line feature.</p> <p>Enter FUNC, followed by a space, and datafill refinement FUNC to identify the international line feature function.</p> <p>Enter MM, followed by a space, and datafill refinements MIN and MAX if the minimum and maximum dialed digits are known.</p> <p>Enter PF, followed by a space, and datafill refinement PFDIGS if there are prefix digits in the digit stream.</p> <p>Enter XLT, followed by a space, and datafill refinement XLANAME if the translation name of the translation system is known.</p>

AMHEAD (continued)

Field descriptions for conditional datafill (Sheet 2 of 3)

Field	Subfield or refinement	Entry	Explanation and action
	FTR	CALLBACK, CALLCHAR, CLCTDIGS, JES, NTC, VMWI, VSC or VALIDATE	<p>Feature name. If the entry in subfield OSEL is FTR, enter the refinement name shown below:</p> <ul style="list-style-type: none"> • CALLBACK (call back) • CALLCHAR (call characters) • CLCTDIGS (collect digits) • JES (Japan emergency services) • NTC (Notify Time Charges) • TLC (trunk logic circuit) • VMWI (voice mail waiting indication) • VSC (vertical service code) • VALIDATE (not used in GL03)
	FUNC	ACT, DEACT, DELETE, INTER, PROG, or USAGE	<p>Feature function code. If subfield OSEL is set to FUNC, enter one of the international line feature function codes listed below:</p> <ul style="list-style-type: none"> • ACT (activate) • DEACT (deactive) • DELETE (delete) • INTER (interrogate) • PROG (programming) • USAGE (usage)
	MAX	0 to 30	<p>Maximum digits. If the entry in subfield OSEL is MM, datafill this refinement. Enter the maximum number of digits expected following MIN entry and a space. This value includes the digits used to index the current tuple and must also include the prefix digits specified in the current tuple.</p>

AMHEAD (continued)**Field descriptions for conditional datafill (Sheet 3 of 3)**

Field	Subfield or refinement	Entry	Explanation and action
	MIN	0 to 30	Minimum digits. If the entry in subfield OSEL is MM, datafill this refinement. Enter the minimum number of digits expected. This value includes the digits used to index the current tuple and must also include the prefix digits specified in the current tuple.
	PFDIGS	0 to 24	Number of prefix digits . If the entry in subfield OSEL is PF, datafill this refinement. Enter the number of prefix digits. If prefix digits are identified in a previous table, this number is added to the existing value. Prefix digits are not used to index any further translation tables and are not outputted, but they remain stored in call detail records (CDR).

XLASEL = FEATINFO

If the entry in subfield XLASEL is FEATINFO, datafill the following refinements. Selector FEATINFO makes use of table DNSCRN to store information against DNs, which is used during call processing to determine how to proceed with the call. The screening function is triggered by selector FEATINFO in the universal translation tables. The options available with this selector are shown below.

Field descriptions for conditional datafill (Sheet 1 of 10)

Field	Subfield or refinement	Entry	Explanation and action
	FTR	CALLBACK, CALLCHAR, CLCTDIGS, JES, NTC, TLC, or VALIDATE	Feature name. Enter CALLBACK to enable originator callback during translations. Datafill subfield CALLBACK_OPTION and its refinements, then datafill subfields PFDIGS, MINDIGS, MAXDIGS, and TABREF. Enter CALLCHAR to modify all signaling characteristics. Datafill subfields CLLCHROP, PFDIGS, MINDIGS, MAXDIGS, and TABREF.

AMHEAD (continued)

Field descriptions for conditional datafill (Sheet 2 of 10)

Field	Subfield or refinement	Entry	Explanation and action
			<p>Enter CLCTDIGS to collect digits from the call originator and add them to the called digits stream for translation. Datafill subfields CLDGMIN, CLDGMAX, CLCTDIGS_OPTION, PFDIGS, MINDIGS, MAXDIGS, and TABREF.</p> <p>Enter JES to activate the Japan Emergency Service feature. Datafill refinements PFDIGS and TABREF.</p> <p>Enter NTC to notify the originating subscriber of applicable time and charges after the call terminates. Datafill subfield SUBOPT_NAME and its refinement, then datafill subfields PFDIGS, MINDIGS, MAXDIGS, and TABREF.</p> <p>Enter TLC to enable the test line call feature, which provides audible ringback tone followed by dial tone after specified durations. Datafill subfields RING_BACK_TONE_DUR, DIAL_TONE_DUR, TLC_PREFIX_DIGS, TLC_NUM_DIGS, and TLC_CHARGE.</p> <p>Enter VALIDATE, and datafill subfield VALDATOP and its refinements. Datafill subfields PFDIGS, MINDIGS, MAXDIGS, and TABREF.</p>
	CALLBACK_OPTION	CLCTDEST or NIL	<p>Callback option. If the entry in field FTR is CALLBACK, datafill this option. Enter CLCTDEST to call back the subscriber and collect destination digits. Datafill subfields CLDGMIN, CLDGMAX, DISC_ANNC_TRK, PROMPT_ANNC_TRK, and SEND_ANM. Otherwise, enter NIL.</p>
	CLDGMIN	1 to 24	<p>Minimum collected digits. Enter the minimum number of digits to be collected and entered into the called digit stream.</p>

AMHEAD (continued)**Field descriptions for conditional datafill (Sheet 3 of 10)**

Field	Subfield or refinement	Entry	Explanation and action
	CLDGMAX	1 to 24	Maximum collected digits. Enter maximum number of digits to be collected and written into the called digit stream. The value cannot be less than CLDGMIN.
	DISC_ANNC_TRK	alphanumeric (1 to 16 characters)	Disconnect announcement trunk. Enter trunk common language location identifier (CLLI).
	PROMPT_ANNC_TRK	alphanumeric (1 to 16 characters)	Prompt announcement trunk. Enter trunk the common language location identifier (CLLI).
	SEND_ANM	Y or N	Send answer message. Enter Y (yes) or N (no).
	CLLCHROP	NOCHGMSG or EARLYCPG	Call characteristics. If the entry in field FTR is CALLCHAR, datafill this option. Enter NOCHGMSG to block backward CHG message. Enter EARLYCPG to specify that a call progress (CPG) message is issued in the backwards direction before an address complete message (ACM) is sent. The CPG message is permitted before an ACM in certain ISDN user part (ISUP) variants to establish a bidirectional speech path and to stop the T7 timer.
	CLCTDIGS_OPTION	NIL or \$	Collect digits option. If the entry in field FTR is CLCTDIGS, datafill this option. Enter NIL or enter \$ to proceed to the next option.
	SUBOPT_NAME	DUR_ADJ	Suboption name. If the entry in field FTR is NTC, datafill this option. Enter DUR_ADJ to specify the duration adjustment for NTC and datafill subfield DURATION_ADJ.
	DURATION_ADJ	0 to 99	Duration adjustment. Enter the time in seconds.

AMHEAD (continued)**Field descriptions for conditional datafill (Sheet 4 of 10)**

Field	Subfield or refinement	Entry	Explanation and action
	RING_BACK_TONE_DUR	1 to 255	Ringback tone duration. If the entry in field FTR is TLC, datafill this option. Enter the time, in seconds, that ringback tone is provided to the originator.
	DIAL_TONE_DUR	1 to 255	Dial tone duration. If the entry in field FTR is TLC, datafill this option. Enter the time, in seconds, that dial tone is provided to the originator.
	TLC_PREFIX_DIGS	0 to 18	Prefix digits in called number. If the entry in field FTR is TLC, datafill this option. Enter the number of digits to advance the prefix fence to detect the charge message digits when CPC = PAYPHONE.
	TLC_NUM_DIGS	numeric(3 or 4) Japan only	Test line call number of digits. Enter the number of dialed digits to be transferred to the NCCI#7 CHG message. This is also the number of digits stored in the LMNNUM field of the SMDR #DE record.
	TLC_CHARGE	Y or N	Test line call charge indicator. The TLC_CHARGE field indicates the billing status of an ISUP test call. Enter Y if the call is billable. Enter N if the call is not billable. The default value for this field is N.
	OPT	see subfield VALDATOP	Options. If the entry in field FTR is VALIDATE, datafill this option. This field is a vector consisting of up to five options. Each option consists of subfield VALDATOP, and refinements that depend on the entry in subfield VALDATOP. For each option, specify VALDATOP, followed by a space, then the refinements, each separated by a space. The entry is concluded by a \$ and datafill continues with field DFOP.

AMHEAD (continued)**Field descriptions for conditional datafill (Sheet 5 of 10)**

Field	Subfield or refinement	Entry	Explanation and action
	VALDATOP	BCSCRN, CALLED, CLDTCOLG, CLISERV, CUSTMOD, LCASCRN, NOCHARGE, PRESEL, SCRNLNTH, SUBSCRN, TCNOTSCR, THIRDPTY, VERDEST, V3PTYBIL	<p>Validate option. Enter a list of up to five options. The options specify what characteristics are to be considered when screening the call. Enter \$ to signify the end of the list.</p> <p>Note: Selector VALIDATE is traversed only once for each call.</p> <p>Enter BCSCRN and datafill refinement BCOPTS to identify the bearer capability name.</p> <p>Enter CALLED to indicate the number to be used for screening. The SUBSCRN options are used to specify the subscriber types allowed to receive the call.</p> <p>Note: When using option CALLED, there must be no further digit manipulation after selector VALIDATE is encountered in translations.</p> <p>If option CALLED is not entered, then the calling party number is used for screening and the SUBSCRN options are used to specify the subscriber types allowed to make the call.</p> <p>Note: Pay phone subscribers are treated as general subscribers if option CALLED is specified.</p> <p>Enter CLDTCOLG, followed by a space, to copy digits from the called to the calling digit stream, and datafill options OFFSET and COUNT.</p> <p>Enter CLISERV, followed by a space, and enter data for refinement SERVNAME to add the name of the service provider.</p>

AMHEAD (continued)

Field descriptions for conditional datafill (Sheet 6 of 10)

Field	Subfield or refinement	Entry	Explanation and action
			<p>Enter CUSTMOD, followed by a space, to alter the internal network class of service (NCOS) and customer group to new value for a given directory number (DN) based on the CUSTINFO attribute in table DNSCRN. The source of the DN used as an index into table DNSCRN is determined by the VALIDATE datafill. Datafill refinement CUSTSCRN.</p> <p>Enter LCASCRN, followed by a space, to enable local calling area screening. The called and calling numbers are checked against tables LCARNAME and LCASCRN to determine if the numbers are local to each other, and whether the call should be denied or allowed to continue routing.</p> <p>Enter NOCHARGE, followed by a space, to indicate that the call is nonbillable.</p> <p>Note: If both NOCHARGE and THIRDPTY options are specified, NOCHARGE takes precedence.</p> <p>Enter PRESEL to allow screening for the PRESEL attribute in table DNSCRN.</p> <p>Enter SCRNLNTH, followed by a space, and datafill refinement MINLNTH to specify the minimum length of the number being screened.</p> <p>Enter SUBSCRN, followed by a space, and datafill up to three multiples of the following subscriber types: GENERAL, PAYPHONE, PERSONAL, and MOBILE. Enter \$ after entering SUBSCRN to indicate that no subscriber types are permitted to make or receive the call.</p> <p>Enter TCNOTSCR to indicate that calls with CPC set to Test Call are not screened.</p>

AMHEAD (continued)

Field descriptions for conditional datafill (Sheet 7 of 10)

Field	Subfield or refinement	Entry	Explanation and action
			<p>Enter THIRDPY to indicate that automatic third party billing is used. Table DNSCRN is checked for attribute UNPAID.</p> <p>Note: If both NOCHARGE and THIRDPY options are specified, NOCHARGE takes precedence.</p> <p>Note: Payphone subscribers are treated as general subscribers if option CALLED is specified.</p> <p>Enter VERDEST to verify the destination of a call. Called digits are checked against ADDCODE entries in table DNSCRN.</p> <p>Enter V3PTYBIL to verify third party billing. Called digits are checked against table DNSCRN to determine authorization and account status.</p> <p>Note: NIL appears on the switch range but is not a valid entry. The value NIL is used only to satisfy internal software requirements.</p>
	BCOPTS	alphanumeric (1 to 8 characters)	Bearer capability option. If the entry in field VALDATOP is BCSCRN, datafill this refinement. Enter up to four bearer capability names.
	COUNT	0 to 30	If the entry in field VALDATOP is CLDTCCLG, enter subfield COUNT to count the digits from the called stream to the calling stream.

AMHEAD (continued)

Field descriptions for conditional datafill (Sheet 8 of 10)

Field	Subfield or refinement	Entry	Explanation and action
	CUSTSCRN	Y or N	<p>Customer screen. Enter Y to block calls that are not subscribed to the switched on-net services if attempting a switched on-net call. If the DN being screened is not present in table DNSCRN, the call is rejected with the Call Not Allowed (CNAD) treatment. The internal NCOS and CUSTGRP associated with the call are altered to the values found in the CUSTINFO attribute if present for the given DN in table DNSCRN. The DN used to index table DNSCRN can be the subscriber calling line identification (CLI) or the dialed number. The source of the DN is determined by the datafill of field VALIDATE.</p> <p>Enter N if no screening is performed.</p>
<p>Note: The FEATINFO values CCANN, CCARD, CCSDT, DAFOP, FAXSUP, FAXTEST, INBFAX, INBFD, INTLFD, ISD, ISDTST, ISDVRE, OUTBFAX, OUTBFD, PB3RDPTY, PBCALL, PBISSD, PBISSDVRE, and PBTST are valid only in DMS-250 switching offices. Additional DMS-250 parameters are listed in the DMS-250 specific data schema NTPs.</p>			
	MINLNTH	0 to 18 values from 0 to 30 are possible in APC software loads	Minimum length. If the entry in field VALDATOP is SCRNLNTH, enter the minimum number of digits required in number being screened.
	OFFSET	0 to 30	If the entry in field VALDATOP is CLDTCGLG, enter subfield OFFSET to offset the digits from the called stream to the calling stream.
	SERVNAME	alphanumeric string	Service provider name. If the entry in field VALDATOP is CLISERV, enter the name of the service provider in this refinement.
	SUBSCTYP	GENERAL, PAYPHONE, PERSONAL, or MOBILE	Subscriber type. Enter subscriber type, followed by a space, and datafill refinements WHITLIST, CHKBLKCL, CHKUNPD, and CHKCCR. This option allows you to specify which subscriber types are permitted to make or receive a call and whether the subscriber's standing is important for a call.

AMHEAD (continued)**Field descriptions for conditional datafill (Sheet 9 of 10)**

Field	Subfield or refinement	Entry	Explanation and action
	WHITLIST	Y or N	Whether it list. Enter Y (yes) to indicate that the subscriber's directory number must be datafilled in table DNSCRN. Otherwise, enter N (no).
	CHKBLKCL	Y or N	Check block call. Enter Y to check if the subscriber has subscribed to all services for which this tuple is being used (BLKCALL attribute in table DNSCRN). Otherwise, enter N.
	CHKUNPD	Y or N	Check unpaid. Enter Y to check if the subscriber has paid his bills. Otherwise, enter N.
	CHKCCR	Y or N	Check cumulative call restriction. Enter Y to check the subscriber's cumulative charge limit. Otherwise, enter N.
	PFDIGS	0 to 24	Prefix digits. Enter the number of prefix digits present at this point in the call. Prefix digits are not used to index any further translation tables and are not outpulsed, but they remain stored in call detail records (CDR).
	MINDIGS	0 to 30	Minimum digits. Enter the minimum number of digits expected. This value includes the digits used to index the current tuple and must also include the prefix digits specified in the current tuple.
	MAXDIGS	0 to 30	Maximum digits. Enter the maximum number of digits expected. This value includes the digits used to index the current tuple and must also include the prefix digits specified in the current tuple.
	TABREF	see subfields	Table reference. This field consists of subfields XLASYS and XLANAME.

AMHEAD (continued)

Field descriptions for conditional datafill (Sheet 10 of 10)

Field	Subfield or refinement	Entry	Explanation and action
	XLASYS	AC, AM, CT, FA, FT, NSC, OFC, or PX	<p>Translation system. Enter the next translation system to use, followed by a space, and datafill subfield XLANAME (the instance of the translation system).</p> <p>The choice of translation systems is as follows:</p> <ul style="list-style-type: none"> • AC (access) • AM (ambiguous) • CT (country) • FA (foreign area) • FT (utility) • NSC (number service code) • OFC (office) • PX (prefix) <p>Note: NIL is not a valid entry. NIL is used only to satisfy internal software functionality.</p>
	XLANAME	alphanumeric (1 to 8 characters)	Translation name. Enter the translation name of the table instance within the XLASYS to which the call is routed.

XLASEL = HRC

If the entry in subfield XLASEL is HRC, datafill the following refinements.

Field descriptions for conditional datafill (Sheet 1 of 2)

Field	Subfield	Entry	Explanation and action
	OPT	see subfield	Options. This field contains subfield OSEL, and refinements that depend on the entry in subfield OSEL. The entry is concluded by a \$ and datafill continues with field DFOP.
	OSEL	PFBILL, XLT	Option selector. If the call proceeds to another translation system, enter XLT, followed by a space, and datafill refinement XLASYS. Also complete an entry for option selector PFBILL.

AMHEAD (continued)**Field descriptions for conditional datafill (Sheet 2 of 2)**

Field	Subfield	Entry	Explanation and action
	XLASYS	AC, AM, CT, FA, FT, NSC, OFC, PX	<p>Translation system. If option selector XLT is entered in subfield OSEL, datafill this refinement. Enter the next translation system to use, followed by a space, then datafill refinement XLANAME. Enter one of the following:</p> <ul style="list-style-type: none"> • AC (access) • AM (ambiguous) • CT (country) • FA (foreign area) • FT (utility) • NSC (number service code) • OFC (office) • PX (prefix) <p>Note: NIL is not a valid entry. NIL is used only to satisfy internal software functionality. NSC is not used in GL03.</p>
	XLANAME	alphanumeric (1 to 8 characters)	Translation name. If XLT is entered in subfield OSEL, datafill this refinement. Enter the translation name of the table within the XLASYS to which the call is routed.
	PFBILL	Y or N	Prefix billing option. Enter PFBILL, followed by a space, and then enter either Y or N. If "Y" is entered, the home routing code specified in the tuple is included in the billing record. If "N" is entered, the home routing code is not included in billing records.

AMHEAD (continued)**XLASEL = IAC**

If the entry in subfield XLASEL is IAC, datafill the following refinements.

1xxxField descriptions for conditional datafill

Field	Subfield or refinement	Entry	Explanation and action
	OPT	see subfield	Options. This field is a vector list consisting of up to ten options. Each option consists of subfield OSEL, and refinements that depend on the entry in subfield OSEL. The entry is concluded by a \$ and datafill continues with field DFOP.
	OSEL	PF	Option selector. Enter PF, followed by a space, and datafill refinement PFDIGS, if there are prefix digits in the digit stream.
	PFDIGS	0 to 24	Number of prefix digits. If the entry in subfield OSEL is PF, datafill this refinement. Enter the number of prefix digits. If prefix digits are identified in a previous table, then this number is added to the existing value. Prefix digits are not used to index any further translation tables and are not outputted, but they remain stored in call detail records (CDR).

XLASEL = RTE

If the entry in subfield XLASEL is RTE, datafill the following refinements.

AMHEAD (continued)

Table AMAXLAID must be datafilled prior to selecting option AMAXLAID in field OSEL.

Field descriptions for conditional datafill (Sheet 1 of 15)

Field	Subfield or refinement	Entry	Explanation and action
	OPT	see subfield	Options. This field is a vector consisting of up to ten options. Each option consists of subfield OSEL, and refinements that depend on the entry in subfield OSEL. For each option, specify the option selector (OSEL), followed by a space, and the refinements, each separated by a space. The entry is concluded by a \$ and datafill continues with field DFOP.
	OSEL	ACF, AMAXLAID, BLKOVLP, CALLCTRL, CAMA, CDN, CDNRTE, CLASS, CONSUME, CPCRTE, CPMCALL, DDIDX, DEST, EXTCIC, IAA, LNET, MM, MZONE, NETSRV, PCC, PF, PIP, PNRF, PRESEL, PRESELRTE PRIVL, QFT, SETCDN, TOC, VPN, or VPNPAN	Option selector. The following options can be selected: Enter ACF, followed by a space, and datafill refinement ACF, if the area code fence is defined. Enter AMAXLAID, followed by a space, and datafill refinement XLAID, to specify an automatic message accounting (AMA) identity from within table AMAXLAID. Enter BLKOVLP to prevent calls from being outpulsed until all CDN digits are collected. This subfield does not have refinements. Enter CALLCTRL, followed by a space, and datafill refinement CALLCTRL. The entry in refinement CALLCTRL indicates who has control of the call: the calling party, the called party, or both.

AMHEAD (continued)**Field descriptions for conditional datafill (Sheet 2 of 15)**

Field	Subfield or refinement	Entry	Explanation and action
			<p>Enter CAMA, followed by a space, and datafill refinement CLDFMT. The entry in refinement CLDFMT indicates whether the international centralized automatic message accounting (ICAMA) record is generated with either the originally signaled directory number (DN) or the final public switched telephone network (PSTN) number.</p> <p>Enter CDN, followed by a space, and datafill refinement CDN to select the nature of address field. This field is used to identify the called party of the initial address message (IAM). It is used for Australian ISDN user part (AISUP) call translations.</p> <p>Enter CDN RTE to route using the called number name (CDNNAME) from table CDNCHAR. If the CDNNAME is present on the incoming call or is set by the SETCDN option, translation proceeds to table CDNUXLA.</p> <p>Enter CLASS, followed by a space, and datafill refinement CLASS, if the class of the dialed digits is determined.</p> <p>Enter CONSUME, followed by a space, and datafill refinement CONDIGS, to specify the number of digits that are consumed during translation.</p> <p>Enter CPC RTE to route using the calling party category (CPCNAME) from table CPCCHAR. If the CPCNAME is present on the incoming call, translation proceeds to table CPCUXLA.</p> <p>Enter CPMCALL, followed by a space, and datafill refinement CPMCALL, to specify call billing against the called party instead of the calling party for intraoffice calls.</p>

AMHEAD (continued)**Field descriptions for conditional datafill (Sheet 3 of 15)**

Field	Subfield or refinement	Entry	Explanation and action
			<p>Enter DDIDX, followed by a space, and enter data for refinement DDIDX. Enter data for this subfield if a destination discount applies to the call.</p> <p>Enter DEST, followed by a space, and datafill refinement DEST, the index into the route table of the current XLASYS and XLANAME.</p> <p>Enter EXTCIC, followed by a space, and enter data for refinements CICSIZE, SKIPDIGS, and SOURCE. This subfield indicates the external carrier identification code.</p> <p>Enter IAA and the datafill refinement IAA_INDEX to generate or modify IAA message parameters based on datafill in table IAACtrl.</p> <p>Enter LNET, followed by a space, and datafill refinement LNET, the index into table LNETWORK, to find the international metering system tariff for the call.</p>

AMHEAD (continued)

Field descriptions for conditional datafill (Sheet 4 of 15)

Field	Subfield or refinement	Entry	Explanation and action
			<p>Enter MM, followed by a space, and datafill refinements MIN and MAX, if the minimum and maximum number of expected digits dialed are known. These values include the digits used to index the current tuple and must also include the prefix digits specified in the current tuple.</p> <p>Note: For fast interdigital timing to function properly, MM can only be used with the RTE selector whenever the value in refinement MIN is not equal to the value in refinement MAX.</p> <p>In other words, if MIN=MAX, MM can be used with the CONT selector in table PXCORE; if the value in refinement MIN is not equal to the value in refinement MAX, MM cannot be used until the RTE selector is used (which is usually in either table FACODE or table OFCCODE).</p> <p>If refinements MIN and MAX are set in table PXCORE when they are not equal to each other, partial dial timing is used after MIN digits are dialed in order to determine the end of dialing.</p> <p>Enter MZONE, followed by a space, and datafill refinement MZONE, if metering is done on the call.</p> <p>Enter NETSRV and datafill refinement NETSRV_NAME to indicate a Japan network service.</p> <p>Enter PCC, followed by a space, and datafill refinement PCCDR, if a pseudo country code is required.</p>

AMHEAD (continued)**Field descriptions for conditional datafill (Sheet 5 of 15)**

Field	Subfield or refinement	Entry	Explanation and action
			<p>Enter PF, followed by a space, and datafill refinement PFDIGS, the prefix fence. This is the number of prefix digits associated with this tuple (that is, if some prefix digits were identified in a previous table, then the number here is added to the existing value). Prefix digits are not used to index any further translation tables and are not outpulsed, but they remain stored in call detail records (CDR).</p> <p>Enter PIP, followed by a space, to perform a residency check for the digits being translated. The residency check is used by the local number portability feature to ensure that calls to DNs that have been ported into the office are not routed out of the office.</p> <p>Note: You must complete entries in fields MIN and MAX before entering the PIP option.</p> <p>Enter PNRF to invoke the ported number recognition function, which is used for LNP applications in Germany. The PNRF option does not require any subfields.</p> <p>Enter PRESEL, followed by a space, and datafill refinement PRESEL to provide the necessary information used to index into the PCIXLA table.</p> <p>Enter PRESELRTE, followed by a space, and datafill refinement PRESELRTE, the index into the route table of the current XLASYS and XLANAME.</p> <p>Enter PRIVL, followed by a space, and datafill refinement PRIVL, if the user is a privileged user (for example, operators).</p>

AMHEAD (continued)

Field descriptions for conditional datafill (Sheet 6 of 15)

Field	Subfield or refinement	Entry	Explanation and action
			<p>Enter QFT followed by ON or OFF to indicate if an outgoing route is capable of QSIG Feature Transparency.</p> <p>Note: The QFT ON option must not be added to a route unless the far-end node is QFT-capable.</p> <p>Enter SETCDN to trigger the setting of outgoing called party characteristics. This option assigns the called number name (CDNNAME) from table CDNCHAR to the call. If the CDNRTE option is subsequently encountered, the CDNNAME is used to route the call.</p> <p>You can use the SETCDN option to allow CDN routing when incoming agents such as DPNSS or BTUP are not available in table CDNCHAR.</p> <p>Enter TOC, followed by a space, and datafill refinement CHG for the type of charge where the type of charge messaging is to be selected.</p> <p>Enter VPN, followed by a space, and datafill refinements ONNET and BILLABLE if the call routes through a service switching point (SSP) and feature package NTXH49AA or NTXH49AB (VPN-SSP) is in the switching unit.</p> <p>Enter VPNPAN to indicate that the PINX is to act as the PAN for an outgoing route.</p> <p>Note: If VPNREPL or VPNXLT have been entered in the DMOD selector, the VPNPAN option is redundant.</p>
	ACF	0 to 29	<p>Area code fence. If the entry in subfield OSEL is ACF, datafill this refinement. Enter the number of digits between the beginning of the digits to currently index the table, and the end of the area code.</p>

AMHEAD (continued)**Field descriptions for conditional datafill (Sheet 7 of 15)**

Field	Subfield or refinement	Entry	Explanation and action
	BILLABLE	Y or N	<p>Virtual private network billable call. If the entry in subfield OSEL is VPN, enter Y if an automatic message accounting (AMA) record is required for each VPN call. Otherwise, enter N.</p> <p>An AMA record is not generated if an address complete message (ACM) of address complete, no charge is returned, or if the call terminates in the SSP on a line with the free number terminating (FNT) option.</p>
	CALLCLASS	PRESELECT OVERRIDE CSNTRUNK, FLEXCHG_ VALUE, CHGIND, ISUPPREF	<p>Preselection call processing. If the entry in subfield OSEL is PRESEL, datafill this refinement. Enter the preselection call class type that is associated with the call.</p> <p>Note: Calltype CSN and TRUNK are available under the PRESEL option. These call classes are not needed for German Carrier Selection, and are not supported. The same applies to the Continue option of CONT. For the German market only NOCONT is supported.</p>

AMHEAD (continued)**Field descriptions for conditional datafill (Sheet 8 of 15)**

Field	Subfield or refinement	Entry	Explanation and action
	CALLCTRL	CALLED, CALLING, LAST, or MUTUAL	<p>Call control. If the entry in subfield OSEL is CALLCTRL, datafill this refinement. Enter one of the following values to specify the party controlling the call:</p> <ul style="list-style-type: none"> • If the entry is CALLED and the called line goes on-hook first, the call is released immediately. If the calling line goes on-hook first and does not reanswer, the connection is not released until the called line goes on-hook. There are no time-outs, and the calling party is allowed to reanswer until the called line goes on-hook. Calls to lines with option ESG must have CALLCTRL(CALLED). Calls terminating on an ITOPS position must have CALLCTRL(CALLED). • If the entry is CALLING and the calling line goes on-hook first, the call is released immediately. If the called line goes on-hook first, the called party is allowed to reanswer within a datafilled reanswer time-out or until the calling line goes on-hook. If the time-out expires or if the calling line goes on-hook, the calling party releases the call and the called line is set to idle. • If the entry is LAST, the call is released when the later of the called party or the calling party goes on-hook. If either party goes on-hook, that party is allowed to reanswer within a datafilled reanswer time-out or until both parties go on-hook. • If the entry is MUTUAL and either line goes on-hook, the call is released immediately.
	CDNNAME	alphanumeric string	<p>Called number name. If the entry in subfield OSEL is SETCDN, enter data for this refinement to route the call using the called number name from table CDNCHAR.</p>

AMHEAD (continued)**Field descriptions for conditional datafill (Sheet 9 of 15)**

Field	Subfield or refinement	Entry	Explanation and action
	CHG	SEND_ CHARGE or SEND_NO_ CHARGE	Charge. If the entry in subfield OSEL is TOC, enter SEND_CHARGE to set the answer message (BTUP ANM) type of answer (TOA) string sent out from a node to SEND_CHARGE. Enter SEND_NO_CHARGE to set the answer message (BTUP ANM) type of answer (TOA) string sent out from a node to SEND_NO_CHARGE.
	CICSIZE	1 to 4	CIC size. If the entry in subfield OSEL is EXTCIC, enter data for this refinement. This field indicates the number of digits in the CIC. This field operates on the B (called) number, so it is assumed that the switch signals the CIC as part of the B number. The MAP display indicates the range is 0 to 4. The system does not allow a 0 entry.

AMHEAD (continued)

Field descriptions for conditional datafill (Sheet 10 of 15)

Field	Subfield or refinement	Entry	Explanation and action
	CLASS	ATT, CNTL, COLL, DATT, EMRG, IAGRP, ICNTL, INTL, IOPRA, LCL, NATL, OPRA, RURAL, SPEC, UNKW, or URBAN	<p>Translation class. If the entry in subfield OSEL is CLASS, enter the translation class determined by the dialed digits. This can be used for screening or billing as described under CLASS in screening and charging options.</p> <p>The translation classes are defined as follows:</p> <ul style="list-style-type: none"> • ATT (attendant console) • CNTL (continental) • COLL (collect) • DATT (dial attendant) • EMRG (emergency) • IAGRP (interagent group) • ICNTL (intercontinental) • INTL (international) • IOPRA (international operator assisted) • LCL (local) • NATL (national) • OPRA (operator assisted) • RURAL (rural) • SPEC (special) • UNKW (unknown) • URBAN (urban)
	CLDFMT	CURRENT, POSTXLA	<p>Called format. If the entry in subfield OSEL is CAMA, enter either CURRENT or POSTXLA to produce the required ICAMA record format.</p> <p>If the entry is CURRENT, an ICAMA record is produced with the signaled DN (without translation).</p> <p>If the entry is POSTXLA, an ICAMA record is produced with a PSTN number resulting from translations.</p>

AMHEAD (continued)**Field descriptions for conditional datafill (Sheet 11 of 15)**

Field	Subfield or refinement	Entry	Explanation and action
	CONDIGS	numeric (0 to 29 digits)	Consumed digits. If the entry in subfield OSEL is CONSUME, datafill this refinement. Enter a number to explicitly define the number of digits consumed during call processing.
	CONTINUE	CONT, NOCONT	Continue. If the entry in subfield OSEL is PRESEL, enter data for this refinement. Enter CONT to continue with the current translations system. Enter NOCONT to stop translations.
	CPMCALL	Y or N	Called party metering. If the entry in subfield OSEL is CPMCALL, enter Y (yes) if calls are billed against the called party for intraoffice calls. Enter N (no) for the default value of billing against the calling party for intraoffice calls.
	DDIDX	1 to 63 or DEFAULT	Destination discount index. If the entry in subfield OSEL is DDIDX, enter data for this refinement to apply the destination discount to the call.
	DEST	0 to 1023	Destination route list index. If the entry in subfield OSEL is DEST, enter the number in the route list, of the same translation system, that the call is routed to.
	IAA_INDEX	0 to 1024	Interadministration accounting index. If the entry in subfield OSEL is IAA, datafill this refinement. Enter the value that indexes the corresponding tuple in IACTRL.
	LNET	alphanumeric (1 to 16 characters)	Logical network. If the entry in subfield OSEL is LNET, enter the logical network name that the call is on. The logical network name must be previously datafilled in table LNETWORK. The entry in this field is used by the international metering system to determine a tariff for the call.

AMHEAD (continued)**Field descriptions for conditional datafill (Sheet 12 of 15)**

Field	Subfield or refinement	Entry	Explanation and action
	MAX	0 to 30	Maximum digits. If the entry in subfield OSEL is MM, datafill this refinement. Enter the maximum number of digits expected. This value includes the digits used to index the current tuple and must also include the prefix digits specified in the current tuple.
	MIN	0 to 30	Minimum digits. If the entry in subfield OSEL is MM, datafill this refinement. Enter the minimum number of digits expected. This value includes the digits used to index the current tuple and must also include the prefix digits specified in the current tuple.
	MZONE	0 to 63	Metering zone. If the entry in subfield OSEL is MZONE, enter the metering zone of the call, in the logical network as defined by selector LNET. The entry in this field is used by the international metering system to determine a tariff for the call.

AMHEAD (continued)**Field descriptions for conditional datafill (Sheet 13 of 15)**

Field	Subfield or refinement	Entry	Explanation and action
	NETSRV_ NAME	IPHS, DPHS, MOBILE, DA, TELEGRAM, or NCC	<p>Network service name. If the entry in subfield OSEL is NETSRV, datafill this refinement. The entry in this field determines the parameters in an outgoing IAM message.</p> <p>Enter IPHS to indicate a call to an independent personal handyphone system subscriber.</p> <p>Enter DPHS to indicate a call to a dependent personal handyphone system subscriber.</p> <p>Enter MOBILE to indicate a call to a mobile subscriber.</p> <p>Enter DA to indicate a call to the directory assistance operator.</p> <p>Enter TELEGRAM to indicate a call to the Telegram office.</p> <p>Enter NCC to indicate a call routed to one of the following networks:</p> <ul style="list-style-type: none"> • New Common Carrier serving international toll traffic • New Common Carrier serving national toll traffic
	NOA	INTL, LOCAL, NATL, or NET	<p>Nature of address. Enter the required called party nature of address.</p> <ul style="list-style-type: none"> • INTL (international) • LOCAL (local) • NATL (national) • NET (Intelligent Network Services)

AMHEAD (continued)**Field descriptions for conditional datafill (Sheet 14 of 15)**

Field	Subfield or refinement	Entry	Explanation and action
	ONNET	Y or N	<p>Call on virtual private network. If the entry in subfield OSEL is VPN, enter Y if the call stays within the defined virtual private network. Otherwise enter N.</p> <p>Overlapped outpulsing is only supported on off-network calls. Calls processed without subfield ONNET set to Y are off-network calls. Meridian Digital Centrex (MDC) calls are treated as off-network calls, and therefore overlapped outpulsing is supported for MDC calls.</p>
	PCCDR	0 to 9, B, C, D, E (1 to 3 digits)	<p>Pseudo country code digits. If the entry in subfield OSEL is PCC, enter the three-digit pseudo country code (PCC). If a two-digit PCC is required, it must be padded by a leading zero.</p> <p>The pseudo country code is used to record a particular pseudo country code. This can be extracted for use by system logic later, for example, two-stage outpulsing.</p>
	PFDIGS	0 to 24	<p>Number of prefix digits. If the entry in subfield OSEL is PF, datafill this refinement. Enter the number of prefix digits. If prefix digits are identified in a previous table, this number is added to the existing value. Prefix digits are not used to index any further translation tables and are not outpulsed, but they remain stored in call detail records (CDR).</p> <p>Note: If refinements PF and CONSUME are both datafilled for the same tuple, only the entry for the greater of the two values is processed; the other entry is ignored.</p>
	PFXAMA	0 to 4 digits, or N	<p>Called party number prefix in AMA. If NOA is set to NTL, datafill PFXAMA with 0011.</p> <p>If NOA is set to NATL, datafill PFXAMA with 0.</p> <p>If NOA is set to LOCAL or NET, datafill PFXAMA with N.</p>

AMHEAD (continued)**Field descriptions for conditional datafill (Sheet 15 of 15)**

Field	Subfield or refinement	Entry	Explanation and action
	PRIVL	Y or N	Privileged user. If the entry in subfield OSEL is PRIVL, enter Y (yes), if the user is a privileged user (for example, operator). Otherwise, enter N (no).
	SKIPDIGS	0 to 24	Skip digits. If the entry in subfield OSEL is EXTCIC, enter data for this refinement. This field indicates the number of digits to skip before removing the carrier digits from the digit stream. This field operates on the B (called) number, so it is assumed that the system signals the CIC as part of the B number.
	SOURCE	PRESUB or DIALED	Carrier identification code source. If the entry in subfield OSEL is EXTCIC, enter data for this refinement. This field specifies the source of the CIC as follows: <ul style="list-style-type: none"> • PRESUB - presubscribed. Table TRKGRP contains the definition of the CIC. • DIALED - dialed. The subscriber enters the CIC when dialing a call.
	STOPRTMR	Y or N	Stop remote timer. Enter Y (yes) to disable the address complete message (ACM) timer of the remote switch. Default is N (no).
	XLAID	FREE, GENERIC1, GENERIC2, or GENERIC3	AMA translation identifier. If the entry in subfield OSEL is AMAXLAID, enter the AMA translation identifier to be used against table AMAXLAID.

XLASEL = TRMT

If the entry in subfield XLASEL is TRMT, datafill the following refinements.

AMHEAD (continued)

Route to the specified treatment. A treatment is a known exception or failure condition. The action taken terminates translation, returning an indication that a treatment was encountered and decoded into a route.

Field descriptions for conditional datafill

Field	Subfield or refinement	Entry	Explanation and action
	OPT	see subfield	Options. This field is a vector consisting of up to ten options. Each option consists of subfield OSEL, and refinements that depend on the entry in subfield OSEL. For each option, specify the option selector (OSEL), followed by a space, and the refinements, each separated by a space. The entry is concluded by a \$ and datafill continues with field DFOP.
	OSEL	OFC	Option selector. Enter OFC, followed by a space, and datafill refinement OFC, if a treatment name is required.
	OFC	alphanumeric (1 to 4 characters)	Office treatment. Enter a treatment name that is contained in the office treatment subtable, TMTCNTL.TREAT.

XLASEL = all entries

Table AMAXLAID must be datafilled prior to selecting option AMAXLAID in field OSEL.

AMHEAD (continued)

For all entries in subfield XLASEL, datafill the following refinements.

Field descriptions for conditional datafill (Sheet 1 of 16)

Field	Subfield or refinement	Entry	Explanation and action
	DFOP	DFOP or NODFOP	<p>Default options . Enter DFOP and datafill subfield OSEL and its refinements.</p> <p>The default options only apply if a tuple with field XLASEL set to RTE or CONT is chosen in code table.</p> <p>If the entry in field DFOP is equal to DFOP, this field is a vector that consists of a number of options. Each option, consisting of subfield OSEL and refinements dependent on the entry in subfield OSEL, is separated from the next by a space. The various refinements are described in subfield OSEL. For each option, specify the option selector, followed by a space, and the refinements, with each refinement separated from the next by a space. The entry is concluded by a \$ and datafill continues with field CON.</p> <p>Enter NODFOP if there are no default options and datafill field CON.</p> <p>In the case of the dialed digits resolving into an RTE or CONT selector, any options not datafilled against the digits can be defaulted to the value specified here. This facility, and option DFLT, are intended to minimize the amount of datafill required in any given code table, especially if most of the expected codes have the same attributes. If an option is applicable to most, but not all, tuples in the code table instance, the option can still be datafilled in the default options. Options datafilled in the code table tuples override the options in the head table, so the different value can be datafilled into those few code tuples to which the default option does not apply.</p>
	DFOP (continued)		

AMHEAD (continued)**Field descriptions for conditional datafill (Sheet 2 of 16)**

Field	Subfield or refinement	Entry	Explanation and action
	OSEL	ACF, AMAXLAID, CALLCTRL, CAMA, CDN, CDNRTE, CLASS, CLIOVRD, CONSUME, CPCRTE, CPMCALL, DDIDX, DEST, EXTCIC, IAA, LNET, MM, MZONE, NETSRV, PCC, PF, PNRF, PRESEL, PRIVL, QFT, SETCDN, TELETAXE, TOC, VPN, or XLT	<p>Option selector. The following options can be selected:</p> <p>Enter ACF, followed by a space, and datafill refinement ACF if the area code fence is defined.</p> <p>Enter AMAXLAID, followed by a space, and datafill refinement XLAID to specify an automatic message accounting (AMA) identity from within table AMAXLAID.</p> <p>Enter CALLCTRL, followed by a space, and datafill refinement CALLCTRL. The entry in refinement CALLCTRL indicates who has control of the call: the calling party, the called party, or both.</p> <p>Enter CAMA, followed by a space, and datafill refinement CLDFMT. The entry in CLDFMT indicates whether the international automatic message accounting (ICAMA) record is generated with the the originally signaled directory number (DN) or the final public switched telephone network (PSTN) number.</p> <p>Enter CDN, followed by a space, and datafill refinement CDN to select the nature of address field. This field is used to identify the called party of the initial address message (IAM). It is used for Australian ISDN user part (AISUP) call translations.</p> <p>Enter CDNRTE to route a call using the called number name (CDNNAME) from table CDNCHAR. If the CDNNAME is present on the incoming call or is set by the SETCDN option, translation proceeds to table CDNUXLA. The CDNRTE option does not have refinements.</p> <p>Enter CLASS, followed by a space, and datafill refinement CLASS if the class of the dialed digits can be determined.</p>

AMHEAD (continued)**Field descriptions for conditional datafill (Sheet 3 of 16)**

Field	Subfield or refinement	Entry	Explanation and action
	<p data-bbox="444 583 581 642">OSEL (continued)</p>		<p data-bbox="867 464 1398 554">Enter CLIOVRD, followed by a space, and enter data for refinement CLIOVRD. This subfield indicates calling line identity override.</p> <p data-bbox="867 583 1382 705">Enter CONSUME, followed by a space, and datafill refinement CONDIGS to specify the number of digits that are consumed during translation.</p> <p data-bbox="867 735 1393 921">Enter CPCRTE to route the call using the calling party category (CPCNAME) from table CPCCHAR. If the CPCNAME is present on the incoming call, translation proceeds to table CPCUXLA. The CPCRTE option does not have refinements.</p> <p data-bbox="867 951 1382 1066">Enter CPMCALL, followed by a space, and datafill refinement CPMCALL to specify call billing against the called party instead of the calling party for intraoffice calls.</p> <p data-bbox="867 1096 1393 1218">Enter DDIDX, followed by a space, and enter data for refinement DDIDX. This option indicates a destination discount applies to the call.</p> <p data-bbox="867 1247 1393 1299">Enter DEST, followed by a space, and datafill refinement DEST if the destination is known.</p> <p data-bbox="867 1329 1386 1505">Enter EXTCIC, followed by a space, and enter data for refinements CICSIZE, SKIPDIGS, and SOURCE. The EXTCIC option indicates the external carrier identification code. This option is supported for TOPS calls.</p> <p data-bbox="867 1535 1370 1682">Enter IAA, followed by a space, and enter data for refinement IAA_INDEX. The IAA option generates or modifies IAA message parameters based on datafill in table IAACtrl.</p> <p data-bbox="867 1711 1393 1833">Enter LNET, followed by a space, and enter data for refinement LNET. Enter data for this option if the system requires a logical network for metering.</p>

AMHEAD (continued)

Field descriptions for conditional datafill (Sheet 4 of 16)

Field	Subfield or refinement	Entry	Explanation and action
			<p>Enter MM, followed by a space, and datafill refinements MIN and MAX if the minimum and maximum dialed digits are known.</p> <p>Enter MZONE, followed by a space, and datafill refinement MZONE if metering is to be done on the call.</p> <p>Enter NETSRV and datafill refinement NETSRV_NAME to indicate a Japan network service.</p> <p>Enter MM, followed by a space, and datafill refinements MIN and MAX if the minimum and maximum dialed digits are known.</p> <p>Enter MZONE, followed by a space, and datafill refinement MZONE if metering is to be done on the call.</p> <p>Enter NETSRV and datafill refinement NETSRV_NAME to indicate a Japan network service.</p> <p>Enter OSS to indicate operator signaling services. This subfield does not have refinements.</p> <p>Enter PCC, followed by a space, and datafill refinement PCCDR if a pseudo country code is required.</p> <p>Enter PF, followed by a space, and datafill refinement PFDIGS if there are prefix digits in the digit stream.</p> <p>Enter PNRF to invoke the ported number recognition function. LNP applications in Germany use the PRNF. The PNRF option does not have refinements.</p>

AMHEAD (continued)

Field descriptions for conditional datafill (Sheet 5 of 16)

Field	Subfield or refinement	Entry	Explanation and action
			<p>Enter PRESEL, followed by a space, and datafill refinement PRESEL to provide the necessary information used to index into the PCIXLA table.</p> <p>Enter PRIVL, followed by a space, and datafill refinement PRIVL if the user is a privileged user (for example, operators).</p> <p>Enter QFT followed by ON or OFF to indicate if an outgoing route is capable of QSIG feature transparency.</p> <p>Note: Operating company personnel must not add the QFT ON option to a route unless the far-end node is QFT-capable.</p> <p>Enter SETCDN, followed by a space, and enter data for refinement CDNNAME. The SETCDN option assigns the called number name (CDNNAME) from table CDNCHAR to the call.</p> <p>Enter TELETAXE. This option does not have refinements.</p> <p>Enter TOC, followed by a space, and datafill refinement CHG for the type of charge if the type of charge messaging is selected.</p> <p>Enter VPN, followed by a space, and datafill refinements ONNET and BILLABLE if the call routes through a service switching point (SSP) and feature package NTXH49AA or NTXH49AB (VPN-SSP) is in the switching unit.</p> <p>Enter XLT, followed by a space, and datafill refinement XLASYS if the call is to proceed to another translation system.</p>
	ACF	0 to 29	<p>Area code fence. If the entry in subfield OSEL is ACF, datafill this refinement. Enter the number of digits between the beginning of the digits to currently index the table, and the end of the area code.</p>

AMHEAD (continued)**Field descriptions for conditional datafill (Sheet 6 of 16)**

Field	Subfield or refinement	Entry	Explanation and action
	BILLABLE	Y or N	Virtual private network billable call. If the entry in subfield OSEL is VPN, datafill this refinement. Enter Y if an AMA record is required for each VPN call. Otherwise, enter N. An AMA record is not generated if an address complete message (ACM) of address complete, no charge is returned, or if the call terminates in the SSP on a line with the free number terminating (FNT) option.
	CALLCLASS	PRESELECT OVERRIDE, CSN, or TRUNK	<p>Preselection call processing. If the entry in subfield OSEL is PRESEL, datafill this refinement. Enter the preselection call class type that is associated with the call.</p> <p>Note: Calltype CSN and TRUNK are available under the PRESEL option. These call classes are not needed for German Carrier Selection, and are not supported. The same applies to the Continue option of CONT. For the German market, only NOCONT is supported.</p>

AMHEAD (continued)**Field descriptions for conditional datafill (Sheet 7 of 16)**

Field	Subfield or refinement	Entry	Explanation and action
	CALLCTRL	CALLED, CALLING, or MUTUAL	<p>Call control. If the entry in subfield OSEL is CALLCTRL, enter one of the following three values to specify the party that has control of the call:</p> <ul style="list-style-type: none"> • If the entry is CALLED and the called line goes on-hook first, the call is released immediately. If the calling line goes on-hook first and does not reanswer, the connection is not released until the called line goes on-hook. There are no time-outs, and the calling party is allowed to reanswer until the called line goes on-hook. <p>Calls to lines with option ESG must have CALLCTRL(CALLED).</p> <p>Calls terminating on an ITOPS position must have CALLCTRL(CALLED).</p> <ul style="list-style-type: none"> • If the entry is CALLING and the calling line goes on-hook first, the call is released immediately. If the called line goes on-hook first, the called party is allowed to reanswer within a datafilled reanswer time-out or until the calling line goes on-hook. If the time-out expires or if the calling line goes on-hook, the calling party releases the call and the called line is set to idle. • If the entry is MUTUAL and either line goes on-hook, the call is released immediately.
	CDNNAME	alphanumeric string	<p>Called number name. If the entry in subfield OSEL is SETCDN, enter data for refinement CDNNAME.</p>

AMHEAD (continued)**Field descriptions for conditional datafill (Sheet 8 of 16)**

Field	Subfield or refinement	Entry	Explanation and action
	CHG	SEND_ CHARGE or SEND_NO_ CHARGE	Charge. If the entry in subfield OSEL is TOC, datafill this refinement. Enter SEND_CHARGE to set the answer message (BTUP ANM) type of answer (TOA) string sent out from a node to SEND_CHARGE. Enter SEND_NO_CHARGE to set the answer message (BTUP ANM) type of answer (TOA) string sent out from a node to SEND_NO_CHARGE.
	CICSIZE	1 to 4	CIC size. If the entry in subfield OSEL is EXTCIC, enter data for this refinement. This field indicates the number of digits in the CIC. This field operates on the B (called) number, so it is assumed that the system signals the CIC as part of the B number. The MAP display indicates the range is 0 to 4. The system does not allow an entry of 0.

AMHEAD (continued)**Field descriptions for conditional datafill (Sheet 9 of 16)**

Field	Subfield or refinement	Entry	Explanation and action
	CLASS	ATT, CNTL, COLL, DATT, EMRG, IAGRP, ICNTL, INTL, IOPRA, LCL, NATL, OPRA, RURAL, SPEC, or UNKW	<p>Translation class. If the entry in subfield OSEL is CLASS, datafill this refinement. Enter the translation class determined by the dialed digits. This can be used for screening or billing purposes as described under CLASS in screening and charging options.</p> <ul style="list-style-type: none"> • ATT (attendant console) • CNTL (continental) • COLL (collect) • DATT (dial attendant) • EMRG (emergency) • IAGRP (interagent group) • ICNTL (intercontinental) • INTL (international) • LCL (local) • IOPRA (international operator assisted) • NATL (national) • OPRA (operator assisted) • RURAL (rural) • SPEC (special) • UNKW (unknown)
	CLDFMT	CURRENT or POSTXLA	<p>Called format. If the entry in subfield OSEL is CAMA, enter either CURRENT or POSTXLA to produce the required ICAMA record format.</p> <p>If the entry is CURRENT, an ICAMA record is produced with the signaled DN (without translation).</p> <p>If the entry is POSTXLA, an ICAMA record is produced with public switched telephone network (PSTN) number resulting from translations.</p>

AMHEAD (continued)**Field descriptions for conditional datafill (Sheet 10 of 16)**

Field	Subfield or refinement	Entry	Explanation and action
	CLIOVRD	CNA, CNB	Calling line identity override. If the entry in subfield OSEL is CLIOVRD, enter data for refinement CLIOVRD. Enter CNA to allow the calling number for each call. Enter CNB to block the calling number for each call.
	CONDIGS	numeric (0 to 29 digits)	Consumed digits. If the entry in subfield OSEL is CONSUME, datafill this refinement. Enter a number to explicitly define the number of digits consumed during call processing.
	CONTINUE	CON or NOCON	<p>Consume digits. The default options only apply if a tuple with field XLASEL set to CONT or DMOD is chosen in the code tables.</p> <p>The default case is not to consume digits (that is, the next table is indexed using the same digits as the current table, except for ignoring prefix digits). However, under certain conditions, the next table is indexed starting with the digits following the index to the current table (in other words, translations absorb or consume the current index digits). An example of this is when an area code is found in table FACODE. Table OFCCODE is indexed with the digits following the area code (the office code), so the digits used to index table FACODE are consumed. Note that this does not mean that the digits are deleted from the digit register. They are still there, and are outpulsed unless explicitly deleted in the code or route tables. The CON option only means that they are not used to index the next table.</p> <p>Enter CON and translation consumes the current index digits, if the next table is indexed starting with the digits following the index to the current table. Consume does not mean that the digits are deleted from the digit register, they remain there and are outpulsed unless explicitly deleted in the code or route tables. Option CON only means that the digits used to index the current table are not used to index the next table.</p>

AMHEAD (continued)

Field descriptions for conditional datafill (Sheet 11 of 16)

Field	Subfield or refinement	Entry	Explanation and action
	CONTINUE (continued)	CON or NOCON	<p>Enter NOCON if digits are not to be consumed (the next table is indexed using the same digits as the current table, except the prefix digits).</p> <p>Note: To suppress the consumption of digits contained in field CONDIGS of code table AMCODE enter NOCON, which will cause any to-be-consumed digits contained in field CONDIGS to be ignored. It is not necessary to remove the digits contained in field CONDIGS of code table AMCODE to suppress the consumption of these digits.</p>
	CPMCALL	Y or N	<p>Called party metering. If the entry in subfield OSEL is CPMCALL, datafill this refinement. Enter Y (yes) if calls are billed against the called party for intraoffice calls. Enter N (no) for the default value of billing against the calling party for intraoffice calls.</p>
	DDIDX	1 to 63 or DEFAULT	<p>Destination discount index. If the entry in subfield OSEL is DDIDX, enter data for this refinement. Enter the destination discount index number.</p>
	DEST	0 to 1023	<p>Destination route list index. If the entry in subfield OSEL is DEST, datafill this refinement. Enter the number in the route list, of the same translation system, that the call is routed to.</p>
	IAA_INDEX	0 to 1024	<p>Interadmission accounting index. If the entry in subfield OSEL is IAA, enter data for this refinement. Enter the value that indexes the corresponding tuple in table IAACRL.</p>

AMHEAD (continued)**Field descriptions for conditional datafill (Sheet 12 of 16)**

Field	Subfield or refinement	Entry	Explanation and action
	LNET	alphanumeric (1 to 8 characters)	Logical network. If the entry in subfield OSEL is LNET, enter data for this refinement. This refinement specifies the name of the logical network that carries the call. Table LNETWORK must already have the logical network. The international metering system uses the entry in this field to determine the tariff for the call.
	MAXIDX	C, F, and STD or 9	<p>Maximum index. Enter C if the translation tables are to be indexed by dialed digits hexadecimal B (*) and hexadecimal C (#) in addition to digits in the range 0 to 9.</p> <p>Enter F if the translation tables are to be indexed by dialed digits in the range 0 to 9, and hex digits B, C, D, E, and F.</p> <p>Enter STD or 9 if the translation tables are to be indexed by dialed digits in the range 0 to 9. The default entry is 9.</p>
	MAX	0 to 30	Maximum digits. If the entry in subfield OSEL is MM, datafill this refinement. Enter the maximum number of digits expected. This value includes the digits used to index the current tuple and must also include the prefix digits specified in the current tuple.
	MIN	0 to 30	Minimum digits. If the entry in subfield OSEL is MM, datafill this refinement. Enter the minimum number of digits expected. This value includes the digits used to index the current tuple and must also include the prefix digits specified in the current tuple.
	MZONE	0 to 63	Metering zone. If the entry in subfield OSEL is MZONE, datafill this refinement. Enter the metering zone of the call, in the logical network as defined by selector LNET. The entry in this field is used by the international metering system to determine a tariff for the call.

AMHEAD (continued)**Field descriptions for conditional datafill (Sheet 13 of 16)**

Field	Subfield or refinement	Entry	Explanation and action
	NETSRV_ NAME	IPHS, DPHS, MOBILE, DA, TELEGRAM, or NCC	<p>Network service name. If the entry in subfield OSEL is NETSRV, datafill this refinement. The entry in this field determines the parameters in an outgoing IAM message.</p> <p>Enter IPHS to indicate a call to an independent personal handyphone system subscriber.</p> <p>Enter DPHS to indicate a call to a dependent personal handyphone system subscriber.</p> <p>Enter MOBILE to indicate a call to a mobile subscriber.</p> <p>Enter DA to indicate a call to the directory assistance operator.</p> <p>Enter TELEGRAM to indicate a call to the Telegram office.</p> <p>Enter NCC to indicate a call routed to one of the following networks:</p> <ul style="list-style-type: none"> • New Common Carrier serving international toll traffic • New Common Carrier serving national toll traffic
	NOA	INTL, LOCAL, NATL, or NET	<p>Called nature of address parameter. If the entry in subfield OSEL is CDN, datafill this refinement. Enter the required called party nature of address.</p> <p>If the called party is an international number, enter INTL. If the called party is a local number, enter LOCAL. If the called party is a national number, enter NATL. If the called party subscribes to Intelligent Network Services, enter NET.</p>

AMHEAD (continued)

Field descriptions for conditional datafill (Sheet 14 of 16)

Field	Subfield or refinement	Entry	Explanation and action
	ONNET	Y or N	<p>Call on virtual private network. If the entry in subfield OSEL is VPN, datafill this refinement. Enter Y (yes) if the call stays within the defined virtual private network. Otherwise, enter N (no).</p> <p>Overlapped outpulsing is only supported on off-network calls. Calls processed without the ONNET subfield set to Y are off-network calls. Meridian Digital Centrex (MDC) calls are treated as off-network calls, and therefore overlapped outpulsing is supported for MDC calls.</p>
	PCCDR	0 to 9, B, C, D, E (1 to 3 digits)	<p>Pseudo country code digits. If the entry in subfield OSEL is PCC, datafill this refinement. Enter the three-digit pseudo country code (PCC). If a two-digit PCC is required, it must be padded by a leading zero.</p> <p>The pseudo country code is used to record a particular pseudo country code. This can be extracted for use by system logic later, for example, two-stage outpulsing.</p>
	PFDIGS	0 to 24	<p>Number of prefix digits. If the entry in subfield OSEL is PF, datafill this refinement. Enter the number of prefix digits. If prefix digits are identified in a previous table, this number is added to the existing value. Prefix digits are not used to index any further translation tables and are not outpulsed, but they remain stored in call detail records (CDR).</p> <p>Note: If refinements PF and CONSUME are both datafilled for the same tuple, only the entry for the greater of the two values is processed; the other entry is ignored.</p>
	PFXAMA	0 to 4 digits or N	<p>Called party number prefix in AMA. If NOA is set to NTL, enter 0011 in PFXAMA.</p> <p>If NOA is set to NATL, enter 0 in PFXAMA.</p> <p>If NOA is set to LOCAL or NET, enter N in PFXAMA.</p>

AMHEAD (continued)**Field descriptions for conditional datafill (Sheet 15 of 16)**

Field	Subfield or refinement	Entry	Explanation and action
	PRIVL	Y or N	Privileged user. If the entry in subfield OSEL is PRIVL, datafill this refinement. Enter Y (yes), if the user is a privileged user (for example, operator). Otherwise, enter N (no).
	SKIPDIGS	0 to 24	Skip digits. If the entry in subfield OSEL is EXTCIC, enter data for this refinement. This field indicates the number of digits to skip before removing the carrier digits from the digit stream. This field operates on the B (called) number, so it is assumed that the system signals the CIC as part of the B number.
	SOURCE	PRESUB or DIALED	Carrier identification code source. If the entry in subfield OSEL is EXTCIC, enter data for this refinement. This field specifies the source of the CIC as follows: <ul style="list-style-type: none"> • PRESUB - presubscribed. Table TRKGRP defines the CIC. • DIALED - dialed. The subscriber enters the CIC when dialing a call.
	STOPRTMR	Y or N	Stop remote timer. Enter Y (yes) to disable the address complete message (ACM) timer of the remote switch. The default value is N (no).
	XLAID	FREE, GENERIC1, GENERIC2, or GENERIC3	AMA translation identifier. If the entry in subfield OSEL is AMAXLAID, datafill this refinement. Enter the AMA translation identifier to be used against table AMAXLAID.

AMHEAD (continued)**Field descriptions for conditional datafill (Sheet 16 of 16)**

Field	Subfield or refinement	Entry	Explanation and action
	XLASYS	AC, AM, CT, DN, FA, FT, NSC, OFC, PX	<p>Translation system. If subfield OSEL is set to XLT, datafill this refinement. Enter the next translation system to use, followed by a space, then datafill refinement XLANAME.</p> <ul style="list-style-type: none"> • AC (access) • AM (ambiguous) • CT (country) • DN (directory number) • FA (foreign area) • FT (utility) • NSC (number service code) • OFC (office) • PX (prefix) <p>Note: NIL is not a valid entry. NIL is only used to satisfy internal software functionality.</p>
	XLANAME	alphanumeric (1 to 8 characters)	<p>Translation name. If the entry in subfield OSEL is XLT, datafill this refinement. Enter the translation name of the table instance within the XLASYS that the call is routed to.</p>

Datafill example

An example of datafill for subtable OFC234 is shown below.

Subtable AM234 is referenced. The dialed digits are 234-727-1364.

Since more digits were dialed than for a local call, the route is changed. Default options apply with selector RTE, so the default options are taken from table OFCHEAD tuple with subfield XLANAME value OFC234. The destination reference given in the AMCODE tuple applies to the fourth route list in subtable OFC234 of table OFCRTE. Note that class NATL and DEST 4 in table AMCODE override class LCL and DEST 2 in table OFCCODE. It is necessary to refer to table AMCODE after a destination was found because it can change depending on the number of digits dialed.

If no ambiguous code tuple is selected, the entry in field DFLT from tuple AM234 in table AMHEAD is used.

AMHEAD (continued)

Although the AMCODE result says that if there are eight or more digits, the call is routed to destination 4, option MM in table OFCHEAD says that a maximum of ten digits are allowed. If more than ten digits are dialed, the call is not routed. Option MM takes precedence over the ambiguous code table results. Note that care must be taken that they do not conflict, but rather that MM provides a boundary for the ambiguous code results.

MAP display example for table OFCHEAD

XLANAME	DFLT
CON MAXIDX	DFOP
<hr/>	
OFC234	SDFLT
DFOP (MM 6 10) \$	
NOCON 9	

MAP display example for table AMHEAD

XLANAME	DFLT
<hr/>	
OFC234 234 235	
CONT (XLT AM AM234) (DEST 2) (CLASS LCL) \$	

MAP display example for table OFCRTE

XLANAME	RTEREF	RTELIST
<hr/>		
OFC234	2	
		(N LOCALCLLI DEL 3 PFXDIGS 09)\$
OFC234	4	
		(S NEXTOWN)\$

AMHEAD (continued)

MAP display example for table AMHEAD

XLANAME	DFLT
AM234	SDFLT

MAP display example for table AMHEAD

XLANAME	DFLT
AM234	8 GE
RTE (DEST 4) (CLASS NATL) \$	

Table history

APC010

Added field TLC_CHARGE to option TLC in the FEATINFO selector.

APC009

Added option NETSRV to selectors CONT and RTE.

Added option JES to selector FEATINFO.

APC008.1

The following updates were introduced in APC008.1 to table AMHEAD:

- Field CHKCCR was added to all subscriber types (SUBSCTYP) that are part of the SUBSCRN option of selector FEATINFO VALIDATE.
- Field EARLYCPG was added to selector FEATINFO.
- Option IAA was added to selectors ROUTE and CONT.

GL04

Provided the ability to datafill FLEXCHG in the RTE and CONT selectors.

Provided the ability to datafill CHGIND in the RTE and CONT selectors.

Provided the ability to datafill ISUPPREF in the RTE and CONT selectors.

AMHEAD (continued)

GL003

The following updates were introduced in GL03 to table AMHEAD:

- Provided the ability to datafill ACF in RTE and CONT selectors.
- Provided the ability to datafill CAMA in RTE, CONT, and DNRTE selectors.
- Added URBAN to selector CLASS.
- Applied effectivity to GL03 specific sections.

NA005

The following updates were introduced to table AMHEAD in NA005:

- increased the number for universal translations support to 30 digits, affecting the following options, subfields or selectors:
 - ACF
 - AFTER
 - CONSUME
 - DEL
 - DMOD
 - DNRTE
 - INSRT
 - MAX
 - MIN
 - PF
 - REPL
- added option SF and its refinement SFDIGS to selector DNRTE.
- added note about potential conflict with refinements CONSUME and PFDIGS

APC006

Subscriber type PERSONAL added to option SUBSCRN of FEATINFO VALIDATE.

APC004

Subfield CDN of selectors CONT and RTE was modified to incorporate subfields NOA, STOPRTMR, and PFXAMA.

AMHEAD (end)

BCS35

The following option and refinement were added:

- option CGNDM with refinements PRDFXCLI and INSRTCLI
- refinement CPMCALL to XLASELs CONT and RTE

ANISCRNU

Table name

Automatic Number Identification (ANI) Screening for FGB (ANISCRNU) table

Functional description

Table ANISCRNU permits a call originating on an FGB off-network access trunk (ONAT) trunk group to be blocked or allowed based on seven-digit ANI digits. ANI digits identify the call originator. The digit format is NXX-XXXX. The NXX means a valid exchange, and XXXX represents the destination digits.

The ANISCRNU table lists the seven-digit ANIs to be blocked. The table is indexed according to the ONAT trunk group table parameter, ASCRNIDX. ASCRNIDX ranges from 0 to 20. If ASCRNIDX equals 0, ANI screening is not performed. If the ASCRNIDX value equals one or more, use the value to index table ANISCRNU.

The ANISCRNU table contains up to 500 seven-digit numbers to be blocked for each of the 20 indices. If a subscriber uses one of the ANIs listed in this table, the call processing blocks the call and returns the ANI FGB blockage treatment (ANBB treatment code).

If call processing accesses the ANISCRNU table with an ANI screening index without ANI digits to block datafill, no log or other informational output is produced, since this could be a normal condition. The access procedure simply returns false, indicating the call processes. If call processing attempts screening with fewer than seven ANI digits, an OCC222 log generates.

Table size

The maximum size for table ANISCRNU is 20 indices \times 500 (7-digit ANIs) = 10,000 tuples.

Memory requirements

The algorithm for data store memory allocation is as follows:

63 words overhead + $[((\# \text{ entries divided by } 125)+1)] \times 125 \times 2$ words

ANISCRNU (end)

Field descriptions

The following table describes field names, subfield names, and valid data ranges for table ANISCRNU.

Field	Subfield or refinement	Entry	Explanation and action
INDXNANI		see subfields	INDEX NUMBER FOR AUTOMATIC NUMBER IDENTIFICATION DIGITS. Datafill the two-part key consisting of: ANIINDEX and ANITOBK.
	ANIINDEX	1 to 20	AUTOMATIC NUMBER IDENTIFICATION DIGITS INDEX. Enter the ANI index filed against the originating FGB (ONAT) trunk group, field ASCRNIDX. A value of 0 in the ONAT trunk group parameter ASCRNIDX indicates that ANI screening is not required.
	ANITOBK	7 digits (0 to 9)	AUTOMATIC NUMBER IDENTIFICATION DIGITS TO BLOCK. List the 7-digit ANI (in NXX-XXXX format) disallowed as originating ANI over an FGB trunk group. Note: Define up to 500 7-digit numbers for each index specified, for a total of 10,000 7-digit ANIs.

Datafill example

The following example shows datafill for table ANISCRNU.

```

INDXNANI
-----
1  4242121
1  5551212
    
```

ANISCUSP

Table name

Automatic Numbering Identification (ANI) Screening Customer Profile (ANISCUSP) table

Functional description

Table ANISCUSP contains the ANI verification database for calls originating over FGD and PANI trunk groups (DAL, FGA, FGB, and FGD). It is datafilled so that calls can proceed at the NPA, NPA-NXX, or NPA-NXX-XXXX level (where NPA is a valid area code, NXX is a valid exchange, and XXXX are the destination digits) of the ANI.

The ANISCUSP table provides the following capabilities:

- allows all calls to proceed when the ANI contains a specific NPA

Note: The failure to find any entries for the NPA of the ANI causes the call to be blocked.

- allows calls to proceed when the ANI contains an NPA only
- screens up to 6 digits on a 10-digit ANI
- allows or blocks calls for a specific 10-digit ANI (NPA-NXX-XXXX) based on the combination of features associated with the ANI spill

An attempt to verify a 10-digit ANI that has not been entered into this table returns the table to the STATUS field associated with the ANI at the NPA-NXX level. However, if the STATUS field is not datafilled for that NPA-NXX, then the STATUS from the NPA level returns. If there is no data present at the NPA level either, a log generates and the call routes to ANI Database Failure treatment (ADBF).

Table size

A minimum of 0 tuples and a maximum of 160 NPA tuples are statically allocated.

Memory requirements

Memory allocates dynamically for each NPA, up to 800 NXXs. For each NXX up to 10,000 XXXXs are dynamically allocated.

Datafill sequence and implications

Datafill table CAINGRP before datafilling the CAINGRP option of the OPTION vector.

ANISCUSP (continued)

Datafill CDR templates in table CDRTMPLT before datafilling the CDRTMPLT option.

Field descriptions

The following table describes field names, subfield names, and valid data ranges for table ANISCUSP.

Field	Subfield or refinement	Entry	Explanation and action
KEY		Up to 18 alphanumeric characters (0 to 9, B to F, N)	KEY. Enter a 3-digit ANI, with NPA format, when field ANITYPE=NPA. Enter a 6-digit ANI, with NPA-NXX format, when field ANITYPE=NXX. Enter a 10-digit ANI, with NPA-NXX-XXXX format, when field ANITYPE=SUB.
ANITYPE		NPA NXX SUB	AUTOMATIC NUMBER IDENTIFICATION TYPE. Identifies the ANI type. <ul style="list-style-type: none"> • Enter NPA when the KEY contains a 3-digit ANI. See section ANITYPE=NPA or NXX for refinement data. • Enter NXX when the KEY contains a 6-digit ANI. See section ANITYPE=NPA or NXX for refinement data. • Enter SUB when the KEY contains a 10-digit ANI. See section ANITYPE=SUB for refinement data.
REFAR EA			REFINEMENT AREA. Refer to the ANITYPE=NPA or NXX section for NPA and NXX REFAREA refinement datafill. Refer to the ANITYPE=SUB section for SUB REFAREA refinement datafill.

ANISCUSP (continued)**ANITYPE=NPA or NXX**

When ANITYPE=NPA or NXX, datafill the following refinements:

Refinement	Subfield or refinement	Entry	Explanation and action
STATUS		CA DA NA	<p>STATUS. For ANIs validated on an NPA or NPA-NXX level, enter one of the following codes that describes the status of the calling party:</p> <ul style="list-style-type: none"> • Enter CA when the call processes based on the presence of the FGD trunk group option CASUALU. If the option is not present on the trunk, then the call routes to treatment. If the option is present the call is allowed to proceed. • Enter DA when 10-digit ANI represents a subscriber being disallowed access to the network. • Enter NA when ANI is not assigned.
BCNAME		Valid BC datafilled in table BCDEF	<p>BEARER CAPABILITY NAME. Enter a bearer capability defined in table BCDEF. There is no default.</p>

ANISCUSP (continued)

ANITYPE=SUB

When ANITYPE=SUB, datafill the following refinements:

(Sheet 1 of 4)

Refinement	Subfield or refinement	Entry	Explanation and action
STATUS		CA AL DA RD	<p>Enter one of the following:</p> <ul style="list-style-type: none"> • Enter CA when the call processes based on the presence of the FGD trunk group option CASUALU. If the option is not present on the trunk, then the call routes to treatment. If the option is present the call is allowed to proceed. • Enter AL when calls originating with the specified 10-digit ANI are allowed to proceed. • Enter DA when 10-digit ANI represents a subscriber being disallowed access to the network. • Enter RD when 10-digit ANI defined represents a subscriber who has been recently disallowed access to the network. <p>Note: If status of ANI digits defined is DA (Disallowed) or RD (Recently Disallowed), the switch routes the call to ADBF treatment.</p>
ACCTLEN		0 to 12	ACCOUNT CODE LENGTH. Enter the number of digits the system is to collect for the account code. If the subscriber is not required to dial an account code, enter 0.
ACCTVAL		Y or N	ACCOUNT CODE VALIDATION. This field indicates whether account code validation is required. Enter Y if account code validation is required. Enter N if account code validation is not required.
BCNAME		Valid BC datafilled in table BCDEF	BEARER CAPABILITY NAME. Enter a bearer capability defined in table BCDEF. There is no default.
OPART		0 to 999	ORIGINATING PARTITION NUMBER. Enter an originating partition (OPART) number.

ANISCUSP (continued)

(Sheet 2 of 4)

Refinement	Subfield or refinement	Entry	Explanation and action
TERMPART		0 to 31	TERMINATING PARTITION NUMBER. When ANIDIGS field identifies a 10-digit ANI, enter the terminating partition number associated with the subscriber that is translated to a serving translation scheme (STS) for off-net calling.
SATREST		Y or N	SATELLITE RESTRICTED. This field allows the operating company to designate which ANIs are restricted from satellite switching. Enter one of the following: <ul style="list-style-type: none"> • Y when calls associated with this ANI are restricted from satellite switching • N when calls associated with this ANI are allowed satellite switching
PINLEN		0, 2, or 3	PERSONAL IDENTIFICATION NUMBER LENGTH. This field identifies the number of personal identification number (PIN) digits to collect from the originating subscriber for the ANI number. The default value is 0, and indicates there are no multiple PIN digits.
PININDEX		0 to 8191	PERSONAL IDENTIFICATION NUMBER INDEX. This field identifies the index into the MULTIPIN table for validating received PIN digits. The default value is 0, which indicates there are no multiple PINs.
PINDIGS		0 to 4 digits (0 to 9, A to D)	PERSONAL IDENTIFICATION NUMBER DIGITS. PIN digits are used to further identify authorized users of the system. Enter up to 4 characters in length with a combination of 0-9 and/or A-D (fourth column DTMF digits). Enter \$ when PIN digits are not required, or when multiple PINs are being defined via table MULTIPIN fields PINLEN and PININDEX. This is an optional field.

ANISCUSP (continued)

(Sheet 3 of 4)

Refinement	Subfield or refinement	Entry	Explanation and action
MLTCOSID		0 to 2047	MULTIPLE CLASS OF SERVICE (COS) INDEX. This field indexes into table MULTICOS to indirectly point to table COSUS. The default value is 0 to indicate no COS screening is performed. With table MULTICOS, a single MLTCOSID can contain up to 32 COSUS indexes, and therefore COS screening can be performed up to 32 times per call.
ANIDELV			ACCOUNT NUMBER IDENTIFICATION DELIVERY. This field controls the delivery of ANI for FGD and PRI CLID-billed originations. This field is only used for 10-digit ANIs.
		ALWAYS	ALWAYS - For ISUP, deliver the CPN and CGN and OLI. For PTS, deliver the ANI. For PRI, deliver the CLID.
		NEVER	NEVER - Do not deliver anything
		CPNONLY	CPNONLY - For ISUP, deliver only the CPN. For PTS, deliver the ANI. For PRI, deliver the CLID.
		CGNONLY	CGNONLY - For ISUP, deliver only the CGN and OLI. For PTS, deliver the ANI. For PRI, deliver nothing.
OPTION			OPTION. This field consists of subfields that can be datafilled as necessary.
		ACCTIDX	Enter ACCTIDX to enable this option. Datafill the ACCTIDX refinement. Note: Datafill this option only when the VALIDATE_ACCT_DMS250 office parameter and the ACCTVAL field are set to Y.
	ACCTIDX	0 to 4294967295	ACCOUNT INDEX. Enter a number between 0 and 4294967295 to index table ACSCRN2. Enter 0 to disable the ACCTIDX option.
		OPCHOICE	Enter OPCHOICE to provide alternate routing for operator service calls. This option is only available for 0- or 0+ calls. Datafill the OPCHIDX refinement.

ANISCUSP (continued)

(Sheet 4 of 4)

Refinement	Subfield or refinement	Entry	Explanation and action
	OPCHIDX	0 to 1023	Enter a number between 0 and 1023 to index table OPCHOICE.
		CAINGRP	CAIN GROUP. Enter CAINGRP to specify a CAIN subscription group for the ANI. Datafill the CAINGRP refinement.
	CAINGRP	Valid CAIN group datafilled in table CAINGRP	CAIN GROUP. Enter a valid CAIN group datafilled in table CAINGRP. The ANI subscribes to CAIN services through the CAIN group.
		PASSTHRU	PASSTHRU. This option identifies the particular FGD call types using this ANI number where the PASSTHRU feature is active. Datafill the PASSTHRU refinement.
	PASSTHRU	PURE_ONLY, CUT_ONLY, PURE_CUT	PASSTHRU. The valid values are: <ul style="list-style-type: none"> • PURE_ONLY. Identifies that only pure-FGD calls originating with this ANI number use the PASSTHRU feature. • CUT_ONLY. Identifies that only cut-through FGD calls originating with this ANI number use the PASSTHRU feature. • PURE_CUT. Identifies that both pure-FGD and cut-through FGD calls originating with this ANI number use the PASSTHRU feature.
		CDRTMPLT	CDR TEMPLATE. Use this option to identify the CDR template used to generate CDRs for the specified ANI. Refer to the OPTION=CDRTMPLT section for refinement datafill.

ANISCUSP (continued)**OPTION=CDRTMPLT**

When OPTION=CDRTMPLT, datafill the TMPLTIDX and USEEDIT refinements.

Refinement	Subfield or refinement	Entry	Explanation and action
TMPLTIDX		Valid name datafilled in table CDRTMPLT	TEMPLATE INDEX. When SOC option UBFR0001 is enabled, you can use table CDRTMPLT to create new CDR template. For more information on CDR templates, see <i>UCS DMS-250 Billing Records Application Guide</i> .
USEEDIT		N or Y	USE EDIT. Enter N to use the active version of the CDR template. Y indicates that the edit version is used. Note: This field is used for testing purposes only. It should be set to N, which is the default.

Datafill example

The following example shows datafill for table ANISCUSP.

```
KEY ANITYPE REFAREA
```

```
2026112211 SUB CA 0 N 3_1KHZ 111 0 N 0 0 $ 0 CGNONLY (CDRTMPLT)
2025111221 SUB CA 1 N 3_1KHZ 555 0 N 0 0 1 0 CGNONLY $
```

Table history**UCS13**

Removed UCS07 and UCS07FLEX values from table OPTION=CDRTMPLT (A60007776).

UCS11

The OPCHIDX field is updated. The maximum number of entries is expanded to 1023. (A60006449).

UCS09

The table was updated with the CDRTMPLT option (AX1248).

UCS06

Updated to support the following enhancements:

- new MULTICOS table
- Billing Server (flexible CDR)

ANIVAL

Table name

Automatic Numbering Identification Validation (ANIVAL) table

Functional description

Table ANIVAL contains a list of the valid ANIs for calls originating over FGD and PANI trunk groups. Each entry also contains a link to the appropriate profile for that ANI in table UNIPROF.

Datafill sequence and implications

You must enter datafill for table UNIPROF before table ANIVAL.

You must datafill table MULTPROF before the field PROFTYPE can be set to MULT in table ANIVAL.

Table size

0 to 6,400,640,800 tuples occupying 0 to 25,620,488 Kbytes

The amount of memory taken can be estimated with: $8000 \text{ bytes} + (25600 \text{ bytes} * A) + (4 \text{ bytes} * B)$ where A is the number of unique NPA-Nzz's for 6- or 10- digit ANIs and B is the number of 10-digit ANIs.

Datafill

The following table lists datafill for table ANIVAL.

Field descriptions

Field	Subfield or refinement	Entry	Explanation and action
ANIKEY		up to 18 alphanumeric characters(0 to 9, B to F, N)	KEY. Enter a 3-, 6-, or 10- digit ANI. Use 3 digits when PROFIDX corresponds to a tuple with a UNITYPE of NPA. Use 6 digits when PROFIDX corresponds to a tuple with a UNITYPE of NXX. Use 10 digits when PROFIDX corresponds to a tuple with a UNITYPE of SUB.
PROFTYPE		UNI, MULT	PROFILE TYPE. The default value for PROFTYPE is UNI. Value MULT allows table ANIVAL to use table MULTPROF to obtain multiple profiles for an ANI for each CIC.
PROFIDX		vector of up to 8 characters	PROFILE INDEX. Enter the index to table UNIPROF.

Datafill example

The following example shows sample datafill for table ANIVAL.

MAP display example for table ANIVAL

ANIKEY	PROFTYPE	REFAREA
214	UNI	UNIKEY1
214444	UNI	UNIKEY2
2142221234	UNI	UNIKEY3
9725554321	MULT	MULTPRF2
2146667890	MULT	MULTPRF2
9725561234	MULT	MULTPRF6

Table history**UCS08**

The PROFTYPE field is updated to include the MULT entry.

UCS07

Table ANIVAL is created.

Supplementary information

ANIs are not screened by this table unless the ANI_SCREENING_ORDER office parameter is set to either ANIVAL, ANISCUSP_ANIVAL, or ANIVAL_ANISCUSP.

ANNMEMS

ATTENTION

This table applies to new or modified content for SN09 (DMS) that is valid through the current release.

Mapping members to announcements

Table Announcement Members (ANNMEMS) provides members for each announcement group that appears in table ANNS and maps the member to a peripheral.

For DRAM or AUDICHRON types, each member designates a physical voice channel where the announcements will be played.

For UAS type, each member provides the mapping between the announcement to an Audio Node.

The number of call forwarding announcement (CFRA) members must be equal to the office parameter MAX_PROGRAMMERS in table OFCENG. The number must be equal to make sure that every CFRA call can allocate a channel to the digital recorded announcement machine (DRAM). If the allocation of the announcement channel cannot occur, the CFRA call fails.

Datafill sequence and meaning

For DRAM operation, entry of the following tables must occur before table ANNMEMS:

- ANNS
- DRAMS
- CLLI
- TMINV

For the Audio Node, entry of the following tables must occur before table ANNMEMS:

- SERVSINV
- SERVRINV
- ANNS

Entry of one or more of the following tables must occur after table ANNMEMS:

- AUDIO
- CLLIMITCE
- CUSTANNS
- CUSTHEAD
- ANNPHLST
- NSCANNS
- OFRT
- OFR2
- OFR3
- OFR4
- OSSANNS
- RESOFC
- TRKGRP

Table size

The system continuously allocates memory for table ANNMEMS.

Table ANNMEMS can have a maximum of 255 tuples for each tuple in table ANNS. The maximum size of table ANNMEMS is normally 65 025. The maximum size of table ANNMEMS can be 521 985. This maximum size occurs if feature package XN26AA (announcement enhancements) or X983AB (Service Switching Point Private Virtual Networking) is in the load.

Datafill

The table below describes datafill entries for table ANNMEMS.

Table ANNMEMS field descriptions

Field	Subfield or refinement	Entry	Explanation and action
ANNMEM		see subfields	<i>Announcement member key.</i> This field contains subfields ANN and MEMBER.
	ANN	alphanumeric	<i>Announcement.</i> Enter the CLLI that represents the announcement group in table ANNS.

Table ANNMEMS field descriptions (Continued)

Field	Subfield or refinement	Entry	Explanation and action
	MEMBER	0 to 255	<i>Member.</i> If the trunk circuit is the first in the trunk list for the announcement member, enter the number assigned to the member.
HDWTYPE		AUDICHRON, DRAM, or UAS	<i>Hardware type.</i> Enter AUDICHRON if the first entry for the member and hardware type is analog. Enter DRAM if the recorded announcement member is digital. Enter UAS to support the Audio Server for the Call Server 2000 (CS 2000). When the HDWTYPE is UAS, enter field CARD and subfield PMTYPE with the entry AUD.
CARD		2X72AA 2X72AB 2X72AC 2X88AA, DRA, AUD	<i>Card code.</i> Enter the card code if the trunk member is analog. Enter DRA if the trunk member is digital. A trunk circuit contains a trunk circuit on a trunk card if a switching unit has an analog recorded announcement machine. The trunk card has product engineering code NT2X72AA, AB, or AC, or NT2X88AA on a TM8 trunk module type. Enter AUD for the CARD to support the Audio Server for the CS2000.
MEMINFO		see subfields	<i>Memory information.</i>
MEMINFO for HDWTYPE = DRAM or AUDICHRON			
When HDWTYPE = DRAM or AUDICHRON, MEMINFO has the single subfield TRCKLIST. TRCKLIST itself has subfields as detailed below.			
	TRCKLIST	see subfields	<i>Track list.</i> This field contains subfields TRACK, PMTYPE, TMNO, and TMCKT.

Table ANNMEMS field descriptions (Continued)

Field	Subfield or refinement	Entry	Explanation and action
	TRACK	0 to 31	<p><i>Track number.</i> Enter the track number assigned to the trunk circuit.</p> <p>If the announcement is multilingual, each language must be assigned to a different track (trunk circuit).</p> <p>The sequence list for the tracks in the announcement member trunk list determines the order that the listener hears the tracks. For example, if a member has three tracks in the following sequence 1, 5, and 3, the listener hears track 1 first. The listener hears track 5 next. The listener hears track 3 last.</p> <p>If announcements are bilingual, the track assigned to the priority language is the first track assigned in the member trunk list.</p>
	PMTYPE	ATM, DTM, MTM, MTMA, PTM, RMM, RSM, STM, TAN, TMA, TM2, TM4, TM8, T8A	<p><i>Peripheral module type.</i> Enter the type of peripheral module that has the trunk circuit assigned.</p> <p>If the announcement member is digital, enter maintenance trunk module (MTM) or service trunk module (STM).</p> <p>If the announcement member is analog, enter TM8.</p> <p>If the announcement member connects to an EDRAM (1X80), enter DTM.</p>

Table ANNMEMS field descriptions (Continued)

Field	Subfield or refinement	Entry	Explanation and action
			<p>In the occurrence of Mechanized Calling Card service (MCCS), the announcement channels are not for any specified announcement. In the occurrence of standard recorded announcements, announcement channels are for specified announcements. Instead, MCCS is present as a group in table ANNS. The group includes members in table ANNMEMS. The members associate with a maximum of 29 MTM dedicated channels on a specified digital recorded announcement machine (DRAM). Channel 0 is reserved for diagnostic purposes. Normally, a whole DRAM is dedicated as an MCCS machine. Any of the MCCS announcements can play back through any one channel. This play back can occur because the Traffic Operator Position System (TOPS) must have immediate connection to the MCCS announcements. A caller receives an audible ring from the MCCS announcements while the caller waits to hear an announcement.</p>

Table ANNMEMS field descriptions (Continued)

Field	Subfield or refinement	Entry	Explanation and action										
	TMNO	0 to 2047	<p><i>Trunk module number.</i> Enter the trunk module number assigned to the trunk module that has the trunk circuit assigned.</p> <p>If trunk module type is MTM, the range is 0 to 255.</p> <p>If the trunk type is TM8, STM or DTM, the range is 0 to 2047.</p> <p>If the switching unit has a DRAM, a trunk circuit contains an assignment to a trunk circuit (channel). The circuit can be on the maintenance trunk module (MTM) or on the Service Trunk Module (STM). The DRAM is on the STM. A trunk circuit cannot be assigned to trunk module circuit number 0 (zero) because this circuit is for the DRAM controller.</p>										
	TMCKT	0 to 29	<p><i>Trunk module circuit number.</i> Enter the trunk module circuit number that has the trunk circuit assigned.</p> <p>For MTMs, the DRAM can have configuration to function as an 8, 16, 24 or 30 trunk circuit interface. The configuration depends on the dip switch settings on the controller card. Four dip switches are present on the controller card. The dip switches enable the number of circuits that appear below:</p> <table border="0"> <tr> <td>Switch setting</td> <td>Trunk circuits enabled</td> </tr> <tr> <td>None</td> <td>1 to 7</td> </tr> <tr> <td>3</td> <td>8 to 15</td> </tr> <tr> <td>2</td> <td>16 to 23</td> </tr> <tr> <td>4</td> <td>24 to 29</td> </tr> </table>	Switch setting	Trunk circuits enabled	None	1 to 7	3	8 to 15	2	16 to 23	4	24 to 29
Switch setting	Trunk circuits enabled												
None	1 to 7												
3	8 to 15												
2	16 to 23												
4	24 to 29												

Table ANNMEMS field descriptions (Continued)

Field	Subfield or refinement	Entry	Explanation and action						
			<p><i>Note:</i> Circuits 1 to 7 are permanently enabled. These circuits do not have switch setting.</p> <p>For STMs, dip switches can enable only 15 circuits. The DRAM controller switch setting and associated circuit number assignments for STMs appear below:</p> <table> <tr> <td>Switch setting</td> <td>Trunk circuits enabled</td> </tr> <tr> <td>None</td> <td>1 to 7</td> </tr> <tr> <td>3</td> <td>8 to 15</td> </tr> </table> <p>One trunk circuit is necessary for each announcement track assigned to the announcement member.</p> <p>All trunk circuits assigned to an announcement member must be on the same trunk module.</p> <p>For DTM, use of all channels can occur. Switches that must be set are not present.</p>	Switch setting	Trunk circuits enabled	None	1 to 7	3	8 to 15
Switch setting	Trunk circuits enabled								
None	1 to 7								
3	8 to 15								
			<p>MEMINFO for HDWTYPE = UAS</p> <p>When HDWTYPE = UAS, MEMINFO has subfields PHLSTIDX, PMTYPE, and AUDNO.</p>						
	PHLSTIDX	0 to 255	<p>Phrase list index. Enter the phrase list that corresponds to phrase index in table ANNPHLST.</p> <p>Note: For custom announcement members with hardware type UAS, the PHLSTIDX field is ignored. This field is present for all members datafilled with HDWTYPE UAS, but it is consulted only if the announcement CLLI is datafilled as STND in table ANNS.</p>						

Table ANNMEMS field descriptions (Continued)

Field	Subfield or refinement	Entry	Explanation and action
	PMTYPE	AUD	<i>Peripheral module type.</i> Enter the type of peripheral module that has the trunk circuit assigned. Enter AUD for Audio Server (UAS). Enter the subfield AUDNO.
	AUDNO	0 to 255	<i>Audio number.</i> Enter AUDNO for the PMTYPE of AUD.

Datafill example

For broadcast announcements on a Audio Node, only one member can be datafilled per node. Custom announcements are datafilled to be per-connection but for those on an Audio Node, it is recommended that all the members on the same node be datafilled continuously after one another. This provides the most efficient method of selection for custom announcement members (see example below).

The figure below shows sample datafill for table ANNMEMS. The first two lines are for a broadcast announcement on an Audio Node. Only one member per node allowed.

The second two lines are for a custom announcement on an Audio Node. Members 0 and 1 reside on node 0 and are datafilled consecutively. Member 2 is on node 1 and should be datafilled next if there are to be no more connections to be datafilled on node 0. This is the recommended datafill for most effective selection of a custom announcement member.

The last line is for a DRAM announcement.

MAP display example for table ANNMEMS

ANNMEM	HDWTYPE	CARD	MEMINFO
BLDNANN	0	UAS	AUD 3 AUD 0
BLDNANN	1	UAS	AUD 4 AUD 1
CFRAANN	0	UAS	AUD 0 AUD 0
CFRAANN	1	UAS	AUD 0 AUD 0
CFRAANN	2	UAS	AUD 0 AUD 1
PSPD	1	DRAM	(1 STM 0 5) \$

Supplementary information

Packet announcement members (HDWTYPE = UAS) are not supported for custom announcements of type MDS or TOPSVR. If a UAS member is datafilled for an announcement that is datafilled in table ANNS with ANNTYPE = MDS or TOPSVR, one of the following warning messages is displayed:

- *Packet members are not supported for ANNTYPE MDS*
- *Packet members are not supported for ANNTYPE TOPSVR*

Table history**SN09 (DMS)**

Packet members cannot be datafilled for custom announcements of type TOPSVR or MDS owing to feature A00009013.

SN06 (DMS)

Changes for HDWTYPE = UAS due to feature A19013546:

- phrase list index (PHSLSTIDX) subfield added to MEMINFO fields.
- subfields VCIRCUIT and AUDID removed from MEMINFO field.

SN01

HDWTYPE = UAS introduced.

TL02

Table introduced.

ANNPHLST

ATTENTION

This table applies to new or modified content for SN09 (DMS) that is valid through the current release.

Table name

Announcement Phrase List

Functional description

Table ANNPHLST provides the phrase list for custom or broadcast announcements member in table ANNMEMS. Each ANNPHLST table entry provides the names of the phrases assigned to each track of an announcement member.

As of SN06, this new table takes the place of table DRAMTRK and DRMUSERS.

Use the digital recorded announcement machine (DRAM) recording utility (DRAMREC) to define phrases on DRAM facilities. These phrases are entered in table DRAMPHRS.

For announcements on an Audio Node, define phrases in table ANNAUDID.

Datafill sequence and meaning

Table ANNPHLST must be datafilled after ANNS and ANNMEMS.

For DRAM announcements datafill DRAMPHRS before ANNPHLST.

For announcements defined on an Audio Node datafill ANNAUDID before ANNPHLST.

Table size

Store is dynamically allocated. Minimum number of tuples is zero.

Datafill

The table that follows lists datafill for table ANNPHLST.

Field descriptions

Field	Subfield	Entry	Explanation and action
ANNPHKEY		see subfields	Announcement Phrase Key. This field has subfields CLLI and PHLSTIDX.
	CLLI	alphanumeric	Common Language Location Identifier. Enter an announcement CLLI found in table ANNS.
	PHLSTIDX	0 to 255	<p>Phrase List Index. Enter an index number depending on the type of announcement.</p> <p>For DRAM broadcast type, this number corresponds to a track index from the tracklist of the member tuple in table ANNMEMS.</p> <p>For broadcast announcement members with hardware type of UAS, this corresponds to the phrase list index field in table ANNMEMS.</p> <p>For all custom announcements, this value corresponds to a specific custom announcement index for that particular feature. See section on custom announcements.</p>
PHLIST		alphanumeric	Phrase List. Enter the phrase(s) available in table DRAMPHRS or ANNAUDID depending on whether the announcement is DRAM or UAS respectively. Can hold up to 32 phrases. For custom announcements, use the defined phrase names from the section on custom announcements.

Custom Announcements

The following features use custom announcements:

- Mechanized Calling Card Service (MCCS)
- Automatic Coin Toll Service (ACTS)
- Automatic Calling Card Service (ACCS)
- Call Forwarding Remote Access (CFRA)
- Custom Local Calling Area Signaling Services (CLASS)
- Notification of Time and Charge (NTC)
- Station Programmable PIN (SPP)
- Subscriber Activated Call Blocking (SACB)
- Capability Set 1 Revised (CS-1R) announcements
CS-1R Pre-Paid Services

Mechanized Calling Card Service

MCCS is a TOPS custom announcement type. Although the DMS250 also supports an MCCS application, that application uses standard announcements. This section applies to TOPS MCCS.

MCCS announcements can be provided by DRAMs or by packet-based media servers in a hybrid solution with IP and ENET fabrics. The Media Server 2010 (MS 2010) and the Universal Audio Server (UAS) are examples of media servers.

For DRAMs, MCCS announcements can take the form of prerecorded phrases on two NT1X76CA double density erasable programmable read-only memory (EPROM) cards. Alternatively, an operating company can record its own DRAM announcements for MCCS. Use the DRAMREC CI to define phrases on a DRAM. All MCCS announcements are single-track.

For packetized MCCS announcements, the operating company provides the recordings and provisions them on the media servers using the Announcement Provisioning Server (APS). After that, tables ANNAUDID, CLLI, ANNS, ANNMEMS, and ANNPHLST must also be datafilled in the CM.

MCCS provides no secondary language support in the CM. An operating company can provide bilingual MCCS announcements by recording the announcements in both languages. For DRAMs, since MCCS announcements are single-track, both languages must be recorded on the same track. For packetbased MCCS announcements, a sequence can be created using the APS.

In addition to basic calling card validation, the MCCS custom announcement type can be used for sequence call prompts and for the TOPS Authorization Code and Account Code Billing features.

MCCS pre-defines custom announcement numbers 1 through 9 and 15 through 23. It reserves 10 through 14 for future development. Through datafill in tables EAMCCSAN and/or MCCSNBEC, the operating company can specify that announcement numbers 24 and higher are to be used to brand the initial “thankyou” acknowledgment for correct card entry.

MCCS does not use any variable, or placeholder, phrase names. Nortel suggests, but does not require, that the operating company use phrase names shown in the table for MCCS announcements. The table shows the pre-defined MCCS announcement numbers and suggested content for each. The table shows the announcement numbers in an order that is logical in terms of call flow, rather than listing them in order by announcement number. The table uses the following abbreviations:

- Calling Card Validation (CCV)
- Sequence calling (SEQ)
- Account Billing Code (ACB)
- Authorization Code (AUTH)

Pre-defined MCCS announcements with suggested content

Pre-defined Announcement Number	When this Announcement is used	Suggested Phrase List	Suggested Content
17	Initial prompt for CCV and ACB if originating station treatment (OST) from table MCCSOST is TONE. Also used as the initial and retry prompt for AUTH.	MCCSENG 17	Alert tone (“bong”) for calling card dialing. This is a complex tone consisting of 60 ms DTMF #-tone (941/1477 Hz @ -10 dBm), followed immediately by 940 ms of exponentially decayed dial tone (440/350 Hz with time constant of 200 ms initially at -10 dBm)
18	Initial prompt for CCV and ACB if originating station treatment (OST) from table MCCSOST is TONEANN.	MCCSENG 17	
1	Re-prompt for CCV and ACB when initial prompt was announcement 18 (OST = TONEANN) and timeout occurred.	MCCSENG 1	Please dial your card number or zero for an operator now.
2	Re-prompt for CCV and ACB if caller entered an invalid card number (CCV) or invalid account code (ACB).	MCCSENG 2	Please dial your card number again now. The card number you have dialed is not valid.
19	Re-prompt when timeout occurs after caller has heard announcement 2.	MCCSENG 17	

Pre-defined MCCS announcements with suggested content

Pre-defined Announcement Number	When this Announcement is used	Suggested Phrase List	Suggested Content
3	Re-prompt when timeout occurs after caller has heard announcement 19.	MCCSENG 3	Please dial your card number.
9	Re-prompt when timeout occurs after caller has heard announcement 3.	MCCSENG 9	Please hang up and dial zero plus the number you are calling.
4	Sign-off message for CCV when caller has entered too many invalid card numbers.	MCCSENG 4	Please hang up and dial zero plus the number you are calling. (pause) The card number you have dialed is not valid.
16	Announcement played when card number (CCV) or account code (ACB) has been successfully validated.	MCCSENG 16	Thank you.
The following MCCS announcements are used for sequence calls.			
5	Prompt when # is entered, initiating a sequence call.	MCCSENG 5	You may dial another call now.
23	Re-prompt when timeout occurs after announcement 5.	MCCSENG 5	
20	Sign-off message when timeout occurs after announcement 23.	MCCSENG 9	

Pre-defined MCCS announcements with suggested content

Pre-defined Announcement Number	When this Announcement is used	Suggested Phrase List	Suggested Content
6	Re-prompt when caller enters an incorrect number in response to announcement 5.	MCCSENG 6	Please dial the number you are calling again now. The number you have dialed is not correct.
7	Re-prompt when timeout occurs after announcement 6.	MCCSENG 7	Please dial the number you are calling.
21	Sign-off announcement when timeout occurs after announcement 7.	MCCSENG 9	
8	Sign-off announcement when caller has entered too many incorrect numbers for a sequence call.	MCCSENG 8	Please hang up and dial zero plus the number you are calling. The number you have dialed is not correct.
15	The number dialed is restricted for sequence calling.	MCCSENG 15	Please hang up and dial direct. This number cannot be dialed as a sequence call.
22	Announcement played when caller has entered a correct number for a sequence call.	MCCSENG 16	
<p>Note 1: MCCS announcement numbers 10 through 14 are reserved for future development.</p> <p>Note 2: MCCS announcement numbers higher than 23 may be used to brand the initial thank-you acknowledgment by carrier or NBEC. The datafill for that is in tables EAMCCSAN and MCCSNBEC.</p>			

Note: for some phrases, the table above lists the same phrase name against several different announcement numbers or scenarios. The table shows the suggested content only once for each phrase name. The operating company can provision different phrases for some of the announcements that share the same phrase name in the table above. To do that,

- First record the new announcement on the DRAM(s) or provision it on the media servers.
- Then add datafill to table DRAMPHRS (using the DRAMREC CI) or ANNAUDID (manually) mapping a new phrase name defined by the operating company to the internal ID provisioned on the announcement server.
- Finally, datafill the new phrase in table ANNPHLST against the CLLI used for MCCS and the new MCCS announcement number.

Note: The table also shows a relatively inefficient scheme for using announcement store. It is based on the pre-recorded announcements that Nortel provides for DRAMs. If you do not plan to use these pre-recorded announcements, you may want to break out some of the sub-phrases that appear multiple times into their own phrases. For example, the sub-phrase “Please hang up and dial zero plus” appears in several different phrases. A separate recording could be created for that, and it could be included in the phrase lists for all of the announcements that begin that way.

If packet announcements are used for MCCS, the scheme for phrase names shown in Table 16 can be efficient if the media server is provisioned with audio sequences for the announcements that contain common phrases. The sequence identifier is then the one datafilled in table ANNPHLST.

If both DRAM and packet members are used for MCCS (or for any other custom announcement type), be aware that the two kinds of members share the same tuple in table ANNPHLST.

Automatic Coin Toll Service

ACTS is a TOPS custom announcement type that can be used for coin call automation and also for the TOPS Time and Charges, Non-coin Notification, and TOPS Coin Tone Generation Test features.

ACTS announcements can be provided by DRAMs or by packet-based media servers in a hybrid solution with IP and ENET fabrics. The Media Server 2010 (MS 2010) and the Universal Audio Server (UAS) are examples of media servers.

For DRAMs, ACTS announcements can take the form of prerecorded phrases on circuit pack NT1X76AE. Alternatively, an operating company can record its own DRAM announcements for ACTS. Use the DRAMREC CI to define the phrases on a DRAM. All ACTS announcements are single-track.

For packetized ACTS announcements, the operating company provides the recordings and provisions them on the media servers using the Announcement Provisioning Server (APS). After that, tables ANNAUDID, CLLI, ANNS, ANNMEMS, and ANNPHLST must also be datafilled in the CM.

ACTS provides no secondary language support.

ACTS pre-defines custom announcement numbers 1 through 23. Through datafill in tables SPIDDB, EAACTSAN and/or ACTSNBEC, the operating company can specify that announcement numbers 24 and higher are to be used to customize the initial correct deposit and overdeposit “thank-you” acknowledgments for coin calls by Service Provider ID, interLATA carrier, or Non-Bell Exchange Company.

ACTS defines certain placeholder phrase names that are datafilled in table ANNPHLST but should not be datafilled in either DRAMPHRS or ANNAUDID. The following table shows the ACTS pre-defined placeholder phrase names.

Placeholder phrase name	Meaning
ACTS_VAR_CHARGE	Amount of money due
ACTS_VAR_CREDIT	Amount of credit from overdeposit
ACTS_VAR_PERIOD	Time duration for charges or for notification
ACTS_VAR_COIN	Denomination of coin to be deposited for coin test feature

In addition to the placeholder phrases, Nortel recommends, but does not require, that the operating company use certain other phrase names for ACTS. These are shown in the following tables. Those phrase names are added to table DRAMPHRS (using the DRAMREC

CI) or ANNAUDID (manually, after provisioning the media servers) before they are datafilled in table ANNPHLST.

The following table shows the pre-defined ACTS announcement numbers, the scenario in which each is used, and the suggested phrase list for each. The table shows the announcement numbers in an order that is logical in terms of call flow, rather than listing them in order by announcement number.

Pre-defined ACTS announcements with suggested phrase lists

Pre-defined announcement number	When this announcement is used	Suggested phrase list (PHLIST field of table ANNPHLST)
1	Initial deposit request	(ACTS_VAR_CHARGE) (ACTS_PLEASE) (ACTS_PAUSE) (ACTS_PLS_DEPOSIT) (ACTS_VAR_CHARGE) (ACTS_FOR_FIRST) (ACTS_VAR_PERIOD)
2	Re-prompt on timeout after announcement 1, no coins entered	(ACTS_PLS_DEPOSIT) (ACTS_VAR_CHARGE)
3	Inter-coin prompt - Re-prompt after inter-coin timeout for initial period	(ACTS_PLS_DEPOSIT) (ACTS_VAR_CHARGE) (ACTS_MORE)
4	Acknowledgement of correct deposit for initial period	(ACTS_THANK_YOU)
5	Acknowledgement of an overdeposit for initial period	(ACTS_THANK_HAVE) (ACTS_VAR_CREDIT) (ACTS_CR_OVERTIME)
6	Notification at end of initial period, for post-paid overtime	(ACTS_ALERT) (ACTS_VAR_PERIOD) (ACTS_END_SIGNAL)

Pre-defined ACTS announcements with suggested phrase lists

Pre-defined announcement number	When this announcement is used	Suggested phrase list (PHLIST field of table ANNPHLST)
7	Charge due deposit request, post-pay, with no previous overdeposit	(ACTS_ALERT) (ACTS_VAR_CHARGE) (ACTS_PLEASE) (ACTS_PAUSE) (ACTS_PLS_DEPOSIT) (ACTS_VAR_CHARGE) (ACTS_FOR_PAST) (ACTS_VAR_PERIOD)
14	Re-prompt on timeout after announcement 7	(ACTS_PLS_DEPOSIT) (ACTS_VAR_CHARGE)
8	Charge due deposit request post-pay, with previous overdeposit	(ACTS_ALERT) (ACTS_VAR_CHARGE) (ACTS_PLEASE) (ACTS_PAUSE) (ACTS_YOU_HAVE) (ACTS_VAR_CREDIT) (ACTS_CREDIT) (ACTS_PLS_DEPOSIT) (ACTS_VAR_CHARGE) (ACTS_MORE) (ACTS_FOR_PAST) (ACTS_VAR_PERIOD)
15	Re-prompt on timeout after prompt 8.	(ACTS_PLS_DEPOSIT) (ACTS_VAR_CHARGE)
20	Charge due deposit request pre-pay, with previous overdeposit	(ACTS_ALERT) (ACTS_VAR_CHARGE) (ACTS_PLEASE) (ACTS_PAUSE) (ACTS_PLS_DEPOSIT) (ACTS_VAR_CHARGE) (ACTS_FOR_NEXT) (ACTS_VAR_PERIOD)
22	Re-prompt on timeout after prompt 20.	(ACTS_PLS_DEPOSIT) (ACTS_VAR_CHARGE)

Pre-defined ACTS announcements with suggested phrase lists

Pre-defined announcement number	When this announcement is used	Suggested phrase list (PHLIST field of table ANNPHLST)
21	First overtime charge prompt, pre-pay, with previous overdeposit.	(ACTS_ALERT) (ACTS_VAR_CHARGE) (ACTS_PLEASE) (ACTS_PAUSE) (ACTS_YOU_HAVE) (ACTS_VAR_CREDIT) (ACTS_CREDIT) (ACTS_PLS_DEPOSIT) (ACTS_VAR_CHARGE) (ACTS_MORE) (ACTS_FOR_NEXT) (ACTS_PERIOD)
23	Re-prompt on timeout after prompt 21.	(ACTS_PLS_DEPOSIT) (ACTS_VAR_CHARGE)
16	Overtime inter-coin prompt (pre-pay or post-pay).	(ACTS_PLS_DEPOSIT) (ACTS_VAR_CHARGE) (ACTS_MORE)
17	Acknowledgement of correct deposit for overtime period (pre-pay or post-pay)	(ACTS_THANK_YOU)
18	Acknowledgement of overdeposit for overtime period (pre-pay or post-pay)	(ACTS_THANK_YOU) (ACTS_VAR_CREDIT) (ACTS_CR_OVERTIME)
9	Time and charges quotation.	(ACTS_ALERT) (ACTS_CHARGES_ARE) (ACTS_VAR_CHARGE) (ACTS_PLUS_TAX) (ACTS_VAR_PERIOD)
19	Repeat time and charges quotation (timeout after announcement 9).	(ACTS_ALERT) (ACTS_CHARGES_ARE) (ACTS_VAR_CHARGE) (ACTS_PLUS_TAX) (ACTS_VAR_PERIOD)
10	Non-coin, customer-requested notification of time.	(ACTS_ALERT) (ACTS_VAR_PERIOD) (ACTS_HAS_ENDED)

Pre-defined ACTS announcements with suggested phrase lists

Pre-defined announcement number	When this announcement is used	Suggested phrase list (PHLIST field of table ANNPHLST)
11	Coin test prompt.	(ACTS_PLS_DEPOSIT) (ACTS_1) (ACTS_VAR_COIN)
12	Coin test failure, also coin test cycle done.	(ACTS_PAUSE) (ACTS_ALERT)
13	Coin test success.	(ACTS_THANK_YOU) (ACTS_VAR_COIN) (ACTS_TST_ENDED)

You do not have to use the exact phrase lists that are suggested in the table above, but it is important that placeholder phrases be datafilled only for the announcements for which they make sense and are shown in the table. For example, it would be an error to datafill placeholder phrase ACTS_VAR_CREDIT in announcement 1, the initial deposit request.

One reason you might want to define your own phrase names would be to play a different “thank-you” acknowledgment for announcement 4 than for announcement 17. To provision different announcements:

- First record the new announcement on the DRAM(s) or provision it on the media servers.
- Then add datafill to table DRAMPHRS (using the DRAMREC CI) or ANNAUDID (manually) mapping a new phrase name defined by the operating company to the internal ID provisioned on the announcement server.
- Finally, datafill the new phrase in table ANNPHLST against the CLLI used for ACTS and the ACTS announcement number.

The following table shows the suggested content for the phrase names from the previous table. It does not include the placeholder phrase names, for which variable substitution occurs before the audio

identifiers are determined. It also does not include the pre-defined phrase names that are substituted for placeholder phrases.

Suggested content for ACTS phrases

Phrase name	Suggested phrase content
ACTS_ALERT	Alerting tone, recording as an announcement
ACTS_PLEASE	'please'
ACTS_PAUSE	two second pause
ACTS_PLS_DEPOSIT	'Please deposit'
ACTS_FOR_FIRST	'for the first'
ACTS_MORE	'more'
ACTS_THANK_YOU	'Thank you'
ACTS_THANK_HAVE	'Thank you. You have'
ACTS_CR_OVERTIME	'credit toward overtime'
ACTS_END_SIGNAL	'has ended. Please signal when through'
ACTS_FOR_PAST	'for the past'
ACTS_YOU_HAVE	'You have'
ACTS_CREDIT	'credit'
ACTS_CHARGES _ARE	'The charges are'
ACTS_PLUS_TAX	'plus tax for'
ACTS_HAS_ENDED	'has ended'
ACTS_1	'one'
ACTS_TST_ENDED	'test has ended'

Note: The ACTS phrases shown in the tables are not the complete list of phrases that must be present in table DRAMPHRS or

ANNAUDID to support ACTS. Tables DRAMPHRS (legacy) and ANNAUDID (packet) must also include certain phrases to support variable substitution. Variable substitution is done differently for packet announcements than for DRAM announcements. Section “Automatic Coin Toll Service” in *DMS-100 Family NA100 Translations Guide* lists all the phrases that must be provisioned on DRAMS if legacy announcements are used for ACTS, and these include the ones used for variable substitution. If packet announcements are used, refer to the section that describes ACTS in section *Configuring packet-based TOPS announcements*, that is documented in *DMS NA100 Family MMP Customer Data Schema Reference Manual*.

Automatic Calling Card Service

The DMS-200 switching unit for the ACCS feature in the Canadian market provides the following announcements.

The announcements are in English and French. The operating company can have entries so that DRAM reports the required announcements in one or two languages.

The DMS-200 selects a free DRAM channel. The DMS-200 delivers the correct announcement during an ACCS call.

Announcements 1 to 17 are standard announcements.
Announcements 17 to 25 are customized announcements.

The DRAM PROM memory cards 1X76AH, English, and 1X76BH, French, are in use.

Input for standard announcements appear in the following examples.

Announcement 1

An initial prompt announcement returns to a subscriber with the tone plus prompt announcement treatment.

ACCS announcement 1

Phrase name	Announcement
ACCSENG1	Please enter your calling card number or dial zero to reach an operator. This is a recording.
ACCSFRE1	Veillez entrer votre numéro de Carte d'appel ou faire le zéro pour joindre le téléphoniste. C'était un message enregistré.

Announcement 2

An error announcement returns to a subscriber that enters a rejected calling card number or makes a keying error.

ACCS announcement 2

Phrase name	Announcement
ACCSENG2	The card number received is not valid. Please enter your card number again.
ACCSFRE2	Le numéro de carte d'appel reçu n'est pas valide. Veuillez entrer à nouveau votre numéro de carte.

Announcement 3

A prompt announcement returns after an error occurs and the system gives the prompt tone.

ACCS announcement 3

Phrase name	Announcement
ACCSENG3	Please enter your card number.
ACCSFRE3	Veuillez entrer votre numéro de carte d'appel.

Announcement 4

A termination failure announcement returns when a subscriber reaches the threshold for keying error or rejected calling card number. The customer must hang up and originate the call again.

ACCS announcement 4

Phrase name	Announcement
ACCSENG4	The card number received is not valid. Please hang up, then dial zero and the number you are calling.
ACCSFRE4	Le numéro de Carte d'appel reçu n'est pas valide. Veuillez raccrocher, puis faire le zéro et composer le numéro que vous voulez joindre.

Announcement 5

A prompt announcement returns for a sequence call.

ACCS announcement 5

Phrase name	Announcement
ACCSENG5	You may place another call now.
ACCSFRE5	Vous pouvez maintenant faire un autre appel.

Announcement 6

An error announcement returns after errors occur in the called number for a sequence call.

ACCS announcement 6

Phrase name	Announcement
ACCSENG6	An incorrect number was dialed. Please redial the number you are calling.
ACCSFRE6	Le numéro que vous avez composé est inexact. Veuillez composer à nouveau le numéro que vous voulez joindre.

Announcement 7

A second error announcement returns when the following two conditions occur:

- the system gives an error announcement
- the subscriber does not enter a new called number for a sequence call

ACCS announcement 7

Phrase name	Announcement
ACCSENG7	Please dial the number you are calling.
ACCSFRE7	Veuillez composer le numéro que vous voulez joindre.

Announcement 8

A termination announcement returns when a subscriber reaches the threshold for a wrong called number in a sequence call.

ACCS announcement 8

Phrase name	Announcement
ACCSENG8	An incorrect number was dialed. Please hang up, then dial zero and the number you are calling.
ACCSFRE8	Le numéro que vous avez composé est inexact. Veuillez raccrocher, puis faire le zéro et composer le numéro que vous voulez joindre.

Announcement 9

A termination error announcement returns when the following two conditions occur:

- the system gives a prompt announcement
- the subscriber does not enter a new calling card number

The announcement applies to a called number for a sequence call.

ACCS announcement 9

Phrase name	Announcement
ACCSENG9	Please hang up, then dial zero and the number you are calling.
ACCSFRE9	Veillez raccrocher, puis faire le zéro et composer le numéro que vous voulez joindre.

Announcement 10

This announcement is a reply to an inward, non-TOPS validation. These validations include accepted calling card number, unrestricted

personal identification number (PIN) and known revenue accounting office (RAO).

ACCS announcement 10

Phrase name	Announcement
ACCSENG10	Valid number, unrestricted PIN, R A O: XXX.
ACCSFRE10	Numéro valide, NIP autorisé, B R C: XXX.

Announcement 11

This announcement is a reply to an inward, non-TOPS validation. These validations include accepted calling card number, restricted PIN and known RAO.

ACCS announcement 11

Phrase name	Announcement
ACCSENG11	Valid number, restricted PIN, R A O: XXX.
ACCSFRE11	Numéro valide, NIP non autorisé, B R C: XXX.

Announcement 12

This announcement is a reply to an inward, non-TOPS validation. Validation of the calling card number does not occur because of a database access problem or failure.

ACCS announcement 12

Phrase name	Announcement
ACCSENG12	Valid number, unrestricted PIN, R A O unavailable.
ACCSFRE12	Numéro valide, NIP autorisé, B R C indisponible.

Announcement 13

This announcement is a reply to an inward, non-TOPS validation. The system rejects the calling card number.

ACCS announcement 13

Phrase name	Announcement
ACCSENG13	Invalid number.
ACCSFRE13	Numéro non valide.

Announcement 14

This announcement is a reply to an inward, non-TOPS validation. The system rejects the calling card.

ACCS announcement 14

Phrase name	Announcement
ACCSENG14	Invalid number.
ACCSFRE14	Numéro non valide.

Announcement 15

A termination announcement returns when you cannot access the database because of technical difficulties or outages. The system blocks the call. The subscriber must try the call again.

This announcement is for possible future use only. The system does not block calls because of database problems. The system processes the calls. Validation does not occur.

ACCS announcement 15

Phrase name	Announcement
ACCSENG15	We are sorry, your call did not go through. Please try your call again. This is a recording.
ACCSFRE15	Des difficultés techniques nous empêchent pour l'instant d'acheminer votre appel. Veuillez composer de nouveau. C'était un message enregistré.

Announcement 16

This announcement returns to a subscriber that enters an accepted calling card number or correct called number for a sequence call.

ACCS announcement 16

Phrase name	Announcement
ACCSENG16	Thank you.
ACCSFRE16	Merci.

Announcement (tone) 17

A tone returns to subscriber to indicate that the subscriber can enter the calling card number.

Tones contain 60 ms DTMF # tone, 941/1477 Hz at -10 dbm. A 940 ms of exponentially decayed dial tone follows this tone immediately. The exponentially decayed dial tone is 440/350 Hz with time constant of 200 ms initially at -10 dbm.

Call Forwarding Remote Access

The operating company can have entries so that the DRAM or Audio Node reports the required announcements in one or two languages.

The DRAM PROM memory cards NT1X76AM, English, and NT1X76BM, French, are in use for DRAM announcements. Configure the Audio Node with the following CFRA phrases for IP-based announcements.

The announcements appear in the following table. The first phrase name, with prefix CFRAE, is the English version. The second phrase name, with prefix CFRAF, is the French equivalent. Phrase names LANGUAGE1 and LANGUAGE2 are language delimiters. The phrase names do not have corresponding recorded announcements.

Announcement 1

Please enter the X digit telephone number to forward, followed by your PIN number.

CFRA Announcement 1

Phrase name	Phrase
CFRAEDNPIN1 CFRAFDNPIN1	Please enter
CFRAEDIGITS CFRAFDIGITS	X digit (see Note)
CFRAEDNPIN2 CFRAFDNPIN2	telephone number to forward, followed by your PIN number.

Note: 'X' can be from 1 to 15.

Announcement 2

Please enter a code to activate or deactivate call forwarding.

CFRA Announcement 2

Phrase name	Phrase
CFRAEFAC CFRAFFAC	Please enter a code to activate or deactivate call forwarding.

Announcement 3

Calls to your number will be forwarded to another number. Please enter the number now.

CFRA Announcement 3

Phrase name	Phrase
CFRAEFWDN CFRAFFWDN	Calls to your number will be forwarded to another number. Please enter the number now.

Announcement 4

Calls to your telephone will be forwarded to XXX XXXX. To confirm this, press one; to forward to a different number, press two; to cancel this, please hang up now.

CFRA Announcement 4

Phrase name	Phrase
CFRAEFWD1 CFRAFFWD1	Calls to your telephone will be forwarded to
ENGVARDNF FREVARDNF	XXX XXXX
CFRAEFWD2 CFRAFFWD2	To confirm this, press one; to forward to a different number, press two; to cancel this, please hang up now.

Announcement 5

Your calls cannot be forwarded to XXX XXXX. Please enter another number now.

CFRA Announcement 5

Phrase name	Phrase
CFRAEERR1 CFRAFERR1	Your calls cannot be forwarded to
ENGVARDNF FREVARDNF	XXX XXXX
CFRAEERR2 CFRAFERR2	Please enter another number now.

Announcement 6

Your calls cannot be forwarded to XXX XXXX.

CFRA Announcement 6

Phrase name	Phrase
CFRAEERR1 CFRAFERR1	Your calls cannot be forwarded to
ENGVARDNF FREVARDNF	XXX XXXX

Custom Local Area Signaling Services

These announcements are a requirement for a switching unit with Residential Enhanced Services (RES), CLASS and directory number (DN) attributes software packages.

The operating company can specify that the DRAM or the Audio Node plays the required announcements in one or two languages.

Two announcement examples for the CND feature appear in the following table. The first phrase name is the English version. The second phrase name is the French equivalent.

Please see other NTPs for more information on a particular CLASS feature.

Announcement 1

Information about incoming calls will now be sent to your telephone.

CLASS Announcement 1

Phrase name	Phrase
CNDEINF CNDFINF	Information about incoming calls
CNDEACT CNDFACT	Will now be sent to your telephone.

Announcement 2

Information about incoming calls will no longer be sent to your telephone.

CLASS Announcement 2

Phrase name	Phrase
CNDEINF CNDFINF	Information about incoming calls
CNDEDACT CNDFDACT	Will no longer be sent to your telephone.

Notification of Time and Charge

The NTC feature provides a notification of time and charge announcement. The feature performs this function after answer and release of the call occurs. This call is the call that requests this service. You can enter spoken phrases and silence pauses in table ANNPHLST.

The NTC is available over Integrated Business Network (IBN) integrated services digital network (ISDN) user part (ISUP) trunks to the Japanese domestic market with NCCI Version 1 or 2 protocols.

You can use the NT1X80AA, 4 min. EDRAM, and NT1X80BA, 16 min. EDRAM, cards to store NTC announcements.

The phrases are available to a switch with the NTC feature. The operating company can have entries so that the EDRAM records the required announcements in nine languages.

Phrase names NTCENG and NTCJPN are language delimiters. The phrase names do not have corresponding recorded announcements.

The phrase names and announcement contents for the required and recommended NTC announcement phrases in different languages appear in the following table. These languages include Japanese, English, Mandarin Chinese, Korean, Malay, Portuguese, Spanish, Tagalog and Thai.

Required phrases for Japanese NTC announcements

Phrase name	Announcement
NTCJPN1	zero
NTCJPN2	ichi
NTCJPN3	ni
NTCJPN4	sann
NTCJPN5	yonn
NTCJPN6	yo
NTCJPN7	go
NTCJPN8	roku
NTCJPN9	nana
NTCJPN10	hachi
NTCJPN11	hatt
NTCJPN12	kyuu
NTCJPN13	ku

Required phrases for Japanese NTC announcements

Phrase name	Announcement
NTCJPN14	jyuu
NTCJPN15	jyutt
NTCJPN16	jyuu ichi
NTCJPN17	jyuu ni
NTCJPN18	jyuu san
NTCJPN19	jyuu yonn
NTCJPN20	jyuu yo
NTCJPN21	jyuu go
NTCJPN22	jyuu roku
NTCJPN23	jyuu nana
NTCJPN24	jyuu hachi
NTCJPN25	jyuu kyu
NTCJPN26	jyuu ku
NTCJPN27	ni jyuu
NTCJPN28	san jyuu
NTCJPN29	yon jyuu
NTCJPN30	go jyuu
NTCJPN31	roku jyuu
NTCJPN32	nana jyuu
NTCJPN33	hachi jyuu
NTCJPN34	kyuu jyuu
NTCJPN35	hyaku
NTCJPN36	pyaku

Required phrases for Japanese NTC announcements

Phrase name	Announcement
NTCJPN37	byaku
NTCJPN38	ni hyaku
NTCJPN39	san byaku
NTCJPN40	yon hyaku
NTCJPN41	go hyaku
NTCJPN42	rop pyaku
NTCJPN43	nana hyaku
NTCJPN44	hap pyaku
NTCJPN45	kyuu hyaku
NTCJPN46	senn
NTCJPN47	zenn
NTCJPN48	ni senn
NTCJPN49	sann zenn
NTCJPN50	yon senn
NTCJPN51	go senn
NTCJPN52	roku senn
NTCJPN53	nana senn
NTCJPN54	has senn
NTCJPN55	kyuu senn
NTCJPN56	ichi man
NTCJPN57	ni man
NTCJPN58	sann man
NTCJPN59	yon man

Required phrases for Japanese NTC announcements

Phrase name	Announcement
NTCJPN60	go man
NTCJPN61	roku man
NTCJPN62	nana man
NTCJPN63	hachi man
NTCJPN64	kyuu man
NTCJPN65	man
NTCJPN66	is sen
NTCJPN67	hyaku man
NTCJPN68	byou
NTCJPN69	zero byou
NTCJPN70	ichi byou
NTCJPN71	ni byou
NTCJPN72	sann byou
NTCJPN73	yonn byou
NTCJPN74	go byou
NTCJPN75	roku byou
NTCJPN76	nana byou
NTCJPN77	hachi byou
NTCJPN78	kyuu byou
NTCJPN79	jyuu byou
NTCJPN80	ni jyuu byou
NTCJPN81	san jyuu byou
NTCJPN82	yonn jyuu byou

Required phrases for Japanese NTC announcements

Phrase name	Announcement
NTCJPN83	go jyu byou
NTCJPN84	funn
NTCJPN85	punn
NTCJPN86	zero funn
NTCJPN87	ip punn
NTCJPN88	ni funn
NTCJPN89	sann punn
NTCJPN90	yonn punn
NTCJPN91	go funn
NTCJPN92	rop punn
NTCJPN93	nana funn
NTCJPN94	hap punn
NTCJPN95	kyuu funn
NTCJPN96	jyu punn
NTCJPN97	ni jyu punn
NTCJPN98	san jyu punn
NTCJPN99	yonn jyu punn
NTCJPN100	go jyu punn
NTCJPN101	jikan
NTCJPN102	ichi jikan
NTCJPN103	ni jikan
NTCJPN104	sann jikan
NTCJPN105	yo jikan

Required phrases for Japanese NTC announcements

Phrase name	Announcement
NTCJPN106	go jikan
NTCJPN107	roku jikan
NTCJPN108	nana jikan
NTCJPN109	hachi jikan
NTCJPN110	ku jikan
NTCJPN111	yen
NTCJPN112	ichi yen
NTCJPN113	ni yen
NTCJPN114	sann yen
NTCJPN115	yo yen
NTCJPN116	go yen
NTCJPN117	roku yen
NTCJPN118	nana yen
NTCJPN119	hachi yen
NTCJPN120	kyuu yen
NTCJPN122	de
NTCJPN123	deshita
NTCJPN124	ate

Recommended phrases for Japanese NTC announcements

Phrase name	Announcement
NTCJPN121	Kochirawa idc desu. Tadaimano kokusaidenwano ryokinwa
NTCJPN125	zerozerorokuni goriyou arigatougozaimashita
NTCJPN126	optional

Recommended phrases for Japanese NTC announcements

Phrase name	Announcement
NTCJPN127	optional
NTCJPN128	optional
NTCJPN129	optional
NTCJPN130	optional

Required phrases for English NTC announcements

Phrase name	Announcement
NTCENG3	hours
NTCENG4	hour
NTCENG5	minutes
NTCENG6	minute
NTCENG7	seconds
NTCENG8	second
NTCENG9	long and cost
NTCENG10	yen
NTCENG11	one
NTCENG13	two
NTCENG14	three
NTCENG15	four
NTCENG16	five
NTCENG17	six
NTCENG18	seven
NTCENG19	eight
NTCENG20	nine

Required phrases for English NTC announcements

Phrase name	Announcement
NTCENG21	ten
NTCENG22	eleven
NTCENG23	twelve
NTCENG24	thirteen
NTCENG25	fourteen
NTCENG26	fifteen
NTCENG27	sixteen
NTCENG28	seventeen
NTCENG29	eighteen
NTCENG30	nineteen
NTCENG31	twenty
NTCENG32	thirty
NTCENG33	forty
NTCENG34	fifty
NTCENG35	sixty
NTCENG36	seventy
NTCENG37	eighty
NTCENG38	ninety
NTCENG39	hundred
NTCENG40	thousand
NTCENG41	million
NTCENG43	zero

Recommended phrases for English NTC announcements

Phrase name	Announcement
NTCENG1	This is IDC. The international call you have just made
NTCENG2	was
NTCENG12	Thank you for using IDC. This is a recording.
NTCENG42	repeat
NTCENG44	This is IDC. The international call you have just made was
NTCENG45	the number
NTCENG46	to
NTCENG47	optional
NTCENG48	optional
NTCENG49	optional
NTCENG50	optional
NTCENG51	optional

Recommended phrases for English CLASS announcements

Phrase name	Announcement
CLASSENG65	no telephone number is stored.

Required phrases for Mandarin Chinese NTC announcements

Phrase name	Announcement
NTCCHMAN2	xiaoshi
NTCCHMAN3	fen
NTCCHMAN4	miao
NTCCHMAN6	yuan
NTCCHMAN10	yi

Required phrases for Mandarin Chinese NTC announcements

Phrase name	Announcement
NTCCHMAN11	er
NTCCHMAN12	san
NTCCHMAN13	si
NTCCHMAN14	wu
NTCCHMAN15	liu
NTCCHMAN16	qi
NTCCHMAN17	ba
NTCCHMAN18	jiu
NTCCHMAN19	liang
NTCCHMAN20	shi
NTCCHMAN21	shiyi
NTCCHMAN22	she ir
NTCCHMAN23	shisan
NTCCHMAN24	shis
NTCCHMAN25	shisi
NTCCHMAN26	shiwu
NTCCHMAN27	shiliu
NTCCHMAN28	shiqi
NTCCHMAN29	shiba
NTCCHMAN30	shijiu
NTCCHMAN31	bai
NTCCHMAN32	quian
NTCCHMAN33	wan

Required phrases for Mandarin Chinese NTC announcements

Phrase name	Announcement
NTCCHMAN34	er-shi
NTCCHMAN35	san-shi
NTCCHMAN36	si-shi
NTCCHMAN37	wu-shi
NTCCHMAN38	liu-shi
NTCCHMAN39	qi-shi
NTCCHMAN40	ba-shi
NTCCHMAN41	jiu-shi

Recommended phrases for Mandarin Chinese NTC announcements

Phrase name	Announcement
NTCCHMAN1	Zhe Li Shi IDC. Ning Da De Guo Ji Dian Hua Yong La
NTCCHMAN5	Jin E Shi
NTCCHMAN6	yuan
NTCCHMAN7	Chong Fu Yi Bian
NTCCHMAN8	dui fang hao ma shi
NTCCHMAN9	Gan xie nin shi yong IDC guo ji dian hua. Gang cai nin.

Required phrases for Korean NTC announcements

Phrase name	Announcement
NTCKOREAN3	bun
NTCKOREAN4	cho
NTCKOREAN10	pun

Required phrases for Korean NTC announcements

Phrase name	Announcement
NTCKOREAN11	kong
NTCKOREAN12	il
NTCKOREAN13	i
NTCKOREAN14	sam
NTCKOREAN15	sa
NTCKOREAN16	o
NTCKOREAN17	yuk
NTCKOREAN18	ch'il
NTCKOREAN19	p'all
NTCKOREAN20	ku
NTCKOREAN21	yong
NTCKOREAN22	ship
NTCKOREAN23	ship-il
NTCKOREAN24	ship-i
NTCKOREAN25	ship-sam
NTCKOREAN26	ship-sa
NTCKOREAN27	ship-o
NTCKOREAN28	ship-yuk
NTCKOREAN29	ship-ch'il
NTCKOREAN30	ship-p'ai
NTCKOREAN31	ship-ku
NTCKOREAN32	paek
NTCKOREAN33	ch'on

Required phrases for Korean NTC announcements

Phrase name	Announcement
NTCKOREAN34	man
NTCKOREAN35	i-ship
NTCKOREAN36	sam-ship
NTCKOREAN37	sa-ship
NTCKOREAN38	o-ship
NTCKOREAN39	yuk-ship
NTCKOREAN40	ch'il-ship
NTCKOREAN41	p'ai-ship
NTCKOREAN42	ku-ship
NTCKOREAN43	han
NTCKOREAN44	tu
NTCKOREAN45	se
NTCKOREAN46	ne
NTCKOREAN47	tasot
NTCKOREAN48	yosot
NTCKOREAN49	ilgop
NTCKOREAN50	yodoi
NTCKOREAN51	ahop
NTCKOREAN52	yui
NTCKOREAN53	yui-han
NTCKOREAN54	yui-tu
NTCKOREAN55	yui-se
NTCKOREAN56	yui-ne

Required phrases for Korean NTC announcements

Phrase name	Announcement
NTCKOREAN57	yui-tasot
NTCKOREAN58	yui-yosot
NTCKOREAN59	yui-ilgop
NTCKOREAN60	yui-yodoi
NTCKOREAN61	yui-ahop
NTCKOREAN62	sum
NTCKOREAN63	sumui
NTCKOREAN64	sorun
NTCKOREAN65	mapun
NTCKOREAN66	shun
NTCKOREAN67	yesun
NTCKOREAN68	ilpun
NTCKOREAN69	yudun
NTCKOREAN70	apun

Recommended phrases for Korean NTC announcements

Phrase name	Announcement
NTCKOREAN1	YogninunIDC imnida Yoropunkeso iyonhagci keshimun kucche chonanun
NTCKOREAN5	en imnida
NTCKOREAN6	Tashi maisum dourkessumnida
NTCKOREAN7	en imyo
NTCKOREAN8	purkwa tonhwahayossumnida

Recommended phrases for Korean NTC announcements

Phrase name	Announcement
NTCKOREAN9	IDC nui iyonhayo chusyuso dedani kamsahamnida lgosun nogum teipuinida
NTCKOREAN71	to yogumun

Required phrases for Malay NTC announcements

Phrase name	Announcement
NTCMALAY3	jam
NTCMALAY4	minit
NTCMALAY5	saat
NTCMALAY7	yen
NTCMALAY12	Kosong
NTCMALAY13	Satu
NTCMALAY14	Dua
NTCMALAY15	Tiga
NTCMALAY16	Empat
NTCMALAY17	Lima
NTCMALAY18	Enam
NTCMALAY19	Tujuh
NTCMALAY20	Lapan
NTCMALAY21	Sembilan
NTCMALAY22	Sepuluh
NTCMALAY23	Sebalas
NTCMALAY24	DuaBelas
NTCMALAY25	TigaBelas
NTCMALAY26	EmpatBelas

Required phrases for Malay NTC announcements

Phrase name	Announcement
NTCMALAY27	LimaBelas
NTCMALAY28	EnamBelas
NTCMALAY29	TujuhBelas
NTCMALAY30	LapanBelas
NTCMALAY31	SembilanBelas
NTCMALAY32	DuaPuluh
NTCMALAY33	Seratus
NTCMALAY34	Ratus
NTCMALAY35	Seribu
NTCMALAY36	Ribu
NTCMALAY37	Sejuta
NTCMALAY38	TigaPuluh
NTCMALAY39	EmpatPuluh
NTCMALAY40	LimaPuluh
NTCMALAY41	EnamPuluh
NTCMALAY42	TujuhPuluh
NTCMALAY43	LapanPuluh
NTCMALAY44	SembilanPuluh
NTCMALAY45	Jutah

Recommended phrases for Malay NTC announcements

Phrase name	Announcement
NTCMALAY1	Ini ialah IDC Pangilan antarabangsa yang baru saja anda buat,
NTCMALAY2	selama

Recommended phrases for Malay NTC announcements

Phrase name	Announcement
NTCMALAY6	bayarannya ialah
NTCMALAY8	duilangi
NTCMALAY9	panngilan ke
NTCMALAY10	nombor
NTCMALAY11	Terima kasih kerana menggunakan IDC.

Required phrases for Portuguese NTC announcements

Phrase name	Announcement
NTCPORTG2	horas
NTCPORTG3	minutos
NTCPORTG4	e
NTCPORTG5	segundos
NTCPORTG6	hora
NTCPORTG7	minuto
NTCPORTG8	segundo
NTCPORTG10	iene
NTCPORTG11	ienes
NTCPORTG15	zero
NTCPORTG16	um
NTCPORTG17	dois
NTCPORTG18	tres
NTCPORTG19	quatro
NTCPORTG20	cinco
NTCPORTG21	seis

Required phrases for Portuguese NTC announcements

Phrase name	Announcement
NTCPORTG22	sete
NTCPORTG23	oto
NTCPORTG24	nove
NTCPORTG25	des
NTCPORTG26	onze
NTCPORTG27	doze
NTCPORTG28	treze
NTCPORTG29	quatorze
NTCPORTG30	quinze
NTCPORTG31	dessesseis
NTCPORTG32	dessessete
NTCPORTG33	dezoto
NTCPORTG34	deznove
NTCPORTG35	vinte
NTCPORTG36	vinte e
NTCPORTG37	trinta
NTCPORTG38	trinta e
NTCPORTG39	quarenta
NTCPORTG40	quarenta e
NTCPORTG41	cinquenta
NTCPORTG42	cinquenta e
NTCPORTG43	sessenta
NTCPORTG44	sessenta e

Required phrases for Portuguese NTC announcements

Phrase name	Announcement
NTCPORTG45	setenta
NTCPORTG46	setenta e
NTCPORTG47	otenta
NTCPORTG48	otenta e
NTCPORTG49	noventa
NTCPORTG50	noventa e
NTCPORTG51	cem
NTCPORTG52	cemto
NTCPORTG53	cemto e
NTCPORTG54	duzentos
NTCPORTG55	duzentos e
NTCPORTG56	trezentos
NTCPORTG57	trezentos e
NTCPORTG58	quatrocentos
NTCPORTG59	quatrocentos e
NTCPORTG60	quinhentos
NTCPORTG61	quinhentos e
NTCPORTG62	seiscentos
NTCPORTG63	seiscentos e
NTCPORTG64	setecentos
NTCPORTG65	setecentos e
NTCPORTG66	otocentos
NTCPORTG67	otoscentos e

Required phrases for Portuguese NTC announcements

Phrase name	Announcement
NTCPORTG68	novecentos
NTCPORTG69	novecentos e
NTCPORTG70	mil
NTCPORTG71	mil e
NTCPORTG72	mihao de
NTCPORTG73	mihao e
NTCPORTG74	mihao
NTCPORTG75	mihoes de
NTCPORTG76	mihoes e
NTCPORTG77	mihoes
NTCPORTG78	de
NTCPORTG79	uma
NTCPORTG80	duas
NTCPORTG81	duzentas

Recommended phrases for Portuguese NTC announcements

Phrase name	Announcement
NTCPORTG1	Aqui e a IDC. A chamada internacional qua acaba de ser feat tave a duracao de
NTCPORTG9	a custou
NTCPORTG12	Repatimos
NTCPORTG13	a camada toi para.
NTCPORTG14	Agradecemos por utilizar a IDC.

Required phrases for Spanish NTC announcements

Phrase name	Announcement
NTCSPAIN2	horas
NTCSPAIN3	minutos
NTCSPAIN4	segundos
NTCSPAIN5	hora
NTCSPAIN6	minuto
NTCSPAIN7	segundo
NTCSPAIN9	yenes
NTCSPAIN10	yen
NTCSPAIN15	cero
NTCSPAIN16	uno
NTCSPAIN17	dos
NTCSPAIN18	tres
NTCSPAIN19	cuatro
NTCSPAIN20	cinco
NTCSPAIN21	seis
NTCSPAIN22	siete
NTCSPAIN23	ocho
NTCSPAIN24	nueve
NTCSPAIN25	un
NTCSPAIN26	diez
NTCSPAIN27	once
NTCSPAIN28	doce
NTCSPAIN29	trece

Required phrases for Spanish NTC announcements

Phrase name	Announcement
NTCSPAIN30	catorce
NTCSPAIN31	quince
NTCSPAIN32	dieciseis
NTCSPAIN33	diecisiete
NTCSPAIN34	dieciocho
NTCSPAIN35	diecinueve
NTCSPAIN36	viente
NTCSPAIN37	vientun
NTCSPAIN38	trienta
NTCSPAIN39	y
NTCSPAIN40	trienta y
NTCSPAIN41	cuarenta
NTCSPAIN42	cuarenta y
NTCSPAIN43	cinquenta
NTCSPAIN44	cinquenta y
NTCSPAIN45	sesenta
NTCSPAIN46	sesenta y
NTCSPAIN47	setenta
NTCSPAIN48	setenta y
NTCSPAIN49	ochenta
NTCSPAIN50	ochenta y
NTCSPAIN51	noventa
NTCSPAIN52	noventa y

Required phrases for Spanish NTC announcements

Phrase name	Announcement
NTCSPAIN53	cien
NTCSPAIN54	ciento
NTCSPAIN55	doscientos
NTCSPAIN56	trescientos
NTCSPAIN57	cuatrocientos
NTCSPAIN58	quinientos
NTCSPAIN59	seiscientos
NTCSPAIN60	setecientos
NTCSPAIN61	ochocientos
NTCSPAIN62	novecientos
NTCSPAIN63	mil
NTCSPAIN64	million de
NTCSPAIN65	vientidos
NTCSPAIN66	vientitres
NTCSPAIN67	vienticuatro
NTCSPAIN68	vienticinco
NTCSPAIN69	vientiseis
NTCSPAIN70	vientisiete
NTCSPAIN71	vientiocho
NTCSPAIN72	vientinueve
NTCSPAIN73	million
NTCSPAIN74	milliones de
NTCSPAIN75	milliones

Required phrases for Spanish NTC announcements

Phrase name	Announcement
NTCSPAIN76	una
NTCSPAIN77	vientiuna

Recommended phrases for Spanish NTC announcements

Phrase name	Announcement
NTCSPAIN1	Habia IDC. La tamada internacional que acaba de realizar duro
NTCSPAIN8	de duracion
NTCSPAIN11	Repetimos
NTCSPAIN12	y ei importe es de
NTCSPAIN13	al numero.
NTCSPAIN14	Gracias por usar IDC. Esta Es una grabacion.

Required phrases for Tagalog NTC announcements

Phrase name	Announcement
NTCTGALO2	oras
NTCTGALO3	minuto
NTCTGALO4	segundo
NTCTGALO6	yen
NTCTGALO13	sero
NTCTGALO14	one
NTCTGALO15	two
NTCTGALO16	three
NTCTGALO17	four
NTCTGALO18	five

Required phrases for Tagalog NTC announcements

Phrase name	Announcement
NTCTGALO19	six
NTCTGALO20	seven
NTCTGALO21	eight
NTCTGALO22	nine
NTCTGALO23	isang
NTCTGALO24	dalawang
NTCTGALO25	tatlong
NTCTGALO26	apatna
NTCTGALO27	limang
NTCTGALO28	animna
NTCTGALO29	pitong
NTCTGALO30	walong
NTCTGALO31	slyamna
NTCTGALO32	sampung
NTCTGALO33	labing-isang
NTCTGALO34	labin-dalawang
NTCTGALO35	labin-tatlong
NTCTGALO36	labing-apatna
NTCTGALO37	labin-limang
NTCTGALO38	labing-animna
NTCTGALO39	labim-pitong
NTCTGALO40	labing-walong
NTCTGALO41	labin-siyamna

Required phrases for Tagalog NTC announcements

Phrase name	Announcement
NTCTGALO42	dalawampung
NTCTGALO43	dalawampu't
NTCTGALO44	tatlumpung
NTCTGALO45	tatlumpu't
NTCTGALO46	apatnapung
NTCTGALO47	apatnapu't
NTCTGALO48	limampung
NTCTGALO49	limampu't
NTCTGALO50	animnapung
NTCTGALO51	animnapu't
NTCTGALO52	pitumpung
NTCTGALO53	pitumpu't
NTCTGALO54	walumpung
NTCTGALO55	walumpu't
NTCTGALO56	siyamnapung
NTCTGALO57	siyamnapu't
NTCTGALO58	daang
NTCTGALO59	daa't
NTCTGALO60	raang
NTCTGALO61	raa't
NTCTGALO62	libong
NTCTGALO63	libo't

Required phrases for Tagalog NTC announcements

Phrase name	Announcement
NTCTGALO64	milyong
NTCTGALO65	milyon at

Recommended phrases for Tagalog NTC announcements

Phrase name	Announcement
NTCTGALO1	Ito pong IDC. Ang inyong international call kanina ay
NTCTGALO6	at umobot ng
NTCTGALO7	Uullin ko po
NTCTGALO8	ang inyo pong tawag
NTCTGALO9	sa
NTCTGALO10	numerong
NTCTGALO11	Maraming saiamat po sa inyong paggamit ng IDC
NTCTGALO12	Ito po ay recording

Required phrases for Thai NTC announcements

Phrase name	Announcement
NTCTHAI2	chuamong
NTCTHAI3	naathii
NTCTHAI4	winaathii
NTCTHAI6	yen
NTCTHAI12	Soon
NTCTHAI13	Nurrg
NTCTHAI14	Too
NTCTHAI15	Saam

Required phrases for Thai NTC announcements

Phrase name	Announcement
NTCTHAI16	Sii
NTCTHAI17	Haa
NTCTHAI18	Hok
NTCTHAI19	Jed
NTCTHAI20	Paad
NTCTHAI21	Gao
NTCTHAI22	Song
NTCTHAI23	Sip
NTCTHAI24	SipEd
NTCTHAI25	SipSong
NTCTHAI26	SipSaam
NTCTHAI27	SipSii
NTCTHAI28	SipHaa
NTCTHAI29	SipHok
NTCTHAI30	SipJed
NTCTHAI31	SipPaad
NTCTHAI32	SipGao
NTCTHAI33	YiiSip
NTCTHAI34	Ed
NTCTHAI35	Rooi
NTCTHAI36	Phan
NTCTHAI37	Murn
NTCTHAI38	Saan

Required phrases for Thai NTC announcements

Phrase name	Announcement
NTCTHAI39	Laan
NTCTHAI40	SaamSip
NTCTHAI41	SiiSip
NTCTHAI42	HaaSip
NTCTHAI43	HokSip
NTCTHAI44	JedSip
NTCTHAI45	PaadSip
NTCTHAI46	GaoSip

Recommended phrases for Thai NTC announcements

Phrase name	Announcement
NTCTHAI1	Thii nii IDC than dai chai boorikan thoorasap rawaang prathet pen weelaa
NTCTHAI5	pen ngen
NTCTHAI7	Yam than daai chai boorikan thoorasap rawaang prathet
NTCTHAI8	pai yang
NTCTHAI9	maalieek thoorasap
NTCTHAI10	pen weelaa
NTCTHAI11	khoo khoobphrakhun thii chai boorikan khoong IDC le niikhuu tapebanthuksiang

Silence phrases for NTC

Phrase name	Time duration
NTCSLNC250MS	250 ms

Silence phrases for NTC

Phrase name	Time duration
NTCSLNC500MS	500 ms
NTCSLNC1SEC	1 s

The NTCSLNC500MS is the only compound phrase. A phrase assignment is not a requirement.

Station Programmable PIN (SPP)

This feature allows subscribers to change the PIN from the telephone through a feature access code. The SPP assignment can occur for each customer group. Possible SPP announcements that the operating company can custom record, appear in the following examples. Northern Telecom (Nortel) recommends announcement 1 for phrase SPPANNC1. Refer to section 7 of the *DRAM and EDRAM Guide* for additional information about how to create customized recordings on a DRAM. Configure the Audio Node with the following SPP phrases for IP-based announcements.

The phrase names and announcements for this feature appear in the following table.

SPP announcements

Phrase name	Phrase
SPPANNC1	Please enter the feature access code for the PIN you wish to change.
SPPANNC2	Please enter your PIN number.
SPPANNC3	Please enter a NEW PIN number.
SPPANNC4	Please re-enter the NEW PIN number.
SPPANNC5	The NEW PIN number has been updated.
SPPANNC6	You have entered an incorrect PIN number.
SPPANNC7	You have exceeded the number of retries. Please hang up and try again.

SPP announcements

Phrase name	Phrase
SPPANNC8	Call Forwarding Remote Access
CFRAFRST	Access to this feature is prohibited until you change your PIN number. The PIN number change must be made from your own phone.

Subscriber Activated Call Blocking (SACB)

This feature allows a subscriber to control originations from the line of the subscriber. To control originations, the subscribers can identify Call Classes that restrict completion to specified dialed numbers. Enter Call Classes in Table SACB. Specify the Call Classes to restrict when you add the SACB option to the line of a subscriber during a SERVORD session.

Use an access code to activate and deactivate the SACB option. To override active SACB blocking, provide a PIN in response to the SACB blocking announcement.

Examples of possible SACB announcements, that the operating company can custom record, appear in the following table. Refer to section 7 of the *DRAM and EDRAM Guide* for additional information about how to create customized recordings on a DRAM. Configure the Audio Node with the following SACB phrases for IP-based announcements.

The phrase names and recommended announcements for this feature appear in the following table.

SACB announcements

Phrase name	Phrase
SACBANNC1	Please enter your PIN number.
SACBANNC2	The subscriber call blocking feature is activated. To override this restriction, please enter your PIN number.
SACBANNC3	The subscriber call blocking feature has been activated.
SACBANNC4	The subscriber call blocking feature has been deactivated.

SACB announcements

Phrase name	Phrase
SACBANNC5	You have entered an incorrect PIN number.
SACBANNC6	Please re-enter your PIN number.
SACBANNC7	You have exceeded the number of retries. Please hang up and try again.
SPPANNC9	Subscriber Activated Call Blocking

CS-1R announcements

The Capability Set 1 Revised (CS-1R) announcements are Intelligent Network (IN) custom announcements. Table ANNPHLST defines the phrases that are part of CS-1R announcements. Each CS-1R announcement can contain fixed phrases, or fixed and variable phrases.

Fixed phrases

Fixed phrases are prerecorded announcement phrases. Refer to *Digital Recorded Announcement Machine DRAM and EDRAM Guide* for information on prerecorded announcements.

Variable phrases

Variable phrase identifiers announce variable digits and variable integers in English or Mandarin. The following variable phrase identifiers are place containers in CS-1R announcements:

- ENGLISHVARDIG
- ENGLISHVARINT
- MANDARINVARDIG
- MANDARINVARINT

The service control point (SCP) supplies digits or integer data. This data maps to the phrase identifiers. Each announcement in table ANNPHLST can contain zero to five variable phrases.

These digits or integer data map to one of these phrase identifiers. Each announcement in table ANNPHLST can contain a maximum of five variable phrases. Each variable digit, ENGLISHVARDIG or MANDARINVARDIG, supports a maximum of 32 digits. Each integer digit, ENGLISHVARINT or MANDARINVARINT, supports an integer value of zero to 2 147 483 647.

The DRAMREC utility fills variable digit phrases with a group of variable phrases during call processing. The DRAMREC uses the digits the SCP supplies as input. The DRAMREC provides a list of phrases as output. Refer to *Digital Recorded Announcement Machine DRAM and EDRAM Guide* for information of DRAMREC.

Mandarin phrases that require to be pre-recorded to support variable announcements

Phrase name	Announcement
LANG_CAN	Play the variable announcement in Cantonese
IN_ZERO_CHNMAN	Mandarin '0'
IN_ONE_CHNMAN	Mandarin '1'
IN_TWO_CHNMAN	Mandarin '2'
IN_THREE_CHNMAN	Mandarin '3'
IN_FOUR_CHNMAN	Mandarin '4'
IN_FIVE_CHNMAN	Mandarin '5'
IN_SIX_CHNMAN	Mandarin '6'
IN_SEVEN_CHNMAN	Mandarin '7'
IN_EIGHT_CHNMAN	Mandarin '8'
IN_NINE_CHNMAN	Mandarin '9'
IN_SHI_CHNMAN	Mandarin '10'
IN_BAI_CHNMAN	Mandarin 'bai (hundred)
IN_QIAN_CHNMAN	Mandarin 'qian' (thousand)
IN_WAN_CHNMAN	Mandarin 'wan' (ten thousand)

Mandarin phrases that require to be pre-recorded to support variable announcements

Phrase name	Announcement
IN_YUAN_CHNMA N	Mandarin 'yuan' (RMB unit)
IN_JIAO_CHNMAN	Mandarin 'jiao' (RMB subunits)
IN_FEN_CHNMAN	Mandarin 'fen' (RMB subunits)
IN_NIAN_CHNMAN	Mandarin 'nian' (year)
IN_YUE_CHNMAN	Mandarin 'yue' (month)
IN_RI_CHNMAN	Mandarin 'ri' (day)
IN_HOUR_CHNMA N	Mandarin 'shi' (hour)
IN_MINUTE_CHNM AN	Mandarin 'fen' (minute)
IN_SECOND_CHN MAN	Mandarin 'miao' (second)

Cantonese phrases that require to be pre-recorded to support variable announcements

Phrase name	Announcement
IN_ZERO_CHNCA N	Cantonese '0'
IN_ONE_CHNCAN	Cantonese '1'
IN_TWO_CHNCAN	Cantonese '2'
IN_THREE_CHNC AN	Cantonese '3'
IN_FOUR_CHNCA N	Cantonese '4'
IN_FIVE_CHNCAN	Cantonese '5'
IN_SIX_CHNCAN	Cantonese '6'

Cantonese phrases that require to be pre-recorded to support variable announcements

Phrase name	Announcement
IN_SEVEN_CHNCAN	Cantonese '7'
IN_EIGHT_CHNCAN	Cantonese '8'
IN_NINE_CHNCAN	Cantonese '9'
IN_SHI_CHNCAN	Cantonese '10'
IN_BAI_CHNCAN	Cantonese 'bai (hundred)
IN_QIAN_CHNCAN	Cantonese 'qian' (thousand)
IN_WAN_CHNCAN	Cantonese 'wan' (ten thousand)
IN_YUAN_CHNCAN	Cantonese 'yuan' (RMB unit)
IN_JIAO_CHNCAN	Cantonese 'jiao' (RMB subunits)
IN_FEN_CHNCAN	Cantonese 'fen' (RMB subunits)
IN_NIAN_CHNCAN	Cantonese 'nian' (year)
IN_YUE_CHNCAN	Cantonese 'yue' (month)
IN_RI_CHNCAN	Cantonese 'ri' (day)
IN_HOUR_CHNCAN	Cantonese 'shi' (hour)
IN_MINUTE_CHNCAN	Cantonese 'fen' (minute)
IN_SECOND_CHNCAN	Cantonese 'miao' (second)

INDIGIT Phrases

Before GL04, INDIGIT phrases were in use. These phrases must now change to common phrases. The common phrases appear in the following table.

Change INDIGIT Phrases to Common Phrases

Change from	Change to	
<i>INDIGIT Phrase</i>	<i>ENGLISH Phrases</i>	<i>MANDARIN Phrases</i>
INDIGIT	ENGLISHVARDIG	MANDARINVARDIG
INDIG0	CMNENG	CMNMDN
INDIG1	CMNENG	CMNMDN
INDIG2	CMNENG	CMNMDN
INDIG3	CMNENG	CMNMDN
INDIG4	CMNENG	CMNMDN
INDIG5	CMNENG	CMNMDN
INDIG6	CMNENG	CMNMDN
INDIG7	CMNENG	CMNMDN
INDIG8	CMNENG	CMNMDN
INDIG9	CMNENG	CMNMDN

Provisioning requirements

Table ANNS defines the characteristics of each CS-1R announcement. The ANTYPE field in table ANNS must be IN for the CS-1R announcement software to function. The CS-1R announcements are visible if CS-1R software is active in the load.

Separate DRAMs are a requirement if more than one language is in use to record variable announcements. Refer to *Digital Recorded Announcement Machine DRAM and EDRAM Guide* for additional information.

The system must record the following announcement phrase identifiers.

Required phrases for English CS-1R announcements

Phrase name	Announcement
CMNENG0	zero
CMNENG1	one
CMNENG2	two
CMNENG3	three
CMNENG4	four
CMNENG5	five
CMNENG6	six
CMNENG7	seven
CMNENG8	eight
CMNENG9	nine
CMNENG10	ten
CMNENG11	eleven
CMNENG12	twelve
CMNENG13	thirteen
CMNENG14	fourteen
CMNENG15	fifteen
CMNENG16	sixteen
CMNENG17	seventeen
CMNENG18	eighteen
CMNENG19	nineteen
CMNENG20	twenty
CMNENG21	thirty

Required phrases for English CS-1R announcements

Phrase name	Announcement
CMNENG22	forty
CMNENG23	fifty
CMNENG24	sixty
CMNENG25	seventy
CMNENG26	eighty
CMNENG27	ninety
CMNENG28	hundred
CMNENG29	thousand
CMNENG30	million
CMNENG31	billion

Recommended phrases for Mandarin CS-1R announcements

Phrase name	Announcement
CMNMDN0	ling
CMNMDN1	yi
CMNMDN2	er
CMNMDN3	san
CMNMDN4	si
CMNMDN5	wu
CMNMDN6	liu
CMNMDN7	qi
CMNMDN8	ba
CMNMDN9	jiu
CMNMDN10	shi

Recommended phrases for Mandarin CS-1R announcements

Phrase name	Announcement
CMNMDN11	shiyi
CMNMDN12	shi'er
CMNMDN13	shisan
CMNMDN14	shishi
CMNMDN15	shiwu
CMNMDN16	shiliu
CMNMDN17	shiqi
CMNMDN18	shiba
CMNMDN19	shijiu
CMNMDN20	er-shi
CMNMDN21	san-shi
CMNMDN22	si-shi
CMNMDN23	wu-shi
CMNMDN24	liu-shi
CMNMDN25	qi-shi
CMNMDN26	ba-shi
CMNMDN27	jiu-shi
CMNMDN28	bai
CMNMDN29	quain
CMNMDN30	wan
CMNMDN31	yi
CMNMDN32	liang

CS-1R Pre-Paid Services (introduction)

This feature is currently restricted to Succession networks, which use the CS2K platform and the Universal Audio Server (UAS) peripheral.

An Intelligent Network Application Part (INAP) operation may include numerical data to be formatted into an announcement on the receiving switch. This feature provides a means for INAP to play a variable announcement of service charge, in specified language(s) and currency, on a per-service basis.

Refer to the end of the ANNPHLST table description for a detailed discussion of this feature.

Datavill examples

The figure that follows shows basic sample datavill for table ANNPHLST with phrases for both broadcast (BLDNANN) and custom (CFRAANN) type.

MAP display example for table ANNPHLST

```
ANNPHKEY PHSLIST
-----
BLDNANN 3 (BLDNPHR1) $
BLDNANN 4 (BLDNPHR2) $
CFRAANN 1 (LANGUAGE1) (CFRAEDNPIN1) (CFRAEDIGITS) (CFRAEDNPIN2) $
CFRAANN 2 (LANGUAGE1) (CFRAEFAC) $
BOTTOM
```

An example of the standard announcements for MCCS appears in the following figure. The MCCSTOPS18 to 23 are available in switching units with the TOPS alternate announcement software package.

```
ANNPHKEY
          PHSLIST
```

```
MCCSTOPS 1
MCCSENG 1 $
MCCSTOPS 2
  MCCSENG2 $
MCCSTOPS 3
  MCCSENG3 $
MCCSTOPS 4
  MCCSENG4
MCCSTOPS 5
  MCCSENG5 $
MCCSTOPS 6
  MCCSENG6 $
MCCSTOPS 7
  MCCSENG7 $
MCCSTOPS 8
  MCCSENG8 $
MCCSTOPS 9
  MCCSENG9 $
MCCSTOPS 10
  MCCSENG10 $
MCCSTOPS 11
  MCCSENG11 $
MCCSTOPS 12
  MCCSENG12 $
MCCSTOPS 13
  MCCSENG13 $
MCCSTOPS 14
  MCCSENG14 $
MCCSTOPS 15
  MCCSENG15 $
MCCSTOPS 16
  MCCSENG16 $
MCCSTOPS 17
  MCCSENG17 $
MCCSTOPS 18
  MCCSENG18 $
MCCSTOPS 19
  MCCSENG19 $
MCCSTOPS 20
  MCCSENG20 $
MCCSTOPS 21
  MCCSENG21 $
MCCSTOPS 22
  MCCSENG22 $
MCCSTOPS 23
  MCCSENG23 $
```

An example of the standard announcements for ACTS appears in the following figure. The ACTSTOPS14 to 19 are available in switching units with the TOPS alternate announcement software package.

ANNPHKEY	PHSLIST
ACTSTOPS 1	(ACTS_VAR_CHARGE) (ACTS_PLEASE) (ACTS_PAUSE) (ACTS_PLS_DEPOSIT) (ACTS_VAR_CHARGE) (ACTS_FOR_FIRST) (ACTS_VAR_PERIOD) \$
ACTSTOPS 1	(ACTS_VAR_CHARGE) (ACTS_PLEASE) (ACTS_PAUSE) (ACTS_PLS_DEPOSIT)
ACTSTOPS 2	(ACTS_PLS_DEPOSIT) (ACTS_VAR_CHARGE) \$
ACTSTOPS 3	(ACTS_PLS_DEPOSIT) (ACTS_VAR_CHARGE) (ACTS_MORE) \$
ACTSTOPS 4	(ACTS_THANK_YOU) \$
ACTSTOPS 5	(ACTS_THANK_HAVE) (ACTS_VAR_CREDIT) (ACTS_CR_OVERTIME) \$
ACTSTOPS 6	(ACTS_ALERT) (ACTS_VAR_PERIOD) (ACTS_END_SIGNAL) \$
ACTSTOPS 7	(ACTS_ALERT) (ACTS_VAR_CHARGE) (ACTS_PLEASE) (ACTS_PAUSE) (ACTS_PLS_DEPOSIT) (ACTS_VAR_CHARGE) (ACTS_FOR_PAST) (ACTS_VAR_PERIOD) \$
ACTSTOPS 8	(ACTS_ALERT) (ACTS_VAR_CHARGE) (ACTS_PLEASE) (ACTS_PAUSE) (ACTS_YOU_HAVE) (ACTS_VAR_CREDIT) (ACTS_CREDIT) (ACTS_PLS_DEPOSIT) (ACTS_VAR_CHARGE) (ACTS_MORE) (ACTS_FOR_PAST) (ACTS_VAR_PERIOD) \$
ACTSTOPS 9	(ACTS_ALERT) (ACTS_CHARGES_ARE) (ACTS_VAR_CHARGE) (ACTS_PLUS_TAX) (ACTS_VAR_PERIOD) \$
ACTSTOPS 10	(ACTS_ALERT) (ACTS_VAR_PERIOD) (ACTS_HAS_ENDED) \$
ACTSTOPS 11	(ACTS_TST_DEPOSIT) (ACTS_VAR_COIN) \$
ACTSTOPS 12	(ACTS_PAUSE) (ACTS_ALERT) \$
ACTSTOPS 13	(ACTS_THANK_YOU) (ACTS_VAR_COIN) (ACTS_TST_ENDED) \$
ACTSTOPS 14	(ACTS_PLS_DEPOSIT) (ACTS_VAR_CHARGE) \$
ACTSTOPS 15	(ACTS_PLS_DEPOSIT) (ACTS_VAR_CHARGE) \$
ACTSTOPS 16	(ACTS_PLS_DEPOSIT) (ACTS_VAR_CHARGE) (ACTS_MORE) \$
ACTSTOPS 17	(ACTS_THANK_YOU) \$
ACTSTOPS 18	(ACTS_THANK_HAVE) (ACTS_VAR_CREDIT) (ACTS_CR_OVERTIME) \$
ACTSTOPS 19	(ACTS_ALERT) (ACTS_CHARGES_ARE) (ACTS_VAR_CHARGES) (ACTS_PLUS_TAXES) (ACTS_VAR_PERIOD) \$
ACTSTOPS 20	(ACTS_ALERT) (ACTS_VAR_CHARGE) (ACTS_PLEASE) (ACTS_PAUSE) (ACTS_PLS_DEPOSIT) (ACTS_VAR_CHARGE) (ACTS_FOR_NEXT) (ACTS_VAR_PERIOD) \$
ACTSTOPS 21	(ACTS_ALERT) (ACTS_VAR_CHARGE) (ACTS_PLEASE) (ACTS_PAUSE) (ACTS_PLS_DEPOSIT) (ACTS_VAR_CHARGE) (ACTS_MORE) (ACTS_FOR_NEXT) (ACTS_VAR_PERIOD) \$
ACTSTOPS 22	(ACTS_PLS_DEPOSIT) (ACTS_VAR_CHARGE) \$
ACTSTOPS 23	(ACTS_PLS_DEPOSIT) (ACTS_VAR_CHARGE)

An example of the standard bilingual announcements for ACCS appears in the following figure. The English version of the announcements appears first.

```
ANNPHKEY  
  
PHSLIST  
  
-----  
  
ACCSTOPS 1  
  ACCSEMG1 ACCSFRE1 $  
ACCSTOPS 2  
  ACCSEMG2 ACCSFRE2 $  
ACCSTOPS 3  
  ACCSEMG3 ACCSFRE3 $  
ACCSTOPS 4  
  ACCSEMG4 ACCSFRE4 $  
ACCSTOPS 5  
  ACCSEMG5 ACCSFRE5 $  
ACCSTOPS 6  
  ACCSEMG6 ACCSFRE6 $  
ACCSTOPS 7  
  ACCSEMG7 ACCSFRE7 $  
ACCSTOPS 8  
  ACCSEMG8 ACCSFRE8 $  
ACCSTOPS 9  
  ACCSEMG9 ACCSFRE9 $  
ACCSTOPS 10  
  ACCSEMG10 ACCSFRE10 $  
ACCSTOPS 11  
  ACCSEMG11 ACCSFRE11 $  
ACCSTOPS 12  
  ACCSEMG12 ACCSFRE12 $  
ACCSTOPS 13  
  ACCSEMG13 ACCSFRE13 $  
ACCSTOPS 14  
  ACCSEMG14 ACCSFRE14 $  
ACCSTOPS 15  
  ACCSEMG15 ACCSFRE15 $  
ACCSTOPS 16  
  ACCSEMG16 ACCSFRE16 $  
ACCSTOPS 17  
  ACCSEMG17 ACCSFRE17 $
```

An example of customized bilingual announcements for ACCS appears in the following figure. The French version of the announcements appears first.

```

ANNPHKEY
PHSLIST
-----
ACCSTOPS 17
  ACCSTONE $
ACCSTOPS 18
  ACCSTONE $
ACCSTOPS 19
  ACCSTONE $
ACCSTOPS 20
  ACCSFRE9 ACCSENG9 $
ACCSTOPS 21
  ACCSFRE9 ACCSENG9 $
ACCSTOPS 22
  ACCSFRE16 ACCSENG16 $
ACCSTOPS 23
  ACCSFRE5 ACCSENG5 $
ACCSTOPS 24
  ACCSTONE $
ACCSTOPS 25
  ACCSTONE $

```

An example of customized bilingual announcements for the CFRA feature appears in the following figure. The English version of the announcements appears first.

```

ANNPHKEY
PHSLIST
-----
CFRAANN 1
  LANGUAGE1 CFRAEDNPIN1 CFRAEDIGITS CFRAEDNPIN2 LANGUAGE2
CFRAFDNPIN1 CFRAFDIGITS CFRAFDNPIN2 $
CFRAANN 2
  LANGUAGE1 CFRAEFAC LANGUAGE2 CFRAFFAC $
CFRAANN 3
  LANGUAGE1 CFRAEFWDN LANGUAGE2 CFRAFFWDN $
CFRAANN 4
  LANGUAGE1 CFRAEFDW1 ENGVARDNF CFRAEFDW2 LANGUAGE2 CFRAFFDW1
FREWARDNF CFRAFFWD2 $
CFRAANN 5
  LANGUAGE1 CFRAEERR1 ENGVARDNF CFRAEERR2 LANGUAGE2 CRRAFERR1
FREWARDNF CFRAFERR2 $
CFRAANN 6
  LANGUAGE1 CFRAEERR1 ENGVARDNF LANGUAGE2 CFRAFERR1 FREWARDNF $

```

An example of customized bilingual announcements for the CLASS feature appears in the following figure. The English version of the announcements appears first.

ANNPKKEY	PHSLIST
CLASSANN 1 LANGUAGE1 CNDEINF CNDEACT LANGUAGE2 CNDFINF CNDFACT \$	
CLASSANN 2 LANGUAGE1 CNDEINF CNDEACT LANGUAGE2 CNDFINF CNDFACT \$	

An example of CS-1R announcements appears in the following figure.

ANNPKKEY	PHSLIST
CS1ANN 1 (ENGLISHVARDIG) \$	
CS1ANN 2 (PHRASE1) (MANDARINVARINT) \$	
CS1ANN 3 (ENGLISHVARDIG) (ENGLISHVARINT) \$	
CS1ANN 4 (CMNMDN7) (MANDARINVARDIG) (PHRASE2) \$	
CS1ANN 5 (PHRASE3) (MANDARINVARDIG) (PHRASE2) (MANDARINVARDIG) (CMNMDN3) \$	

CS-1R Pre-Paid Services

This feature is currently restricted to Succession networks, which use the CS2K platform and the Universal Audio Server (UAS) peripheral.

An Intelligent Network Application Part (INAP) operation may include numerical data to be formatted into an announcement on the receiving switch. This feature provides a means for INAP to play a variable announcement of service charge, in specified language(s) and currency, on a per-service basis.

Functionality and datafill: languages

This feature changes the way in which language is specified for Intelligent Network (IN) variable announcements. The feature introduces ISO 639-2 codes as language discriminators, and also introduces INAP support for Chinese, Japanese, German, Turkish and Italian languages.

In MMP, there is a separate IN variable component for each supported language. For example, the variable ENG_IN_VAR specifies an announcement in English. The mapping to a specific announcement is achieved through datafill in table AINANNS.

The new functionality separates the language specification from the declaration of the IN variable. Thus 'ENG_IN_VAR', for example, is replaced by the language discriminator 'ENG' and the INAP variable part placeholder 'IN_VAR'.

Datafill example

Typical datafill in tables AINANNS and ANNPHLST for an announcement in English is shown below.

```
TABLE AINANNS
7005 IN_VAR_ANNC 5
TABLE ANNPHLST
IN_VAR_ANNC 5 (ENG) (IN_VAR)$
```

Supported UAS languages

The table below identifies the languages and the corresponding ISO 639-2 language code that the UAS can support.

The 'INAP Support - CS2K' column indicates whether the language is supported for INAP variable announcements in the SN05 release. Languages that are not currently supported can be datafilled, but will have no effect.

For reference the 'INAP Support - MMP' column identifies whether the language is available on the MMP platform (through the use of the original 'ENG_IN_VAR' style datafill).

Supported UAS ISO 639-2 Announcement Languages

Language	ISO 639-2 Terminology Code	Implemented in UAS Rel. #	INAP Support	
			MMP	CS2K
Czech	CES	UAS 06	No	No
German	DEU	UAS 03	No	Yes
Greek	ELL	UAS 06	No	No
English	ENG	UAS 2.1	Yes	Yes
French	FRA	UAS 03	Yes	Yes
Hebrew	HEB	UAS 06	No	No

Supported UAS ISO 639-2 Announcement Languages

Language	ISO 639-2 Terminology Code	Implemented in UAS Rel. #	INAP Support	
			MMP	CS2K
Italian	ITA	UAS 03	No	Yes
Japanese	JPN	UAS 05	No	Yes
Korean	KOR	UAS 05	No	No
Malay	MAY	UAS 05	No	No
Netherlands Dutch	NLD	UAS 03	No	No
Portuguese	POR	UAS 04	Yes	Yes
Spanish	SPA	UAS 2.1	Yes	Yes
Tagalog	TGL	UAS 05	No	No
Thai	THA	UAS 05	No	No
Turkish	TUR	UAS 06	No	Yes
Vietnamese	VIE	UAS 06	No	No
Chinese	ZHO	UAS 05	No	Yes

Functionality and datafill: currencies

This feature introduces ISO 4217 currency identifiers to table ANNPHLST. Currencies are datafilled as a three letter ASCII identifier. For example, the ISO 4217 identifier for GB Pounds is 'GBP'.

The identifier specifies the currency to be used for all subsequent variable phrase(s), until either the end of the announcement, or until another currency identifier is specified.

Datafill example: single-language, single-currency announcement

Typical datafill in tables AINANNS and ANNPHLST for an announcement in English, and a currency of GB Pounds, is shown below. The announcement resulting from this datafill is "Twelve pounds and fifty pence".

```

TABLE AINANNS
7006 IN_VAR_ANNC 6
TABLE ANNPHLST
IN_VAR_ANNC 6 (ENG) (GBP) (IN_VAR) $

```

Datafill example: two-language, two-currency announcement

Typical datafill in tables AINANNS and ANNPHLST is shown below for:

- an announcement in English, with currency GB Pounds, followed by
- the equivalent announcement in French, with currency Euros

The combined announcement resulting from this datafill is “Twelve pounds and fifty pence, vingt euros et cinquante quatre cents”.

```

TABLE AINANNS
7007 IN_VAR_ANNC 7
TABLE ANNPHLST
IN_VAR_ANNC 6 (ENG) (GBP) (IN_VAR) (FRE) (EUR) (IN_VAR) $

```

Supported currency codes

The table below lists the ISO 4217 currency codes that are added to ANNPHLST to support the feature.

Supported Currency Codes

Country	Currency	ISO Code
Austria	Schilling	ATS
Australia	Australian Dollar	AUD
Brazil	Brazilian Real	BRL
Chile	Chilean Peso	CLP
China	Yuan Renminbi	CNY
Germany	Deutsche Mark	DEM

Supported Currency Codes

Country	Currency	ISO Code
Spain	Spanish Peseta	ESP
European Monetary Union	EU Euro	EUR
France	French Franc	FRF
United Kingdom	UK Sterling	GBP
Guyana	Guyana Dollar	GYD
Hong Kong	Hong Kong Dollar	HKD
Haiti	Haitian Gourde	HTG
Hungary	Hungarian Forint	HUF
Ireland	Irish Pound	IEP
Japan	Japanese Yen	JPY
Morocco	Moroccan Dirham	MAD
Mexico	Mexican Peso	MXN
Mexico MTX	Mexican Peso	MXN
Peru	Nuevo Sol	PEN
Poland	Polish Zloty	PLN
CIS	Russian Ruble	RUR
Turkey	Turkish Lira	TRL
North America	US Dollar	USD
Caribbean Exp. Proj.	East Caribbean Dollar	XCD

Additional information

Information on how to assign the SIT in table ANNPHLST with commands SITLOAD and ASSIGN appears in this section. The information is for switches with PROM and RAM cards.

Machine detectable encodings (SIT)

The system treats calls that route to an announcement as completed calls. The system provides voice responses for these calls are provided as a result of analysis of machine detectable encodings by call disposition equipment. A machine detectable encoding provides a

quicker call disposition if the encoding is at the beginning of each recorded announcement. These machine detectable encodings are special information tones (SIT). The maximum number of SITs is 32. Each SIT has three different frequencies and durations. The SIT indicate that a machine-generated announcement follows.

This feature is optional.

SITs in PROM or RAM speech cards

A DRAM can store SITs in PROM or RAM speech cards.

The PROM speech cards can store all data for SITS.

Some switches can only use RAM speech cards. These switches do not require standard Bell Canada format announcements of PROM cards. The SIT data can be stored in central control (CC) data store. The data can be downloaded to the RAM speech cards when a switch equipped only with RAM cards goes in service. The additional download is a requirement if RAM cards memory is lost. The download time is approximately 3 min.

The CC instructs the DRAM to play the SIT and the announcement for a call that terminates on an announcement.

The DRAMREC commands ASSIGN and RECORD supply the CC with information on each announcement phrase in the DRAM. The ASSIGN command provides information to the CC on phrases the PROM cards store. The RECORD command has parameters that provide information on phrases to record on RAM cards. These commands do not identify the phrases with specified SITs.

The SITs can download from data store to RAM cards. This download can only occur in switches that do not have PROM cards.

Each RAM card contains a 128-kbyte block that includes four kilobytes of menu and SIT data. The 124 kilobytes that remain store speech data. The download requires two RAM cards for the SIT tones. The menu data that relates to the SITs can be split. One half of the SITS is in one RAM card. The other half of the SITS is in another RAM card. The SIT data is compressed to save recording space. The same SIT data must be stored in both cards. If only one RAM card stores the SIT data, store for 8 s of speech tones on that card are removed to accommodate all the SIT phrase identifiers.

Module DRAMSIT downloads SIT data from the CC store to the RAM speech store of the DRAM. The command interpreter (CI) command SITLOAD initiates the download of SITs. The SIT tone data is a data

string in the CC data store. This data is downloaded on the first two available RAM cards in table DRAMS. The first 16 SITs are on the first RAM card. The next 16 SITs are on the second RAM card.

When the download completes, a message that indicates the completed download appears to the user.

Use the ASSIGN command to assign phrases to PROM cards. Use the ASSIGN command to assign SIT phrase identifiers to PROM and RAM cards.

The DRAM announcement phrases in each track of a multitrack announcement are the same length. The duration of a SIT is 1 s. The SIT is only on the primary language track. The secondary language track is 1 s shorter than the primary language track. The two tracks next to each other go out of synchronization because of this difference. To overcome this problem, a 1 s SILENCE phrase is assigned on a PROM card or a RAM card. The phrase plays at the beginning of each of the tracks that are next to each other.

SITLOAD command

The SITLOAD command downloads SIT data from data store to the first two RAM cards. In the example below, the SITs are loaded to DRAM number 0.

```
>SITLOAD 0
```

If you enter a PROM card in table DRAMS, do not use command SITLOAD. The PROM cards store SITs. Use only the ASSIGN command to notify the system that with regard to SITs in switches with PROM cards.

Before you use the SITLOAD command, make sure that a minimum of two RAM cards are in the maintenance trunk module (MTM) shelf. The MTM shelf relates to the DRAM used. Make sure that the required datafill for these RAM cards is in table DRAMS.

The phrase names that relate to each SIT require assignment when the SITLOAD command activates.

ASSIGN command

If the ASSIGN command is in use to assign SIT phrases and the SILENCE phrase, the following rules apply.

Switching units with PROM cards

To assign a SIT phrase name in a switching unit with PROM cards, use the command

```
>ASSIGN <dram_ no> <SIT phrase name> <length> <block>
<phrase _no>
```

In the following example, assign the SILENCE phrase

- for 1 s
- to DRAM number 0, entered in table DRAMS
- to the block number assigned to the first PROM card, entered in table DRAMS

```
>ASSIGN 0 SILENCE 1 1 0
```

Assign each separate SIT phrase. The phrase numbers, the SIT parts, and the SIT phrase names appear in the following table. The SIT phrase assignments are limited to the first PROM card only.

An example of an assignment of separate SIT phrases appears in the following table.

Example assigning individual SIT phrases

Phrase number	SIT components	SIT phrase names
8	ISISIS	SIT1
9	ISISIL	SIT2
10	ILISIS	SIT3
11	IShLIL	SIT4
12	IShSIS	SIT5
13	IShSIL	SIT6
14	IShLIS	SIT7
15	IShLIL	SIT8
16	ILISIS	SIT9

Note: I = low frequency, h = high frequency, S = short duration, L = long duration

Example assigning individual SIT phrases

Phrase number	SIT components	SIT phrase names
17	ILISIL	SIT10
18	ILILIS	SIT11
19	ILhLIL	SIT12
20	ILhSIS	SIT13
21	ILhSIL	SIT14
22	ILhLIS	SIT15
23	ILhLIL	SIT16
24	hShSIS	SIT17
25	hShSIL	SIT18
26	hShLIS	SIT19
27	hShLIL	SIT20
28	hShSIS	SIT21
29	hShSIL	SIT22
30	hShLIS	SIT23
31	hShLIS	SIT24
32	hLISIS	SIT25
33	hLISIL	SIT26
34	hLILIS	SIT27
35	hLILIL	SIT28
36	hLhSIS	SIT29
37	hLhSIL	SIT30

Note: I = low frequency, h = high frequency, S = short duration, L = long duration

Example assigning individual SIT phrases

Phrase number	SIT components	SIT phrase names
38	hLhLIS	SIT31
39	hLhLIL	SIT32
Note: I = low frequency, h = high frequency, S = short duration, L = long duration		

The firmware can give the SIT phrase a phrase number of 8. The software can give the SIT phrase the phrase name SIT1. The preceding table indicates that these actions can occur to a SIT phrase with the following components:

- first component tone of low (l) frequency, short duration (S)
- second component tone of low (l) frequency, short duration (S)
- third component tone of low (l) frequency, short duration (S)

When you assign all SIT phrases, the datafill in table ANNPHLST changes to include the SIT and the SILENCE tones.

See the above example for SIT and SILENCE phrase assignment.

Switching units with RAM cards

Enter data in a minimum of two RAM cards and no PROM cards in table DRAMS. The SITLOAD command must be a success. Assign the SILENCE phrase to the first RAM card. Assign the first 16 SIT phrases to the first RAM card. Assign the last 16 SIT phrases to the second RAM card. The ASSIGN command has the same format as the format that appears for the PROM card in this document.

An example of how to assign SIT phrases to RAM cards appears in the following figure.

Example of datafill for table DRAMS

DRAMCARD	TMTYPE	TMNO	TMCKT	CARDCODE	CARDINFO
0 0	MTM	3 0	1X75AA		
				CTLR	DRAM0
0 1	MTM	3 2	1X75AA		
				RAM3	
0 2	MTM	3 4	1X75AA		
				RAM4	

In the figure above, the command SITLOAD loads the data for the first 16 SIT phrases into RAM card 1, block number 3. The command SITLOAD loads the second set of 16 SIT phrases in RAM card 2, block number 4.

The first phrase in the first set 16 SIT is assigned as follows:

```
>ASSIGN 0 SIT1 1 3 48
```

The first phrase from the second set of 16 SIT is assigned as follows:

```
>ASSIGN 0 SIT17 1 4 48
```

The SILENCE phrase is assigned only one time as follows:

```
>ASSIGN 0 SILENCE 1 3 0
```

When you assign all SIT phrases, enter data in these phrases in table ANNPHLST. The SIT phrases includes the SILENCE phrase.

See the "Datafill example" section for an example of datafill in table ANNPHLST.

An example of phrase numbers assigned on the first RAM card appears in the following table.

Phrase numbers on first RAM card

Phrase number	SIT components	SIT phrase names
48	ISIS	SIT1
49	ISISIL	SIT2
50	ISILIS	SIT3
51	ISILIL	SIT4
52	IShSIS	SIT5
53	IShSIL	SIT6
54	IShLIS	SIT7
55	hLILIS	SIT8
56	ILISIS	SIT9
57	ILISIL	SIT10
58	ILILIS	SIT11
59	ILILIL	SIT12
60	ILhSIS	SIT13
61	ILISIL	SIT14
62	ILhLIS	SIT15
63	ILhLIL	SIT16

Note: I = low frequency, h = high frequency, seconds = short duration, L = long duration

An example of phrase numbers assigned on the second RAM card appears in the following table.

Phrase numbers on second RAM card

Phrase number	SIT components	SIT phrase names
48	hSISIS	SIT17
49	hSISIL	SIT18
50	hSILIS	SIT19
51	hSILIL	SIT20
52	hShSIS	SIT21
53	hShSIS	SIT22
54	hShSIS	SIT23
55	hShLIL	SIT24
56	hLISIS	SIT25
57	hLISIL	SIT26
58	hLILIS	SIT27
59	hLILIL	SIT28
60	hLhSIS	SIT29
61	hLhSIL	SIT30
62	hLhLIS	SIT31
63	hLhLIS	SIT32

Note: I = low frequency, h = high frequency, S = short duration, L = long duration

Announcements

In table ANNPHLST, the SIT that comes before each standard announcements follows the guidelines that appear in the following

table. The operating company decides which SIT phrases come before the customized recorded announcements.

Standard announcements

SIT	Category	Announcements
SIT2	Customer irregularity	Automatic Intercept System (AIS), blank directory number Integrated Business Network (IBN) numbers, change and non-working stations Access code not dialed Access code dialed in error
SIT8	Equipment irregularity	Reorder
SIT2 6	Vacant code	Vacant code Unauthorized centralized automatic message accounting (CAMA)
SIT3 2	Trunk blockage	No circuit emergency

The SIT phrase names that correspond to the standard Bell Canada announcements appear in the following table.

Standard Bell Canada announcements

SIT	Category	Announcements
SIT2	BLKDN	Blank directory number
	PSPD	Permanent signal/partial dial
	NOD1	Do not dial prefix 1
	D1ER	Prefix digit 1 not dialed
	ROH	Receiver off-hook
SIT26	VCA	Vacant code
SIT32	NCA	No circuit

Table history

SN09 (DMS)

The explanations and example datafill for custom announcement types MCCS and ACTS were updated in SN09 for feature A00009013, to correct errors and to document that these applications can use either DRAM or packet announcement resources. Also, the description of AOSSVR was deleted.

The information about custom announcement type AOSSVR was removed in SN09 by feature A00009013. This application was specific to TOPS MP positions, which are no longer supported.

Description of table ANNPHLST added to UCS documentation.

SN06 (DMS) and ISN06 (TDM)

Table introduced by feature A19013546. The introduction of table ANNPHLST makes tables DRMUSERS and DRAMTRK obsolete. These tables can still be accessed, but no data can be entered into them.

Mandarin and Cantonese phrases that require to be pre-recorded added by feature 89008388.

ANNS

Table name

Announcement Table

Functional description

This table contains data for each analog and digital announcement that is assigned in the switching unit.

For all line connections to announcements, the central control (CC) instructs the connecting peripheral modules (PM) to use a 0-dB (zero) pad level on the line card gain setting. This is a default value and cannot be administered. A 0-dB pad level is the nil pad group (NPDGP). For further information, refer to table PADATA.

Datafill sequence and implications

The following tables must be datafilled before table ANNS:

- CLLI
- DRAMS

The following tables must be datafilled after table ANNS:

- ANNMEMS
- DRAMTRK
- DRMUSERS

Before a Subscriber Activated Call Blocking (SACB) announcement can be entered in table ANNS, an announcement CLLI must first be entered in table CLLI. An entry for SACB announcements can then be entered in table ANNS. Once value SACB is entered in table ANNS, the data for each announcement member must be entered in table ANNMEMS, and the phrases recorded on the DRAM cards must be entered in table DRMUSERS.

DMS-100 SSP standard announcements are datafilled in table ANNS and are mapped to the system announcement ID in table AINANS. DMS-100SSP customized announcements are datafilled in tables ANNS and DRMUSERS and are mapped to the system announcement ID in table AINANS.

Table size

0 to 255 tuples

ANNS (continued)

Memory for table ANNS is allocated dynamically.

Note: The size of table ANNS increases if tables CUSTANN and NSCANNS and if XN26AA or X983AB are present in the office. With these tables, the size of table ANNS increases to 2047 tuples. This increase is needed to support a larger number of customer groups (300 to 500).

Datafill

The following table lists datafill for table ANNS.

Field descriptions

Field	Subfield or refinement	Entry	Explanation and action
CLLI		alphanumeric (1 to 16 characters)	<p><i>Announcement CLLI keys</i> Enter the code that represents the announcement in table CLLI.</p> <p>If the Attendant Busy feature is present in the switching unit, the suggested common language location identifier (CLLI) for Attendant Busy is ATTBUSY.</p> <p>If the Music On Hold feature is present in the switch, the suggested CLLI for the Music On Hold announcement is MUSIC.</p> <p>Each loudspeaker location must have its own Announcement CLLI associated with it.</p> <p>Enter fixed CLLI TOPSACTS if field ANTYPE is set to ACTS for automatic coin toll service. Office parameter TOPS_ACTS must be set to Y (yes) in table OFCENG.</p>

ANNS (continued)

Field descriptions

Field	Subfield or refinement	Entry	Explanation and action
ANNTYP		ACTS, AIN, AIS, AOSSVR, CFPA, CFRA, CLASS, CNAL, CNALT, CNAT, CSMI, DMCT, ECWTPA, IN, MCCS, MDS, NFRA, NTC, RCTL, SACB, SLEENG, SLEFRE, SPP, STND, TOPSVR or VPSA (DMS-250 only)	<p><i>Announcement type</i> Enter the announcement type as follows:</p> <ul style="list-style-type: none"> • ACTS to specify Automatic Coin Toll Service • AIN to specify a given DMS user interface for each customer group • AIS to specify Automatic Intercept System announcement if the switch has the AIS feature • AOSSVR to specify AOSS Voice Response • CFPA to specify Call Forwarding Programming announcement • CFRA to specify Call Forwarding Remote Access announcement • CLASS to specify Custom Local Area Signaling Services announcement • CNAL to specify Calling Number Announcement playback to a line • CNAT to specify Calling Number Announcement playback over a trunk to a loudspeaker • CSMI to specify Call Screening, Monitoring, and Intercept • DMCT to specify Denied Malicious Call Termination

ANNS (continued)**Field descriptions**

Field	Subfield or refinement	Entry	Explanation and action
			<ul style="list-style-type: none"> • ECWTPA to specify Enhanced Call Waiting Programming announcements • IN to specify an Intelligent Network (IN) Capability Set 1 Revised (CS-1R) custom announcement. • MCCS to specify Mechanized Calling Card Announcement • MDS to specify Audiogram Delivery Services (ADS) announcements. Refer to the Audiogram Delivery Services-offer of Service Prompt functionality (ENSV0013) in this document. • NFRA to specify Network facility Remote Access • NTC to specify Notification of Time and Charge announcement • RCTL to specify Subscriber Programmable Ringing for CFDVT (SPRING) • SLEENG to specify Screening List Editing English • SLEFRE to specify Screening List Editing French • SPP to specify Station Programmable PIN (Personal Identification Number) • STND to specify Standard Announcement • SACB to specify Subscriber Activated Call Blocking • TOPSVR to specify TOPS Voice Response <p>Office parameter TOPS_ACTS must be set to Y in table OFCENG</p> <ul style="list-style-type: none"> • VPSA to indicate Variable Phrase Standard Announcement (VPSA) phrases such as DNAENG (dialed number digits), CHAENG (charged number digits), CGAENG (calling number digits) or CNAENG (called number digits). For DMS-250 only.

ANNS (continued)

Field descriptions

Field	Subfield or refinement	Entry	Explanation and action
	GAP	Y, N	<p><i>GAP</i> Enter the value Y to generate a gap between the tracks of a multi-track announcements. Enter N to have no gap between the track of a multi-track announcements. The system produces the GAP prompt only for selected announcement types.</p>
TRAFSNO		0 to127	<p><i>Traffic separation numbers</i> If the switch has feature package X085AA (Traffic Separation Peg Count), enter the Traffic Separation number, 1 to 127, that is assigned to the announcement. If the traffic separation is not required, enter 0 (zero).</p> <p>For switches with package X085AA, the range of values for the traffic separation number depends on office parameter TFAN_OUT_MAX_NUMBER in table OFCENG.</p> <p>For switching units without package X085AA, the range of values for the traffic separation numbers is 0 to 15.</p> <p>Reserve the traffic separation numbers 1 to 9 for generic traffic separation numbers.</p> <p>Refer to table TFANINT for more information.</p>
MAXCONN		1 to 255	<p><i>Maximum connections</i> Enter the maximum number of simultaneous connections that are permitted on the announcement. An entry outside this range is invalid.</p> <p>IF ANNTYPE is equal to VPSA or CNAT, a value of 255 must be entered.</p> <p>For XA-Core, Nortel Networks recommends 255 be entered.</p>

ANNS (continued)**Field descriptions**

Field	Subfield or refinement	Entry	Explanation and action
CYTIME		1 to 18 or 0	<p data-bbox="813 464 1403 680"><i>Cycle times</i> Enter the time, in seconds, for one announcement cycle on one channel (see the second, third, and fourth tables in this document). An entry outside this range is invalid and will cause the recorded announcement to be cut-off, at which point the line will be placed in a SYSBSY state.</p> <p data-bbox="813 720 1403 936">Note 1: If the announcement cycle is longer than 18 seconds, field CYTIME can be changed to 0 (zero). This allows flexible announcement timing, which does not have a maximum limit for announcement length. The length of the announcement is always matched without datafill change.</p> <p data-bbox="813 957 1403 1077">Note 2: If your office is equipped with a Cook or equivalent announcement machine and table AUDIO is datafilled as ANNS, 0 is datafilled in field CYTIME.</p> <p data-bbox="813 1098 1403 1251">Note 3: The cycle time for an Audichron is 0 (zero) due to the variable length announcement feature on Audichron. By setting the value of this field to 0 (zero), the length of the announcement is always matched.</p>

ANNS (continued)

Field descriptions

Field	Subfield or refinement	Entry	Explanation and action
MAXCYC		1 to 255	<p><i>Maximum cycles</i></p> <p>Enter the maximum number of times the complete announcement is heard before the call is advanced to the next route in the route list. An entry outside of this range is invalid.</p> <p>This field must be set to 1 for multilingual NTC service. For multilingual NTC service, since one tuple represents one language and one announcement cycle contains several languages, each tuple in table DRMUSERS is used only once before advancing to the next tuple (language) in the same cycle. Thus, the number of announcement cycles datafilled in table ANNS must be one to ensure that languages are repeated in the proper sequence.</p> <p>This field should be set to "1" for ADS announcements. Refer to the Audiogram Delivery Services-Offer of Service Prompt functionality (ENSV0013) in this document.</p>

The following table shows the times for one cycle of prerecorded announcement. Use this table to datafill field CYTIME.

If special information tone (SIT) or silence is the first phrase for the announcement in the DRAMTRK table, add 1 s to the values shown.

The time shown has been rounded off to the next second. The value in brackets is the actual value.

One-cycle prerecorded announcement time

Announcement	Time (in seconds)
No circuit (NCA)	10 (9.248)
Sender overload (SOA)	10 (9.248)
Reorder (ROA)	9 (8.96)
Vacant code (VCA)	12 (12.032)
Unauthorized code (UCA)	12 (12.032)

ANNS (continued)**One-cycle prerecorded announcement time**

Announcement	Time (in seconds)
Receiver off-hook (ROH)	13 (12.544)
Vacant disconnect	7 (6.208)
Misdirected centralized	11 (10.592)
Automatic message accounting (AMA) toll access code not dialed	10 (10.016)

The following table shows cycle times for digits.

One-cycle digit time

Digit	Duration
0	1 (.608)
1	1 (.512)
2	1 (.544)
3	1 (.544)
4	1 (.640)
5	1 (.768)
6	1 (.640)
7	1 (.672)
8	1 (.544)
9	1 (.672)

The following table shows cycle times for special symbols.

One-cycle special symbol time

Special symbol	Duration
Silence	1 (1.024)
Test tone	1 (.160)
Prompt	1 (.992)

ANNS (continued)**Datafill example**

The following example shows sample datafill for table ANNS.

MAP display example for table ANNS

CLLI	ANNTYP	TRAFSNO	MAXCONN	CYTIME	MAXCYC	
CNALINE	CNAL	Y	0	1	4	1
PSPD	STND	Y	26	30	10	2
TDND	STND	Y	25	30	10	2
CKTBSY	STND	Y	25	30	10	2
MLA	STND	Y	25	30	10	2
MCA	STND	Y	25	30	10	2
OHQANNC	STND	Y	25	30	10	2
VDN	STND	Y	25	30	10	2
VCA	STND	Y	25	30	10	2
EA4	STND	Y	25	30	10	2
EA3	STND	Y	25	30	10	2
WND	STND	Y	0	90	15	2
VACT	STND	Y	0	90	15	2
BLDN	STND	Y	0	90	15	2
CLASSANN	CLASS		30	1	0	1
CFRAANN	CFRA		25	1	0	2
ARCONF	STND	Y	0	90	16	2
ACBBUSY	STND	Y	0	90	16	2
ARBUSY	STND	Y	0	90	16	2
ACBSTD	STND	Y	0	90	16	2
ARSTD	STND	Y	0	90	16	2
ACBLTD	STND	Y	0	90	16	2
ARLTD	STND	Y	0	90	16	2
ACBDEACT	STND	Y	0	90	16	2
ARDEACT	STND	Y	0	90	16	2
ARDN	STND	Y	0	90	16	2
ARPRIV	STND	Y	0	90	16	2
ACBCONF	STND	Y	0	90	16	2
CONFCOT	STND	Y	0	90	16	2
FAILCOT	STND	Y	0	90	16	2
PRMT1COT	STND	Y	0	90	16	2
PRMTNCOT	STND	Y	0	90	16	2
SLEENG1	SLEENG		25	1	0	1
SLEENG2	SLEENG		25	1	0	1
ADBFANN	STND	Y	30	30	0	3
PVNCOLA	STND	Y	0	1	4	2
PVNCOLB	STND	Y	0	1	3	2
PVNCOLC	STND	Y	0	1	9	2
PVNCOLD	STND	Y	0	1	2	2

ANNS (continued)

Table history**NA017**

DMS-100 SSP standard and customized announcements are datafilled in table ANNS as a result of feature 59037140.

MMP13

Added ANNTYPE Variable Phrase Standard Announcement (VPSA) for DMS-250 only. Changed MAXCONN entry to 255 for ANNTYPE = VPSA or CNAT for XA-Core.

NA010

Feature AJ5131 adds subfield GAP to selected announcement types in field ANTYPE. This supports gapping of multi-track announcements.

APC010

Added announcement types CFPA, ECWTPA, and RCTL for the Enhanced Call Waiting feature.

GL03

Added announcement type IN to field ANTYPE for an Intelligent Network (IN) Capability Set 1 Revised (CS-1R) custom announcement.

APC06

Added information associated with multilingual NTC service.

NA005

Added announcement type RCTL to field ANTYPE for the SPRING feature.

Changed entry for field CYTIME for flexible announcement time.

Feature AN1542 in the functionality Audiogram Delivery Services-Offer of Service Prompt functionality (ENSV0013) introduces the ANTYPE "MDS" for ADS announcements and specific datafill requirements for the MAXCYC field.

Added announcement type CSMI to field ANNTYPE for Call Screening, Monitoring and Intercept.

APC04

Value NTC was added to field ANTYPE.

ANNS (end)

BCS36

A clarification of line connections to announcements was added. Value DMCT was added to field ANTYPE.

APCDINV

Table name

Application Processor Card Inventory Table

Functional description

Table APCDINV contains the descriptions of the following:

- the resource processor (RP) cards
- the cards of the application processors (APs)
- all cards that a file processor (FP) contains except the cards that mass storage devices contain
- the power converters on the AP/FP shelf

Related table APINV contains the configuration data the RP MAP facility and the Integrated Node Maintenance (INM) software requires. The tuples you enter in table APINV causes the system to add default tuples to table APCDINV. The tuples you add in table APINV for an AP causes the system to add the following tuples to table APCDINV:

- One tuple for each of the two slots that contain power converters.
- One tuple for each of two specified slots. These two slots contain a central processing unit (CPU) card in the front and a reset terminal interface (RTIF) paddleboard in the back.
- One tuple for each of two specified slots. These slots contain a port card in the front and a port card in the back.
- One tuple for each of the two slots that contain the required memory cards
- One tuple for each of the two slots that contain bus terminators

When you add a new AP tuple to table APINV, the system automatically adds ten tuples in total to table APCDINV. When you delete the main tuple for the AP from table APINV, the system deletes all tuples for an AP.

The tuples you enter in table APINV for an FP causes the system to add the following tuples to table APCDINV:

- One tuple for each of the two slots that contain power converters.
- One tuple for each of two specified slots. These slots contain a CPU card in the front and an RTIF paddleboard in the back.
- One tuple for each of the two slots. These two slots contain a port card in the front and a port card in the back.
- One tuple for each of the two slots that contain the required memory cards.

APCDINV (continued)

- One tuple for each of the two slots that contain bus terminators.
- One tuple for each of two specified slots. These slots contain a dual-access buffer memory card in the front. These slots contain a small computer interface (SCSI) paddleboard in the back.

When you add a new FP tuple to table APINV, the system automatically adds 12 tuples in total to table APCDINV. When you delete the main tuple for the FP from table APIN, the system deletes all tuples for an FP.

Datafill sequence and meaning

Enter data in the following tables before you enter data in table APCDINV:

- MSCDINV
- PMLOADS
- APINV

Table size

Memory for table APCDINV has a dynamic definition. The maximum size of table APCDINV is 2800 tuples. The number of nodes in table APINV determines the required data store. This condition occurs because the system automatically adds most of the data in table APCDINV. The system adds the data when you enter data in table APINV. Each AP requires 250 words of data store. Each FP requires 250 words of data store with an additional 150 words. The additional 150 words are for the addition of cards not on the same shelf or quadrant as the FP is.

Datafill

The data entries for table APCDINV appear in the following table.

Field descriptions (Sheet 1 of 3)

Field	Subfield or refinement	Entry	Explanation and action
SMNTYPE		AP or FP	<i>Sync-matched node type.</i> Enter AP to indicate an application processor. Enter FP to indicate a file processor. This key is the first of a four-part key.
SMNNO		0 to 99	<i>Sync-matched node instance number.</i> Enter the instance number of the resource processor. This key is the second of a four-part key.

APCDINV (continued)**Field descriptions (Sheet 2 of 3)**

Field	Subfield or refinement	Entry	Explanation and action
SHELF		0 to 3	<i>Shelf number.</i> Enter the shelf number that contains the RP. The shelves begin with the number zero (0) at the bottom and are numbered from bottom to top. This key is the third of a four-part key.
SLOT		1 to 38	<i>System slot.</i> Enter the Northern Telecom (Nortel) slot number. This key is the fourth of a four-part key.
FRONTCRD		CPU MEMORY PORT POWER or NIL	<i>Front card element class.</i> Enter the element group of the card in the front side of the card slot.
FRONTPEC		NTDX15AA, NT9X13LA, NT9X14DA, NT9X14DB, NT9X86AA, NT9X87AA, NT9X91AA or NIL	<p><i>Front card product engineering code.</i> Enter the product engineering code (PEC) for the card entered in field FRONTCRD.</p> <p>If the entry in field FRONTCRD is CPU, enter NT9X13LA.</p> <p>If the entry in field FRONTCRD is MEMORY, enter NT9X14DA, NT9X14DB or NT9X87AA.</p> <p>If the entry in field FRONTCRD is PORT, enter NT9X86AA.</p> <p>If the entry in field FRONTCRD is POWER, enter NT9X91AA or NTDX15AA. Any entry that is not NT9X91AA or NTDX15AA is not correct.</p> <p>If the entry in field FRONTCRD is NIL, enter NIL. The card slot is empty or has a filler card.</p>

APCDINV (end)

Field descriptions (Sheet 3 of 3)

Field	Subfield or refinement	Entry	Explanation and action
BACKCRD		BEXT, PORT, TERM, TIF or NIL	<i>Back card element class.</i> If the entry in field FRONTPEC is NIL, enter this refinement. Enter the element group of the card that is on the back side of the card slot.
BACKPEC		NT9X21AB, NT9X26AA, NT9X26AB, NT9X26CA, NT9X62AA, NT9X88AA, NT9X89AA or NIL	<i>Back card PEC.</i> If the entry in field FRONTPEC is NIL, enter data in this subfield. If the entry in subfield BACKCRD is BEXT, enter NT9X89AA. If the entry in subfield BACKCRD is PORT, enter NT9X62AA or NT9X88AA. If the entry in subfield BACKCRD is TERM, enter NT9X21AB. If the entry in subfield BACKCRD is TIF, enter NT9X26AA, NT9X26AB or NT9X26CA. If the entry in subfield BACKCRD is NIL, enter NIL. The card slot is empty or has a filler card.

Datavill example

Sample datavill for table APCDINV appears in the following example.

MAP example for table APCDINV

SMNTYPE	SMNNO	SHELF	SLOT	FRONTCRD	FRONTPEC
BACKCRD		BACKPEC			
AP	0	1	13	CPU	NT9X13LA
TIF	NT9X26CA				

Table history

BCS33

Table APCDINV was introduced in BCS33.

APINV

Table name

Application Processor Inventory Table

Functional description

Table APINV contains information about file processors (FPs) and application processors (APs) on a DMS SuperNode switch. Table APINV contains the following:

- the type and instance of a processor
- the location of the processor
- the link and software configuration data. The resource processor (RP) MAP facility and the Integrated Node Maintenance (INM) software require this data.

The standard table editor provides user interface to access the data in table APINV.

The other tables do not transmit data to table APINV. Tables APCDINV, FPDIPINV, FPDEVINV and PMLOADS are related to table APINV.

Datafill sequence and meaning

Enter data in the following tables before you enter data in table APINV:

- MSCDINV
- PMLOADS
- APINV

The entry in field LOADNAME of table APINV must match the entry in field LOADNAME of table PMLOADS.

Table size

Memory for table APINV has a dynamic definition. The maximum size of table APINV is 200 tuples. The number of nodes in table APINV determines the data store required. This condition occurs because the system automatically adds most data in table APCDINV. The system adds the data when you enter data in table APINV. Each AP requires 250 words of data store. Each FP requires 250 words of data store and an additional 150 words. The additional 150 words are for the addition of cards not on the same shelf or quadrant as the FP.

APINV (continued)**Datafill**

Datafill for table APINV appear in the following table.

Field descriptions (Sheet 1 of 2)

Field	Subfield or refinement	Entry	Explanation and action
SMNTYPE		AP or FP	<i>Sync-matched node type.</i> Enter AP to indicate an application processor. Enter FP to indicate a file processor. This key is the first of a two-part key.
SMNNO		0 to 99	<i>Sync-matched node instance number.</i> Enter the instance number of the resource processor (RP). This key is the second of a two-part key.
FUNCTION		alphanumeric (vector of a maximum of 12 characters)	<i>Sync-matched node function.</i> Enter a string of characters to identify the function of the RP at the standard table editor level on the MAP display.
LOADNAME		alphanumeric (vector of a maximum of 8 characters)	<i>Default loadfile name.</i> Enter the name of the file that system-initiated reload recovery operations loaded into the RP. This name is the default loadfile name when a technician issues the LOADPM command. The technician issues the command at the PM level of a MAP terminal. This file must be in table PMLOADS. This file must be on a permanent device and not a tape device.
SELFLOAD		Y or N	<i>Self-loading capability.</i> Enter Y to indicate the RP has self-loading ability when the system initiates a system recovery action. The RP has this ability when operating company personnel issue the LOADPM command at the PM level of the MAP terminal.
FLOOR		0 to 99	<i>Floor position.</i> Enter the floor number of the cabinet that contains the RP.
ROW		A to Z or AA to ZZ (except I, O, II and OO)	<i>Row position.</i> Enter the row position of the cabinet that contains the RP.
FRAME		0 to 99	<i>Frame position.</i> Enter the frame position in the RP row.

APINV (continued)

Field descriptions (Sheet 2 of 2)

Field	Subfield or refinement	Entry	Explanation and action
SHELF		0 to 3	<i>Shelf number.</i> Enter the shelf number that contains the RP. Shelves are numbered from bottom to top. The numbers begin at 0.
SHELFPEC		NT9X81AA	<i>Shelf product engineering code.</i> Enter the product engineering code (PEC) of the shelf that contains the RP.
QUADRANT		0 to 3	<i>Quadrant range.</i> Enter the quadrant range of the RP. An RP can be in quadrant ranges 0 to 1 or 2 to 3. Enter 0 or 1 for the first quadrant range. Enter 2 or 3 for the second quadrant range.
LINKRATE		R128 or R256	<i>Link rate.</i> Enter the bandwidth on the fiber that connects the RP to the DMS-bus. The bandwidth is the number of channels.
LINKS		see subfields	<i>SMN port configuration.</i> This field is a vector that contains one or more entries of subfields TCARDNO, TLINKNO, DNODENO, DCARDNO and DLINKNO. Each subfield describes the location of one link on the node. Each subfield also describes the place that the link connects to the DMS-bus. Terminate the vector with a \$.
	TCARDNO	1 to 38	<i>Terminating card number.</i> Enter the card number of the terminating link on the node.
	TLINKNO	0 to 1	<i>Terminating link number.</i> Enter the link number of the terminating link on the node, with regard to the card on which the link terminates. The card is an entry in subfield TCARDNO.
	DNODENO	0 to 1	<i>DMS-bus node number.</i> Enter the DMS message switch (MS) node number to which the link connects.
	DCARDNO	1 to 26	<i>DMS-bus card number.</i> Enter the card number of the destination link on the MS.
	DLINKNO	0 to 7	<i>DMS-bus link number.</i> Enter the link number of the destination link on the card.

APINV (end)

Datavill example

Sample datavill for table APINV appears in the following example.

MAP example for table APINV

```
SMNTYPE  SMNNO    FUNCTION  LOADNAME  SELFLOAD  FLOOR
ROW      FRAME   SHELF
SHELFPEC QUADRANT LINKRATE
          LINKS
-----
AP        0        LTS        LTS28IS   N          3
R         7        1
NT9X81AA  0        R256
(12 0 0 15 0) (15 0 1 15 0) (12 1 1 16 0) (15 1 0 16 0)
$
```

Table history

BCS36

The range of values for field LINKRATE is now correct. Values R64 and DS512 are deleted in BCS36.

BCS33

Table APINV was introduced in BCS33.

AREACODE

Table name

Service Switching Point Area Code Table

Functional description

Table AREACODE is used to store area codes in the service area of a service switching point (SSP).

The area codes listed are the area codes of subscriber lines serviced by the SSP. These subscriber lines include lines on other SSPs when the subscriber accesses the virtual private network (VPN) through the serving SSP.

Datafill sequence and implications

There is no requirement to datafill other tables prior to table AREACODE.

Table size

0 to 32 767 tuples

Datafill

The following table lists datafill for table AREACODE.

Field descriptions

Field	Subfield or refinement	Entry	Explanation and action
AREACODE		numeric (1 to 18 digits)	<i>Area code</i> Enter the area code number.
LENGTH		1 to 18	<i>Area code digit length</i> Enter the number of digits used in field AREACODE for the area code number entered. Note: 0 (zero) is not a valid entry for this field.

Datafill example

The following example shows sample datafill for table AREACODE.

AREACODE (end)

MAP display example for table AREACODE

AREACODE	LENGTH
519	3
967967	6
1239996668881212	16

ATTOPTNS

Table name

Automatic Trunk Test Sequence Option (ATTOPTNS)

Functional description

Table ATTOPTNS contains the automatic trunk test control data that does not pertain to specific trunk groups. All automatic trunk tests are classified into one of quarterly tests, periodic tests, ATME No. 2 tests (used by DMS-300 Gateway switching units), manual tests (entered from automatic Trunk Test level of MAP terminal) and non-standard tests. All tests from the ATTSCHED table use this table.

Note: For ATME tests (TA01-TA25), tables D3MAINTD and ATMEQ specify the maintenance and immediate action limits used for loss measurements, but this table must be datafilled with default values to satisfy table control. The entry in field NMLTA is not used for ATME, but must be datafilled to satisfy table control.

For those ATME tests that fall into both operational and transmission classes, the log is output if either of the criteria is satisfied.

Table size

Memory is allocated for a maximum of 12 entries in the table.

ATTOPTNS (continued)**Field descriptions**

The following table describes field names, subfield names, and valid data ranges for table ATTOPTNS.

(Sheet 1 of 5)

Field	Subfield or refinement	Entry	Explanation and action
TSTCLASS		NSTD, PERD, PERD1, ATME, ATME1, MAN, MAN1, MAN2, MAN3, MAN4, QUAR, SYR	<p>TEST CLASS NAME. Enter the test class name as follows:</p> <ul style="list-style-type: none"> • periodic (PERD, PERD1) • quarterly (QUAR) • manual (MAN, MAN1, MAN2, MAN3, MAN4) • non-standard (NSTD) • semi-yearly (SYR) • ATME No. 2 (ATME, ATME1)
TRNSMOUT		ALLTR, ALLTRFL, Q1T, Q2T	<p>TRANSMISSION OUTPUTS. Enter the type of logging required for transmission tests as follows:</p> <ul style="list-style-type: none"> • log all trunks, including passes and those that exceed the maintenance or immediate action noise limits (ALLTR) • log only transmission failures (ALTRFL) • log only trunks that exceed the maintenance or immediate action noise limits (Q1T) • log only the trunks that exceed the immediate action noise limits (Q2T) <p>Note: Transmission tests are MXAM, MXAN, MXRM, MXRN, MXWM, MXWN, N100, S100, S104, TART, TA01, TA02, TA03, TA04, TA05, TA07, TA08, TA09, TA10, TA11, TA14, TA15, TA16, TA17, TA18, TA20, TA21, TA22, TA23, TA24, TERL, TLPA, TLPB, TL0N, TL0S, TL05, TL6N, TL6S, TL65, TSBT, T100, T102, T104, T105, T165, T5AS, T5AT, T5BS, T5LB, T5LH, T50L, T56N, MXPW, MXRV, or MXRC.</p>

ATTOPTNS (continued)

(Sheet 2 of 5)

Field	Subfield or refinement	Entry	Explanation and action
OPEROUT		ALLOP, FAILOP	<p>OPERATIONAL OUTPUTS. Enter the type of logging required for operational tests as follows:</p> <ul style="list-style-type: none"> log all trunks, including passes (ALLOP) log only the trunks that fail operational tests (FAILOP) <p>Note: Operational tests are DIAG, TA06, TA07, TA08, TA09, TA10, TA11, TA12, TA13, TA14, TA15, TA16, TA17, TA18, TA19, TA20, TA21, TA22, TA23, TA24, TA25, TE_M, TNSS, TR2L, TR2S, TSBS, TSYN, TS05, TS65, T103, T5SB, MXOR, or MXTM.</p>
Q1LIMIT		0-99	TRANSMISSION MAINTENANCE TEST LIMIT. Enter the transmission maintenance test limit in 0.1 db steps (0-9.9 db). The standard value is 1.7 db.
Q2LIMIT		0-99	TRANSMISSION IMMEDIATE ACTION TEST LIMIT. Enter the transmission immediate action test limit in 0.1 db steps (0-9.9 db). The standard value is 3.7 db.
Q1L404		0-99	TRANSMISSION MAINTENANCE TEST LIMIT. Enter the transmission maintenance test limit in 0.1db steps (0-9.9db) for loss measurements at -16 db and 404 Hz.
Q2L404		0-99	TRANSMISSION IMMEDIATE ACTION TEST LIMIT. Enter the transmission immediate action test limit in 0.1db steps (0-9.9 db) for loss measurements at -16 db and 404 Hz.
Q1L1004		0-99	TRANSMISSION MAINTENANCE TEST LIMIT. Enter the transmission maintenance test limit in 0.1db steps (0-9.9 db) for loss measurements at -16 db and 1004 Hz.

ATTOPTNS (continued)

(Sheet 3 of 5)

Field	Subfield or refinement	Entry	Explanation and action
Q2L1004		0-99	TRANSMISSION IMMEDIATE ACTION TEST LIMIT. Enter the transmission immediate action test limit in 0.1 db steps (0-9.9 db) for loss measurements at -16 db and 1004 Hz.
Q1L2804		0-99	TRANSMISSION MAINTENANCE TEST LIMIT. Enter the transmission maintenance test limit in .1db steps (0-9.9 db) for loss measurements at -16 db and 2804 Hz.
Q2L2804		0-99	TRANSMISSION IMMEDIATE ACTION TEST LIMIT. Enter the transmission maintenance test limit in 0.1 db steps (0-9.9 db) for loss measurements at -16 db and 2804 Hz.
NMLTA		0-99	NOISE MAINTENANCE AND IMMEDIATE ACTION LIMIT CORRECTION. Enter the value to be added to the noise maintenance and immediate action limits in 1 dBRN steps (0-99 dBRN) for noise with tone measurement (C- notched filter).
WAITTIME		0-7	WAIT TIME. Enter the length of time in minutes to wait for busy trunks to become available for test when testing has been suspended because no trunks are available.

ATTOPTNS (continued)

(Sheet 4 of 5)

Field	Subfield or refinement	Entry	Explanation and action
RETSTSET		TSTPASS, SIG_FAIL, BSY_FLASH_FAIL MEAS_Q1_FAIL, MEAS_Q2_FAIL, BSY_NE, BSY_FE, INST_INTER, MISC_FAIL, ALL	<p>RETEST SET. If test class name is ATME and field RETEST is equal to Y, the retest is done if the reason for failure is found in this set; otherwise, the retest is not done.</p> <p>Enter one or more reasons for failure as follows. Each reason for failure must be separated from each other by a blank column. If the set is continued on the next record, enter + preceded by a blank column and enter the next member of the set on the next record. If the set of reasons is complete, enter \$ preceded by a blank column to indicate the end of the set. Enter ALL, if there are no restrictions on the reasons for failure. If test class name is not ATME, enter ALL to satisfy table control.</p> <ul style="list-style-type: none"> • SIG_FAIL (signaling failure) • BSY_FLASH_FAIL (busy flash test failure) • MEAS_Q1_FAIL (transmission, exceeded Q1) • MEAS_Q2_FAIL (transmission, exceeded Q2) • BSY_NE (near end busy) • BSY_FE (far end busy) • INST_INTER (instability, interm) • MISC_FAIL (misc failures)
RETEST		Y or N	<p>RETEST ON FAILURE. If a circuit is to be retested on a test failure, enter Y; otherwise, enter N.</p>

ATTOPTNS (end)

(Sheet 5 of 5)

Field	Subfield or refinement	Entry	Explanation and action
REMOVE		Y or N	REMOVE FROM SERVICE. Where a circuit is to be removed from service on a test failure, enter Y; otherwise, enter N. Note: Trunks removed from service are set to a manual busy state.
RMV25PC		Y or N	REMOVE FROM SERVICE CHECK. If the maximum percentage of trunks that can be removed from service is 50, enter N. If the maximum percentage of trunks that can be removed from service is 25, enter Y.

Datafill example

The following example shows a periodic sequence that logs all transmission tests that exceed maintenance limits and that fail operational tests for a local or local toll switch.

TSTCLASS	TRNSMOUT	OPEROUT	Q1LIMIT	Q2LIMIT		
Q1L404	Q2L404	Q1L1004	Q2L1004	Q1L2804	Q2L2804	NMLTA
WAITTIME	RETSTSET	RETEST	REMOVE	RMV25PC	MQIDX	
PERD	Q1T	FAILOP	17	37		
17	17	37	17	37	37	17
1	ALL	Y	Y	N		8

ATTSCHEDED**Table name**

Automatic Trunk Test Group Schedule (ATTSCHEDED)

Functional description

Table ATTSCHEDED lists data for each outgoing or two-way trunk group that requires automatic trunk testing.

As shown in the following table, the type of test to be performed is indicated by a T for transmissions or by an O for operational.

(Sheet 1 of 4)

Test	Description
DIAG	Diagnostic. Circuit check. (O)
MXAM	Invokes the audio loop test. Far/Near and Near/Far noise measurements are performed. Loop loss measurements are performed. Loss measurements are made with a 0 dBm 1004 Hz tone. Noise measurements are made with a C-message filter. (T)
MXAN	Invokes the wire loop test. Far/Near and Near/Far noise measurement are performed. Loop loss measurements are performed. Loss measurements are made with a -16 dBm 1004 Hz tone. Noise measurements are made with a C-notch filter. (T)
MXRM	Invokes the RF loop test. Far/Near and Near/Far loss and noise measurements are performed. Loss measurements are made with a 0 dBm 1004 Hz tone. Noise measurements are made with a C-message filter. (T)
MXRN	Invokes the RF loop test. Far/Near and Near/Far loss and noise measurements are performed. Loss measurements are made with a -16 dBm 1004 Hz tone. Noise measurements are made with a C-notch filter. (T)
MXWM	Invokes the wire loop test. Far/Near and Near/Far loss and noise measurement are performed. Loss measurements are made with a 0 dBm 1004 Hz tone. Noise measurements are made with a C-message filter. (T)
MXWN	Invokes the wire loop test. Far/Near and Near/Far loss and noise measurement are performed. Loss measurements are made with a -16 dBm 1004 Hz tone. Noise measurements are made with a C-notch filter. (T)
N100	Balance and Milliwatt. Far to near loss and noise measurement. (T)

ATTSCHEDED (continued)

(Sheet 2 of 4)

Test	Description
S100	Balance Test Line. Far to near noise measurement. (T)
TE_M	E and M Lead. (O)
TERL	105 Originating Test Line. Echo return loss measurement. (T)
TLPA	Loop Around. Loss measurement in both directions. (T)
TL0N	105 Originating Test Line. Loss measurement at 0db and 1004 Hz and noise measurement. (T)
TL0S	105 Originating Test Line. Loss measurement with self check at 1004 Hz and 0 db. (T)
TL05	105 Originating Test Line. Loss measurement at 1004 Hz and 0 db. (T)
TL6N	105 Originating Test Line. Loss measurement at 404, 1004, and 2804 Hz at -16 db and noise measurement with tone. (T)
TL6S	105 Originating Test Line. Loss measurement with self check at 404, 1004 and 2804 Hz at -16 db. (T)
TL65	105 Originating Test Line. Loss measurement at 404, 1004 and 2804 Hz at -16 db. (T)
TNSS	Non-Synchronous. (O)
TR2L	Repeat Two (long delay). (O)
TR2S	Repeat Two (short delay). (O)
TR2S	Repeat Two (short delay). (O)
TSBS	105 Originating Test Line. Loss self check at -16 db and 404, 1004, and 2804 Hz. Noise self check (c-notched filter.) Return loss self check. (O)
TSBT	105 Originating Test Line. Return loss measurement. (T)
TSYN	Synchronous. (O)
TS05	105 Originating Test Line. Far end loss self check and far end noise self check. (O)
TS65	105 Originating Test Line. Far end loss self check at 404, 1004 and 2804 Hz at -16 db and far end noise self check (c-notched). (O)

ATTSCHEID (continued)

(Sheet 3 of 4)

Test	Description
T100	Combined S100 and N100 tests. (T)
T102	Milliwatt. Far to near loss measurement. (T)
T103	Non-synchronous. (O)
T104	104 Test. Loss measurement in both directions, noise measurement far end to near end and noise check near end to far end. (T)
T105	105 Originating Test Line. Loss measurement with self check at 0 db and 1004 Hz and noise measurement with self check. (T)
T165	105 Originating Test Line. Loss measurement at 404, 1004 and 2804 Hz at -16 db with self check and noise measurement with tone (c-notched) with self check. (T)
T5AS	105 Originating Test Line. Loss measurement and self check at 0 db and 1004 Hz. Noise measurement and self check (c-message filter). Return loss measurement and self check. (T)
T5AT	105 Originating Test Line. Loss measurement at 0 db and 1004 HZ. Noise measurement (c-message filter). Return loss measurement. (T)
T5BS	105 Originating Test Line. Return loss measurement and self check. (T)
T5LB	105 Originating Test Line. Loss measurement at -16 db and 404, 1004, and 2804 Hz. Return loss measurement. (T)
T5LH	105 Originating Test Line. Singing return loss (low and high) measurement. (T)
T5SB	105 Originating Test Line. Return loss self check. (O)
T50L	105 Originating Test Line. Loss measurement at 0 db and 1004 Hz. Return loss measurement. (T)
T56N	105 Originating Test Line. Loss measurement at -16 db and 404, 1004, 2804 Hz. Noise measurement (c-notched filter.) Return loss measurement. (T)
MXOR	Mobile originations with landside disconnect. (O)
MXTM	Mobile terminations with landside disconnect. (T)
MPXW	Power measurements on voice channels. (T)

ATTSCHEDED (continued)

(Sheet 4 of 4)

Test	Description
MXRV	RSSI measurements performed by voice channels and locating receivers. (T)
MXRC	RSSI measurements performed by control channels. (T)

The tests not applicable to automatic trunk testing are as follows:

Test	Description
S104	104 Test. Loss measurement in both directions. (T)
TCLC	Short Circuit Test Line. Manual test only. (O)
TCON	CCIS Continuity Test. (O)
TCOT	CCIS#6 Continuity Test. (O)
TLPB	Loop Around. Manual test only. (T)
TOPC	Open Circuit Test Line. Manual test only. (O)
TS31	Reserved for future use.
T106	Reserved for future use.
T107	Reserved for future use.
T108	Echo Suppressor Test. Manual test only. (O)
T109	Reserved for future use.

Datafill sequence and implications

Table CLLI must be datafilled before table ATTSCHEDED.

Table size

Memory is automatically allocated for 8,191 (CLLI, TESTNAME) combinations.

ATTSCHEDED (continued)**Field descriptions**

The following table describes field names, subfield names, and valid data ranges for table ATTSCHEDED.

(Sheet 1 of 3)

Field	Subfield or refinement	Entry	Explanation and action
ATTKEY		CLLI and TESTNAME	AUTOMATIC TRUNK TEST KEY.
	CLLI	alphanumeric	COMMON LANGUAGE LOCATION IDENTIFIER. Enter the code of the outgoing or two-way trunk group requiring test.
	TESTNAME	alphanumeric	TEST NAME. Enter the name of the type of test to be performed on the outgoing or two-way trunk group specified in subfield CLLI.
ABORTGRP		Y or N	ABORT GROUP. Enter Y when testing of trunk group is not required; otherwise, enter N.

ATTSCHEDED (continued)

(Sheet 2 of 3)

Field	Subfield or refinement	Entry	Explanation and action
TSTSCHED		alphanumeric	<p>TEST SCHEDULE. Enter the frequency and time that test is to be performed. Frequencies are as follows:</p> <ul style="list-style-type: none"> • HRY (hourly) • DLY (daily) • EDY (even days only) • ODY (odd days only) • WKY (weekly) • EWK (even weeks only) • OWK (odd weeks only) • MTH (monthly) • QTR (quarterly) • DYOM (day of month) • EVM (even months only) • ODM (odd months only) • IQT (international quarterly) • SAN (semi-yearly)
MAXTEST		0-999	<p>MAXIMUM TEST TIME. Enter the maximum length of time, in ten minute intervals, a test is to be run. An entry of 0 (zero) means no limit.</p>

ATTSCHE (continued)

(Sheet 3 of 3)

Field	Subfield or refinement	Entry	Explanation and action
TESTDLY		S, L, MEDDLY, or EXLONGDLY	TEST DELAY. If the length of the delay for the far end to drop, in a test line test is one second, enter S (short). For a 6-second delay, enter MEDDLY (medium delay). For a 9-second delay, enter L (long) and for a 15-second delay, enter EXLONGDLY (extra long delay).
TSTSEQ		NSTD, PERD, PERD1, ATME, ATME1, MAN, MAN1, MAN2, MAN3, MAN4, QUAR, SYR	TEST SEQUENCE. Enter the test class name that indexes in table OPTOPTNS and contains the automatic trunk test control data that does not pertain to specific trunk groups: periodic (PERD, PERD1), quarterly (QUAR), manual (MAN, MAN1, MAN2, MAN3, MAN4), non-standard (NSTD), semi-yearly (SYR) or ATME No.2 (ATME, ATME1)

Field descriptions for hourly test (HRY)

If test has to be performed hourly, complete field TSTSCHE as follows.

Field	Subfield or refinement	Entry	Explanation and action
TSTSCHE		ATTINTVL, MIN	AUTOMATIC TRUNK TEST SCHEDULE
	ATTINVL	HRY	AUTOMATIC TRUNK TEST INTERVAL. Enter hourly (HRY) for the automatic trunk test interval.
	MIN	0-59	MINUTE. Enter the minute during the hour that the test has to commence.

ATTSCHEDED (continued)

Field descriptions for daily test (DLY)

If test has to be performed daily, complete field TSTSCHEDED as follows.

Field	Subfield or refinement	Entry	Explanation and action
TSTSCHEDED		ATTINTVL, HOUR, MIN	AUTOMATIC TRUNK TEST SCHEDULE
	ATTINTVL	DLY	AUTOMATIC TRUNK TEST INTERVAL. Enter daily (DLY) for the automatic trunk test interval.
	HOUR	0-23	HOUR. Enter the hour during the day that the test has to commence.
	MIN	0-59	MINUTE. Enter the minute during the hour that the test has to commence.

Field descriptions for tests on even days only (EDY)

If test has to be performed on even days only, complete field TSTSCHEDED as follows.

Field	Subfield or refinement	Entry	Explanation and action
TSTSCHEDED		ATTINTVL, HOUR, MIN	AUTOMATIC TRUNK TEST SCHEDULE
	ATTINTVL	EDY	AUTOMATIC TRUNK TEST INTERVAL. Enter even days only (EDY) for the automatic trunk test interval.
	HOUR	0-23	HOUR. Enter the hour during the even day that the test has to commence.
	MIN	0-59	MINUTE. Enter the minute during the hour on the even day that the test has to commence.

ATTSCHEDED (continued)**Field descriptions for tests on odd days only (ODY)**

To perform a test on odd days, complete field TSTSCHEDED as follows.

Field	Subfield or refinement	Entry	Explanation and action
TSTSCHEDED		ATTINTVL, HOUR, MIN	AUTOMATIC TRUNK TEST SCHEDULE
	ATTINTVL	ODY	AUTOMATIC TRUNK TEST INTERVAL. Enter odd days only (ODY) for the automatic trunk test interval.
	HOUR	0-23	HOUR. Enter the hour during the odd day that the test has to commence.
	MIN	0-59	MINUTE. Enter the minute during the hour on the odd day that the test has to commence.

Field descriptions for weekly tests (WKY)

To perform a weekly test, complete field TSTSCHEDED as follows.

Field	Subfield or refinement	Entry	Explanation and action
TSTSCHEDED		ATTINTVL, DAYOFWK, HOUR, MIN	AUTOMATIC TRUNK TEST SCHEDULE
	ATTINTVL	WKY	AUTOMATIC TRUNK TEST INTERVAL. Enter weekly (WKY) for the automatic trunk test interval.
	DAYOFWK	0-6	DAY OF WEEK. Enter the day of the week, that the test has to be performed. Monday=0, Tuesday=1, Wednesday=2, Thursday=3, Friday=4, Saturday=5, Sunday=6.
	HOUR	0-23	HOUR. Enter the hour during the day of the week that the test has to commence.
	MIN	0-59	MINUTE. Enter the minute during the hour on the day of the week that the test has to commence.

ATTSCHEDED (continued)

Field descriptions for tests during even weeks only (EWK)

If test has to be performed during even weeks only, complete field TSTSCHEDED as follows.

Field	Subfield or refinement	Entry	Explanation and action
TSTSCHEDED		ATTINTVL, DAYOFWK, HOUR, MIN	AUTOMATIC TRUNK TEST SCHEDULE
	ATTINTVL	EWK	AUTOMATIC TRUNK TEST INTERVAL. Enter even weeks only (EWK) for the automatic trunk test interval.
	DAYOFWK	0-6	DAY OF WEEK. Enter the day during the week the to perform the test: Monday=0, Tuesday=1, Wednesday=2, Thursday=3, Friday=4, Saturday=5, Sunday=6.
	HOUR	0-23	HOUR. Enter the hour during the day of the even week that the test has to commence.
	MIN	0-59	MINUTE. Enter the minute of the hour on the day of the even week that the test has to commence.

Field descriptions for tests during odd weeks only (OWK)

If test has to be performed during odd weeks only, complete field TSTSCHEDED as follows.

(Sheet 1 of 2)

Field	Subfield or refinement	Entry	Explanation and action
TSTSCHEDED		ATTINTVL, DAYOFWK, HOUR, MIN	AUTOMATIC TRUNK TEST SCHEDULE
	ATTINTVL	OWK	AUTOMATIC TRUNK TEST INTERVAL. Enter odd weeks only (OWK) for the automatic trunk test interval.

ATTSCHEDED (continued)

(Sheet 2 of 2)

Field	Subfield or refinement	Entry	Explanation and action
	DAYOFWK	0-6	DAY OF WEEK. Enter the day during the odd week that the test has to be performed. Monday=0, Tuesday=1, Wednesday=2, Thursday=3, Friday=4, Saturday=5, Sunday=6.
	HOUR	0-23	HOUR. Enter the hour during the day of the odd week that the test has to commence.
	MIN	0-59	MINUTE. Enter the minute of the hour on the day of the odd week that the test has to commence.

Field descriptions for monthly tests (MTH)

If test has to be performed monthly, complete field TSTSCHEDED as follows.

(Sheet 1 of 2)

Field	Subfield or refinement	Entry	Explanation and action
TSTSCHEDED		ATTINTVL, WOM, DOFWK, HOUR, MIN	AUTOMATIC TRUNK TEST SCHEDULE
	ATTINTVL	MTH	AUTOMATIC TRUNK TEST INTERVAL. Enter monthly (MTH) for the automatic trunk test interval.
	WOM	1-5	WEEK OF MONTH. Enter the week of the month on which the test has to be performed. Week 1 is the first whole week of a month beginning with a Monday. Week 4 or 5 can include days belonging to the following month.
	DOFWK	0-6	DAY OF WEEK. Enter the day during the week on which the test has to be performed. Monday=0, Tuesday=1, Wednesday=2, Thursday=3, Friday=4, Saturday=5, Sunday=6.

ATTSCHEDED (continued)

(Sheet 2 of 2)

Field	Subfield or refinement	Entry	Explanation and action
	HOUR	0-23	HOUR. Enter the hour during the day of the month that the test has to commence.
	MIN	0-59	MINUTE. Enter the minute of the hour on the day of the month that the test has to commence.

Field descriptions for quarterly tests (QTR)

If test has to be performed quarterly, complete field TSTSCHEDED as follows.

Field	Subfield or refinement	Entry	Explanation and action
TSTSCHEDED		ATTINTVL, MOFQTR, DAYOFM, HOUR, MIN	AUTOMATIC TRUNK TEST SCHEDULE
	ATTINTVL	QTR	AUTOMATIC TRUNK TEST INTERVAL. Enter quarterly (QTR) for the automatic trunk test interval.
	MOFQTR	0-2	MONTH OF QUARTER. Enter the month of the quarter during which the test has to be performed.
	DAYOFM	1-31	DAY OF MONTH. Enter the day of the month on which the test has to be performed.
	HOUR	0-23	HOUR. Enter the hour during the day of the month that the test has to commence.
	MIN	0-59	MINUTE. Enter the minute of the hour on the day of the month that the test has to commence.

ATTSCHEDED (continued)**Field descriptions for tests on specific days of the month (DYOM)**

If test has to be performed on specific days of the month, complete field TSTSCHEDED as follows.

Field	Subfield or refinement	Entry	Explanation and action
TSTSCHEDED		ATTINTVL, DAYOFM, HOUR, MIN	AUTOMATIC TRUNK TEST SCHEDULE
	ATTINTVL	DYOM	AUTOMATIC TRUNK TEST INTERVAL. Enter day of month (DYOM) for the automatic trunk test interval.
	DAYOFM	1-31	DAY OF MONTH. Enter the day of the month (0-31) when the test has to be performed.
	HOUR	0-23	HOUR. Enter the hour during the day of the week that the test has to commence.
	MIN	0-59	MINUTE. Enter the minute of the hour on the day of the month that the test has to commence.

Field descriptions for tests during even months (EVM)

If test has to be performed during even months only, complete field TSTSCHEDED as follows.

(Sheet 1 of 2)

Field	Subfield or refinement	Entry	Explanation and action
TSTSCHEDED		ATTINTVL, WOM, DOFWK, HOUR, MIN	AUTOMATIC TRUNK TEST SCHEDULE
	ATTINTVL	EVM	AUTOMATIC TRUNK TEST INTERVAL. Enter even month (EVM) for the automatic trunk test interval. An even month denotes February, April, June, and so on.

ATTSCHEDED (continued)

(Sheet 2 of 2)

Field	Subfield or refinement	Entry	Explanation and action
	WOM	1-5	WEEK OF MONTH. Enter the week of the month on which the test has to be performed. Week 1 is the first whole week of a month beginning with a Monday. Week 4 or 5 can include days belonging to the following month.
	DOFWK	0-6	DAY OF WEEK. Enter the day during the week on which the test has to be performed. Monday=0, Tuesday=1, Wednesday=2, Thursday=3, Friday=4, Saturday=5, Sunday=6.
	HOUR	0-23	HOUR. Enter the hour during the day of the week, that the test has to commence.
	MIN	0-59	MINUTE. Enter the minute of the hour on the day of the week that the test has to commence.

Field descriptions for tests during odd months (ODM)

If test has to be performed odd months only, complete field TSTSCHEDED as follows.

(Sheet 1 of 2)

Field	Subfield or refinement	Entry	Explanation and action
TSTSCHEDED		ATTINTVL, WOM, DOFWK, HOUR, MIN	AUTOMATIC TRUNK TEST SCHEDULE
	ATTINTVL	ODM	AUTOMATIC TRUNK TEST INTERVAL. Enter odd month (ODM) for the automatic trunk test interval.
	WOM	1-5	WEEK OF MONTH. Enter the week of the month on which the test has to be performed. Week 1 is the first whole week of a month beginning with a Monday. Week 4 or 5 can include days belonging to the following month.

ATTSCHED (continued)

(Sheet 2 of 2)

Field	Subfield or refinement	Entry	Explanation and action
	DOFWK	0-6	DAY OF WEEK. Enter the day during the week on which the test has to be performed. Monday=0, Tuesday=1, Wednesday=2, Thursday=3, Friday=4, Saturday=5, Sunday=6.
	HOUR	0-23	HOUR. Enter the hour during the day of the week, that the test has to commence.
	MIN	0-59	MINUTE. Enter the minute of the hour on the day of the week that the test has to commence.

Field descriptions for tests during an international quarter

If test has to be performed during an international quarter, complete field TSTSCHE

D as follows.

(Sheet 1 of 2)

Field	Subfield or refinement	Entry	Explanation and action
TSTSCHED		ATTINTVL, MOFQTR, WOM, DOFWK, HOUR, MIN	AUTOMATIC TRUNK TEST SCHEDULE
	ATTINTVL	IQT	AUTOMATIC TRUNK TEST INTERVAL. Enter international quarter (IQT) for the automatic trunk test interval.
	MOFQTR	0-2	MONTH OF QUARTER. Enter the month of the quarter during which the test has to be performed.
	WOM	1-5	WEEK OF MONTH. Enter the week of the month on which the test has to be performed. Week 1 is the first whole week of a month beginning with a Monday. Week 4 or 5 can include days belonging to the following month.

ATTSCHEDED (continued)

(Sheet 2 of 2)

Field	Subfield or refinement	Entry	Explanation and action
	DOFWK	0-6	DAY OF WEEK. Enter the day during the week on which the test has to be performed. Monday=0, Tuesday=1, Wednesday=2, Thursday=3, Friday=4, Saturday=5, Sunday=6.
	HOUR	0-23	HOUR. Enter the hour during the day of the week, that the test has to commence.
	MIN	0-59	MINUTE. Enter the minute of the hour on the day of the week that the test has to commence.

Field descriptions for semi-yearly tests (SAN)

If test has to be performed semi-yearly, complete field TSTSCHEDED as follows.

(Sheet 1 of 2)

Field	Subfield or refinement	Entry	Explanation and action
TSTSCHEDED		ATTINTVL, MOFSY, WOM, DOFWK, HOUR, MIN	AUTOMATIC TRUNK TEST SCHEDULE
	ATTINTVL	SAN	AUTOMATIC TRUNK TEST INTERVAL. Enter semi-yearly (SAN) for the automatic trunk test interval.
	MOFSY	1-6	MONTH OF SEMI-YEAR. Enter the month of the semi-year on which the test has to be performed.
	WOM	1-5	WEEK OF MONTH. Enter the week of the month on which the test has to be performed. Week 1 is the first whole week of a month beginning with a Monday. Week 4 or 5 can include days belonging to the following month.

ATTSCHEDED (end)

(Sheet 2 of 2)

Field	Subfield or refinement	Entry	Explanation and action
	DOFWK	0-6	DAY OF WEEK. Enter the day during the week on which the test has to be performed. Monday=0, Tuesday=1, Wednesday=2, Thursday=3, Friday=4, Saturday=5, Sunday=6.
	HOUR	0-23	HOUR. Enter the hour during the day of the week, that the test has to commence.
	MIN	0-59	MINUTE. Enter the minute of the hour on the day of the week that the test has to commence.

Datafill example

The following is an example of datafill for a local or local/toll switch for the ATTSCHEDED table. The example consists of the following.

- an inactive milliwatt transmission test schedule for a trunk group with a CLLI of OTWAON232370

The test is scheduled monthly and is to commence one minute past the hour of 2:00 on the first day of the month. The maximum length of time for the test is 30 minutes. A delay of one second is allowed for the far end to drop. The test sequence pointed to in table ATTOPTNS is PERD.

- an active diagnostic operational test for a trunk group with a CLLI of OTWAON1002T1

The test is scheduled weekly, and is to be performed at one minute past the hour of 1:00 on the second day of every week. The maximum length of time for the test is 20 minutes. A delay of nine seconds is allowed for the far end to drop. The test sequence pointed to in table ATTOPTNS is PERD.

ATTKEY	ABORTKEY	TESTSCHED	MAXTEST	TESTDLY	TSTSEQ
UEAN2WMFWK90	DIAG	N	QTR 1 1	0 S	QUAR

AUDALARM

Table name

Audible Alarm Table

Functional description

This table specifies the alarm level for log reports from the security subsystem. You cannot view and manipulate these reports. You can specify alarm levels for these reports in the following two methods:

- Through the use of table CMDS, you can specify if a report and alarm generates for each command.
- Through the use of table AUDALARM, you can specify an alarm level for logging each report.

Log devices do not print secret alarms. When a secret report causes an alarm, the alarm system generates a non-secret log. This non-secret log only records that an alarmed secret report is logged.

You cannot add or delete tuples from this table with the LOGUTIL facility at the MAP terminal. The LOG system adds tuples automatically at restart time. Each log report has the alarm level set to NA (no alarm) by default. The only correct user operation for this table is to change the alarm level of a report. Changes to the alarm level occur immediately. Restart is not required.

Datafill sequence and meaning

You do not need to enter data in other tables before you enter data in table AUDALARM.

Table size

One tuple is in this table for every secret log in the system.

64 tuples

AUDALARM (end)**Datafill**

Datafill for table AUDALARM appears in the following table.

Field descriptions

Field	Subfield or refinement	Entry	Explanation and action
LOGREP		alphanumeric (a maximum of 16 characters)	<i>Log report.</i> Enter a logname and report number, in the form of logname\$reportnumber, for example, SECU\$101. Only lognames and report numbers of secret logs are keys to this table.
ALARM		CR, MN, MJ, or NA	<i>Alarm level.</i> Enter the level of the alarm that the subsystem raises when a report is logged. The levels are, CR (critical alarm), MN (minor alarm), MJ (major alarm), or NA (no alarm). The entry in this field can only be changed. You cannot add or delete tuples. The default entry for this field is NA. Note: Changes to the alarm level take effect immediately. Restart is not required.

Datafill example

The system automatically inserts tuples in this table for each log report. The alarm level entries for these tuples are always set to the default value NA. The entries required to change the alarm level for log reports appear in the following table. These entries change log report SECU\$109 to major, and the alarm level for log report SECU\$111 to minor.

MAP example for table AUDALARM

LOGREP	ALARM
SECU\$109	MJ
SECU\$111	MN

AUDIO

Table name

Audio Interlude Table

Functional description

Table AUDIO defines the audio interlude broadcasts. These broadcasts are for specified features for the Integrated Business Network (IBN). These broadcasts can include any of the following broadcast elements:

- announcement
- music
- silence
- ringing

Each tuple in the table specifies the audio broadcast issued for an audio group and feature name. The common language location identifier (CLLI) names of the announcement and music trunks appear in table AUDIO. The CLLI names must appear in tables ANN and ANNMEMS also.

Feature AD1128 is Second and Third Delay Announcement. This feature helps to provide a second and third announcement for calls that wait to be answered. With this feature, six different broadcast selections, connection selections, are available.

You can enter six connection selections in the route list. You can enter a total of two delay intervals. These intervals must occur between announcement routes. Subsequent announcements are permitted. You can enter a maximum of six subsequent announcements if delay intervals are not inserted.

The system allows a new route selection, ringing, during the delay time between announcements and the final route selection. If you specify ringing, the system prompts the delay time between announcements. This delay time is the delay threshold. A similar delay threshold field is also added to the music and silence route selectors. If the delay threshold is at 0 (zero), the treatment continues until the line is answered or abandoned. You cannot follow a selection of ringing, silence, or music by another selection of ringing, silence, or music.

Announcement cycles can repeat through the use of option REPEAT. Option repeat is only correct as the final selection. If you use option repeat, specify the route selection that needs to repeat. Only routes 2, 3, and 4 are correct.

Music, silence, or ringing can follow the final announcement. If the final selection is not music, silence, ringing, or repeat, silence is the default. If you

AUDIO (continued)

enter music, silence, or ringing as the final selection, the delay time must be 0 (zero). When you enter music, silence, or ringing with a delay time of 0, you cannot enter any more selections.

You cannot enter delay intervals for attendant consoles. Ringing and repeat options are not allowed. Music and silence are allowed as final choices only.

Announcements in audio interlude always start from the beginning of a cycle. This action applies to calls that arrive over a trunk or line. Some features have a known duration for ringback tone before the features switch to announcement. In these occurrences, the system adds the allowed time the announcement recording uses to reach the beginning of the cycle to the predetermined ringback time. This time is the total time available for ringing before switching. For example, consider the condition where a caller must hear audible ringing for 10 s, an announcement and music. The announcement cycle is 6 s long. If, after 10 s of ringing, the announcement is in mid-cycle, an additional 3 s of ringing is available. After the additional 3 s of ringing, the system switches to the beginning of the announcement.

To prevent cross talk, SILENCE tone must be assigned after the announcement or music CLLI.

Table AUDIO can specify the following features:

- Attendant Camp-on (CAMPON).
For calls the attendant extends to a busy station, this feature defines the broadcast specified before the busy station became idle. The Attendant Camp-on (ACO) feature in table CUSTCONS enables or disables the broadcast.
- Attendant Hold with Audio (ACHOLD).
This feature defines the broadcast specified to calls that the attendant put on hold. The attendant presses the HOLD key or another loop key. The Attendant Hold with Audio (ACHOLD) feature in table CUSTCONS enables or disables the broadcast.
- Attendant Queue (ATTQ).
This feature defines the broadcast specified to calls that waits in the attendant queue. The Music On Hold (MHOLD) feature in table CUSTHEAD enables or disables the broadcast.
- Automatic Call Distribution Queue (ACDQ).
This feature defines the broadcast specified to calls waiting in the queue for each Automatic Call Distribution (ACD) group. The ACD feature in table ACDGRP enables or disables the broadcast.

AUDIO (continued)

If an audio group associated with an ACD public safety answering point (PSAP) group changes, a check runs. This check runs to verify that the AUDIO group does not specify MUSIC as an entry in field CHOICE. This check is done only if the optional E911 ACD software is present. The entry MUSIC is not allowed in an AUDIO group that associates with an ACD PSAP group.

The following warning message appears if an attempt is made to add MUSIC to an ACDQ tuple. The following warning message appears if the associated ACD group has option ACDPSAP entered in table ACDGRP:

```
THE ACD PSAP REFERENCES THE SPECIFIED AUDIO GROUP IN  
TABLE ACDGRP.  MUSIC IS NOT ALLOWED AS AN AUDIO CHOICE.
```

- **Call Hold (CHD).**

This feature defines the broadcast specified to calls put on hold by IBN stations. This feature flashes the hook switch and dials the call-hold access code entered in table IBNXLA for 500/2500 sets to activate the Call Hold. The Call Hold with Music (CHD) feature in table CUSTSTN enables or disables the broadcast.
- **Call Park (CPARK).**

This feature defines the broadcast specified to calls 500/2500 sets and business sets park. This feature flashes the hook switch and dials the call-park access code for 500/2500 sets to activate Call Park. Another method to activate Call Park is to press the key assigned to the Call Park feature for business sets. The Call Park (CPK) feature in table CUSTHEAD enables or disables the broadcast.
- **Call Waiting Originating (CWO).**

For stations with Call Waiting Originating assigned in table IBNLINES, this feature defines the broadcast specified before a busy line becomes idle. The Call Waiting Originating (CWO) feature in table CUSTSTN enables or disables the broadcast.
- **Dial Call Waiting (CWD).**

This feature defines the broadcast specified to stations with Dial Call Waiting (CWD) that waits for a busy line to become idle. The Dial Call Waiting (CWD) feature in table CUSTSTN enables or disables the broadcast.
- **Key Set Music On Hold (KSMOH).**

This feature defines a music broadcast for calls put on hold. Feature KSMOH in table CUSTSTN enables or disables the broadcast. Enter feature KSMOH in table IVDINV for integrated voice and data (IVD) telephones. Enter feature KSMOH in table KSETINV for business sets.

AUDIO (continued)

Table AUDIO supports entry KSMOH in field FTRINDEX for ISDN keysets.

- Meridian Business Set Camp-on (MBSCAMP).

This feature allows feature MBSCAMPO in table CUSTSTN to provide music, announcement, ringing, or silence. These options are for calls to Meridian Business Sets (MBS) that are camped-on. Enter feature MBSCAMP in tables CUSTSTN, KSETFEAT, KSETLINE, LCCOPT, OPTOPT, and REASONS.

- Multiple Position Hunt with Queue (MPHQ).

This feature distributes calls evenly across multiple non-data link attendant consoles. The system presents calls to the consoles in the order that the calls arrive at the DMS-100 Family switch. The DMS-100 switch enqueues calls that the system cannot present to any console. The This feature places these calls in a queue until a console is available to serve that call.

- Permanent Hold (PHOLD).

This feature defines the broadcast specified to calls that IBN stations put on permanent hold. This feature flashes the hook switch and dials the permanent-hold access code in table IBNXLA to activate Permanent Hold. The Permanent Hold (PHOLD) feature in table CUSTSTN enables or disables the broadcast. Feature Permanent Hold is not available to business set stations.

- Single Line Queue (SLQQ).

This feature defines the broadcast specified to calls that wait to be served in the SLQ queue. This feature allows SLQ lines to select an announcement type.

- Uniform Call Distribution Queue (UCDQ).

This feature defines the broadcast specified to calls that wait to be served in the UCD queue. This condition occurs if the predicted delay exceeds the customer preset threshold. The Audio feature in table UCDGRP enables or disables the broadcast.

Datafill sequence and meaning

You must enter data in the following tables before you enter data in table AUDIO:

- CLLI
- ANNS
- ANNMEMS

AUDIO (continued)

Table size

0 to 511 tuples

Table size is a string range. The number of entries in field GROUP determines the table size. You can enter a maximum of 512 audio group names (field GROUP).

Datafill

Datafill for table AUDIO appears in the following table.

Field descriptions (Sheet 1 of 3)

Field	Subfield	Entry	Explanation and action
AUDIOKEY		see subfields	<i>Audio key.</i> This field contains subfields GROUP and FTRINDEX.
	GROUP	AUDIO1to AUDIO512	<i>Group.</i> Enter the audio group name required.

AUDIO (continued)

Field descriptions (Sheet 2 of 3)

Field	Subfield	Entry	Explanation and action
	FTRINDEX	ACDQ, ACHOLD, ATTQ, CAMPON, CHD, CPARK, CWD, CWO, KSMOH, MBSCAMP, MPHQ, PHOLD, SLQQ, or UCDQ	<p><i>Feature index.</i> Enter a maximum of six features that require a broadcast. See the Functional description section for a description of each feature. If less than six features are required, end the list with a \$.</p> <p>Enter KSMOH for ISDN keysets.</p> <p>The valid feature entries are as follows:</p> <ul style="list-style-type: none"> • ACDQ (Automatic Call Distribution Queue) • ACHOLD (Attendant Hold with Audio) • ATTQ (Attendant Queue) • CAMPON (Attendant Camp-on) • CHD (Call Hold) • CPARK (Call Park) • CWD (Dial Call Waiting) • CWO (Call Waiting Originating) • KSMOH (Key Set Music On Hold - also used by ETSI Call Hold (HOLD)) • MBSCAMP (Meridian Business Set Camp-on) • MPHQ (Multiple Position Hunt with Queue) • PHOLD (Permanent Hold) • SLQQ (Single Line Queue) • UCDQ (Uniform Call Distribution Queue)

AUDIO (continued)**Field descriptions (Sheet 3 of 3)**

Field	Subfield	Entry	Explanation and action
ROUTES		see subfield	Routes. This field consists of up to 6 occurrences of subfield CHOICE and refinements.
	CHOICE	ANN, MUSIC, SILENCE, RINGING, or REPEAT	<p><i>Audio choice.</i> Enter ANN for announcement and datafill refinements AR, CYCLE and ANNCLLI in the next section on this page..</p> <p>Enter MUSIC for continuous music and datafill refinements MUSICLLI and TIME on the next page.</p> <p>Enter REPEAT to repeat a sequence and datafill refinement ROUTE on the next page.</p> <p>Enter RINGING for ringing and datafill refinement TIME on the next page.</p> <p>Enter SILENCE for absence of announcement or music and datafill refinement TIME on the next page.</p>

CHOICE = ANN

If the entry in subfield CHOICE is ANN, enter refinements AR, CYCLES, and ANNCLLI as refinements appear below.

Field descriptions for conditional datafill

Field	Subfield	Entry	Explanation and action
	AR	Y or N	<i>Audible ringing.</i> Enter Y if audible ringing is required before the announcement reaches the beginning of its cycle. If you require silence, enter N.
	CYCLES	1 to 30	<i>Announcement cycles.</i> Enter the number of announcement cycles required.
	ANNCLLI	alphanumeric (1 to 16 characters)	<i>Announcement common language location identifier.</i> Enter the CLLI of the announcement trunk, that must appear in tables ANN and ANNMEMS.

AUDIO (continued)**CHOICE = MUSIC**

If the entry in subfield CHOICE is MUSIC, enter refinements MUSICLLI and TIME as these refinements appear in the following table.

Field descriptions for conditional datafill

Field	Subfield	Entry	Explanation and action
	MUSICLLI	alphanumeric (1 to 16 characters)	<i>Music common language location identifier.</i> Enter the CLLI of the audio trunk, that must appear in table ANN and ANNMEMS.
	TIME	0 to 1800	<i>Time.</i> Enter the delay threshold time, in seconds. An entry of 0 (zero) provides continuous music and is correct as the last entry only.

CHOICE = REPEAT

If the entry in subfield CHOICE is REPEAT, enter refinement ROUTE as this refinement appears in the following table.

Field descriptions for conditional datafill

Field	Subfield	Entry	Explanation and action
	ROUTE	2 to 4	<i>Route.</i> Enter the route number where the repeat sequence begins.

CHOICE = RINGING or SILENCE

If the entry in subfield CHOICE is RINGING or SILENCE, enter refinement TIME as this refinement appears in the following table.

Field descriptions for conditional datafill

Field	Subfield	Entry	Explanation and action
	TIME	0 to 1800	<i>Time.</i> Enter the delay threshold time, in seconds. If the entry in subfield CHOICE is RINGING, enter 0 to provide continued ringing. This entry is correct as a final entry only. If the entry in subfield CHOICE is SILENCE, an entry of 0 provides continued silence and is correct as a final entry only.

Datafill example

Sample datafill for table AUDIO appears in the following example.

AUDIO (end)

This example contains broadcasts defined for audio group AUDIO1 as follows:

- Announcement, ringing, and silence are applied for the Attendant Queue feature (ATTQ).
- Announcement, second announcement, music, and silence are applied for Uniform Call Distribution Queue (UCDQ).

Broadcasts that are defined for audio group AUDIO2 are Announcement, ringing, music, and silence applied for feature Call Hold (CHD).

MAP example for table AUDIO

AUDIOKEY		ROUTES	
AUDIO1	ATTQ	(ANN Y 1 ANN1)	(SILENCE 0)\$
AUDIO1	UCDQ	(ANN N 1 ANN1) (ANN N 1 ANN2)	(MUSIC MUSIC1 6) (SILENCE 0) \$
AUDIO2	CHD	(ANN Y 1 ANN2)	(MUSIC MUSIC1 12) (SILENCE 0) \$
AUDIO1	SLQQ		(SILENCE 0)\$

Table history

EUR006

This release adds the following items to table AUDIO:

- a reference that the ETSI Call Hold feature re-uses FTRINDEX KSMOH in EUR006
- a field description for field ROUTES

CSP02

Added feature SLQ to the list of features in the FTRINDEX subfield, the feature descriptions, and the MAP example in CSP02.

AUTHCODU

Table name

Authcode Database (AUTHCODU) table

Functional description

An in-switch authcode database (AUTHCODU) that contains the authcode numbers and feature parameters for that database. There are five in-switch authcode tables available, for a flexible network. The table names are:

- AUTHCODU
- AUTHCDU2
- AUTHCDU3
- AUTHCDU4
- AUTHCDU5

These tables all have the same field formats.

If there are multiple databases, use table AUTHDIN to determine which database to access for the call. Each database has its own list of authorization numbers and feature parameters running independently of the other databases.

Authcodes are five-, six-, or seven-digit codes identifying the subscriber to bill a call, to screen against unauthorized access to the network, and to indicate classes of service and special features allowed. Calls originating over a DAL, ONAL, ONAT, or EANT (transitional, cut-through) trunk group can be associated with an authcode. Calls can also be screened using PANI or Travel Card screens.

An authcode can be dialed by the subscriber or filed against an originating trunk group, or partially dialed and partially filed.

An authcode is determined for the call in one of these ways:

- All digits dialed by subscriber via DTMF tones.
- All digits filed against the incoming trunk group agency (field VAUTHFLD in table TRKGRP).
- Some digits dialed by the subscriber and prefixed by the digits field against the trunk (partially filed/ partially dialed).

Two fields in the originating trunk group data specify which method is used for all authcode calls on the originating agency. Field AUTHDIAL in the originating trunk group, specifies the number of digits to be dialed by the

AUTHCODU (continued)

subscriber. Field VAUTHFLD contains the digits filed that are prefixed onto the dialed portion of the authcode.

If less than seven digits are filed in the trunk group field VAUTHFLD, the remaining digits must be dialed.

In the case of five-digit authcodes, five digits are datafilled in the authcode tables with two filler digits; such as AA12345, where A is the filler.

For six-digit authcodes, six digits are datafilled in table AUTHCODU with one filler digit. When filing the authcode in trunk group data, no filler digits are filed.

For zero-digit authcodes, meaning that the authcode is completely filed against the trunk in field VAUTHFLD, the fields PINDIGS, PINLEN, and PININDEX are not valid and should be datafilled as follows:

- PINDIGS - \$
- PINLEN - 0
- PININDEX - 0

Each digit of the authcode has a value of 0-9. The leading digit cannot be 0.

Once an authcode is collected from the digit stream, retrieved from the originating trunk group data, or aggregated from partially filed, partially dialed data, it is validated against table AUTHCOD_x, based on ADIN number. If the authcode is not found in the database, it is assumed to be invalid, and the invalid authcode procedure is invoked.

When an authcode has a status of TEMPINVALID, an optional invalid authcode log can be generated in the log system. This log is used to track subscribers using authcodes that are temporarily disallowed for reasons such as malicious or fraudulent use or non-payment of bills.

Table size

The initial size of table AUTHCODU is determined by the expected number of authcodes for each office and set in the Office Engineering parameter V7U_EXPECTED_AUTHS. Notify Northern Telecom (Nortel) of the expected number of authorization codes to be used.

If Office Engineering parameter V7U_EXPECTED_AUTHS is set to zero, no storage is allocated. Otherwise, the minimum table size is 16,000 tuples. The maximum size is determined by the range of possible authcodes, as well as the amount of data store available.

AUTHCODU (continued)**Datafill sequence and implications**

Datafill table CAINGRP with a CAINGRP before datafilling the CAINGRP field in the OPTION vector.

Datafill CDR templates in table CDRTMPLT before datafilling the CDRTMPLT option.

Field descriptions

The following table describes field names, subfield names, and valid data ranges for table AUTHCODU.

(Sheet 1 of 6)

Field	Subfield or refinement	Entry	Explanation and action
AUTHCODE		7 digits (0 to 9, A)	AUTHORIZATION CODE. Enter a 5-, 6-, or 7-digit authorization code. All entries must be 7 characters. Prefix the 5- or 6- digit authorization codes with A. For example, AA43689 is a 5-digit authorization code. Note: An authorization code cannot begin with zero.
STATUS		VALID, PERMINVALID, TEMPINVALID	STATUS. Enter VALID if the authorization code is a valid authcode. Enter TEMPINVALID if authcode is temporarily invalid or unassigned. Enter PERMINVALID if authcode can never be assigned.
ACCTLEN		0 to 12	ACCOUNT CODE LENGTH. Enter the number of digits to collect for the account code. If the subscriber is not required to dial an account code, enter 0.
ACSCRIDX		0 to 4294967295	ACCOUNT CODE SCREENING INDEX. If account code validation is required, specify an index number in table ACSCRN2. This is where the subscriber dialed account code digits are validated. If account code validation is not required, specify the default value of 0. This information is only valid if office parameter VALIDATE_ACCT_AT_DMS250 is Y. If this parameter is N, the account code is validated by way of TCAP to the SCP and table ACSCRN2 is ignored.

AUTHCODU (continued)

(Sheet 2 of 6)

Field	Subfield or refinement	Entry	Explanation and action
OPART		0 to 999	ORIGINATING PARTITION NUMBER. Enter the originating partition number to be associated with the authcode. The OPART and TPART combination maps to a serving translation scheme (STS) for address digits translations by way of table PARTOSTS.
TPART		0 to 31	TERMINATING PARTITION NUMBER. Enter the terminating partition number to be associated with the authcode. Used with the OPART to determine the STS used for the call.
PINDIGS		Up to 4 digits(0 to 9, A to D)	<p>PERSONAL IDENTIFICATION NUMBER DIGITS. PIN digits are an added safety mechanism to further identify authorized users of the system. PINDIGS is an optional field; if PINDIGS is not used, enter \$. This field can be 4 characters in length with a combination of 0-9 and 4th column DTMF digits A-D.</p> <p>Note: A value for the PINDIGS and PININDEX fields cannot exist at the same time. If a value for PINDIGS is entered, then the PININDEX and PINLEN fields must be 0; if a non-zero value PININDEX is entered, then PINDIGS must be \$, and the PINLEN field must not be 0.</p>
MLTCOSID		0 to 2047	MULTIPLE CLASS OF SERVICE (COS) INDEX. This field indexes into table MULTICOS to indirectly point to table COSUS. The default value is 0 to indicate no COS screening is performed. With table MULTICOS, a single MLTCOSID can contain up to 32 COSUS indexes, and therefore COS screening can be performed up to 32 times per call.
HOTLINE		Up to 18 digits(0 to 9)	HOTLINE. If an authcode is associated with a hotline number, enter that number (up to 18 digits). HOTLINE is an option field; if an authcode is not associated with a hotline number, enter a \$.

AUTHCODU (continued)

(Sheet 3 of 6)

Field	Subfield or refinement	Entry	Explanation and action
PVSINDEX		0 to 262140	PRIVATE SPEED INDEX. Enter the speed list number used to identify the private speed list for the authcode. Enter 0, if no speed index is assigned.
SATRES		Y or N	<p>SATELLITE RESTRICTED. Enter Y when calls associated with this authcode are restricted from switching through a satellite. Enter N if calls associated with this authcode are permitted to switch through a satellite. If the authcode is satellite restricted (SATRES=Y) and the terminating trunk group uses a satellite (trunk subgroup parameter SAT), then the current route choice is abandoned and the next route choice is considered for termination.</p> <p>Note: A satellite can be used only once during a call.</p>
FLDONLY		Y or N	AUTHFILED ONLY. Enter Y if authcode can only be used when filed with a trunk group, and cannot be subscriber dialed. If dialed, the call is blocked. Enter N if authcode can be filed by trunk group or dialed by subscriber.
AUTHTRAP		Y or N	AUTHORIZATION TRAP. Enter Y to generate a log report each time an authcode is used. Enter N to disable this feature.
ACCTVAL		Y or N	<p>ACCOUNT CODE VALIDATION. This field determines whether account code validation is required. Validation is performed at the switch by way of table ACSCRN2 or by way of an SCP.</p> <p>Reference office parameter VALIDATE_ACCT_AT_DMS250 (table OFCVAR) to determine where validation occurs. The default value is N.</p>

AUTHCODU (continued)

(Sheet 4 of 6)

Field	Subfield or refinement	Entry	Explanation and action
SPLASHBK		0 to 4	SPLASHBACK. This feature provides the ability to give splashback tone (DTMF) to the Automatic Dialing Machine/Subsequent Address Message (ADM/SAM) subscriber based on the splashback class identifier (0-4) specified in this field. Splashback classes are defined in table SPLASHID. 0 means not a SAM customer. (Splashback Class Identifier 0 is always the value specified when calling party is not an automatic dial machine subscriber.)
TRVALLOW		Y or N	TRAVELING AUTHCODE ALLOWED. This field provides the ability to specify an authcode as a Traveling Authcode. When the originating trunk group, OPART, and the subscriber's authcode do not match, this field determines if the call should proceed or be blocked. Enter Y when the authcode can be used as a traveling authcode and calls are allowed to proceed if the necessary PIN digits are dialed. Enter N if calls should be blocked.
PININDEX		0 to 8191	PERSONAL IDENTIFICATION NUMBER INDEX. Use this field to associate multiple PIN digits with a subscriber's authcode. This value indexes into table MULTIPIN where the dialed PIN digits are validated. Enter a value when multiple PINs are to be associated with the authcode. The index value must be in the range 1-4095 if the PINLEN field is 2. If the PINLEN field is 3, then the index value must be in the range 4096-8191. Enter 0 when the subscriber is not required to dial PIN digits or the PINDIGS field has a PIN digit value. Note: A value for the PINDIGS and PININDEX fields cannot exist at the same time. If a value for PINDIGS is entered, then the PININDEX and PINLEN fields must be 0; if a PININDEX value (non-zero) is entered, then PINDIGS must be \$, and the PINLEN field must not be 0.

AUTHCODU (continued)

(Sheet 5 of 6)

Field	Subfield or refinement	Entry	Explanation and action
PINLEN		0, 2, or 3	PERSONAL IDENTIFICATION NUMBER LENGTH. This field specifies the number of PIN digits to be dialed by the subscriber. Enter a value designated by the length of PIN digits in table MULTIPIN. Enter a 0 when multiple PIN digits are not used.
OPTION			OPTION. This field activates optional features; enter up to three options.
		OPCHOICE	OPCHOICE is only available for 0- or 0+ calls to provide alternate routing for operator service calls. When OPTION=OPCHOICE, datafill the OPCHIDX refinement.
	OPCHIDX	0 to 1023	Enter an index into table OPCHOICE. The default is 0.
		CDRTMPLT	CDR TEMPLATE. Use this option to identify the CDR template used to generate CDRs for the specified authcode. Refer to the OPTION=CDRTMPLT section for refinement datafill.
		CAINGRP	CAIN GROUP. Enter CAINGRP to specify a CAIN subscription group for the authorization code. When OPTION=CAINGRP, datafill the CAINGRP refinement.
	CAINGRP	Valid CAIN group datafilled in table CAINGRP	CAIN GROUP. Enter a valid CAIN group datafilled in table CAINGRP. The authorization code subscribes to CAIN services through the CAIN group.
		CPACTVAL	CPACTVAL. This option dictates that a check is performed to determine if more than the maximum number of allowed calls per authcode use that authcode at the same time for a given node. When OPTION=CPACTVAL, datafill the LIMIT, CALLPS, ACTION, OVERRIDE, and TRMT refinements.

AUTHCODU (continued)

(Sheet 6 of 6)

Field	Subfield or refinement	Entry	Explanation and action
	LIMIT	0 to 255	LIMIT. LIMIT specifies maximum number of calls which can be allowed simultaneously for each authcode. A value of zero indicates that this authcode cannot be used for calls.
	CALLPS	0 to 255	CALLPS. CALLPS allows the user to monitor the current usage of a given authcode. CALLPS must be set to zero when option CPACTVAL is added. If changing option CPACTVAL, the value of this field cannot be changed.
	ACTION	TRMT	ACTION.
	OVERRIDE	N	OVERRIDE. Enter N to specify that no capability to override a previously set treatment is supported.
	TRMT	MAUC	TREATMENT.

OPTION=CDRTMPLT

When OPTION=CDRTMPLT, datafill the TMPLTIDX and USEEDIT refinements.

Refinement	Subfield or refinement	Entry	Explanation and action
TMPLTIDX		Valid name datafilled in table CDRTMPLT	TEMPLATE INDEX. When SOC option UBFR0001 is enabled, you can use table CDRTMPLT to create new CDR template. For more information on CDR templates, see <i>UCS DMS-250 Billing Records Application Guide</i> .
USEEDIT		N or Y	USE EDIT. Enter N to use the active version of the CDR template. Y indicates that the edit version is used. Note: This field is used for testing purposes only. It should be set to N, which is the default.

AUTHCODU (end)

Datafill example

The following example shows datafill for table AUTHCODU.

```
AUTHCODE STATUS ACCTLEN ACSCRIDX OPART TPART PINDIGS MLTCOSID
PVSINDEX SATRES FLDONLY AUTHTRAP ACCTVAL SPLASHBK TRVALLOW PIN
OPTIONS
```

```
1234567 VALID 0 0 7 31 $ 0 $ 0 Y Y Y Y 0 Y 0 0 (OPCHOICE 1) $
5112271 VALID 0 0 111 0 $ 0 $ 51 N N N N 0 Y 0 0 (CPACTVAL 1 0
```

Table history**UCS13**

Removed UCS07 and UCS07FLEX values from table OPTION=CDRTMPLT (A60007776).

UCS11

The OPCHIDX field is updated. The maximum number of entries is expanded to 1023. (A60006449).

UCS08

Added option CPACTVAL.

UCS06

Updated to support the following enhancements:

- new MULTICOS table
- expansion of speed list indexes
- Billing Records (flexible CDR)

AUTHCDU2

Table name

Authcode Database 2 (AUTHCDU2) table

Functional description

AUTHCDU2 table contains authcodes. Each office determines the initial size of table AUTHCDU2 by the expected number of authcodes.

Table size

If Office Engineering parameter V7U_EXPECTED_AUTHS is set to 0, no storage is allocated. Otherwise, the minimum table size is 16,000 tuples. The maximum size is determined by the range of possible authcodes and the amount of data store available.

Set the office parameter to reflect the actual number of expected authcodes.

Datafill sequence and implications

Datafill table CAINGRP with a CAINGRP before datafilling the CAINGRP field in the OPTION vector.

Datafill CDR templates in table CDRTMPLT before datafilling the CDRTMPLT option.

AUTHCDU2 (continued)**Field descriptions**

The following table describes field names, subfield names, and valid data ranges for table AUTHCDU2.

(Sheet 1 of 6)

Field	Subfield or refinement	Entry	Explanation and action
AUTHCODE		7 digits(0 to 9, A)	AUTHORIZATION CODE. Enter a 5-, 6-, or 7-digit authorization code. All entries must be 7 characters. Prefix the 5- or 6- digit authorization codes with A. For example, AA43689 is a 5-digit authorization code. Note: An authorization code cannot begin with zero.
STATUS		VALID, TEMPINVALID, PERMINVALID	STATUS. Enter VALID if the authorization code is a valid authcode. Enter TEMPINVALID if authcode is temporarily invalid or unassigned. Enter PERMINVALID if authcode can never be assigned.
ACCTLEN		0 to 12	ACCOUNT CODE LENGTH. Enter the number of digits to collect for the account code. If the subscriber is not required to dial an account code, enter 0.
ACSCRIDX		0 to 4294967295	ACCOUNT CODE SCREENING INDEX. If account code validation is required, specify an index number in table ACSCRN2. This is where the subscriber dialed account code digits are validated. If account code validation is not required, specify the default value of 0. This information is only valid if office parameter VALIDATE_ACCT_AT_DMS250 is Y. If this parameter is N, the account code is validated by way of TCAP to the SCP and table ACSCRN2 is ignored.
OPART		0 to 999	ORIGINATING PARTITION NUMBER. Enter the originating partition number to be associated with the authcode. The OPART and TPART combination maps to a serving translation scheme (STS) for address digits translations by way of table PARTOSTS.

AUTHCDU2 (continued)

(Sheet 2 of 6)

Field	Subfield or refinement	Entry	Explanation and action
TPART		0 to 31	TERMINATING PARTITION NUMBER. Enter the terminating partition number to be associated with the authcode. Used with the OPART to determine the STS used for the call.
PINDIGS		Up to 4 digits (0 to 9, A to D)	PERSONAL IDENTIFICATION NUMBER DIGITS. PIN digits are an added safety mechanism to further identify authorized users of the system. This field can be 4 characters in length with a combination of 0-9 and 4th column DTMF digits A-D. PINDIGS is an optional field; if PINDIGS is not used, enter \$.
MLTCOSID		0 to 2047	MULTIPLE CLASS OF SERVICE (COS) INDEX. This field indexes into table MULTICOS to indirectly point to table COSUS. The default value is 0 to indicate no COS screening is performed. With table MULTICOS, a single MLTCOSID can contain up to 32 COSUS indexes, and therefore COS screening can be performed up to 32 times per call.
HOTLINE		Up to 18 digits(0 to 9)	HOTLINE. If an authcode is associated with a hotline number, enter that number (up to 18 digits). HOTLINE is an option field; if an authcode is not associated with a hotline number, enter a \$.
PVSINDEX		0 to 262140	PRIVATE SPEED INDEX. Enter the speed list number used to identify the private speed list for the authcode. Enter 0, if no speed index is assigned.

AUTHCDU2 (continued)

(Sheet 3 of 6)

Field	Subfield or refinement	Entry	Explanation and action
SATRES		Y or N	<p>SATELLITE RESTRICTED. Enter Y when calls associated with this authcode are restricted from switching through a satellite. Enter N if calls associated with this authcode are permitted to switch through a satellite. If the authcode is satellite restricted (SATRES=Y) and the terminating trunk group uses a satellite (trunk subgroup parameter SAT), then the current route choice is abandoned and the next route choice is considered for termination.</p> <p>Note: A satellite can be used only once during a call.</p>
FLDONLY		Y or N	<p>AUTHFILED ONLY. Enter Y if authcode can only be used when filed with a trunk group, and cannot be subscriber dialed. If dialed, the call is blocked. Enter N if authcode can be filed by trunk group or dialed by subscriber.</p>
AUTHTRAP		Y or N	<p>AUTHORIZATION TRAP. Enter Y to generate a log report each time an authcode is used. Enter N to disable this feature.</p>
ACCTVAL		Y or N	<p>ACCOUNT CODE VALIDATION. This field determines whether account code validation is required. Validation is performed at the switch by way of table ACSCRN2 or an SCP.</p> <p>Reference office parameter VALIDATE_ACCT_AT_DMS250 (table OFCVAR) to determine where validation occurs. The default value is N.</p>
SPLASHBK		0 to 4	<p>SPLASHBACK. This feature provides the ability to give splashback tone (DTMF) to the Automatic Dialing Machine/Subsequent Address Message (ADM/SAM) subscriber based on the splashback class identifier (0-4) specified in this field. Splashback classes are defined in table SPLASHID. 0 means not a SAM customer. (Splashback Class Identifier 0 is always the value specified when calling party is not an automatic dial machine subscriber.)</p>

AUTHCDU2 (continued)

(Sheet 4 of 6)

Field	Subfield or refinement	Entry	Explanation and action
TRVALLOW		Y or N	TRAVELING AUTHCODE ALLOWED. This field provides the ability to specify an authcode as a traveling authcode. When the originating trunk group, OPART, and the subscriber's authcode do not match, this field determines if the call should proceed or be blocked. Enter Y when the authcode can be used as a traveling authcode and calls are allowed to proceed if the necessary PIN digits are dialed. Enter N if calls should be blocked.
PININDEX		0 to 8191	PERSONAL IDENTIFICATION NUMBER INDEX. Use this field to associate multiple PIN digits with a subscriber's authcode. This value indexes into table MULTIPIN where the dialed PIN digits are validated. Enter a value when multiple PINs are to be associated with the authcode. The index value must be in the range 1-4095 if the PINLEN field is 2. If the PINLEN field is 3, then the index value must be in the range 4096-8191. Enter 0 when the subscriber is not required to dial PIN digits or the PINDIGS field has a PIN digit value. Note: A value for the PINDIGS and PININDEX fields cannot exist at the same time. If a value for PINDIGS is entered, then the PININDEX and PINLEN fields must be 0; if a PININDEX value (non-zero) is entered, then PINDIGS must be \$, and the PINLEN field must not be 0.
PINLEN		0, 2, or 3	PERSONAL IDENTIFICATION NUMBER LENGTH. This field specifies the number of PIN digits to be dialed by the subscriber. Enter a value designated by the length of PIN digits in table MULTIPIN. Enter a 0 when multiple PIN digits are not used.
OPTION			OPTION. This field activates optional features; enter up to 2 options.

AUTHCDU2 (continued)

(Sheet 5 of 6)

Field	Subfield or refinement	Entry	Explanation and action
		OPCHOICE	OPCHOICE is only available for 0- or 0+ calls to provide alternate routing for operator service calls. When OPTION=OPCHOICE, datafill the OPCHIDX refinement.
	OPCHIDX	0 to 1023	Enter an index into table OPCHOICE. The default is 0.
		CAINGRP	CAIN GROUP. Enter CAINGRP to specify a CAIN subscription group for the authorization code. When OPTION=CAINGRP, datafill the CAINGRP refinement.
	CAINGRP	Valid CAIN group datafilled in table CAINGRP	CAIN GROUP. Enter a valid CAIN group datafilled in table CAINGRP. The authorization code subscribes to CAIN services through the CAIN group.
		CDRTMPLT	CDR TEMPLATE. Use this option to identify the CDR template used to generate CDRs for the specified authcode. Refer to the OPTION=CDRTMPLT section for refinement datafill.
		CPACTVAL	CPACTVAL. This option dictates that a check is performed to determine if more than the maximum number of allowed calls per authcode use that authcode at the same time for a given node. When OPTION=CPACTVAL, datafill the LIMIT, CALLPS, ACTION, OVERRIDE, and TRMT refinements.
	LIMIT	0 to 255	LIMIT. LIMIT specifies maximum number of calls which can be allowed simultaneously for each authcode. A value of zero indicates that this authcode cannot be used for calls.
	CALLPS	0 to 255	CALLPS. CALLPS allows the user to monitor the current usage of a given authcode. CALLPS must be set to zero when option CPACTVAL is added. If changing option CPACTVAL, the value of this field cannot be changed.
	ACTION	TRMT	ACTION.

AUTHCDU2 (continued)

(Sheet 6 of 6)

Field	Subfield or refinement	Entry	Explanation and action
	OVERRIDE	N	OVERRIDE. Enter N to specify that no capability to override a previously set treatment is supported.
	TRMT	MAUC	TREATMENT.

OPTION=CDRTMPLT

When OPTION=CDRTMPLT, datafill the TMPLTIDX and USEEDIT refinements.

Refinement	Subfield or refinement	Entry	Explanation and action
TMPLTIDX		Valid name datafilled in table CDRTMPLT	TEMPLATE INDEX. When SOC option UBFR0001 is enabled, you can use table CDRTMPLT to create new CDR template. For more information on CDR templates, see <i>UCS DMS-250 Billing Records Application Guide</i> .
USEEDIT		N or Y	USE EDIT. Enter N to use the active version of the CDR template. Y indicates that the edit version is used. Note: This field is used for testing purposes only. It should be set to N, which is the default.

Datafill example

The following example shows datafill for table AUTHCDU2.

```
AUTHCODE STATUS ACCTLEN ACSCRIDX OPART TPART PINDIGS MLTCOSID
PVSINDEX SATRES FLDONLY AUTHTRAP ACCTVAL SPLASHBK TRVALLOW PI
OPTIONS
```

```
2147612 VALID 0 0 261 0 $ 0 $ 0 N N N N 0 Y 8000 3 $
5112271 VALID 0 0 111 0 $ 0 $ 51 N N N N 0 Y 0 0 (CPACTVAL 1
```

Table history**UCS13**

Removed UCS07 and UCS07FLEX values from table OPTION=CDRTMPLT (A60007776).

UCS11

The OPCHIDX field is updated. The maximum number of entries is expanded to 1023. (A60006449).

UCS08

Added option CPACTVAL.

UCS06

Updated to support the following enhancements:

- new MULTICOS table
- expansion of speed list indexes
- Billing Records (flexible CDR)

AUTHCDU3

Table name

Authcode Database 3 (AUTHCDU3) table

Functional description

The Authcode Database 3 (AUTHCDU3) contains authcodes. Each office determines the initial size of table AUTHCDU3 by the expected number of authcodes.

Table size

If Office Engineering parameter V7U_EXPECTED_AUTHS is set to 0, no storage is allocated. Otherwise, the minimum table size is 16,000 tuples. The maximum size is determined by the range of possible authcodes and the amount of data store available.

Set the office parameter to reflect the actual number of expected authcodes.

Datafill sequence and implications

Datafill table CAINGRP with a CAINGRP before datafilling the CAINGRP field in the OPTION vector.

Datafill CDR templates in table CDRTMPLT before datafilling the CDRTMPLT option.

AUTHCDU3 (continued)**Field descriptions**

The following table describes field names, subfield names, and valid data ranges for table AUTHCDU3.

(Sheet 1 of 6)

Field	Subfield or refinement	Entry	Explanation and action
AUTHCODE		7 digits(0 to 9, A)	AUTHORIZATION CODE. Enter a 5-, 6-, or 7-digit authorization code. All entries must be 7 characters. Prefix the 5- or 6- digit authorization codes with A. For example, AA43689 is a 5-digit authorization code. Note: An authorization code cannot begin with zero.
STATUS		VALID, TEMPINVALID, PERMINVALID	STATUS. Enter VALID if the authorization code is a valid authcode. Enter TEMPINVALID if authcode is temporarily invalid or unassigned. Enter PERMINVALID if authcode can never be assigned.
ACCTLEN		0 to12	ACCOUNT CODE LENGTH. Enter the number of digits to collect for the account code. If the subscriber is not required to dial an account code, enter 0.
ACSCRIDX		0 to 4294967295	ACCOUNT CODE SCREENING INDEX. If account code validation is required, specify an index number in table ACSCRN2. This is where the subscriber dialed account code digits are validated. If account code validation is not required, specify the default value of 0. This information is only valid if office parameter VALIDATE_ACCT_AT_DMS250 is Y. If this parmameter is N, the account code is validated by way of TCAP to the SCP and table ACSCRN2 is ignored.
OPART		0 to 999	ORIGINATING PARTITION NUMBER. Enter the originating partition number to be associated with the authcode. The OPART and TPART combination maps to a serving translation scheme (STS) for address digits translations by way of table PARTOSTS.

AUTHCDU3 (continued)

(Sheet 2 of 6)

Field	Subfield or refinement	Entry	Explanation and action
TPART		0 to 31	TERMINATING PARTITION NUMBER. Enter the terminating partition number to be associated with the authcode. Used with the OPART to determine the STS used for the call.
PINDIGS		Up to 4 digits (0 to 9, A to D)	PERSONAL IDENTIFICATION NUMBER DIGITS. PIN digits are an added safety mechanism to further identify authorized users of the system. This field can be 4 characters in length with a combination of 0-9 and 4th column DTMF digits A-D. PINDIGS is an optional field; if PINDIGS is not used, enter \$.
MLTCOSID		0 to 2047	MULTIPLE CLASS OF SERVICE (COS) INDEX. This field indexes into table MULTICOS to indirectly point to table COSUS. The default value is 0 to indicate no COS screening is performed. With table MULTICOS, a single MLTCOSID can contain up to 32 COSUS indexes, and therefore COS screening can be performed up to 32 times per call.
HOTLINE		Up to 18 digits(0 to 9)	HOTLINE. If an authcode is associated with a hotline number, enter that number (up to 18 digits). HOTLINE is an option field; if an authcode is not associated with a hotline number, enter a \$.
PVSINDEX		0 to 262140	PRIVATE SPEED INDEX. Enter the speed list number used to identify the private speed list for the authcode. Enter 0, if no speed index is assigned.

AUTHCDU3 (continued)

(Sheet 3 of 6)

Field	Subfield or refinement	Entry	Explanation and action
SATRES		Y or N	<p>SATELLITE RESTRICTED. Enter Y when calls associated with this authcode are restricted from switching through a satellite. Enter N if calls associated with this authcode are permitted to switch through a satellite. If the authcode is satellite restricted (SATRES=Y) and the terminating trunk group uses a satellite (trunk subgroup parameter SAT), then the current route choice is abandoned and the next route choice is considered for termination.</p> <p>Note: A satellite can be used only once during a call.</p>
FLDONLY		Y or N	<p>AUTHFILED ONLY. Enter Y if authcode can only be used when filed with a trunk group, and cannot be subscriber dialed. If dialed, the call is blocked. Enter N if authcode can be filed by trunk group or dialed by subscriber.</p>
AUTHTRAP		Y or N	<p>AUTHORIZATION TRAP. Enter Y to generate a log report each time an authcode is used. Enter N to disable this feature.</p>
ACCTVAL		Y or N	<p>ACCOUNT CODE VALIDATION. This field determines whether account code validation is required. Validation is performed at the switch via table ACSCRN2 or via an SCP.</p> <p>Reference office parameter VALIDATE_ACCT_AT_DMS250 (table OFCVAR) to determine where validation occurs. The default value is N.</p>
SPLASHBK		0 to 4	<p>SPLASHBACK. This feature provides the ability to give splashback tone (DTMF) to the Automatic Dialing Machine/Subsequent Address Message (ADM/SAM) subscriber based on the splashback class identifier (0-4) specified in this field. Splashback classes are defined in table SPLASHID. 0 means not a SAM customer. (Splashback Class Identifier 0 is always the value specified when calling party is not an automatic dial machine subscriber.)</p>

AUTHCDU3 (continued)

(Sheet 4 of 6)

Field	Subfield or refinement	Entry	Explanation and action
TRVALLOW		Y or N	TRAVELING AUTHCODE ALLOWED. This field provides the ability to specify an authcode as a traveling authcode. When the originating trunk group, OPART, and the subscriber's authcode do not match, this field determines if the call should proceed or be blocked. Enter Y when the authcode can be used as a traveling authcode and calls are allowed to proceed if the necessary PIN digits are dialed. Enter N if calls should be blocked.
PININDEX		0 to 8191	PERSONAL IDENTIFICATION NUMBER INDEX. Use this field to associate multiple PIN digits with a subscriber's authcode. This value indexes into table MULTIPIN where the dialed PIN digits are validated. Enter a value when multiple PINs are to be associated with the authcode. The index value must be in the range 1-4095 if the PINLEN field is 2. If the PINLEN field is 3, then the index value must be in the range 4096-8191. Enter 0 when the subscriber is not required to dial PIN digits or the PINDIGS field has a PIN digit value. Note: A value for the PINDIGS and PININDEX fields cannot exist at the same time. If a value for PINDIGS is entered, then the PININDEX and PINLEN fields must be 0; if a PININDEX value (non-zero) is entered, then PINDIGS must be \$, and the PINLEN field must not be 0.
PINLEN		0, 2, or 3	PERSONAL IDENTIFICATION NUMBER LENGTH. This field specifies the number of PIN digits to be dialed by the subscriber. Enter a value designated by the length of PIN digits in table MULTIPIN. Enter a 0 when multiple PIN digits are not used.
OPTION			OPTION. This field activates optional features; enter up to 2 options.

AUTHCDU3 (continued)

(Sheet 5 of 6)

Field	Subfield or refinement	Entry	Explanation and action
		OPCHOICE	OPCHOICE is only available for 0- or 0+ calls to provide alternate routing for operator service calls. When OPTION=OPCHOICE, datafill the OPCHIDX refinement.
	OPCHIDX	0 to 1023	Enter an index into table OPCHOICE. The default is 0.
		CAINGRP	CAIN GROUP. Enter CAINGRP to specify a CAIN subscription group for the authorization code. When OPTION=CAINGRP, datafill the CAINGRP refinement.
	CAINGRP	Valid CAIN group datafilled in table CAINGRP	CAIN GROUP. Enter a valid CAIN group datafilled in table CAINGRP. The authorization code subscribes to CAIN services through the CAIN group.
		CDRTMPLT	CDR TEMPLATE. Use this option to identify the CDR template used to generate CDRs for the specified authcode. Refer to the OPTION=CDRTMPLT section for refinement datafill.
		CPACTVAL	CPACTVAL. This option dictates that a check is performed to determine if more than the maximum number of allowed calls per authcode use that authcode at the same time for a given node. When OPTION=CPACTVAL, datafill the LIMIT, CALLPS, ACTION, OVERRIDE, and TRMT refinements.
	LIMIT	0 to 255	LIMIT. LIMIT specifies maximum number of calls which can be allowed simultaneously for each authcode. A value of zero indicates that this authcode cannot be used for calls.
	CALLPS	0 to 255	CALLPS. CALLPS allows the user to monitor the current usage of a given authcode. CALLPS must be set to zero when option CPACTVAL is added. If changing option CPACTVAL, the value of this field cannot be changed.
	ACTION	TRMT	ACTION.

AUTHCDU3 (continued)

(Sheet 6 of 6)

Field	Subfield or refinement	Entry	Explanation and action
	OVERRIDE	N	OVERRIDE. Enter N to specify that no capability to override a previously set treatment is supported.
	TRMT	MAUC	TREATMENT.

OPTION=CDRTMPLT

When OPTION=CDRTMPLT, datafill the TMPLTIDX and USEEDIT refinements.

Refinement	Subfield or refinement	Entry	Explanation and action
TMPLTIDX		Valid name datafilled in table CDRTMPLT	TEMPLATE INDEX. When SOC option UBFR0001 is enabled, you can use table CDRTMPLT to create new CDR template. For more information on CDR templates, see <i>UCS DMS-250 Billing Records Application Guide</i> .
USEEDIT		N or Y	USE EDIT. Enter N to use the active version of the CDR template. Y indicates that the edit version is used. Note: This field is used for testing purposes only. It should be set to N, which is the default.

Datafill example

The following example shows datafill for table AUTHCDU3.

```
AUTHCODE STATUS ACCTLEN ACSCRIDX OPART TPART PINDIGS MLTCOSID
PVSINDEX SATRES FLDONLY AUTHTRAP ACCTVAL SPLASHBK TRVALLOW PII
OPTIONS
```

```
4722211 VALID 0 0 972 0 $ 0 $ 51 N N N N 0 Y 0 0 $
5112271 VALID 0 0 111 0 $ 0 $ 51 N N N N 0 Y 0 0 (CPACTVAL 1 (
```

Table history**UCS13**

Removed UCS07 and UCS07FLEX values from table OPTION=CDRTMPLT (A60007776).

UCS11

The OPCHIDX field is updated. The maximum number of entries is expanded to 1023. (A60006449).

UCS08

Added option CPACTVAL.

UCS06

Updated to support the following enhancements:

- new MULTICOS table
- expansion of speed list indexes
- Billing Records (flexible CDR)

AUTHCDU4

Table name

Authcode Database 4 (AUTHCDU4) table

Functional description

AUTHCDU4 table contains authcodes. Each office determines the initial size of table AUTHCDU4 by the expected number of authcodes.

Table size

If Office Engineering parameter V7U_EXPECTED_AUTHS is set to 0, no storage is allocated. Otherwise, the minimum table size is 16,000 tuples. The maximum size is determined by the range of possible authcodes and the amount of data store available.

Set the office parameter to reflect the actual number of expected authcodes.

Datafill sequence and implications

Datafill table CAINGRP with a CAINGRP before datafilling the CAINGRP field in the OPTION vector.

Datafill CDR templates in table CDRTMPLT before datafilling the CDRTMPLT option.

AUTHCDU4 (continued)**Field descriptions**

The following table describes field names, subfield names, and valid data ranges for table AUTHCDU4.

(Sheet 1 of 6)

Field	Subfield or refinement	Entry	Explanation and action
AUTHCODE		7 digits(0 to 9, A)	AUTHORIZATION CODE. Enter a 5-, 6-, or 7-digit authorization code. All entries must be 7 characters. Prefix the 5- or 6- digit authorization codes with A. For example, AA43689 is a 5-digit authorization code. Note: An authorization code cannot begin with zero.
STATUS		VALID, TEMPINVALID, PERMINVALID	STATUS. Enter VALID if the authorization code is a valid authcode. Enter TEMPINVALID if authcode is temporarily invalid or unassigned. Enter PERMINVALID if authcode can never be assigned.
ACCTLEN		0 to 12	ACCOUNT CODE LENGTH. Enter the number of digits to collect for the account code. If the subscriber is not required to dial an account code, enter 0.
ACSCRIDX		0 to 4294967295	ACCOUNT CODE SCREENING INDEX. If account code validation is required, specify an index number in table ACSCRN2. This is where the subscriber dialed account code digits are validated. If account code validation is not required, specify the default value of 0. This information is only valid if office parameter VALIDATE_ACCT_AT_DMS250 is Y. If this parmameter is N, the account code is validated by way of TCAP to the SCP and table ACSCRN2 is ignored.
OPART		0 to 999	ORIGINATING PARTITION NUMBER. Enter the originating partition number to be associated with the authcode. The OPART and TPART combination maps to a serving translation scheme (STS) for address digits translations by way of table PARTOSTS.

AUTHCDU4 (continued)

(Sheet 2 of 6)

Field	Subfield or refinement	Entry	Explanation and action
TPART		0 to 31	TERMINATING PARTITION NUMBER. Enter the terminating partition number to be associated with the authcode. Used with the OPART to determine the STS used for the call.
PINDIGS		Up to 4 digits (0 to 9, A to D)	PERSONAL IDENTIFICATION NUMBER DIGITS. PIN digits are an added safety mechanism to further identify authorized users of the system. This field can be 4 characters in length with a combination of 0-9 and 4th column DTMF digits A-D. PINDIGS is an optional field; if PINDIGS is not used, enter \$.
MLTCOSID		0 to 2047	MULTIPLE CLASS OF SERVICE (COS) INDEX. This field indexes into table MULTICOS to indirectly point to table COSUS. The default value is 0 to indicate no COS screening is performed. With table MULTICOS, a single MLTCOSID can contain up to 32 COSUS indexes, and therefore COS screening can be performed up to 32 times per call.
HOTLINE		Up to 18 digits(0 to 9)	HOTLINE. If an authcode is associated with a hotline number, enter that number (up to 18 digits). HOTLINE is an option field; if an authcode is not associated with a hotline number, enter a \$.
PVSINDEX		0 to 262140	PRIVATE SPEED INDEX. Enter the speed list number used to identify the private speed list for the authcode. Enter 0, if no speed index is assigned.

AUTHCDU4 (continued)

(Sheet 3 of 6)

Field	Subfield or refinement	Entry	Explanation and action
SATRES		Y or N	<p>SATELLITE RESTRICTED. Enter Y when calls associated with this authcode are restricted from switching through a satellite. Enter N if calls associated with this authcode are permitted to switch through a satellite. If the authcode is satellite restricted (SATRES=Y) and the terminating trunk group uses a satellite (trunk subgroup parameter SAT), then the current route choice is abandoned and the next route choice is considered for termination.</p> <p>Note: A satellite can be used only once during a call.</p>
FLDONLY		Y or N	<p>AUTHFILED ONLY. Enter Y if authcode can only be used when filed with a trunk group, and cannot be subscriber dialed. If dialed, the call is blocked. Enter N if authcode can be filed by trunk group or dialed by subscriber.</p>
AUTHTRAP		Y or N	<p>AUTHORIZATION TRAP. Enter Y to generate a log report each time an authcode is used. Enter N to disable this feature.</p>
ACCTVAL		Y or N	<p>ACCOUNT CODE VALIDATION. This field determines whether account code validation is required. Validation is performed at the switch by way of table ACSCRN2 or an SCP.</p> <p>Reference office parameter VALIDATE_ACCT_AT_DMS250 (table OFCVAR) to determine where validation occurs. The default value is N.</p>

AUTHCDU4 (continued)

(Sheet 4 of 6)

Field	Subfield or refinement	Entry	Explanation and action
SPLASHBK		0 to 4	SPLASHBACK. This feature provides the ability to give splashback tone (DTMF) to the Automatic Dialing Machine/Subsequent Address Message (ADM/SAM) subscriber based on the splashback class identifier (0-4) specified in this field. Splashback classes are defined in table SPLASHID. 0 means not a SAM customer. (Splashback Class Identifier 0 is always the value specified when calling party is not an automatic dial machine subscriber.)
TRVALLOW		Y or N	TRAVELING AUTHCODE ALLOWED. This field provides the ability to specify an authcode as a traveling authcode. When the originating trunk group, OPART, and the subscriber's authcode do not match, this field determines if the call should proceed or be blocked. Enter Y when the authcode can be used as a traveling authcode and calls are allowed to proceed if the necessary PIN digits are dialed. Enter N if calls should be blocked.
PININDEX		0 to 8191	PERSONAL IDENTIFICATION NUMBER INDEX. Use this field to associate multiple PIN digits with a subscriber's authcode. This value indexes into table MULTIPIN where the dialed PIN digits are validated. Enter a value when multiple PINs are to be associated with the authcode. The index value must be in the range 1-4095 if the PINLEN field is 2. If the PINLEN field is 3, then the index value must be in the range 4096-8191. Enter 0 when the subscriber is not required to dial PIN digits or the PINDIGS field has a PIN digit value. Note: A value for the PINDIGS and PININDEX fields cannot exist at the same time. If a value for PINDIGS is entered, then the PININDEX and PINLEN fields must be 0; if a PININDEX value (non-zero) is entered, then PINDIGS must be \$, and the PINLEN field must not be 0.

AUTHCDU4 (continued)

(Sheet 5 of 6)

Field	Subfield or refinement	Entry	Explanation and action
PINLEN		0, 2, or 3	PERSONAL IDENTIFICATION NUMBER LENGTH. This field specifies the number of PIN digits to be dialed by the subscriber. Enter a value designated by the length of PIN digits in table MULTIPIN. Enter a 0 when multiple PIN digits are not used.
OPTION			OPTION. This field activates optional features; enter up to 2 options.
		OPCHOICE	OPCHOICE is only available for 0- or 0+ calls to provide alternate routing for operator service calls. When OPTION=OPCHOICE, datafill the OPCHIDX refinement.
	OPCHIDX	0 to 1023	Enter an index into table OPCHOICE. The default is 0.
		CAINGRP	CAIN GROUP. Enter CAINGRP to specify a CAIN subscription group for the authorization code. When OPTION=CAINGRP, datafill the CAINGRP refinement.
	CAINGRP	Valid CAIN group datafilled in table CAINGRP	CAIN GROUP. Enter a valid CAIN group datafilled in table CAINGRP. The authorization code subscribes to CAIN services through the CAIN group.
		CDRTMPLT	CDR TEMPLATE. Use this option to identify the CDR template used to generate CDRs for the specified authcode. Refer to the OPTION=CDRTMPLT section for refinement datafill.
		CPACTVAL	CPACTVAL. This option dictates that a check is performed to determine if more than the maximum number of allowed calls per authcode use that authcode at the same time for a given node. When OPTION=CPACTVAL, datafill the LIMIT, CALLPS, ACTION, OVERRIDE, and TRMT refinements.

AUTHCDU4 (continued)

(Sheet 6 of 6)

Field	Subfield or refinement	Entry	Explanation and action
	LIMIT	0 to 255	LIMIT. LIMIT specifies maximum number of calls which can be allowed simultaneously for each authcode. A value of zero indicates that this authcode cannot be used for calls.
	CALLPS	0 to 255	CALLPS. CALLPS allows the user to monitor the current usage of a given authcode. CALLPS must be set to zero when option CPACTVAL is added. If changing option CPACTVAL, the value of this field cannot be changed.
	ACTION	TRMT	ACTION.
	OVERRIDE	N	OVERRIDE. Enter N to specify that no capability to override a previously set treatment is supported.
	TRMT	MAUC	TREATMENT.

OPTION=CDRTMPLT

When OPTION=CDRTMPLT, datafill the TMPLTIDX and USEEDIT refinements.

Refinement	Subfield or refinement	Entry	Explanation and action
TMPLTIDX		Valid name datafilled in table CDRTMPLT	TEMPLATE INDEX. When SOC option UBFR0001 is enabled, you can use table CDRTMPLT to create new CDR template. For more information on CDR templates, see <i>UCS DMS-250 Billing Records Application Guide</i> .
USEEDIT		N or Y	USE EDIT. Enter N to use the active version of the CDR template. Y indicates that the edit version is used. Note: This field is used for testing purposes only. It should be set to N, which is the default.

AUTHCDU4 (end)**Datafill example**

The following example shows datafill for table AUTHCDU4.

```
AUTHCODE STATUS ACCTLEN ACSCRIDX OPART TPART PINDIGS MLTCOSID
PVSINDEX SATRES FLDONLY AUTHTRAP ACCTVAL SPLASHBK TRVALLOW PIN
OPTIONS
```

```
4742211 VALID 0 0 974 0 $ 0 $ 51 N N N N 0 Y 0 0 $
5112271 VALID 0 0 111 0 $ 0 $ 51 N N N N 0 Y 0 0 (CPACTVAL 1 0
```

Table history**UCS13**

Removed UCS07 and UCS07FLEX values from table OPTION=CDRTMPLT (A60007776).

UCS11

The OPCHIDX field is updated. The maximum number of entries is expanded to 1023. (A60006449).

UCS08

Added option CPACTVAL.

UCS06

Updated to support the following enhancements:

- new MULTICOS table
- expansion of speed list indexes
- Billing Records (flexible CDR)

AUTHCDU5

Table name

Authcode Database 5 (AUTHCDU5) table

Functional description

AUTHCDU5 table contains authcodes. Each office determines the initial size of table AUTHCDU5 by the expected number of authcodes.

Table size

If Office Engineering parameter V7U_EXPECTED_AUTHS is set to 0, no storage is allocated. Otherwise, the minimum table size is 16,000 tuples. The maximum size is determined by the range of possible authcodes and the amount of data store available.

Set the office parameter to reflect the actual number of expected authcodes.

Datafill sequence and implications

Datafill table CAINGRP with a CAINGRP before datafilling the CAINGRP field in the OPTION vector.

Datafill CDR templates in table CDRTMPLT before datafilling the CDRTMPLT option.

AUTHCDU5 (continued)**Field descriptions**

The following table describes field names, subfield names, and valid data ranges for table AUTHCDU5.

(Sheet 1 of 5)

Field	Subfield or refinement	Entry	Explanation and action
AUTHCODE		7 digits(0 to 9, A)	AUTHORIZATION CODE. Enter a 5-, 6-, or 7-digit authorization code. All entries must be 7 characters. Prefix the 5- or 6- digit authorization codes with A. For example, AA43689 is a 5-digit authorization code. Note: An authorization code cannot begin with zero.
STATUS		VALID, TEMPINVALID, PERMINVALID	STATUS. Enter VALID if the authorization code is a valid authcode. Enter TEMPINVALID if authcode is temporarily invalid or unassigned. Enter PERMINVALID if authcode can never be assigned.
ACCTLEN		0 to 12	ACCOUNT CODE LENGTH. Enter the number of digits to collect for the account code. If the subscriber is not required to dial an account code, enter 0.
ACSCRIDX		0 to 4294967295	ACCOUNT CODE SCREENING INDEX. If account code validation is required, specify an index number in table ACSCRN2. This is where the subscriber dialed account code digits are validated. If account code validation is not required, specify the default value of 0. This information is only valid if office parameter VALIDATE_ACCT_AT_DMS250 is Y. If this parmameter is N, the account code is validated by way of TCAP to the SCP and table ACSCRN2 is ignored.
OPART		0 to 999	ORIGINATING PARTITION NUMBER. Enter the originating partition number to be associated with the authcode. The OPART and TPART combination maps to a serving translation scheme (STS) for address digits translations by way of table PARTOSTS.

AUTHCDU5 (continued)

(Sheet 2 of 5)

Field	Subfield or refinement	Entry	Explanation and action
TPART		0 to 31	TERMINATING PARTITION NUMBER. Enter the terminating partition number to be associated with the authcode. Used with the OPART to determine the STS used for the call.
PINDIGS		Up to 4 digits (0 to 9, A to D)	PERSONAL IDENTIFICATION NUMBER DIGITS. PIN digits are an added safety mechanism to further identify authorized users of the system. This field can be 4 characters in length with a combination of 0-9 and 4th column DTMF digits A-D. PINDIGS is an optional field; if PINDIGS is not used, enter \$.
MLTCOSID		0 to 2047	MULTIPLE CLASS OF SERVICE (COS) INDEX. This field indexes into table MULTICOS to indirectly point to table COSUS. The default value is 0 to indicate no COS screening is performed. With table MULTICOS, a single MLTCOSID can contain up to 32 COSUS indexes, and therefore COS screening can be performed up to 32 times per call.
HOTLINE		Up to 18 digits(0 to 9)	HOTLINE. If an authcode is associated with a hotline number, enter that number (up to 18 digits). HOTLINE is an option field; if an authcode is not associated with a hotline number, enter a \$.
PVSINDEX		0 to 262140	PRIVATE SPEED INDEX. Enter the speed list number used to identify the private speed list for the authcode. Enter 0, if no speed index is assigned.

AUTHCDU5 (continued)

(Sheet 3 of 5)

Field	Subfield or refinement	Entry	Explanation and action
SATRES		Y or N	<p>SATELLITE RESTRICTED. Enter Y when calls associated with this authcode are restricted from switching through a satellite. Enter N if calls associated with this authcode are permitted to switch through a satellite. If the authcode is satellite restricted (SATRES=Y) and the terminating trunk group uses a satellite (trunk subgroup parameter SAT), then the current route choice will be abandoned and the next route choice is considered for termination.</p> <p>Note: A satellite can be used only once during a call.</p>
FLDONLY		Y or N	<p>AUTHFILED ONLY. Enter Y if authcode can only be used when filed with a trunk group, and cannot be subscriber dialed. If dialed, the call is blocked. Enter N if authcode can be filed by trunk group or dialed by subscriber.</p>
AUTHTRAP		Y or N	<p>AUTHORIZATION TRAP. Enter Y to generate a log report each time an authcode is used. Enter N to disable this feature.</p>
ACCTVAL		Y or N	<p>ACCOUNT CODE VALIDATION. This field determines whether account code validation is required. Validation is performed at the switch by way of table ACSCRN2 or by an SCP.</p> <p>Reference office parameter VALIDATE_ACCT_AT_DMS250 (table OFCVAR) to determine where validation occurs. The default value is N.</p>

AUTHCDU5 (continued)

(Sheet 4 of 5)

Field	Subfield or refinement	Entry	Explanation and action
SPLASHBK		0 to 4	SPLASHBACK. This feature provides the ability to give splashback tone (DTMF) to the Automatic Dialing Machine/Subsequent Address Message (ADM/SAM) subscriber based on the splashback class identifier (0-4) specified in this field. Splashback classes are defined in table SPLASHID. 0 means not a SAM customer. (Splashback Class Identifier 0 is always the value specified when calling party is not an automatic dial machine subscriber.)
TRVALLOW		Y or N	TRAVELING AUTHCODE ALLOWED. This field provides the ability to specify an authcode as a traveling authcode. When the originating trunk group, OPART, and the subscriber's authcode do not match, this field determines if the call should proceed or be blocked. Enter Y when the authcode can be used as a traveling authcode and calls are allowed to proceed if the necessary PIN digits are dialed. Enter N if calls should be blocked.
PININDEX		0 to 8191	PERSONAL IDENTIFICATION NUMBER INDEX. Use this field to associate multiple PIN digits with a subscriber's authcode. This value indexes into table MULTIPIN where the dialed PIN digits are validated. Enter a value when multiple PINs are to be associated with the authcode. The index value must be in the range 1-4095 if the PINLEN field is 2. If the PINLEN field is 3, then the index value must be in the range 4096-8191. Enter 0 when the subscriber is not required to dial PIN digits or the PINDIGS field has a PIN digit value. Note: A value for the PINDIGS and PININDEX fields cannot exist at the same time. If a value for PINDIGS is entered, then the PININDEX and PINLEN fields must be 0; if a PININDEX value (non-zero) is entered, then PINDIGS must be \$, and the PINLEN field must not be 0.

AUTHCDU5 (continued)

(Sheet 5 of 5)

Field	Subfield or refinement	Entry	Explanation and action
PINLEN		0, 2, or 3	PERSONAL IDENTIFICATION NUMBER LENGTH. This field specifies the number of PIN digits to be dialed by the subscriber. Enter a value designated by the length of PIN digits in table MULTIPIN. Enter a 0 when multiple PIN digits are not used.
OPTION			OPTION. This field activates optional features; enter up to 2 options.
		OPCHOICE	OPCHOICE is only available for 0- or 0+ calls to provide alternate routing for operator service calls. When OPTION=OPCHOICE, datafill the OPCHIDX refinement.
	OPCHIDX	0 to 1023	Enter an index into table OPCHOICE. The default is 0.
		CAINGRP	CAIN GROUP. Enter CAINGRP to specify a CAIN subscription group for the authorization code. When OPTION=CAINGRP, datafill the CAINGRP refinement.
	CAINGRP	Valid CAIN group datafilled in table CAINGRP	CAIN GROUP. Enter a valid CAIN group datafilled in table CAINGRP. The authorization code subscribes to CAIN services through the CAIN group.
		CDRTMPLT	CDR TEMPLATE. Use this option to identify the CDR template used to generate CDRs for the specified authcode. Refer to the OPTION=CDRTMPLT section for refinement datafill.

AUTHCDU5 (continued)**OPTION=CDRTMPLT**

When OPTION=CDRTMPLT, datafill the TMPLTIDX and USEEDIT refinements.

Refinement	Subfield or refinement	Entry	Explanation and action
TMPLTIDX		Valid name datafilled in table CDRTMPLT	TEMPLATE INDEX. When SOC option UBFR0001 is enabled, you can use table CDRTMPLT to create new CDR template. For more information on CDR templates, see <i>UCS DMS-250 Billing Records Application Guide</i> .
USEEDIT		N or Y	USE EDIT. Enter N to use the active version of the CDR template. Y indicates that the edit version is used. Note: This field is used for testing purposes only. It should be set to N, which is the default.

Datafill example

The following example shows datafill for table AUTHCDU5.

```
AUTHCODE STATUS ACCTLEN ACSCRIDX OPART TPART PINDIGS MLTCOSID
PVSINDEX SATRES FLDONLY AUTHTRAP ACCTVAL SPLASHBK TRVALLOW PIN
OPTIONS
```

```
4812211 VALID 0 0 981 0 $ 0 $ 51 N N N N 0 Y 0 0 $
```

Table history**UCS13**

Removed UCS07 and UCS07FLEX values from table OPTION=CDRTMPLT (A60007776).

UCS11

The OPCHIDX field is updated. The maximum number of entries is expanded to 1023. (A60006449).

UCS06

Updated to support the following enhancements:

- new MULTICOS table
- expansion of speed list indexes
- Billing Records (flexible CDR)

AUTHDIN

Table name

Authcode Database Index Number (AUTHDIN) table

Functional description

AUTHDIN table assigns an authcode validation to each database call.

The switch determines the authcode database for incoming authcode calls. Call processing determines which AUTHDIN to use by comparing it with the numbers filed in the universal access (subtable STDPRT) or incoming trunk group tables (table TRKGRP field ADIN). The AUTHCODU tables key into table AUTHDIN to identify the database type to associate with the index number. The database can be a specific local switch or a service control point (SCP). The switch receives the authcode record from the appropriate database. The authcode record contains information and feature parameters needed for further call processing.

Table size

AUTHDIN contains up to 100 tuples. Memory statically allocates at 100 words.

Field descriptions

The following table describes field names, subfield names, and valid values for table AUTHDIN.

(Sheet 1 of 2)

Field	Subfield or refinement	Entry	Explanation and action
ADIN		0 to 99	AUTHCODE DATABASE INDEX NUMBER. Enter the number to associate with a particular type of authcode database. This is the key field into the table. The ADIN field in table TRKGRP or Universal Access field in table STDPRT indexes this field.

AUTHDIN (continued)

(Sheet 2 of 2)

Field	Subfield or refinement	Entry	Explanation and action
DBTYPE		see subfield	DATABASE TYPE. Enter the type of authcode database to be associated with the AUTHDIN number. Datafill the AUTHDB subfield.
	AUTHDB	DCP, AUTHCODU, AUTHCDU2, AUTHCDU3, AUTHCDU4, AUTHCDU5	AUTHCODE DATABASE. DCP is not supported on the UCS DMS-250 switch. When AUTHDB=AUTHCODU, AUTHCDU2, AUTHCDU3, AUTHCDU4, or AUTHCDU5, datafill the INSWONLY refinement.

AUTHDB=AUTHCODU, AUTHCDU2, AUTHCDU3, AUTHCDU4, or AUTHCDU5

When AUTHDB=AUTHCODU, AUTHCDU2, AUTHCDU3, AUTHCDU4, or AUTHCDU5, datafill the following refinement:

Refinement	Subfield or refinement	Entry	Explanation and action
INSWONLY		Y or N	IN-SWITCH ONLY. This field displays only when field AUTHDB does not equal DCP. Enter Y for in-switch authcode validation only. Enter N for authcode validation attempt first in-switch and then attempted at the service control point (SCP).

Datafill example

The following example shows datafill for table AUTHDIN.

AUTHDIN (end)

ADIN	DBTYPE
0	DCP
1	AUTHCODU N
2	AUTHCDU2 N
3	AUTHCDU3 N
4	AUTHCDU4 N
5	AUTHCDU5 N
6	AUTHCODU Y
11	AUTHCODU N
12	AUTHCODU N
13	AUTHCODU N

AUTOEXEC

Table name

Automatic File-execution Table

Functional description

The autoexec user function uses table AUTOEXEC as a look-up table. This condition accesses the autologon time and the file name for the automatic run of Support Operating System (SOS) executable files (exec). Table AUTOEXEC automatically transfers the SOS exec and the schedule information to a new BCS load during one-night process (ONP) upgrade.

Datafill sequence and meaning

You do not need to enter data in other tables before you enter data in table AUTOEXEC.

Table size

1 tuple

Datafill

The following table contains datafill for table AUTOEXEC.

Field descriptions (Sheet 1 of 2)

Field	Subfield or refinement	Entry	Explanation and action
AEKEY		AUTOEXEC	<i>AUTOEXEC key.</i> This field is the key to table AUTOEXEC. You can only enter one tuple. Enter AUTOEXEC. The default value is AUTOEXEC.
TIME		see subfields	<i>Start time.</i> This field specifies the time when the autoexec function is logged on and the contents of the SOS exec specified in field EXEC are executed. This field contains subfields HOUR and MINUTE.
	HOUR	0 to 23	<i>Hour.</i> Enter the starting hour for the system to begin the autoexec function. The default value is 3.

AUTOEXEC (continued)

Field descriptions (Sheet 2 of 2)

Field	Subfield or refinement	Entry	Explanation and action
DURATION	MINUTE	0 to 59	<p><i>Minute.</i> Enter the starting minute of the starting hour for the system to begin the autoexec function.</p> <p>The default value is 30.</p>
		1 to 240	<p><i>Duration.</i> Enter the duration in 5 min increases that the autoexec function can log on and execute a file before being forced out.</p> <p>The default value is 55.</p> <p>Note: The field can be set in increases of 1 min. The system reads this entry to the nearest 5 min. For example, the system reads an entry of 7 as 5 min.</p>
USER		alphanumeric (1 to 16 characters)	<p><i>User.</i> Enter the user identification (userID) of the user that schedules the autoexec function. This action makes sure that the autoexec function always uses the userIDs command class, language, and stack. This function uses these commands when the function executes the exec.</p> <p>Note: If the user cannot be determined during dump and restore, or the userID is not correct, the default value becomes ADMIN.</p>
EXEC		alphanumeric (1 to 16 characters)	<p><i>Executable file name.</i> Enter the name of the file in the system file device (SFDEV) that contains the SOS execs that the autoexec function runs.</p> <p>The default value is Undefined_File.</p> <p>Note: This file must be in the SFDEV. To avoid problems with other functions, the name chosen for the file must provide a key to the purpose. The name chosen must provide the name of the person to contact regarding the file.</p>

Datafill example

Sample datafill for table AUTOEXEC appears in the following example.

AUTOEXEC (end)**MAP example for table AUTOEXEC**

AEKEY	TIME	DURATION	USER	EXEC
AUTOEXEC	3	30	55	None Undefined_File

Table history**BCS35**

Table AUTOEXEC was introduced in BCS35.

BCS36

Added note to field DURATION in BCS36.

Additional information

This section provides information on dump and restore precautions when you enter data in table AUTOEXEC. This table contains cautions for the SOS execs for table AUTOEXEC.

Dump and restore

If the file is in the system file device (SFDEV), the SOS exec copies during ONP. If the file does not exist or the file does not copy, warning messages are output and the ONP continues.

Note: The SOS exec must be left in the SFDEV following the ONP to enable the autoexec function.

SOS execs

The SOS execs cannot be scheduled in a method that degrades the primary functions of the switch. The operating company must make sure that the autoexec function does not perform an SOS exec. This SOS exec must not conflict with DMS routines in the areas of real-time operation, call processing, or internal maintenance processes. The operating company must verify the completion of the autolog activity. The autoexec function provides a method to schedule the run of SOS execs. The autoexec function does not make sure that every autologon request is successful. The autoexec function does not make sure that the SOS exec runs correctly.

AUTOHIB

Table name

Autopatcher Uninhibited Log Reports Table

Functional description

Table AUTOHIB represents the log reports that Autopatcher does not inhibit.

Datafill sequence and meaning

You do not need to enter data in other tables before you enter data in table AUTOHIB.

Table size

Memory for this table is allocated dynamically.

Datafill

Datafill for table AUTOHIB appears in the following table.

Field descriptions

Field	Subfield or refinement	Entry	Explanation and action
LOGNAME		alphanumeric (a maximum of 8 characters)	<i>Log group name.</i> Enter the log group name, for example PCH or EXT, and so on.
LOGNUM		-1 to 999	<i>Log number.</i> Enter the log number that associates with the log group. Value -1 specifies every log in a specified log group. The default value for this field is 0 (zero).

Datafill example

Sample datafill for table AUTOHIB appears in the following example.

MAP example for table AUTOHIB

LOGNAME	LOGNUM
MM	100
MM	101
CM	103
CM	111
AUDT	101
AUDT	102

Table history
BCS36

Table AUTOHIB was introduced in BCS36.

AUTOTAB

Table name

Automated Table Audit Table

Functional description

Table AUTOTAB stores the scheduling information for the automated table audit (tabaudit). Each tuple contains a time frame in which the automated tabaudit verifies specified DMS table data integrity.

Enter data in table AUTOTAB through the command interpreter (CI) command TABAUDIT, subcommand TIMEFRAME, at the AUTOTABAUDIT (AUTO) level of the switch.

See table DART for additional information.

Datafill sequence and meaning

You must enter data in table DART before you enter data in table AUTOTAB.

Table size

8 tuples

You cannot increase or decrease the size of table AUTOTAB.

Datafill

Datafill for table AUTOTAB appears in the following table.

Field descriptions (Sheet 1 of 3)

Field	Subfield or refinement	Entry	Explanation and action
SCHEDULE		see subfield	<i>Schedule</i> . This field is the key to the table and contains subfield AUTO_TABAUDIT_KEY.
	AUTO_TAB - AUDIT_KEY	0 to 7	<i>Automated table audit key</i> . This field is the key to the table. Enter the number of the schedule.
TIMEFRAME		see subfield	<i>TimeFrame</i> . This field contains subfield OPTIONS.

AUTOTAB (continued)

Field descriptions (Sheet 2 of 3)

Field	Subfield or refinement	Entry	Explanation and action
	OPTIONS	SINGLE	<p><i>Single.</i> This entry allows users to select a single start time, start date, stop time, and stop date for automated TABAUDIT processing activities.</p> <p>The SINGLE entry has the following values: INITTIME, INITDATE, STOPTIME and STOPDATE</p>
		DAILY	<p><i>Daily.</i> This entry allows users to select a daily start time and stop time for automated TABAUDIT processing activities.</p> <p>The DAILY entry has the following values: INITTIME and STOPTIME</p>
		WEEKLY	<p><i>Weekly.</i> This entry allows users to select a weekly start time, start day, stop time, and stop day for automated TABAUDIT processing activities.</p> <p>The WEEKLY entry has the following values: INITTIME, INITDAY, STOPTIME, and STOPDAY</p>
		MONTHLY	<p><i>Monthly.</i> This entry allows users to select the start time, start date, stop time, and stop date for automated TABAUDIT processing activities.</p> <p>The MONTHLY entry has the following values: INITTIME, INITDATE, STOPTIME, and STOPDATE</p>
	INITDATE	10 alphanumeric characters	<p><i>Initiate date.</i> Enter the date when the automated table audit (TABAUDIT) begins to verify selected tables in the format YYYY:MM:DD. For example, 1993:11:22.</p>
	INITTIME	5 alphanumeric characters	<p><i>Initiate time.</i> Enter the time on the initial date (INITDATE) that automated TABAUDIT begins to verify selected tables in the format HH:MM. For example, 21:00.</p>

AUTOTAB (continued)

Field descriptions (Sheet 3 of 3)

Field	Subfield or refinement	Entry	Explanation and action
	INITDAY	SUN, MON, TUE, WED, THU, FRI, or SAT	<i>Initiate day.</i> Enter the day that automated TABAUDIT begins to verify selected tables with one of the above entries. For example, FRI.
	STOPDATE	10 alphanumeric characters	<i>Stop date.</i> Enter the date that the automated TABAUDIT stops the verification selected tables in the format YYYY:MM:DD. For example, 1993:11:22.
	STOPTIME	5 alphanumeric characters	<i>Stop time.</i> Enter the time on the initial date (INITDATE) that automated TABAUDIT stops the verification selected tables in the format HH:MM, for example, 21:36.
	STOPDAY	SUN, MON, TUE, WED, THU, FRI, or SAT	<i>Stop day.</i> Enter the day that the automated TABAUDIT stops the verification selected tables with one of the entries. For example, FRI.

Datafill example

Sample datafill for table AUTOTAB appears in the following example.

MAP example for table AUTOTAB

SCHEDULE			TIMEFRAME		
0	SINGLE	18:00	1996:07:30	19:00	1996:07:30
1	DAILY	19:30	20:30		
2	WEEKLY	21:30	WED	01:30	THU
3	MONTHLY	16:00	30	17:00	31

Table history
BASE08

Field TIMEFRAME was added to the table. Subfield OPTIONS was added to the table. Entries SINGLE, DAILY, WEEKLY, and MONTHLY were added

AUTOTAB (end)

to the OPTIONS subfield. Entries INITDATE, INITTIME, INITDAY, STOPDATE, STOPTIME, and STOPDAY were added. A new MAP display was added. These entries were added in BASE08.

BCS36

Table AUTOTAB was introduced in BCS36.

Additional information

This section provides information on dump and restore procedures for table AUTOTAB.

Dump and restore

Normal dump and restore procedures apply.

BCCOMPAT

Table name

Bearer Capability Compatibility Table

Functional description

Table BCCOMPAT defines the bearer capability (BC) pairs that are compatible. For example, a terminal with a 300-baud modem BC can communicate with a terminal with a 300- to 1200-baud modem BC.

Default BCs are not always compatible. If you set the bearer capability call screening scope to Integrated Business Network (IBN), special consideration is made for the data unit BC.

Data units can terminate on any station. You cannot remove this capability if modems are used on voice lines. Two selections are available:

- Non-ISDN terminals can have associated synonym directory numbers (DN). This condition is not recommended if ISDN terminals and data units use synonym numbers. This condition impacts the dial plan. In an environment that uses a large number of synonym DNs, the users must know a larger set of numbers to access different services.
- The best selection is to manipulate the BC compatibilities so that none of the current capabilities of data units are lost. Make the data unit BC compatible with the other BCs the data unit can communicate with. This procedure assists users to call data units and data units to call users.

See table BCDEF for additional information and a list of the default BCs.

Datafill sequence and meaning

You must enter data in table BCDEF before you enter data in table BCCOMPAT.

Table BCDEF defines all BCs used in table BCCOMPAT.

Office parameter DEFAULT_BEARER_CAPABILITY in table OFCENG controls the BC default for the office. The two options are SPEECH and 3_1KHZ. See table OFCENG for more information on this parameter.

Table size

2 to 63 tuples

BCCOMPAT (continued)

A maximum of 3906 ($63 \times 63 - 63$) BC pairs are defined. View table BCCOMPAT as a 63×63 matrix of Booleans defining the compatible BC pairs as appears in table Table , "Table matrix for BC pairs" on page -619.

Table matrix for BC pairs

CALLBC	TERMBC									
	1	2	..	17	26	..	63	
1	Y	N	N	N	N	N	N	N	N	N
2	N	Y	N	N	N	N	N	N	N	N
:	N	N	Y	N	N	N	N	N	N	N
17	N	N	N	Y	N	N	1	N	N	N
20	N	N	N	3	Y	N	N	N	N	N
:	N	N	N	N	N	Y	N	N	N	N
26	N	N	N	2	N	N	Y	N	N	N
:	N	N	N	N	N	N	N	Y	N	N
63	N	N	N	N	N	N	N	N	N	Y

Note: TERMBC = terminating bearer capability name
CALLBC = incoming call bearer capability name
Y = BCs are compatible and cannot be changed
N = BCs are not compatible and can be datafilled
1 = CALLBC 17 and TERMBC 26
2 = CALLBC 26 and TERMBC 17
3 = CALLBC 20 and TERMBC 17

Note: BCs are always compatible with other BCs.

Terminals with identical BCs can communicate with each other. Table BCCOMPAT does not display tuples that contain identical BCs. Set the diagonal for the table to Y (yes) at initial program load (IPL) time. The user cannot modify the setting.

Reserve the value 0 (zero) for the NIL_BC BC. Value 0 is not used in table BCCOMPAT.

BCCOMPAT (continued)**Datafill**

The datafill for table BCCOMPAT appears in the following table.

Field descriptions (Sheet 1 of 3)

Field	Subfield or refinement	Entry	Explanation and action
KEY		see subfields	<i>Key.</i> This field contains subfields CALLBC and TERMBC. Separate the two subfields with a space.
	CALLBC	3_1KHZ 7_1KHZ 56KDATA 64KDATA 64KX25 64_RATE_ AD_DATA DATAUNIT SPEECH VOICE_ DATA	<p><i>Incoming call bearer capability name.</i> Enter the BC name (BCNAME) of the incoming call. Enter the BCNAME data in table BCDEF. The BCNAME specifies a user-defined name that describes the BC and can describe the low layer capability.</p> <p>Enter 3_1KHZ for the default BC for calls originated from trunks other than primary rate access (PRA), ISDN user part (ISUP), intermachine trunk (IMT), and dedicated access line (DAL). Use this BC primarily for the transport of speech and voiceband data.</p> <p>Enter 7_1HKZ for voice band high quality audio and voice band data. Use this BC for high quality audio applications like music. You can use this BC for voiceband data.</p> <p>Enter 56KDATA for the basic 56-kbit/s data adapted for 64-kbit/s data. This BC is the North American typical data rate. This BC uses only 7 bits of data sampled at 8000 times per second for the 56-kbit/s rate. The eighth bit of every octet is 1. This condition occurs so that an all 0 (zero) octet does not occur and cause the problems that can occur with 64KDATA.</p>

BCCOMPAT (continued)

Field descriptions (Sheet 2 of 3)

Field	Subfield or refinement	Entry	Explanation and action
	CALLBC (continued)		<p>Enter 64KDATA for ISDN circuit switched packet data calls. This BC is 64 kbit/s of clear channel data. This BC uses all of the 64 kbit bandwidth for data. The 16 following 0s (zero) can occur. Most operating companies in North America use 56 kbit/s data transport because of the problems that can occur with North American repeaters. This action occurs if 16 following 0s (zeros) are received. Use techniques like B8ZS on the data to alleviate the problem.</p> <p>Enter 64KX25 for packet data calls in the X.25 packet network. The encoded data is according to X.25 protocol.</p> <p>Enter 64_RATE_AD_DATA if the data stream contains less than 64 kbit/s and the stream is bit-stuffed to a 64 kbit data rate. Use this BC for applications where the data rate is less than 64 kbit/s (2400, 4800, 9600, 16 000, 19 600, 32 000, 48 000). Use this BC when the remaining bandwidth on the channel is stuffed according to the correct CCITT protocols regarding rate adaption.</p> <p>Enter DATAUNIT for the normal 56KDATA adapted for 64KDATA on primarily non-ISDN data units. This BC is equivalent to the 56KDATA BC.</p>

BCCOMPAT (continued)

Field descriptions (Sheet 3 of 3)

Field	Subfield or refinement	Entry	Explanation and action
	CALLBC (continued)		<p>Enter SPEECH for the default BC for calls that originate from 500/2500 sets and electronic business sets (Northern Telecom multikey business set). Enter SPEECH for the default BC for calls that originate from attendant consoles (Northern Telecom Integrated Business Network (IBN) attendant console). This BC is also assigned to calls over trunks. This BC is for the transport of speech. Use this BC to transport voiceband data, if voice compression techniques are not used on the data.</p> <p>Enter VOICE_DATA for backward compatibility with the DMS-250 feature AD0499 (DAL & IMT Switched 56 KB Data & Multiple PINs per Auth CP). This BC is available in feature packages NTX222AB (DMS-250 Call Processing Type II) and NTX222BA (DMS-250 Call Processing (Type II)). Use this BC on the DMS-250 switch only.</p>
	TERMBC	3_1KHZ 7_1KHZ 56KDATA 64KDATA 64KX25 64_RATE_ AD_DATA DATAUNIT SPEECH VOICE_ DATA	<p><i>Terminating bearer capability name.</i> Enter the BCNAME of the terminator. See field CALLBC for the definition of each BC.</p>

Datavill example

Sample datavill for table BCCOMPAT appears in the following example.

The entry of the following two tuples occurs by default during the loadbuild process.

BCCOMPAT (end)

MAP example for table BCCOMPAT

KEY	
SPEECH	3_1KHZ
3_1KHZ	SPEECH

Table history

BCS36

Verified correct BCs in fields CALLBC and TERMBC in BCS36.

BBTKSGRP

Table name

Blue Box Trunk Subgroup (BBTKSGRP)

Functional description

Table BBTKSGRP contains information for trunk subgroups with Blue Box Fraud (BBF) detection capabilities. Inclusion in table BBTKSGRP enables BBF scanning during trunk termination.

Datafill sequence and implications

There is no requirement to datafill other tables prior to table BBTKSGRP.

Field descriptions

The following table describes field names, subfield names, and valid data ranges for table BBTKSGRP.

(Sheet 1 of 2)

Field	Subfield or refinement	Entry	Explanation and action
SGRPKEY		CLLI and SGRP	SUBGROUP KEY
	CLLI	alphanumeric	COMMON LANGUAGE LOCATION IDENTIFIER. Enter the CLLI of the trunk group to which the subgroup belongs. See table CLLI.
	SGRP	0 or 1	SUBGROUP NUMBER. Enter 0 or 1 for the subgroup number.

BBTKSGRP (continued)

(Sheet 2 of 2)

Field	Subfield or refinement	Entry	Explanation and action
TONEDUR		15-100	<p>TONE DURATION. Enter the minimum duration of the 2600 Hz single frequency (SF) tone for which the Special Tone Receiver (STR) monitors. TONEDUR is specified in 10-millisecond units; in other words, 15 indicates 150 milliseconds. SF tones of duration less than TONEDUR are ignored by the STR.</p> <p>If TONEDUR is set too high, the STR may permit BBF to occur without detection. TONEDUR is too high if it is greater than or equal to the origination filter time on downstream SF trunks; in other words, it is greater than or equal to ODSCFLTR in table TRKGRP of SF trunks on a downstream switch.</p> <p>If TONEDUR is set too low, the STR has an increased probability of interpreting ordinary speech as BBF. In this case, non-fraudulent calls will be erroneously disconnected.</p> <p>The default for this field is 20. Use of the default or greater values for TONEDUR is recommended as long as TONEDUR is less than the origination filter time on downstream SF trunks.</p>
SIGSYS		MF, DTMF, or BOTH	SIGNALING SYSTEM. Enter the signaling system for which to scan.
MINSIG		2-15	Enter the minimum number of signals (digits) for BBF determination.
PARTDIAL		2-40	PARTIAL DIAL TIMING. Enter the time that the STR must wait for the receipt of each digit after the first digit is received.
BLOCKED		Y or N	BLOCKED. Enter Y if the BBF call should be blocked. Enter N if the BBF call should be allowed to go through.

Datafill example

The following example shows sample datafill for table BBTKSGRP.

BBTKSGRP (end)

SGRPKEY		TONEDUR	SIGSYS	MINSIG	PARTDIAL	BLOCKED
MDAL2WDTGS91	1	20	BOTH	4	2	Y
MEAN2WMFWK90	0	30	MF	2	2	N

BCDEF

Table name

Bearer Capability Definition Table

Functional description

Table BCDEF defines the required bearer capabilities (BC). The BCDEF can define a maximum of 59 BCs. The system enters ten default BCs when you enter data in the switch. See the table “Default bearer capabilities” in the Additional information for the default BCs.

Most ISDN calls use a small number of BCs.

Datafill sequence and meaning

You must enter data in table DTUPRO before you enter data in table BCDEF.

Office parameter DEFAULT_BEARER_CAPABILITY in table OFCENG controls the BC default for the office. The default can be SPEECH or 3_1KHZ. See table OFCENG for additional information on this parameter.

Table size

0 to 64 tuples

The table is a fixed size.

BCDEF (continued)**Datafill**

Datafill for table BCDEF appears in the following table.

Field descriptions (Sheet 1 of 5)

Field	Subfield or refinement	Entry	Description
KEY		see subfield	<i>Key.</i> This field contains subfield BCNAME.
	BCNAME	3_1KHZ 7_1KHZ 56KDATA 64KDATA 64KX25 64_RATE_ AD_DATA DATAUNIT NILBC SPEECH VOICE_ DATA	<i>Bearer capability name.</i> This subfield is the key to the table. This subfield specifies a name you define that describes the bearer capability (BC) and can describe the low layer capability. Enter 3_1KHZ for the default BC for calls that originate from trunks other than primary rate access (PRA) and ISDN user part (ISUP). Enter 3_1KHZ for the default BC for calls that originate from trunks other than intermachine trunk (IMT) and dedicated access line (DAL). Use this BC to transport of speech and voiceband data.

BCDEF (continued)

Field descriptions (Sheet 2 of 5)

Field	Subfield or refinement	Entry	Description
			<p>Enter 7_1HKZ for voice band high quality audio and voice band data. Use this BC for high quality audio applications like music. You can use this BC for voiceband data.</p> <p>Enter 56KDATA for the basic 56-kbit/s data adapted for 64 kbit/s data. This data rate is the normal North American data rate. This BC uses 7 bits of data sampled at 8000 times for each second for the 56 kbit/s rate. The eighth bit of every octet is 1. This condition makes sure that an all 0 (zero) octet does not occur. An all 0 (zero) octet can and cause problems with 64KDATA.</p> <p>Enter 64KDATA for ISDN circuit switched packet data calls. This BC is 64 kbit/s of clear channel data. This BC uses the 64 kbit bandwidth for data. The number of consecutive 0s (zero) can be 16. Most operating companies in North America use 56 kbit/s data transport. This condition occurs because of the problems that can occur with North American repeaters if the system receives 16 consecutive 0s (zeroes). Use techniques like B8ZS on the data to make sure the problem is not present.</p>

BCDEF (continued)

Field descriptions (Sheet 3 of 5)

Field	Subfield or refinement	Entry	Description
	BCNAME (continued)		<p>Enter 64KX25 for packet data calls in the X.25 packet network. The system follows the X.25 protocol to encode data.</p> <p>Enter 64_RATE_AD_DATA if the data stream contains less than 64 kbit/s and the stream is bit-stuffed to a 64 kbit/s data rate. Use this BC for applications where the following conditions apply:</p> <ul style="list-style-type: none"> • data rate is less than 64 kbit/s (2400, 4800, 9600, 16 000, 19 600, 32 000, 48 000) • the bandwidth that remains on the channel is stuffed according to the correct CCITT protocols for rate-adaption. <p>Enter DATAUNIT for the basic 56KDATA adapted for 64KDATA on primarily non-ISDN data units. This BC is equivalent to the 56KDATA BC.</p> <p>Enter NILBC if bearer capability is not required for the call, for example, plain ordinary telephone service (POTS) calls.</p> <p>Enter SPEECH for the default BC for calls that originate from 500/2500 sets, electronic business sets or attendant consoles. Electronic business sets can be a Northern Telecom multikey business set. The attendant consoles can be a Northern Telecom Integrated Business Network [IBN] attendant console. This BC is assigned to calls over trunks. Use this BC for the transport of speech. Use this BC to transport voiceband data, if voice compression techniques do not occur on the data.</p>

BCDEF (continued)

Field descriptions (Sheet 4 of 5)

Field	Subfield or refinement	Entry	Description
BCDATA	BCNAME (continued)		Enter VOICE_DATA for backward compatibility with the DMS-250 feature AD0499 (DAL & IMT Switched 56 KB Data & Multiple PINs per Auth CP). The feature is available in feature packages NTX222AB [DMS-250 Call Processing Type II] and NTX222BA (DMS-250 Call Processing [Type II]). Use this BC on the DMS-250 switch.
		see subfields	<i>Bearer capability data.</i> This field contains subfields XFERCAP, XFERMOD, and CODINGST.
	XFERCAP	SPEECH UNRESDIG RESDIG AU3_1KHZ or AU7KHZ	<p><i>Transfer capability.</i> Enter the transfer capability that describes the data that the system transmits.</p> <p>Enter AU3_1KHZ if the system transmits audio data at 3.1 kHz.</p> <p>Enter AU7KHZ if the system transmits audio data at 7 kHz.</p> <p>Enter RESDIG if restricted digital information is required for packet mode calls and most circuit mode data calls. Enter RESDIG if the network with every transparent data transfer capability provides information transfer capability.</p> <p>Enter SPEECH for standard voice calls.</p>
	XFERCAP (continued)		<p>Enter UNRESDIG if packet mode calls and most circuit mode data calls require digital information that is not required. Enter UNRESDIG if restricted digital information refers to the information transfer capability a network capable of 56 kbit/s transparent data transfer.</p> <p>If the entry in field BCNAME is 56KDATA or DATAUNIT, the default value is UNRESDIG.</p>

BCDEF (continued)

Field descriptions (Sheet 5 of 5)

Field	Subfield or refinement	Entry	Description
	XFERMOD	CIRCUIT or PACKET	<p><i>Transfer mode.</i> Enter the transfer mode that describes the mode of transmission.</p> <p>Enter CIRCUIT if the call is a circuit switched call.</p> <p>Enter PACKET if the call is a packet data call.</p> <p>If the entry in field BCNAME is 56KDATA or DATAUNIT, the default value is CIRCUIT.</p>
	CODINGST	CCITT or NETWORK	<p><i>Coding standard.</i> Enter the coding standard for bearer capability and low layer capability.</p> <p>Enter CCITT if the use of CCITT coding standard occurs. Additional datafill is not required.</p> <p>Enter NETWORK if a network specified coding standard is required and datafill refinement PROTOTYP.</p> <p>If the entry in field BCNAME is 56KDATA or DATAUNIT, the default value is NETWORK.</p>
PROTOTYP		DTU MODEM or OTHER	<p><i>Protocol type.</i> Enter the protocol type of the device at the endpoint of the connection.</p> <p>Enter DTU (data terminating unit) and datafill refinements DTUPRO, DTUSYNC, and DTURATE on the next page</p> <p>Enter MODEM (modem) and enter data in refinement MODEMPRO, MODEMSNC, and MODEMRTE in the section "PROTOTYP = MODEM".</p> <p>Enter OTHER (other device) and enter data in refinement DISCRIM in the section "PROTOTYP = OTHER"..</p> <p>If the entry in field BCNAME is 56KDATA or DATAUNIT, the default value is DTU.</p>

BCDEF (continued)**PROTOTYP = DTU**

If the entry in refinement PROTOTYP is DTU, enter data in refinements DTUPRO, DTUSYNC, and DTURATE. See the following description.

Field descriptions for conditional datafill

Field	Subfield or refinement	Entry	Description
	DTUPRO	NONE TLINK or X25	<p><i>Data terminating unit protocol.</i> Enter the DTU protocol used. Define the name that identifies the protocol in table DTUPRO.</p> <p>If the entry in field BCNAME is 56KDATA, the default value is NONE.</p> <p>If the entry in field BCNAME is DATAUNIT, the default value is TLINK.</p>
	DTUSYNC	Y or N	<p><i>Data terminating unit communication.</i> Enter Y (yes) if communication is synchronous. Enter N (no) if communication is asynchronous.</p> <p>If the entry in field BCNAME is 56KDATA or DATAUNIT, the default value is Y.</p>
	DTURATE	75BS, 150BS, 300BS, 600BS, 1200BS, 2400BS, 3600BS, 4800BS, 7200BS, 16KBS, 9600BS, 14400BS, 16KBS, 19200BS, 32KBS, 48KBS, 8KBS, or AUTO	<p><i>Data terminating unit data rate.</i> Enter the data access rate of the modem.</p> <p>If the entry in field BCNAME is 56KDATA or DATAUNIT, the default value is 56KBS.</p>

BCDEF (continued)**PROTOTYP = MODEM**

If the entry in refinement PROTOTYP is MODEM, enter data in refinements MODEMPRO, MODEMSNC, and MODEMRTE. See the following description.

Field descriptions for conditional datafill

Field	Subfield or refinement	Entry	Description
	MODEMPRO	alphanumeric (a maximum of 32 characters)	<i>Modem protocol.</i> Enter the modem protocol used. Define the name that identifies the protocol in table MODEMPRO.
	MODEMSNC	Y or N	<i>Modem communication.</i> Enter Y (yes) if communication is synchronous. Enter N (no) if communication is asynchronous.
	MODEMRTC	75BS, 150BS, 300BS, 600BS, 1200BS, 2400BS, 3600BS, 4800BS, 7200BS, 16KBS, 9600BS, 14400BS, 16KBS, 19200BS, 32KBS, 48KBS, 56KBS, 8KBS, or AUTO	<i>Modem data rate.</i> Enter the modem data access rate.

BCDEF (continued)**PROTOTYP = OTHER**

If the entry in refinement PROTOTYP is OTHER, enter data in refinement DISCRIM. See the following description.

Field descriptions for conditional datafill

Field	Subfield or refinement	Entry	Description
DISCRIM		0 to 63	<i>Discriminator.</i> Enter a positive integer value. Use the value entered as a discriminator between the different OTHERs.

Datafill example

Sample datafill for table BCDEF appears in the following example.

See the following table “Default bearer capabilities” for a list of the default tuples. The addition of a tuple during load build appears in the following example.

MAP example for table BCDEF

KEY	BCDATA
SPEECH	SPEECH CIRCUIT CCITT

Table history**BCS36**

The following changes occurred in table BCDEF in BCS36:

- default values in field BCNAME
- default values for protocol type DTU
- explanation of default bearer capabilities
- explanation of synonym DNs

Additional information

This section provides information on how to enter default bearer capabilities in table BCDEF. This section also provides product descriptive information related to table BCDEF.

BCDEF (continued)**Default bearer capabilities**

Table “Default bearer capabilities” contains the order of the ten default BCs the system enters in table BCDEF. The order of the default BCs is order-dependent. The operating company cannot change the datafill. This condition applies because constants are set up in the software code for each of default BC.

The system enters the ten default BCs when the switch is booted.

The operating company can enter additional BCs in any order.

Default bearer capabilities

BCNAME	XFERCAP	XFER-MODE	CODINGST	PROTO TYPE	DTU-PRO	DTU-SYNC	DTU-RATE
SPEECH	SPEECH	CIRCUIT	CCITT				
64KDATA	UNRESDIG	CIRCUIT	CCITT				
64KX25	RESDIG	CIRCUIT	NETWORK	DTU	X25	Y	AUTO
56 KDATA	UNRESDIG	CIRCUIT	NETWORK	DTU	NONE	Y	56KBS
DATAUNIT	UNRESDIG	CIRCUIT	NETWORK	DTU	TLINK	Y	56KBS
64KRES	RESDIG	CIRCUIT	CCITT				
3_1KHZ	AU3_1KHZ	CIRCUIT	CCITT				
7_KHZ	AU7KHZ	CIRCUIT	CCITT				
VOICE_ DATA	AU3_1KHZ	CIRCUIT	CCITT				
64K_RATE _AD_DATA	UNRESDIG	CIRCUIT	CCITT				

Synonym directory numbers

The ISDN terminals can have more than one call appearance with the same DN and with different BCs. Intra-ISDN calls terminate on call appearances. The BC of the incoming call and on the BC of the terminator determines if calls terminate on call appearances. The originator of a call to an ISDN terminal can require that the originating BC be different from the default BC. For example, data calls that go over trunks, or MODEM use on voice lines.

BCDEF (end)

Use one of the following two methods to specify different BCs:

1. In an IBN environment, dial a feature access code and the DN of the desired party. This method is not compatible with current POTS dial plans.
2. Enter a set of synonym DNs for terminals to receive calls from non-ISDN terminals or other ISDN networks. When one of these synonym DNs is called, the BC associated with the synonym DN replaces the original call. The call terminates on the desired call appearance (CAP) on the ISDN terminal. Each ISDN terminal with more than one CAP with the same DN but with different BCs can use synonym numbers associated with a BC. Each synonym DN is different. To terminate on a CAP with the desired BC, the synonym DN associated with that BC is dialed.
 - a. Define synonym DNs with the following function: (synonym DN) = actual DN + BC

BCHNLMEM

Table name

B-Channel Member (BCHNLMEM) table

Functional description

PRA250 Member range screening and routing lets the switch divide a Primary Rate Interface (PRI) trunk into member ranges. Each member range can have a separate Logical Terminal Group Number (LTNUM) and Serving Numbering Plan Area (SNPA) assigned while sharing a single D-Channel for signalling. Functionality activated through table CALLATTR can be different for each range of members. Calls terminated to a PRI trunk, can be terminated to certain member ranges based on translation of address digits.

Table BCHNLMEM allows each PRA250 trunk group to be divided into 32 member range groups to allow different screening processing, and trunk member selection for each set of ranges.

The 3-part key to this table is a PRA250 Common Language Name (CLLI), the member's upper range member, and the lower range member. The fields MEMCLLI, LTNUM, and SNPA are listed below:

- MEMCLLI. This field can contain any CLLI name datafilled in table CLLI. The MEMCLLI name may be used only once per trunk group in this table.
- LTNUM. The LTNUM field contains the Logical Terminal Number (LTNUM) in a group.
- SNPA. The SNPA field contains the Serving Numbering Plan Area (SNPA). This field overrides the SNPA from table TRKGRP when the BCHNLMEM table is used for PRI originations.

Table size

Minimum table size is 20 tuples. Maximum table size is 65,000 tuples

Data entry sequence and implications

Datafill table CLLI before you assign a CLLI to the MEMCLLI field.

BCHNLMEM (continued)**Field descriptions**

The following table describes field names, subfield names, and valid data ranges for table BNCHLMEM.

Field descriptions

Field	Subfield or refinement	Entry	Explanation and action
KEY			KEY. Enter datafill into the MEMCLLI, LTNUM, and SNPA subfields.
	MEMCLLI	Any CLLI Member names datafilled in table CLLI	MEMBER CLLI. Each member range group is assigned a unique MEMBER CLLI. Use any CLLI name datafilled in table CLLI. Default values: not applicable.
	LTNUM	1 to 1022	LTNUM. The LTNUM field contains the Logical Terminal Group Number. LTNUM is paired with the Logical Terminal Group (LTGRP) datafilled in table TRKGRP for the actual trunk member the range applies. This combination is used to index into LTCALLS for originating and terminating calls over the PRA250 trunk. Default values: not applicable.
	SNPA	000 to 999	SNPA. The SNPA field contains the Serving Numbering Plan Area. This field overrides the SNPA form table TRKGRP when the BCHNLMEM table is used for PRI originations. Default value: 001.

Data example

The following example shows sample data for the BCHNLMEM table.

BCHNLMEM (end)

MAP display example for table BCHNLMEM

```
CLLIKEY MEMCLLI LTNUM SNPA  
-----  
PRI1920DRNO 1 12 MEMBERTRK 1 214
```

Table history **UCS14**

Created table BCHNLMEM (S60324154).

BEARNETS

ATTENTION

This table applies to new or modified content for SN07 (UCS) that is valid through the current release.

Bearer Networks supported

Table Bearer Networks (BEARNETS) identifies the bearer networks supported by the server and the network options that apply to the packet networks on a succession call server.

The overall default packet network for the office is determined by the assignment of the `packet_network_default` option to a single tuple in the table. If no packet network is detected in the provisioning hierarchy for a packet agent, this default packet network will be used.

Datafill sequence and meaning

The tables must be datafilled in the following sequence:

- ENINV
- CLLI
- BEARNETS
- NETBRDGE
- NETPATH
- NET2NET
- MNNODE
- SERVRINV
- TRKOPTS

Table size

8 tuples maximum (memory is not allocated unless tuples are provisioned, that is, `NETWORK_ACTIVE = EXTENET`)

Datavfill

The following table lists the datavfill for table BEARNETS.

Field, subfield, and refinement descriptions for table BEARNETS (Sheet 1 of 2)

Field	Subfield or refinement	Entry	Explanation and action
NETIDX		0 to 7	<p>This field defines the key to the table, and entries are displayed as "NET 0" to "NET 7".</p> <p>Adding a tuple in table BEARNETS automatically creates a tuple in table NET2NET with \$.</p> <p>You can not delete a BEARNETS tuple unless the NET2NET entry contains a \$, and that tuple is the only reference.</p>
BNETNAME		vector of up to 32 characters	<p>This field identifies the name of the bearer network. This name is used in other tables to reference the associated bearer network and its characteristics. Making the name a field of the tuple rather than the index allows you to make name changes to the networks defined.</p> <p>The 32 character name of the network must be unique across the table.</p>
DISPLAY		vector of up to 4 characters	<p>This field identifies the a 4 character string that will be used to display the bearer network on the MAP screens. You must define a unique string across the bearer networks, which is implemented in table control.</p>
FABRIC		ENET, AAL1, AAL2, or IP	<p>The field defines the bearer network fabric type. Only one ENET tuple is allowed, an ENET tuple can be added only if ENET exists in the network.</p>

Field, subfield, and refinement descriptions for table BEARNETS (Sheet 2 of 2)

Field	Subfield or refinement	Entry	Explanation and action
OPTIONS		vector of {pkt_network_default}	This field defines the vector of the options against the bearer network.
	pkt_network_default		<p>This subfield indicates that this tuple is the packet bearer network default for the office. It is primarily used in initializing dependant tables during an ONP. The first packet network added is the default packet.</p> <p>Only one tuple may have this option assigned. If the option is added to another tuple, the option is removed from the first tuple.</p> <p>You can remove this option from a tuple only by assigning it to another tuple. Also, you can delete the network default tuple only if it is the last remaining packet network tuple.</p> <p>Note: This option can not be assigned if FABRIC = ENET.</p>

Datafill example

The following example shows sample datafill for table BEARNETS.

MAP display example for table BEARNETS

NETIDX	NETNAME	DISPLAY	FABRIC	OPTIONS
NET 0	TDM_ENET	ENET	ENET	\$
NET 1	NET_AAL1	ATM	AAL1	(PKT_NETWORK_DEFAULT) \$
NET 2	NET_IP	IP	IP	\$
NET 3	NET_AAL2	AAL2	AAL2	\$

Supplementary information

Table BEARNETS, along with tables NETBRDGE, NETPATH, and NET2NET, is required to be provisioned in all Succession sites supporting bridged calls from a TDM network to a packet network.

When using the FINDREF tool on table BEARNETS, you must encapsulate the key field within single parentheses. For example:

```
FINDREF BEARNETS 'NET 1'
```

On an ONP, this table is provisioned automatically both TDM and packet networks tuples where they exist.

- If the from side datafill contained an ENET, the NET 0 tuple from the datafill example will be provisioned automatically
- If the from side supported packet nodes (as indicated by the setting of the PRE_SN07_DUMPSIDE_NETWORK_FABRIC), the NET 1 tuple will be provisioned and marked as the PKT_NETWORK_DEFAULT

Table history

SN07 (DMS)

New table BEARNETS is created as part of activity Q01083765.

BLDDATA

Table name

Build Data (BLDDATA)

Functional description

A dump and restore of a datafill table can occur more than one time during the one-night process (ONP). When this event occurs, the table is a recursive table. A table that the system identifies as a recursive table informs the ONP. The table informs the ONP that when a tuple fails during the transfer, the tuple must transfer later during the data transfer. Movement of these tables occurs again when other tables execute the post table procedures. The system cannot restore one tuple of a recursive table the first time. Restoration of the *entire* table must occur next time.

Table BLDDATA stores tuples for restoration during the ONP data transfer process. The restore side of the process release can match the release number of the specified tuple in table BLDDATA. When this event occurs, the data transfer proceeds in table BLDDATA to restore the tuple to the appropriate table.

Table BLDDATA reduces the time required to apply data requests in the loadbuild cycle. This reduction occurs when the operating company enter a previous software release with new data. In addition, this table reduces the probability of errors. To reduce errors, the table allows the addition of tuples that use command NEWDATA:INCLUDE. The table limits this time because the table provides a structure to facilitate the transfer of the tuple. This table integrates the tuple into memory. The table does not integrate the tuple in a DMOPRO type file.

Note: Table BLDDATA is a read-only table and is not for end users. Northern Telecom enters data in this table. Northern Telecom technicians must perform modifications to this table.

Datafill sequence and meaning

You do not need to enter data in other tables before you enter data in table BLDDATA.

Table size

Table BLDDATA uses segmented store structure. The system creates this table by continuous adjustment. The system increases the table when the entry of a data request cannot occur in a previous software release. The minimum size of this table is one tuple. This table has 80 bytes of store.

BLDDATA (continued)

The maximum number of tables is 1400. Each table has a representation in a tuple ID structure of 80 bytes. The maximum size of the link list of tuples is 64k bytes of segmented store.

Datafill

Datafill for table BLDDATA appears in the following table.

Field descriptions

Field	Subfield or refinement	Entry	Explanation and action
BLDKEY	see subfields		Building key. This field has subfields TABNAME, TUPLENUM and PARTNUM.
	TABNAME	alphanumeric	Table name. This subfield identifies the name of the table from which the addition of tuples to table BLDDATA originates.
	TUPLENUM	positive integers	Tuple number. This subfield identifies the number of the tuple of the table entered in subfield TABNAME. This value represents the numerical order of the tuple in the specified table.
	PARTNUM	positive integers	Part number. This subfield identifies the part number of the tuple of the table entered in subfield TABNAME. This value represents the numerical order of the part of the specified tuple.
RELNUM		numeric	Release number. This field identifies the software release number.
OPERATIN		ADD, DEL, PUT, UPD	Operation. This field determines the treatment of the tuple in the table. The ADD refers to the addition of the tuple to the specified table. The DEL refers to the deletion of the tuple in the specified table. The UPD refers to the update of a tuple in the specified table. The PUT refers to the replacement of a tuple.
TUPDATA			Tuple data. The entry in TABNAME determines this field. The tuple data corresponds to the name of the table specified in TABNAME.

BLDDATA (end)**Datafill example**

Sample datafill for table BLDDATA appears in the following example.

MAP example for table BLDDATA

	BLDKEY	RELNUM	OPERATN TUPDATA
	LTCPSINV 1 1	TOPO4	PUT
TMS 2 N 0 DS1 DEFAULT N 1 DS1 DEFAULT N 2 DS1 DEFAULT N 3 DS1 DEFAULT N			

Table history**BASE03**

Initial release of this table is in accordance with Workstation to Workstation Data Transfer in BASE03.

Additional information

When a request of new data for a table occurs, the system dumps the table in a DMOPRO type file. This file contains previous and current data. When the user executes the INCLUDE command, the system opens the file and performs a read.

Type version checking occurs. When the system does not detect a mismatch in the type versions, the file is RESTABED into the previous software release. When the system detects a type version mismatch, the system creates table BLDDATA.

When the start of the dump and restore process begins, the release side attempts to restore the tuples in table BLDDATA. This event occurs after the restoration of each corresponding table.

Note: The restore process of table BLDDATA tuples can occur after resthe restoration of each table. The LOADBUILD report reports error messages associated with tuples. In addition to the error messages, the LOADBUILD report identifies the defective tuple.

C7AFTPC

Table name

CCS7 Gateway STP SCCP Management Affected Point Code Screening Table

Functional description

Table C7AFTPC screens messages in American National Standards Institute (ANSI) and NTC7 format. It defines the gateway screening functions for the signaling connection control part (SCCP) management (SCMG) affected point code.

Note: All references to signaling transfer point (STP) are applicable to the STP/Service Switching Point (SSP) Integrated Nodes (INode), unless otherwise specified.

For related information, refer to table C7GTWLKS.

Datafill sequence and implications

The following table must be datafilled after table C7AFTPC.

- C7CDPA

Table size

Up to 32 767 tuples

Up to 2000 tuples in INode

The limit of 2000 tuples for this table depends on the datafill in the other gateway screening tables.

The limit of 32 767 tuples for this table depends on the datafill in the other gateway screening tables and has the following restrictions:

- up to 1024 screening references for all tables
- up to 256 rules for each screening reference

C7AFTPC (continued)**Datafill**

The following table lists datafill for table C7AFTPC.

Field descriptions (Sheet 1 of 4)

Field	Subfield or refinement	Entry	Explanation and action
SCRNREF		see subfields	<i>Screening reference.</i> This field consists of subfields REFERNCE and RULENO.
	REFERNCE	alphanumeric (1 to 4 characters)	<i>Screening reference.</i> Enter a value that identifies a signaling connection control part (SCCP) management (SCMG) affected point code screening function.
	RULENO	0 to 255	<i>Rule number.</i> Enter a number to identify a rule within a screening function. Each screening function can consist of up to 256 distinct rules.
SCRNRULE		see subfields	<i>Screening rule.</i> This field contains all of the screening rule information and consists of subfields NETTYPE, FROMPC, TOPC, FROMSSN, and TOSSN.
	NETTYPE	ANSI7 or NTC7	<i>Network type.</i> Enter ANSI7 if the screened point codes are in ANSI format. This table is not used for screening messages in the CCITT format. Enter NTC7 if the point codes being screened are in the NTC7 format.
	FROMPC	a vector from 0 to 3 values in the range 0 to 255	<i>From point codes.</i> If the NETTYPE is ANSI7, enter a full or partial point code (PC) representing the start of the range of SCMG affected point codes to which this rule applies. Up to three values can be datafilled. If less than three values are required, end the list with a \$. Note: For NTC7 network types, only a full PC is valid. The \$ (dollar sign) symbol is not accepted. The value of subfield FROMPC must be less than or equal to the value of subfield TOPC.

C7AFTPC (continued)

Field descriptions (Sheet 2 of 4)

Field	Subfield or refinement	Entry	Explanation and action
	TOPC	a vector from 0 to 3 values in the range 0 to 255	<p>Note: The following additional restrictions are applied to each tuple only if they have the network type ANSI7 and if the Signaling, Engineering, and Administration System (SEAS) software is present in the STP:</p> <ul style="list-style-type: none"> • The network identifier of fields FROMPC and TOPC must be in the range 1 to 255 (a value of 0 (zero) is not valid). • The point code range represented by fields FROMPC and TOPC can only be one of the following types of ranges: <ul style="list-style-type: none"> — a single PC range of, or all of, the PCs in a Network Cluster — a range of, or all of, the Network Clusters in a Network Identifier — a range of, or all of, the Network Identifiers in the entire range of PCs <p><i>To point codes.</i> Enter a full or partial PC representing the end of the range of SCMG-affected point codes to which this rule applies. End the vector with a blank space and a \$.</p> <p>Note: For NTC7 network types, only a full PC is valid. The \$ symbol is not accepted.</p> <p>The value of subfield TOPC must be greater than or equal to the value of subfield FROMPC.</p>

C7AFTPC (continued)

Field descriptions (Sheet 3 of 4)

Field	Subfield or refinement	Entry	Explanation and action
			<p>Note: The following additional restrictions are applied to each tuple only if they have the network type ANSI7 and if the Signaling, Engineering, and Administration System (SEAS) software is present in the STP:</p> <ul style="list-style-type: none"> • The network identifier of fields FROMPC and TOPC must be in the range 1 to 255 (a value of 0 (zero) is not valid). • The point code range represented by field FROMPC and TOPC can only be one of the following types of ranges: <ul style="list-style-type: none"> — a single PC range of, or all of, the PCs in a Network Cluster — a range of, or all of, the Network Clusters in a Network Identifier — a range of, or all of, the Network Identifiers in the entire range of PCs
	FROMSSN	0 to 255or \$	<p><i>From subsystem number.</i> Enter the first subsystem number in the range of subsystem numbers to which this rule applies.</p> <p>The value in subfield FROMSSN must be less than the value in subfield TOSSN.</p> <p>If the rule includes all subsystem numbers, enter \$ (no subsystem numbers specified).</p>
	TOSSN	0 to 255or \$	<p><i>To subsystem number.</i> Enter the last subsystem number in the range of subsystem numbers to which this rule applies.</p> <p>The value in subfield TOSSN must be greater than the value in subfield FROMSSN.</p> <p>If the rule includes all subsystem numbers, enter \$ (no subsystem numbers specified).</p>

C7AFTPC (continued)**Field descriptions (Sheet 4 of 4)**

Field	Subfield or refinement	Entry	Explanation and action
REMARKS		alphanumeric (1 to 8 characters)	<i>Remarks.</i> This field is specified by the operating company and can be used to identify the name of the network or carrier to which the link is connected. Any eight-character value can be stored in this field. Avoid the use of special characters, such as +, *, /, -, and %.
OPTIONS		see subfields	<i>Options.</i> This field consists of subfield OPTNAME.
	OPTNAME	\$	<i>Option name.</i> Enter \$, which is the only valid entry.

Datafill example

The following example shows sample datafill for table C7AFTPC.

The example consists of screening for affected point codes. This screening is performed only if the called party address of the message is 1 and the service indicator of the message is 3.

If the message being screened matches the rule, the screening is finished and the call is routed normally.

No screening options are required, so \$ is entered in subfield OPTNAME.

C7AFTPC (continued)**MAP display example for table C7AFTPC**

SCRNREF	SCRNRULE	REMARKS
OPTIONS		
REF9 1	ANSI7 (1) (1) (4)\$ (1) (1) (5)\$ (251)\$ (251)\$	\$
		\$
REF9 2	ANSI7 (1) (1) (8)\$ (1) (1) (10)\$ (251)\$ (251)\$	\$
		\$
REF9 3	ANSI7 (1) (1) (18)\$ (1) (1) (20)\$ (251)\$ (251)\$	\$
		\$
REF9 4	ANSI7 (1) (1) (23)\$ (1) (1) (28)\$ (251)\$ (251)\$	\$
		\$
REF9 5	ANSI7 (1) (1) (29)\$ (1) (1) (30)\$ (251)\$ (251)\$	\$
		\$

Table history**STP04.0**

Removed references to MDR7 screening.

CSP06

Removed information about bulk deletion workaround.

CSP02

Added information about the possibility of service degradation if gateway screening is not turned off.

BCS36

Added information about bulk deletions.

Supplementary information

This section provides information on modifying datafill in table C7AFTPC.

C7AFTPC (end)

Datafill modifications



DANGER

Risk of service degradation

A service degradation can occur if gateway screening is not turned off in table C7GTWLKS prior to making additions, deletions, or changes to table C7AFTPC.

The table control warning is displayed at the MAP display if a user attempts to add, change, or delete tuples in table C7AFTPC.

A similar message is displayed in all the gateway screening tables (C7AFTPC, C7ALWDPC, C7ALWGTT, C7ALWOPC, C7ALWSIO, C7BLKDPC, C7BLKOPC, C7BLKSIO for CCITT only, C7CDPA, C7CGPA, and C7DSTFLD).

Note: The VERIFY function must be turned on. If VERIFY is off, the above warning is not displayed.

C7ALIAS

Table name

CCS7 Capability Codes Table

Functional description

Table C7ALIAS allows a Common Channel Signaling 7 (CCS7) signal transfer point (STP) to identify itself by more than one point code. This table contains the additional point codes, called capability codes, that can be used to address the STP. The originating point code (OPC) is not datafilled in this table, since this point code is already datafilled in table C7NETWRK.

If this table is not datafilled, it has no effect on the operation of the STPs.

A node in a CCS7 network can only accept messages destined for it by comparing the destination point code in the message against the single point code that is the network address of the node.

Table C7ALIAS allows the node to accept messages that are destined for its point code and also those messages that are destined for a capability code. A capability code is fully specified by a network name, as datafilled in table C7NETWRK, the network type, and a vector of three integers. These three integers have different ranges depending on the network type that is entered.

A point code that is used as a capability code cannot be used as a network identifier as defined in table C7NETWRK, or as a routing destination as defined in table C7RTESET.

New tuples can be added to table C7ALIAS only if the node type that is datafilled in table C7NETWRK contains a subset of STP for the given network.

Datafill sequence and implications

Table C7NETWRK must be datafilled before table C7ALIAS.

If STP SOC is present, table C7ALIAS is visible on an SSP. The table can be datafilled whether STP SOC is ON or IDLE, but functionality is only available when STP SOC is set to ON.

Table size

0 to 1024 tuples

Maximum table size is fixed at 256 alias tuples for each network tuple.

C7ALIAS (continued)**Datafill**

The following table lists datafill for table C7ALIAS.

Field descriptions

Field	Subfield or refinement	Entry	Explanation and action
ALIAS		see subfields	<i>Alias</i> This field contains the additional point codes, called capability codes, that can be used to address the STP, in addition to the originating point code that is datafilled in table C7NETWRK. This field consists of subfields NETNAME and PTCODE.
	NETNAME	alphanumeric (1 to 16 characters)	<i>Network name</i> Enter the network name, previously datafilled in table C7NETWRK, to identify the network to which this capability code belongs.
	PTCODE	see subfield	<i>Capability point code</i> This field consists of subfield NETTYPE.
	NETTYPE	ANSI7, CCITT7, NTC7, JPN7, or TTC7	<i>Network type</i> Enter the network type and datafill the subfields of refinement NETTYPE. If the network type is North American, enter ANSI7 and datafill subfields NETWORK, CLUSTER, and MEMBER, which make up the far-end point code. If the network type is international, enter CCITT7 and datafill refinement FORMAT and its refinements. If the network type is telecommunication technology committee signaling system 7 (TTC7), used in Japan on the DMS-250, enter TTC7 and datafill refinements MAINAREA, SUBAREA, and AREAUNIT, which make up the far-end point code.

C7ALIAS (continued)**NETTYPE=ANSI7**

If the entry in subfield NETTYPE is ANSI7, datafill the refinements NETWORK, CLUSTER and MEMBER.

Field descriptions for conditional datafill

Field	Subfield or refinement	Entry	Explanation and action
	NETWORK	0 to 255	<i>Network identifier</i> Enter the number of the network identifier that is assigned to the far-end switching unit of the specified network.
	CLUSTER	0 to 255	<i>Cluster identifier</i> Enter the number of the network identifier cluster that is assigned to the far-end switching unit of the specified network.
	MEMBER	0 to 255	<i>Member</i> Enter the number of the cluster member that is assigned to the far-end switching unit of the specified network.

C7ALIAS (continued)**NETTYPE=CCITT7**

If the entry in subfield NETTYPE is CCITT7, datafill the subfields FORMAT, and its refinements.

Field descriptions for conditional datafill (Sheet 1 of 3)

Field	Subfield or refinement	Entry	Explanation and action
	FORMAT	AUSTRIA BASIC INTL CHINA orGERMAN	<p><i>CCITT format</i></p> <p>This field specifies the CCITT7 point code refinements that are required for the network.</p> <p>If the point code used is for Austria, enter AUSTRIA and datafill refinements ZONE, REGION, and SIGPOINT.</p> <p>If the point code used is based on one field, enter BASIC and datafill refinement PC.</p> <p>If the point code used is for China, enter CHINA and datafill refinements ZONE, EXCHANGE, and SIGPOINT.</p> <p>If the point code used is international, enter INTL and datafill refinements ZONE, AREANETW, and SIGPOINT.</p> <p>If the point code is for Germany, enter GERMAN and datafill refinements NUMAREA, HVST, KVST and SIGPOINT.</p>
	ZONE	0 to 31	<p><i>Zone identifier</i></p> <p>Enter the zone identifier that is assigned to the far-end switching unit for the specified network.</p> <p>If the entry in subfield FORMAT is AUSTRIA, the range is 0 to 31.</p> <p>If entry in field FORMAT is CHINA, the range is 0 to 15.</p> <p>If the entry in field FORMAT is INTL, the range is 0 to 7.</p>
	PC	0 to 16383	<p><i>Point code</i></p> <p>If the entry in subfield FORMAT is BASIC, enter the number of the FEPC that has been assigned to the far-end switching unit for the specified network.</p>

C7ALIAS (continued)**Field descriptions for conditional datafill (Sheet 2 of 3)**

Field	Subfield or refinement	Entry	Explanation and action
	REGION	0 to 15	<i>Region</i> If the entry in subfield FORMAT is AUSTRIA, enter the number of the region that has been assigned to the far-end switching unit for the specified network.
	EXCHANGE	0 to 127	<i>Exchange</i> If the entry in subfield FORMAT is CHINA, enter the number of the exchange in the zone that has been assigned to the far-end switching unit for the specified network.
	AREANETW	0 to 255	<i>Area/network identifier</i> If the entry in subfield FORMAT is INTL, enter the number of the area/network identifier in the zone that has been assigned to the far-end switching unit for the specified network.
	NUMAREA	0 to 15	<i>Numbering Area</i> If the entry in subfield FORMAT is GERMAN, enter the area number assigned to the office.
	HVST	0 to 7	<i>HVSt</i> If the entry in subfield FORMAT is GERMAN, enter the HVSt number assigned to the office.

C7ALIAS (continued)**Field descriptions for conditional datafill (Sheet 3 of 3)**

Field	Subfield or refinement	Entry	Explanation and action
	KVST	0 to 15	<i>KVSt</i> If the entry in subfield FORMAT is GERMAN, enter the KVSt number assigned to the office.
	SIGPOINT	0 to 31	<i>Signal point identifier</i> If the entry in subfield FORMAT is AUSTRIA, enter the number of the signal point in the region that has been assigned to the far-end switching unit for the specified network. The range is 0 to 31. If the entry in subfield FORMAT is CHINA, enter the number of the signal point in the exchange that has been assigned to the far-end switching unit for the specified network. The range is 0 to 7. If the entry in subfield FORMAT is GERMAN, enter the number of the signal point in the exchange that has been assigned to the far-end switching unit for the specified network. The range is 0 to 7.

C7ALIAS (continued)**NETTYPE=TTC7**

If the entry in subfield NETTYPE is TTC7, datafill the subfields MAINAREA, SUBARREA, and AREAUNIT.

Field descriptions for conditional datafill

Field	Subfield or refinement	Entry	Explanation and action
	MAINAREA	0 to 31	<i>Main area</i> If the entry in subfield NETTYPE is TTC7, enter the number of the main area. This is the first part of the capability code for the TTC7 signaling used in Japan on the DMS-250 switch.
	SUBAREA	0 to 15	<i>Subarea</i> Enter the number of the subarea of the main area that has been assigned to the far-end switching unit for the specified network. This is the second part of the capability code for the TTC7 signaling used in Japan on the DMS-250 switch.
	AREAUNIT	0 to 127	<i>Area unit</i> Enter the number of the area unit in the sub-area that has been assigned to the far-end switching unit for the specified network. This is the third part of the capability code for the TTC7 signaling used in Japan on the DMS-250 switch.

Datafill example

The following example shows sample datafill for table C7ALIAS.

The example consists of two capability codes for a North American network, C7NETWRK1.

C7ALIAS (continued)**MAP display example for table C7ALIAS**

ALIAS				
C7NETWRK1	ANS17	1	0	255
C7NETWRK1	ANS17	2	2	63

Table history**TL08**

Added STP SOC note.

TL06

Error messages were updated to require STP capability in table C7NETWRK.

Supplementary information

This section provides information on datafilling table C7ALIAS for specific applications, and product descriptive information related to table C7ALIAS.

Error messages

If the name entered in subfield NETTYPE does not match the network name that is entered in table NETTYPE, then the following error message is displayed.

NETTYPE does not match the C7NETWRK table entry.

If a capability code with the same point code as the network originating point code is entered, then the following error message is displayed.

Point Code is already in the C7NETWRK table.

If a capability code with the same point code as a routeset destination point code is entered, then the following error message is displayed.

Point Code is already in the C7RTESET table.

If any of the above error messages occur, compare the data being entered with the data that is stored in tables C7NETWRK and C7RTESET. Correct the data for the capability code that is being entered in table C7ALIAS.

C7ALIAS (end)

If the operating company enters a NETNAME that is not datafilled in the C7NETWRK table, then the following error message is displayed.

```
NETWORK not datafilled.
```

If the operating company tries to use the change command, the following error message is displayed.

```
NO fields of the C7ALIAS table are modifiable.
```

If the node type datafilled in table C7NETWRK does not contain STP capability, then tuples cannot be datafilled in table C7ALIAS. If the node type datafilled in table C7NETWRK does not contain STP capability, the following error message is displayed.

```
Invalid operation for node type.
```

Display of table C7ALIAS using the list command

When using the table editor list command, the entries in table C7ALIAS are not displayed in the same order in which they are entered. Instead, they are sorted. All capability codes that are associated with the same network are grouped together. These groups are displayed based on the order of the network within table C7NETWRK. The point codes within each group are sorted by least significant field first. With an ANSI7 point code the member field is sorted first, then the cluster, then the network field. The ordering is described in the following table.

Network order within table C7NETWRK

Entered in this order	Displayed in this order
NETWORK ANSI7 1 1 64	NETWORK1 ANSI7 5 5 62
NETWORK ANSI7 1 2 64	NETWORK1 ANSI7 2 2 63
NETWORK ANSI7 2 1 64	NETWORK1ANSI7 1 1 64
NETWORK ANSI7 2 2 63	NETWORK1ANSI7 2 1 64
NETWORK ANSI7 5 5 62	NETWORK1ANSI7 1 2 64

C7ALWDPC

Table name

CCS7 Gateway STP Allowed Destination Point Codes Screening Table

Functional description

Table C7ALWDPC specifies screening functions for allowed destination point codes (DPC). Each screening function consists of a set of one or more screening rules. Each screening rule can have a different screening result.

Note: All references to signaling transfer point (STP) are applicable to the STP/Service Switching Point (SSP) Integrated Nodes (INode), unless otherwise specified.

For related information, refer to table C7GTWLKS.

Datafill sequence and implications

The following tables (if required) must be datafilled prior to table C7ALWDPC:

- C7BLKDPC
- C7CGPA
- C7DSTFLD

The following tables (if required) must be datafilled after table C7ALWDPC:

- C7ALWOPC
- C7ALWSIO
- C7BLKSIO (for network type CCITT7 only)
- C7BLKOPC
- C7GTWLKS

Table size

32 767 tuples

Up to 2000 tuples

Table size restrictions

The limit of 2000 tuples for this table depends on the datafill in the other gateway screening tables. There are a maximum of 2000 possible screening rules for all of the gateway tables (except table C7GTWLKS).

C7ALWDPC (continued)

- The limit of 32 767 tuples for this table depends on the datafill in the other gateway screening tables. There are a maximum of 32 767 possible screening rules for all of the gateway tables (except table C7GTWLKS) so the maximum number of tuples for the tables is 32 767 with the following restrictions:
- up to 1024 screening references for all tables
- up to 256 rules for each screening reference

Datafill

The following table lists datafill for table C7ALWDPC.

Field descriptions (Sheet 1 of 6)

Field	Subfield or refinement	Entry	Explanation and action
SCRNREF		see subfields	<i>Screening reference</i> This field is the key to the table and consists of subfields REFERENCE and RULENO.
	REFERENCE	alphanumeric (1 to 4 characters)	<i>Screening reference</i> Enter a value that uniquely identifies an allowed destination point code (DPC) screening function. This is the first part of a two-part key.
	RULENO	0 to 255	<i>Rule number</i> Enter a number to identify a rule in a screening function. Each screening function can consist of up to 256 distinct rules. This is the second part of a two-part key.
SCRNRULE		see subfields	<i>Screening rule</i> This field contains all of the screening rule information and consists of subfields NETTYPE, FROMPC, TOPC, PCRANGE and RESULT.
	NETTYPE	ANSI7, CCITT7, or NTC7	<i>Network type</i> Enter the network type of the screening rule. If the network type is ANSI7, the point codes being screened are in American National Standards Institute (ANSI) format. All screening functions defined prior to the BCS30 release of this table are ANSI7 format. Datafill refinements FROMPC, TOPC, and RESULT.

C7ALWDPC (continued)

Field descriptions (Sheet 2 of 6)

Field	Subfield or refinement	Entry	Explanation and action
			<p>If the network type is CCITT7, the screened point codes are in the CCITT format. Datafill refinements PCRRANGE and RESULT.</p> <p>If the network type is NTC7, the screened point codes are in the NTC7 format. Datafill refinements FROMPC, TOPC, and RESULT.</p> <p>Each rule of screening function must be of the same network type. The network type of a screening function cannot be changed.</p>
	PCRRANGE	see subfields	<i>CCITT point code range</i> If NETTYPE is CCITT7, datafill this refinement. It consists of subfields FORMAT, FROMPC and TOPC.
	FORMAT	INTL or BASIC	<i>Format of CCITT point codes</i> If entry in field NETTYPE is CCITT7, and the CCITT format required is international, enter INTL. If the format required is not international, enter BASIC.
	FROMPC	numeric	<i>From point code</i> If the entry in NETTYPE is CCITT7 and the entry in field FORMAT is INTL, enter a full DPC representing the start of the range of DPCs for this rule. This is specified as a multiple consisting of FROMZONE with a range of values from 0 to 7, FROMAREA with a range of values from 0 to 255 and FRMPPOINT with a range of values from 0 to 7.

C7ALWDPC (continued)

Field descriptions (Sheet 3 of 6)

Field	Subfield or refinement	Entry	Explanation and action
			<p>If the entry in NETTYPE is CCITT7 and the entry in field FORMAT is BASIC, enter a full DPC representing the start of the range of DPCs for this rule. The range of values that can be entered is from 0 to 16383.</p> <p>If the entry in NETTYPE is ANSI7, enter a full or partial DPC representing the start of the range of DPCs for this rule. This is specified as a vector of zero to three values in the range 0 to 255. End the vector with a blank column and a \$ (dollar sign).</p> <p>If the entry in NETTYPE is NTC7, enter a full DPC representing the start of the range of DPCs for this rule. The \$ (dollar sign) is not allowed.</p> <p>The value of subfield FROMPC must be less than or equal to the value in subfield TOPC.</p> <ul style="list-style-type: none"> • <i>Note:</i> The following additional restrictions are applied to each tuple only if they have the network type ANSI7 and if the Signaling, Engineering, and Administration System (SEAS) software is present in the STP: • The network identifier of fields FROMPC and TOPC must be in the range 1 to 255 (a value of 0 (zero) is not valid). • The point code range represented by fields FROMPC and TOPC can only be one of the following types of ranges: <ul style="list-style-type: none"> — a single point code — a range of, or all of, the point codes in a Network Cluster — a range of, or all of, the Network Clusters in a Network Identifier

C7ALWDPC (continued)

Field descriptions (Sheet 4 of 6)

Field	Subfield or refinement	Entry	Explanation and action
	TOPC	numeric	<p><i>To point code</i> the entry in NETTYPE is CCITT7 and the entry in field FORMAT is INTL, enter a full DPC representing the end of the range of DPCs for this rule. This is specified as a multiple consisting of TOZONE with a range of values from 0 to 7, TOAREA with a range of values from 0 to 255, and TOPOINT with a range of values from 0 to 7.</p> <p>If the entry in NETTYPE is CCITT7 and the entry in field FORMAT is BASIC, enter a full DPC representing the end of the range of DPCs for this rule. The range of values that can be entered is from 0 to 16 383.</p> <p>If the entry in NETTYPE is ANSI7, enter a full or partial DPC representing the end of the range of DPCs for this rule. This is specified as a vector of zero to three values in the range 0 to 255. End the vector with a blank column and a \$.</p> <p>If the entry in NETTYPE is NTC7, enter a full DPC representing the end of the range of DPCs for this rule. The \$ (dollar sign) is not allowed.</p> <p>The value of subfield TOPC must be greater than or equal to the value in subfield FROMPC.</p>

C7ALWDPC (continued)

Field descriptions (Sheet 5 of 6)

Field	Subfield or refinement	Entry	Explanation and action
			<ul style="list-style-type: none"> <i>Note:</i> The following additional restrictions are applied to each tuple only if they have the network type ANSI7 and if the Signaling, Engineering, and Administration System (SEAS) software is present in the STP: The Network Identifier of the FROMPC and TOPC fields must be in the range 1 to 255 (a value of 0 (zero) is not valid). The point code range represented by the FROMPC and TOPC fields can only be one of the following types of ranges: <ul style="list-style-type: none"> — a single point code — a range of, or all of, the point codes in a Network Cluster — a range of, or all of, the Network Clusters in a Network Identifier
	RESULT	see subfields	<i>Screening result</i> This two-part field specifies the next screening function to be invoked for messages that follow this rule. This field consists of subfield NEXTFN.
	NEXTFN	C7BLKDPC C7CGPA C7DSTFLD STOP	<p><i>Next screening function</i>Enter the next screening function to be performed.</p> <p>If the entry is STOP, no refinements require datafill.</p> <p>If the entry is other than STOP, datafill refinement NEXTREF.</p> <p>If the network type is CCITT7, an entry of C7CGPA is not permitted.</p>
	NEXTREF	alphanumeric (up to 4 characters)	<i>Next screening reference</i> If the entry in field NEXTFN is other than STOP, enter the value in field REFERENCE of the screening table specified in field NEXTFN, to designate the next screening function to be performed.

C7ALWDPC (continued)**Field descriptions (Sheet 6 of 6)**

Field	Subfield or refinement	Entry	Explanation and action
REMARKS		alphanumeric (1 to 8 characters)	<i>Remarks</i> This field is specified by the operating company. It can be used to identify the network or carrier to which the link is connected. Any eight-character value can be stored in this field. Avoid the use of special characters, such as +, *, /, -, and %.
OPTIONS		see subfields	<i>Options</i> This field is used to specify CCS7 screening options. It consists of subfield OPTNAME.
	OPTNAME	\$	<i>Option name</i> Enter \$, which is the only valid entry.

Datafill example

The following example shows sample datafill for table C7ALWDPC.

If none of the screening rules match the message being screened, the message is discarded.

C7ALWDPC (continued)**MAP display example for table C7ALWDPC**

SCRNREF											SCRNRULE	REMARKS	
OPTIONS													
REF4	0	ANSI7	(1)	(1)	(1)	\$	(1)	(1)	(1)	\$	C7BLKDPC	REF5	\$
						\$							\$
REF4	1	ANSI7	(1)	(1)	(2)	\$	(1)	(1)	(2)	\$	C7BLKDPC	REF5	\$
						\$							\$
REF4	2	ANSI7	(1)	(1)	(3)	\$	(1)	(1)	(3)	\$	C7BLKDPC	REF5	\$
						\$							\$
REF4	3	ANSI7	(1)	(1)	(4)	\$	(1)	(1)	(4)	\$	C7BLKDPC	REF5	\$
						\$							\$
REF4	4	ANSI7	(1)	(1)	(5)	\$	(1)	(1)	(5)	\$	C7BLKDPC	REF5	\$
						\$							\$

Table history**STP04.0**

Removed references to MDR7 screening.

CSP06

Information removed about bulk deletion workaround.

CSP02

Information added about the possibility of service degradation if gateway screening is not turned off.

BCS36

Information added about bulk deletions.

Supplementary information

This section provides information on datafilling table C7ALWDPC for specific applications.

C7ALWDPC (end)

Datafill modifications



DANGER

Risk of service degradation

A service degradation can occur if gateway screening is not turned off in table C7GTWLKS prior to making additions, deletions, or changes to table C7ALWDPC.

The table control warning is displayed at the MAP display if a user attempts to add, change, or delete tuples in table C7ALWDPC.

A similar message is displayed in all the gateway screening tables (C7AFTPC, C7ALWDPC, C7ALWGTT, C7ALWOPC, C7ALWSIO, C7BLKDPC, C7BLKOPC, C7BLKSIO for CCITT only, C7CDPA, C7CGPA, and C7DSTFLD).

Note: The VERIFY function must be turned on. If VERIFY is off, the above warning is not displayed.

C7ALWGTT

Table name

CCS7 Gateway STP SCCP Allowed Global Title Translation Screening Table

Functional description

Table C7ALWGTT defines the gateway screening functions for the allowed signaling connection control part (SCCP) global title translation (GTT) types.

Note: All references to signaling transfer point (STP) are also applicable to STP/Service Switching Point (SSP) Integrated Nodes (INode), unless otherwise specified.

For related information, refer to table C7GTWLKS.

Datafill sequence and implications

The following table (if required) must be datafilled before table C7ALWGTT.

- C7CDPA

The following tables (if required) must be datafilled after table C7ALWGTT:

- C7CGPA

Table size

0 to 32 767 tuples

Up to 2000 tuples

The limit of 2000 tuples for this table depends on the datafill in the other gateway screening tables. There are a maximum of 2000 possible screening rules for all of the gateway tables (except table C7GTWLKS).

- The following restrictions apply:
- up to 1024 screening references are allowed for all tables
- up to 256 rules are allowed for each screening reference

C7ALWGTT (continued)**Datafill**

The following table lists datafill for table C7ALWGTT.

Field descriptions (Sheet 1 of 2)

Field	Subfield or refinement	Entry	Explanation and action
SCRNREF		see subfields	<i>Screening reference</i> This field is the key to the table and consists of subfields REFERNCE and RULENO.
	REFERNCE	alphanumeric (1 to 4 characters)	<i>Screening reference</i> Enter a value that uniquely identifies a global title translation (GTT) screening function.
	RULENO	0 to 255	<i>Rule number</i> Enter a number to identify a rule in a screening function. Each screening function consists of up to 256 distinct rules.
SCRNRULE		see subfields	<i>Screening rule</i> This field contains all the screening rule information and consists of subfields NETTYPE, FROMTT, TOTTT, and RESULT.
	NETTYPE	ANSI7, CCITT7, or NTC7	<i>Network type</i> Enter the network type of the screening rule.
	FROMTT	0 to 255	<i>From global title translation number</i> Enter one of the GTT numbers representing the start of the range of GTT numbers to which this rule applies. The value in subfield FROMTT must be less than or equal to the value in subfield TOTTT.
	TOTTT	0 to 255	<i>To global title translation number</i> Enter one of the GTT numbers representing the end of the range of GTT numbers to which this rule applies. The value in subfield TOTTT must be greater than or equal to the value in subfield FROMTT.
	RESULT	see refinements	<i>Screening result</i> This subfield specifies the next screening function invoked and consists of subfield NEXTFN.

C7ALWGTT (continued)**Field descriptions (Sheet 2 of 2)**

Field	Subfield or refinement	Entry	Explanation and action
REMARKS	NEXTFN	C7CDPA or STOP	<p><i>Next screening function</i> Enter the next screening function to be performed.</p> <p>If subfield NETTYPE contains CCITT7, STOP is the only valid entry.</p> <p>Enter STOP to stop the screening function. No additional refinements require datafill.</p> <p>Enter C7CDPA for table C7CDPA and datafill refinement NEXTREF.</p>
	NEXTREF	alphanumeric (1 to 4 characters)	<p><i>Next screening reference</i> If subfield NEXTFN contains C7CDPA, enter the value in field REFERENCE of table C7CDPA that designates the next screening function to be performed.</p>
		alphanumeric (1 to 8 characters)	<p><i>Remarks</i> Use this field to identify the name of the network or carrier to which the link is connected. Any eight-character value can be stored in this field. Avoid the use of special characters, such as +, *, /, -, and %.</p>
	OPTIONS	see subfields	<p><i>Options</i> This field is used to specify Common Channel Signaling 7 (CCS7) screening options. This field consists of subfield OPTNAME.</p>
	OPTNAME	\$	<p><i>Option name</i> Enter \$, which is the only valid entry.</p>

Datafill example

The following example shows sample datafill for table C7ALWGTT.

C7ALWGTT (continued)**MAP display example for table C7ALWGTT**

SCRNREF	SCRNREF	SCRNREF	SCRNREF	SCRNREF	SCRNREF	SCRNREF	SCRNREF	REMARKS
OPTIONS								
REF7	0	ANSI7	(251)\$	(251)\$	C7CDPA	REF8		\$
\$								
REF7	1	ANSI7	(2)\$	(2)\$	C7CDPA	REF8		\$
\$								
REF7	2	ANSI7	(3)\$	(3)\$	C7CDPA	REF8		\$
\$								
REF7	3	ANSI7	(4)\$	(4)\$	C7CDPA	REF8		\$
\$								
REF7	4	ANSI7	(5)\$	(5)\$	C7CDPA	REF8		\$
\$								

Table history**STP04.0**

Removed references to MDR7 screening.

CSP06

Information removed about bulk deletion workaround.

CSP02

Information added about service degradation possibility if gateway screening is not turned off.

BCS36

Refinement MAXOCTET removed. Information added about bulk deletions.

Supplementary information

This section provides information on modifying datafill in table C7ALWGTT.

Datafill modifications**DANGER****Risk of service degradation**

A service degradation can occur if gateway screening is not turned off in table C7GTWLKS prior to making additions, deletions, or changes to table C7ALWGTT.

The table control warning is displayed at the MAP display if a user attempts to add, change, or delete tuples in table C7ALWGTT.

A similar message is displayed in all the gateway screening tables (C7AFTPC, C7ALWDPC, C7ALWGTT, C7ALWOPC, C7ALWSIO, C7BLKDPC, C7BLKOPC, C7BLKSIO for CCITT only, C7CDPA, C7CGPA, and C7DSTFLD).

Note: The VERIFY function must be turned on. If VERIFY is off, the above warning is not displayed.

C7ALWOPC

Table name

CCS7 Gateway STP Allowed Originating Point Codes Screening Table

Functional description

Table C7ALWOPC is used to specify screening functions for allowed originating point codes (OPCs). Each screening function consists of a set of one or more screening rules. Each screening rule may have a different screening result.

Note: All references to signaling transfer point (STP) are applicable to the STP/Service Switching Point (SSP) Integrated Nodes (INode), unless otherwise specified.

For related information, refer to table C7GTWLKS.

Datafill sequence and implications

The following tables (if required) must be datafilled before table C7ALWOPC:

- C7ALWDPC
- C7ALWSIO
- C7BLKDPC
- C7BLKOPC
- C7BLKSIO (for network type = CCITT7 only)
- C7CGPA
- C7DSTFLD

The following table (if required) must be datafilled after table C7ALWOPC:

- C7GTWLKS

Table size

32 767 tuples

Up to 2000 tuples

The limit of 2000 tuples for this table depends on the datafill in the other gateway screening tables. There are a maximum of 2000 possible screening rules for all of the gateway tables (except table C7GTWLKS).

C7ALWOPC (continued)

- The limit of 32 767 tuples for this table depends on the datafill in the other gateway screening tables. There are a maximum of 32 767 possible screening rules for all of the gateway tables (except table C7GTWLKS). Therefore, the maximum number of tuples for the tables is 32 767 with the following restrictions:
- up to 1024 screening references for all tables
- up to 256 rules for each screening reference

Datafill

The following table lists datafill for table C7ALWOPC.

Field descriptions (Sheet 1 of 2)

Field	Subfield or refinement	Entry	Explanation and action
SCRNREF		see subfields	<i>Screening reference</i> This field is the key to the table and consists of subfields REFERNCE and RULENO.
	REFERNCE	alphanumeric (1 to 4 characters)	<i>Screening reference</i> Enter a value that identifies an allowed originating point code (OPC) screening function.
	RULENO	0 to 255	<i>Rule number</i> Enter a number to identify a rule in a screening function. Each screening function may consist of up to 256 distinct rules.
SCRNRULE		see subfields	<i>Screening rule</i> This field contains all the screening rule information and consists of subfields NETTYPE, FROMPC, TOPC, PCRANGE, and RESULT.

C7ALWOPC (continued)

Field descriptions (Sheet 2 of 2)

Field	Subfield or refinement	Entry	Explanation and action
	NETTYPE	ANSI7,CCITT 7, or NTC7	<p><i>Network type</i> Enter the network type of the screening rule.</p> <p>Enter ANSI7 if the screened point codes are in ANSI format. Datafill refinements FROMPC, TOPC, and RESULT described in the table in the following section.</p> <p>Enter CCITT7 if the screened point codes are in the CCITT format. Datafill refinements PCRANGE and RESULT described in the table in the following section.</p> <p>Enter NTC7 if the screened point codes are in NTC7 format. Datafill refinements FROMPC, TOPC, and RESULT described in the table in the following section..</p> <p>Note: All screening functions that were defined prior to the BCS30 release of this table are ANSI format.</p>

NETTYPE = ANSI7 and NTC7

If the entry in subfield NETTYPE is ANSI7 or NTC7, datafill refinements FROMPC, TOPC as described in the following table, then datafill refinement RESULT described in Table “Field descriptions” in section “NETTYPE = ANSI7, CCITT7, and NTC7”.

C7ALWOPC (continued)**Field descriptions for conditional datafill (Sheet 1 of 2)**

Field	Subfield or refinement	Entry	Explanation and action
	FROMPC	0 to 255	<p><i>From point code</i> the NETTYPE is ANSI7, enter a full or partial OPC representing the start of the range of OPCs to which this rule applies. Up to three values can be datafilled. If less than three values are required, end the list with a \$.</p> <p>If the NETTYPE is NTC7, enter a full OPC representing the start of the range of OPCs to which this rule applies. The \$ (dollar sign) is not allowed.</p> <p>The value of field FROMPC must be less than or equal to the value in field TOPC.</p> <ul style="list-style-type: none"> • <i>Note:</i> The following additional restrictions are applied to each tuple only if they have the network type ANSI7 and if the Signaling, Engineering, and Administration System (SEAS) software is present in the STP: <ul style="list-style-type: none"> • The network identifier of fields FROMPC and TOPC must be in the range 1 to 255 (a value of 0 (zero) is not valid). • The point code range represented by fields FROMPC and TOPC can only be one of the following types of ranges: <ul style="list-style-type: none"> — a single point code — a range of, or all of, the point codes in a network cluster — a range of, or all of, the network clusters in a network identifier — a range of, or all of, the network identifiers in the entire range of point codes

C7ALWOPC (continued)

Field descriptions for conditional datafill (Sheet 2 of 2)

Field	Subfield or refinement	Entry	Explanation and action
	TOPC	0 to 255	<p><i>To point code</i> If the NETTYPE is ANSI7, enter a full or partial OPC representing the end of the range of OPCs to which this rule applies. Up to three values can be datafilled. If less than three values are required, end the list with a blank column and a \$.</p> <p>If the NETTYPE is NTC7, enter a full OPC representing the end of the range of OPCs to which this rule applies. The \$ (dollar sign) is not allowed.</p> <p>The value of field TOPC must be greater than or equal to the value in field FROMPC.</p> <ul style="list-style-type: none"> • <i>Note:</i> The following additional restrictions are applied to each tuple only if they have the network type ANSI7 and if the Signaling, Engineering, and Administration System (SEAS) software is present in the STP: <ul style="list-style-type: none"> • The network identifier of fields FROMPC and TOPC must be in the range 1 to 255 (a value of 0 (zero) is not valid). • The point code range represented by fields FROMPC and TOPC can only be one of the following types of ranges: <ul style="list-style-type: none"> — a single point code — a range of, or all of, the point codes in a network cluster — a range of, or all of, the network clusters in a network identifier — a range of, or all of, the network identifiers in the entire range of point codes

NETTYPE = CCITT7

If the entry in subfield NETTYPE is CCITT7, datafill refinement PCRANGE and its refinements as described in the following table, then datafill field RESULT described in Table “Field descriptions” in section “NETTYPE = ANSI7, CCITT7, and NTC7”.

C7ALWOPC (continued)**Field descriptions for conditional datafill (Sheet 1 of 2)**

Field	Subfield or refinement	Entry	Explanation and action
TOPC	PCRANGE	see subfield	<i>CCITT point code range</i> This field consists of subfield FORMAT.
	FORMAT	BASICorINTL	<i>Format of CCITT point codes</i> For international format, enter INTL. For non-international format, enter BASIC.
	FROMPC	0 to 16383 or see subfields	<i>From point code</i> If the entry in subfield FORMAT is BASIC, enter a full OPC representing the start of the range of OPCs to which this rule applies. If the entry in subfield FORMAT is INTL, this field consists of subfields FROMZONE, FROMAREA, and FRMPOINT. Separate each subfield with a single space. The value of field FROMPC must be less than or equal to the value in field TOPC.
	FROMZONE	0 to 7	<i>From zone</i> Enter a value in the field FROMZONE for the OPC to which this rule applies.
	FROMAREA	0 to 255	<i>From area</i> Enter a value in the field FROMAREA for the OPC to which this rule applies.
	FRMPOINT	0 to 7	<i>From point</i> Enter a value in the field FRMPOINT for the OPC to which this rule applies.
			0 to 16 383 or see subfields

C7ALWOPC (continued)

Field descriptions for conditional datafill (Sheet 2 of 2)

Field	Subfield or refinement	Entry	Explanation and action
	TOZONE	0 to 7	<i>To zone</i> Enter a value in the field TOZONE for the OPC to which this rule applies.
	TOAREA	0 to 255	<i>To area</i> Enter a value in the field TOAREA for the OPC to which this rule applies.
	TOPOINT	0 to 7	<i>To point</i> Enter a value in the field TOPOINT for the OPC to which this rule applies.

NETTYPE = ANSI7, CCITT7, and NTC7

For all network types, continue datafill with refinement RESULT as described in the following table.

Field descriptions (Sheet 1 of 2)

Field	Subfield or refinement	Entry	Explanation and action
	RESULT	see subfields	<i>Screening result</i> This two-part field specifies the next screening function invoked for messages that follow this rule. This field consists of subfields NEXTFN and NEXTREF.
	NEXTFN	C7ALWDPCC 7ALWSIOC7 BLKDPCC7B LKOPCC7BL KSIOC7CGP AC7DSTFLD or STOP	<i>Next screening function</i> Enter the next screening function performed. Enter STOP to stop the screening function. No refinements require datafill. Note: If the network type is CCITT7, an entry of C7CGPA is not permitted. Note: If the network type is ANSI7 or NTC7, an entry of C7BLKSIO is not permitted. For all entries other than STOP, datafill refinement NEXTREF.
	NEXTREF	alphanumeric (up to 4 characters)	<i>Next screening reference</i> If the entry in subfield NEXTFN is other than STOP, enter the value in field REFERENCE of the screening table, specified in field NEXTFN, that designates the next screening function performed.

C7ALWOPC (continued)**Field descriptions (Sheet 2 of 2)**

Field	Subfield or refinement	Entry	Explanation and action
REMARKS		alphanumeric (1 to 8 characters)	<i>Remarks</i> This field is specified by the operating company and may be used to identify the name of the network or carrier to which the link is connected. Any eight character value may be stored in this field. Avoid the use of special characters, such as +, *, /, -, and %.
OPTIONS		see subfields	<i>Options</i> This field is used to specify CCS7 screening options. It consists of subfield OPTNAME.
	OPTNAME	\$	<i>Option name</i> Enter \$, which is the only valid entry.

Datafill example

The following example shows sample datafill for table C7ALWOPC.

If none of the screening rules match the message being screened, the message is discarded.

C7ALWOPC (continued)

MAP display example for table C7ALWOPC

SCRNREF	OPTIONS	SCRNRULE	REMARKS
REF0	0 ANSI7 (1) (1) (1)\$ (1) (1) (1)\$	STOP	\$
	\$		
REF0	1 ANSI7 (3) (3) (3)\$ (3) (3) (3)\$	STOP	\$
	\$		
REF1	0 ANSI7 (0) (1) (1)\$ (0) (1) (1)\$	C7BLKOPC REF2	\$
	\$		
REF1	1 ANSI7 (1) (1) (2)\$ (1) (1) (2)\$	C7BLKOPC REF2	\$
	\$		
REF1	2 ANSI7 (1) (1) (3)\$ (1) (1) (3)\$	C7BLKOPC REF2	\$
	\$		

Table history

STP04.0

Removed references to MDR7 screening.

CSP06

Removed information about bulk deletion workaround.

CSP02

Information added about the possibility of service degradation if gateway screening is not turned off.

BCS36

Refinement MAXOCTETS removed. Information added about bulk deletions.

Supplementary information

This section provides information on modifying datafill in table C7ALWOPC.

C7ALWOPC (end)

Datafill modifications**DANGER****Risk of service degradation**

A service degradation can occur if gateway screening is not turned off in table C7GTWLKS prior to making additions, deletions, or changes to table C7ALWOPC.

The control warning is displayed at the MAP display if a user attempts to add, change, or delete tuples in table C7ALWOPC.

A similar message is displayed in all the gateway screening tables (C7AFTPC, C7ALWDPC, C7ALWGTT, C7ALWOPC, C7ALWSIO, C7BLKDPC, C7BLKOPC, C7BLKSIO for CCITT only, C7CDPA, C7CGPA, and C7DSTFLD).

Note: The VERIFY function must be turned on. If VERIFY is off, the above warning is not displayed.

C7ALWSIO

Table name

CCS7 Gateway STP Allowed Service Information Octets Screening Table

Functional description

Table C7ALWSIO is used to specify screening functions for allowed service information octets (SIO). Each screening function consists of a set of one or more screening rules. Each screening rule can have a different screening result.

Note: All references to signaling transfer point (STP) are applicable to STP/Service Switching Point (SSP) Integrated Nodes (INode), unless otherwise specified.

For related information, refer to table C7GTWLKS.

Datafill sequence and implications

The following tables (if required) must be datafilled before table C7ALWSIO:

- C7ALWDPC
- C7BLKDPC
- C7CDPA
- C7CGPA
- C7DSTFLD

The following tables (if required) must be datafilled after table C7ALWSIO:

- C7ALWOPC
- C7BLKOPC
- C7GTWLKS

Table size

32 767

Up to 2000 tuples for American National Standards Institute (ANSI) network type.

Up to 200 tuples for International Telecommunication Union (ITU), formerly International Telegraph and Telephone Consultative Committee (CCITT), network type.

C7ALWSIO (continued)**Table size restrictions**

The limit of 2000 tuples for this table depends on the datafill in the other gateway screening tables. There is a maximum of 2000 possible screening rules for all of the gateway tables (except C7GTWLKS).

The limit of 32 767 tuples for this table depends on the datafill in the other gateway screening tables. There are a maximum of 32 767 possible screening rules for all of the gateway tables (except C7GTWLKS) so the maximum number of tuples for the tables is 32 767 with the following restrictions:

- up to 1024 screening references for all tables
- up to 256 rules for each screening reference

Datafill

The following table lists datafill for table C7ALWSIO.

Field descriptions (Sheet 1 of 7)

Field	Subfield or refinement	Entry	Explanation and action
SCRNREF		see subfields	<i>Screening reference</i> This field is the key to the table and consists of subfields REFERNCE and RULENO.
	REFERNCE	alphanumeric (1 to 4 characters)	<i>Screening reference</i> Enter a value that uniquely identifies an allowed service information octet (SIO) screening function. This is the first part of a two-part key.
	RULENO	0 to 255	<i>Rule number</i> Enter a number to identify a rule in a screening function. Each screening function can consist of up to 256 distinct rules. This is the second part of a two-part key.
SCRNRULE		see subfield	<i>Screening rule</i> This field contains all of the screening rule information and consists of subfield NETTYPE and its refinements.

C7ALWSIO (continued)

Field descriptions (Sheet 2 of 7)

Field	Subfield or refinement	Entry	Explanation and action
	NETTYPE	ANSI7,CCITT 7, or NTC7	<p><i>Network type</i> Enter the network type of the screening rule.</p> <p>If the network type is ANSI7, the screened point codes are in ANSI format. All screening functions defined prior to the BCS30 release of this table are of this type. Datafill refinements FROMSI, TOSI, FROMNI, TONI, FROMPRI, TOPRI, FROMH0, TOH0, FROMH1, TOH1, and RESULT.</p> <p>If the network type is CCITT7, the screened point codes are in the CCITT format. Datafill refinements FROMSI, TOSI, FROMH0, TOH0, FROMH1, TOH1, and RESULT.</p> <p>If the network type is NTC7, the screened point codes are in NTC7 format. Datafill refinements FROMSI, TOSI, FROMNI, TONI, FROMH0, TOH0, FROMH1, TOH1, and RESULT.</p>
	FROMSI	0 to 15 or \$	<p><i>From service indicators</i> Enter one of the service indicators representing the start of the range of service indicators to which this rule applies.</p> <p>The value in refinement FROMSI must be less than the value in refinement TOSI.</p> <p>If the rule includes all service indicators, enter \$, in refinements FROMSI and TOSI.</p>
	TOSI	0 to 15 or \$	<p><i>To service indicators</i> Enter one of the service indicators representing the end of the range of service indicators to which this rule applies.</p> <p>The value in refinement TOSI must be greater than the value in refinement FROMSI.</p> <p>If the rule includes all service indicators, enter \$, in refinements FROMSI and TOSI.</p>

C7ALWSIO (continued)

Field descriptions (Sheet 3 of 7)

Field	Subfield or refinement	Entry	Explanation and action
	FROMNI	0 to 3 or \$	<p><i>From network indicator</i>If the entry in field NETTYPE is ANSI7 or NTC7, enter one of the network indicators representing the start of the range of network indicators to which this rule applies.</p> <p>The value in refinement FROMNI must be less than the value in refinement TONI.</p> <p>The network indicators are defined as follows:</p> <ul style="list-style-type: none"> • 0 = INTL (international) • 1 = INTL spare (international spare) • 2 = NATL (national) • 3 = NATL spare (national spare) <p>If the rule includes all network indicators, enter \$, in refinements FROMNI and TONI.</p>
	TONI	0 to 3 or \$	<p><i>To network indicator</i>If the entry in field NETTYPE is ANSI7 or NTC7, enter one of the network indicators representing the end of the range of network indicators to which this rule applies.</p> <p>The value in refinement TONI must be greater than the value in refinement FROMNI.</p> <p>The network indicators are as follows:</p> <ul style="list-style-type: none"> • 0 = INTL (international) • 1 = INTL spare (international spare) • 2 = NATL (national) • 3 = NATL spare (national spare) <p>If the rule includes all network indicators, enter \$, in refinements FROMNI and TONI.</p> <p>If the entry in field NETTYPE is CCITT7, leave this refinement blank.</p>

C7ALWSIO (continued)

Field descriptions (Sheet 4 of 7)

Field	Subfield or refinement	Entry	Explanation and action
	FROMPRI	0 to 3 or \$	<p><i>From priority values</i>If the entry in field NETTYPE is ANSI7, enter one of the priority values representing the start of the range of priority values to which this rule applies.</p> <p>The value in refinement FROMPRI must be less than the value in refinement TOPRI.</p> <p>If the rule includes all priority values, enter \$, in refinements FROMPRI and TOPRI.</p> <p>If the entry in field NETTYPE is CCITT7 or NTC7, leave this refinement blank.</p>
	TOPRI	0 to 3 or \$	<p><i>To priority values</i>If the entry in field NETTYPE is ANSI7, enter one of the priority values representing the end of the range of priority values to which this rule applies.</p> <p>The value in refinement TOPRI must be greater than the value in refinement FROMPRI.</p> <p>If the rule includes all priority values, enter \$, in refinements FROMPRI and TOPRI.</p> <p>If the entry in field NETTYPE is CCITT7 or NTC7, leave this refinement blank.</p>
	FROMH0	0 to 15 or \$	<p><i>From H0</i>Enter one of the values of the H0 code representing the start of the range of H0 codes to which this rule applies.</p> <p>The value of refinement FROMH0 must be less than the value in refinement TOH0. These fields are only significant when the service indicator of the message is equal to 0, 1, 2, or 4.</p> <p>For a NETTYPE of ANSI7, these fields are only significant when the service indicator is equal to 0, 1, or 2.</p> <p>For a NETTYPE of NTC7 or CCITT, these fields are significant when the service indicator is equal to 0, 1, 2, or 4.</p> <p>If the rule includes all values of the H0 code, enter \$, in refinements FROMH0 and TOH0.</p>

C7ALWSIO (continued)

Field descriptions (Sheet 5 of 7)

Field	Subfield or refinement	Entry	Explanation and action
	TOH0	0 to 15 or \$	<p><i>To H0</i> Enter one of the values of the H0 code representing the end of the range of H0 codes to which this rule applies.</p> <p>The value in refinement TOH0 is significant when the service indicator of the message is equal to 0, 1, 2, or 4.</p> <p>For a NETTYPE of ANSI7, these fields are only significant when the service indicator is equal to 0, 1, or 2.</p> <p>For a NETTYPE of NTC7 or CCITT7, these fields are only significant when the service indicator is equal to 0, 1, 2, or 4.</p> <p>If the rule includes all values of the H0 code, enter \$, in refinements FROMH0 and TOH0.</p> <p>Note: The H0 heading code field must be NIL, if the service indicator field is not equal to zero.</p>
	FROMH1	0 to 15 or \$	<p><i>From H1</i> Enter one of the values of the H1 code representing the start of the range of H1 codes to which this rule applies.</p> <p>The value in refinement FROMH1 must be less than the value in refinement TOH1. These fields are only significant if the service indicator of the message is equal to 0, 1, 2, or 4.</p> <p>For a NETTYPE of ANSI7, these fields are only significant when the service indicator is equal to 0, 1, or 2.</p> <p>For a NETTYPE of NTC7 or CCITT7, these fields are only significant when the service indicator is equal to 0, 1, 2, or 4.</p> <p>If the rule includes all values of the H1 code, enter \$, in refinements FROMH0 and TOH1.</p>

C7ALWSIO (continued)

Field descriptions (Sheet 6 of 7)

Field	Subfield or refinement	Entry	Explanation and action
	TOH1	0 to 15 or \$	<p><i>To H1</i> Enter one of the values of the H1 code representing the end of the range of H1 codes to which this rule applies.</p> <p>The value in refinement TOH1 must be greater than the value in refinement FROMH1. These fields are only significant if the service indicator of the message is equal to 0, 1, 2, or 4.</p> <p>For a NETTYPE of ANSI7, these fields are only significant when the service indicator is equal to 0, 1, or 2.</p> <p>For a NETTYPE of NTC7 or CCITT7, these fields are only significant when the service indicator is equal to 0, 1, 2, or 4.</p> <p>Where the rule includes all values of the H1 Code, enter \$, in refinements FROMH1 and TOH1.</p> <p>Note: The H1 heading code field must be NIL, if the service indicator field is not equal to zero. The H1 heading code field must not be NIL, if the H0 heading code field is not NIL.</p>
	RESULT	see subfield	<p><i>Screening result</i> This two-part field specifies the next screening function to be invoked for messages that follow this rule. This refinement consists of subfield NEXTFN.</p>

C7ALWSIO (continued)

Field descriptions (Sheet 7 of 7)

Field	Subfield or refinement	Entry	Explanation and action
	NEXTFN	C7ALWDPC C7BLKDPC C7CDPA C7CGPAC7B LKSIOC7DST FLD STOP	<p><i>Next screening function</i> Enter the next screening function to be performed.</p> <p>If the entry is STOP, no refinements require datafill.</p> <p>If the entry is other than STOP, datafill refinement NEXTREF.</p> <p>If the network type is CCITT7, an entry of C7CDPA is not permitted.</p> <p>If the network type is ANSI7, an entry of C7BLKSIO is not permitted.</p> <p>If the network type is ANSI7 or NTC7, an entry of C7BLKSIO is not permitted.</p> <ul style="list-style-type: none"> • <i>Note:</i> The next screening function field cannot be C7CDPA or C7CGPA if the following conditions apply: • the H0 heading code field and the H1 heading code field are both not NIL, or • the service indicator field is not equal to 3.
	NEXTREF	alphanumeric (up to 4 characters)	<i>Next screening reference</i> If the entry in field NEXTFN is other than STOP, enter the value in subfield REFERENCE of the screening table, specified in field NEXTFN, that designates the next screening function to be performed.
REMARKS		alphanumeric (1 to 8 characters)	<i>Remarks</i> This field is specified by the operating company and can be used to identify the name of the network or carrier to which the link is connected. Any eight-character value can be stored in this field. Avoid the use of special characters, such as +, *, /, -, and %
OPTIONS		see subfields	<i>Options</i> This field is used to specify CCS7 screening options. It consists of subfield OPTNAME.
	OPTNAME	\$	<i>Option name</i> Enter \$, which is the only valid entry.

C7ALWSIO (continued)

Datafill example

The following example shows sample datafill for table C7ALWSIO.

If none of the screening rules match the message being screened, the message is discarded.

MAP display example for table C7ALWSIO

SCRNREF	SCRNRULE
OPTIONS	REMARKS
REF3 0 ANSI7 (0)\$ (0)\$ 0 3 0 3 (0)\$ (0)\$ (0)\$ (0)\$	C7ALWDPC REF4 \$
\$	
REF3 1 ANSI7 (0)\$ (0)\$ 0 3 0 3 (0)\$ (0)\$ (1)\$ (1)\$	C7ALWDPC REF4 \$
\$	
REF3 2 ANSI7 (0)\$ (0)\$ 0 3 0 3 (0)\$ (0)\$ (2)\$ (2)\$	C7ALWDPC REF4 \$
\$	
REF3 3 ANSI7 (0)\$ (0)\$ 0 3 0 3 (0)\$ (0)\$ (3)\$ (3)\$	C7ALWDPC REF4 \$
\$	
REF3 4 ANSI7 (0)\$ (0)\$ 0 3 0 3 (0)\$ (0)\$ (4)\$ (4)\$	C7ALWDPC REF4 \$
\$	

Table history

STP04.0

Removed references to MDR7 screening.

CSP06

Information removed about bulk deletion workaround.

CSP02

Information added about the possibility of service degradation if gateway screening is not turned off.

BCS36

Information added about bulk deletions.

Supplementary information

This section provides information on modifying datafill in table C7ALWSIO.

Datafill modifications

**DANGER****Risk of service degradation**

A service degradation can occur if gateway screening is not turned off in table C7GTWLKS prior to making additions, deletions, or changes to table C7ALWSIO.

The table control warning is displayed at the MAP display if a user attempts to add, change, or delete tuples in table C7ALWSIO.

A similar message is displayed in all the gateway screening tables (C7AFTPC, C7ALWDPC, C7ALWGTT, C7ALWOPC, C7ALWSIO, C7BLKDPC, C7BLKOPC, C7BLKSIO for CCITT only, C7CDPA, C7CGPA, and C7DSTFLD).

Note: The VERIFY function must be turned on. If VERIFY is off, the above warning is not displayed.

C7BLKDPC

Table name

CCS7 Gateway STP Blocked Destination Point Codes Screening Table

Functional description

Table C7BLKDPC specifies screening functions for blocked destination point codes (DPC). Each screening function consists of a set of one or more screening rules. For each screening reference, the default rule must be the first specified rule. Each screening rule can have a different screening result.

Note: All references to signaling transfer point (STP) are also applicable to STP/Service Switching Point (SSP) Integrated Nodes (INode), unless otherwise specified.

For related information, refer to table C7GTWLKS.

Datafill sequence and implications

The following tables (if required) must be datafilled before table C7BLKDPC.

- C7CGPA (network type ANSI7 only)
- C7DSTFLD

The following tables (if required) must be datafilled after table C7BLKDPC:

- C7ALWDPC
- C7ALWOPC
- C7ALWSIO
- C7BLKSIO (for network type CCITT7 only)
- C7BLKOPC
- C7GTWLKS

Table size

32 767

Up to 2000 tuples

The limit of 2000 tuples for this table depends on the datafill in the other gateway screening tables. There are a maximum of 2000 possible screening rules for all of the gateway tables (except table C7GTWLKS).

C7BLKDPC (continued)

The limit of 32 767 tuples for this table depends on the datafill in the other gateway screening tables. There are a maximum of 32 767 possible screening rules for all of the gateway tables (except table C7GTWLKS), therefore the maximum number of tuples for the tables is 32 767 with the following restrictions:

- up to 1024 screening references for all tables
- up to 256 rules for each screening reference

Datafill

The following table lists datafill for table C7BLKDPC.

Field descriptions (Sheet 1 of 2)

Field	Subfield or refinement	Entry	Explanation and action
SCRNREF		see subfields	<i>Screening reference</i> This field is the key to the table and consists of subfields REFERNCE and RULENO.
	REFERNCE	alphanumeric (1 to 4 characters)	<i>Screening reference</i> Enter a value that identifies a blocked destination point code (DPC) screening function.
	RULENO	0 to 255	<i>Rule number</i> Enter a number to identify a rule in a screening function. Each screening function can consist of up to 256 distinct rules. A value of 0 must be used if subfield RULETYPE has a value of DEFAULT.

C7BLKDPC (continued)

Field descriptions (Sheet 2 of 2)

Field	Subfield or refinement	Entry	Explanation and action
SCRNRULE		see subfields	<i>Rule type</i> This field contains all of the screening rule information and consists of subfield NETTYPE.
	NETTYPE	ANSI7, CCITT7, or NTC7	<p><i>Network type</i>Enter the network type of the screening rule.</p> <p>Enter ANSI7 if the screened point codes are in the ANSI format and datafill refinement RULE as described in Table "Field descriptions for conditional datafill" on the next page..</p> <p>Enter CCITT7 if the screened point codes are in the CCITT7 format and datafill refinement RULE as described in Table "Field descriptions for conditional datafill" in section "NETTYPE = CCITT7".</p> <p>Enter NTC7 if the screened point codes are in the NTC7 format and datafill refinement RULE as described in Table "Field descriptions for conditional datafill" on the next page.</p> <p>Each rule of screening function must be of the same network type. The network type of a screening function cannot be changed.</p>

NETTYPE = ANSI7 and NTC7

If the entry in subfield NETTYPE is ANSI7 or NTC7, datafill refinement RULE as described in the following table, then go to field REMARKS as described in Table "Field descriptions" in the Section "For all network types".

C7BLKDPC (continued)

Field descriptions for conditional datafill (Sheet 1 of 3)

Field	Subfield or refinement	Entry	Explanation and action
	RULE	see subfield	<i>Rule</i> This field defines the screening rule and consists of subfield RULETYPE.
	RULETYPE	BLOCK or DEFAULT	<p><i>Rule type</i>This field identifies the type of rule and the range of DPCs covered by this rule.</p> <p>Enter DEFAULT if no other rule applies and datafill refinement RESULT. For a DEFAULT rule</p> <ul style="list-style-type: none"> • field RULENO must contain 0 (zero) • be the first rule specified in field REFERNCE • have a result associated with it in field RESULT <p>Subfields FROMPC and TOPC are not specified with the DEFAULT rule type.</p> <p>Enter BLOCK to identify a range of DPCs that are blocked and datafill refinement BLOCK. A BLOCK rule must</p> <ul style="list-style-type: none"> • have a value between 1 and 255 datafilled in field RULENO • be added after the default rule for a screening reference in field REFERNCE • have associated subfields TOPC and FROMPC, or PCRANGE
BLOCK		see subfield	<i>Block</i> If the entry in subfield RULETYPE is BLOCK, datafill this refinement. This field consists of subfields FROMPC and TOPC.

C7BLKDPC (continued)

Field descriptions for conditional datafill (Sheet 2 of 3)

Field	Subfield or refinement	Entry	Explanation and action
	FROMPC	0 to 255	<p><i>From point code</i> For a NETTYPE of ANSI7, enter a full DPC representing the start of the range of DPCs to which this rule applies. Up to three values can be datafilled. If less than three values are required, end the list with a \$.</p> <p>For a NETTYPE of NTC7, enter a full DPC representing the start of the range of DPCs to which this rule applies. The \$ (dollar sign) is not allowed.</p> <p>The value of field FROMPC must be less than or equal to the value in field TOPC.</p>
	TOPC	0 to 255	<p><i>To point code</i> For a NETTYPE of ANSI7, enter a full or partial originating point code (OPC) representing the end of the range of OPCs to which this rule applies. Up to three values can be datafilled. If less than three values are required, end the list with a blank column and a \$.</p> <p>For a NETTYPE of NTC7, enter a full OPC representing the end of the range of OPCs to which this rule applies. The \$ (dollar sign) is not allowed.</p> <p>The value of field TOPC must be greater than or equal to the value in field FROMPC.</p>
RESULT		see subfields	<p><i>Result</i> If the entry in subfield RULETYPE is DEFAULT, datafill this refinement. This field consists of subfields NEXTFN and NEXTREF.</p>

C7BLKDPC (continued)**Field descriptions for conditional datafill (Sheet 3 of 3)**

Field	Subfield or refinement	Entry	Explanation and action
	NEXTFN	C7DSTFLD or STOP	<p><i>Next screening function</i> Enter the next screening function to be performed.</p> <p>If the entry is STOP, no refinements require datafill.</p> <p>If the entry is C7DSTFLD, datafill refinement NEXTREF.</p> <p>If the network type is CCITT7, an entry of C7CGPA in this field is not permitted.</p>
	NEXTREF	alphanumeric	<p><i>Next screening referencelf</i> entry in subfield NEXTFN is other than STOP, enter the value in field REFERNCE of the screening table that was specified in field NEXTFN that designates the next screening function to be performed.</p>

NETTYPE = CCITT7

If the entry in subfield NETTYPE is CCITT7, datafill refinement RULE as described in the following table, then go to field REMARKS as described in Table “Field descriptions” in Section “For all network types”..

C7BLKDPC (continued)**Field descriptions for conditional datafill (Sheet 1 of 3)**

Field	Subfield or refinement	Entry	Explanation and action
RULE		see subfields	<i>Rule</i> This field defines the screening rule and consists of subfields RULETYPE.
	RULETYPE	BLOCK or DEFAULT	<p><i>Rule type</i>This field identifies the type of rule and the range of DPCs covered by this rule.</p> <p>Enter DEFAULT if no other rule applies and datafill refinement RESULT. For a DEFAULT rule</p> <ul style="list-style-type: none"> • field RULENO must contain 0 (zero) • be the first rule specified in field REFERNCE • have a result associated with it in field RESULT <p>Subfields FROMPC and TOPC are not specified with the DEFAULT rule type.</p> <p>Enter BLOCK to identify a range of DPCs that are blocked and datafill refinement BLOCK. A BLOCK rule must</p> <ul style="list-style-type: none"> • have a value between 1 and 255 datafilled in field RULENO • be added after the default rule for a screening reference in field REFERNCE • have associated subfields TOPC and FROMPC, or PCRANGE.
BLOCK		see subfield	<i>Block</i> This field consists of subfield PCRANGE.
	PCRANGE	see subfield	<i>CCITT point code range</i> This field consists of subfield FORMAT.
	FORMAT	BASIC or INTL	<p><i>Format of CCITT point codes</i>For international format, enter INTL.</p> <p>For non-international format, enter BASIC.</p>

C7BLKDPC (continued)

Field descriptions for conditional datafill (Sheet 2 of 3)

Field	Subfield or refinement	Entry	Explanation and action
FROMPC		0 to 16383 or see subfields	<p><i>From point code</i>If the entry in subfield FORMAT is BASIC, enter a full originating point code (OPC) representing the start of the range of OPCs to which this rule applies.</p> <p>If the entry in subfield FORMAT is INTL, this field consists of subfields FROMZONE, FROMAREA, and FRMPOINT. Separate each subfield with a single space.</p> <p>The value of field FROMPC must be less than or equal to the value in field TOPC.</p>
	FROMZONE	0 to 7	<p><i>From zone</i>Enter a value in the field FROMZONE for the OPC to which this rule applies.</p>
	FROMAREA	0 to 255	<p><i>From area</i>Enter a value in the field FROMAREA for the OPC to which this rule applies.</p>
	FROMPOINT	0 to 7	<p><i>From point</i>Enter a value in the field FROMPOINT for the OPC to which this rule applies.</p>
	TOPC	see subfields	<p><i>To point code</i>This field consists of subfields TOZONE, TOAREA, and TOPOINT. Separate each subfield with a single space.</p> <p>The value of field TOPC must be greater than or equal to the value in field FROMPC.</p>
	TOZONE	0 to 7	<p><i>To zone</i>Enter a value in the field TOZONE for the OPC to which this rule applies.</p>
	TOAREA	0 to 255	<p><i>To area</i>Enter a value in the field TOAREA for the OPC to which this rule applies.</p>
	TOPOINT	0 to 7	<p><i>To point</i>Enter the point of the OPC to which this rule applies.</p>
RESULT		see subfields	<p><i>Result</i>If the entry in subfield RULETYPE is DEFAULT, datafill this refinement. This field is consists of subfields NEXTFN and NEXTREF.</p>

C7BLKDPC (continued)**Field descriptions for conditional datafill (Sheet 3 of 3)**

Field	Subfield or refinement	Entry	Explanation and action
	NEXTFN	C7CGPA C7DSTFLD or STOP	<i>Next screening function</i> Enter the next screening function to be performed. If the entry is STOP, no refinements require datafill. If the entry is C7CGPA or C7DSTFLD, datafill refinement NEXTREF. If the network type is CCITT7, an entry of C7CGPA in this field is not permitted.
	NEXTREF	alphanumeric	<i>Next screening referencelf</i> entry in subfield NEXTFN is other than STOP, enter the value in field REFERNCE of the screening table that is specified in field NEXTFN that designates the next screening function to be performed.

For all network types

For all network types, continue datafill with fields REMARKS and OPTIONS as described in the following table.

Field descriptions

Field	Subfield or refinement	Entry	Explanation and action
REMARKS		alphanumeric (1 to 8 characters)	<i>Remarks</i> This field is specified by the operating company and can be used to identify the name of the network or carrier to which the link is connected. Any eight-character value can be stored in this field. Avoid the use of special characters, such as +, *, /, -, and %.
OPTIONS		see subfields	<i>Options</i> This field is used to specify CCS7 screening options. It consists of subfield OPTNAME.
	OPTNAME	\$	<i>Option name</i> Enter \$, which is the only valid entry.

Datafill example

The following example shows sample datafill for table C7BLKDPC.

C7BLKDPC (continued)

The screening rules in a “blocked” screening table specify those values in the CCS7 message that are not allowed. If one of the screening rules matches the message being screened, then the message is not allowed and is discarded. If no screening rule matches the message being screened it is routed to the next screening table by the DEFAULT rule.

MAP display example for table C7BLKDPC

SCRNREF	OPTIONS	SCRNRULE	REMARKS
REF5 0		ANSI7 DEFAULT C7CGPA REF6	\$
\$			
REF5 1	ANSI7 BLOCK (1) (1) (2)\$ (1) (1) (2)\$		\$
\$			
REF5 2	ANSI7 BLOCK (1) (1) (3)\$ (1) (1) (3)\$		\$
\$			
REF5 3	ANSI7 BLOCK (1) (1) (4)\$ (1) (1) (4)\$		\$
\$			
REF5 4	ANSI7 BLOCK (1) (1) (5)\$ (1) (1) (5)\$		\$
\$			

Table history**STP04.0**

Removed references to MDR7 screening.

CSP06

Information removed about bulk deletion workaround.

CSP02

Information added about the possibility of service degradation if gateway screening is not turned off.

BCS36

Refinement MAXOCTET removed. Information added about bulk deletions.

Supplementary information

This section provides information on deleting datafill in table C7BLKDPC.

C7BLKDPC (end)

Datafill modifications



DANGER

Risk of service degradation

A service degradation can occur if gateway screening is not turned off in table C7GTWLKS prior to making additions, deletions, or changes to table C7BLKDPC.

The table control warning is displayed at the MAP display if a user attempts to add, change, or delete tuples in table C7BLKDPC.

A similar message is displayed in all the gateway screening tables (C7AFTPC, C7ALWDPC, C7ALWGTT, C7ALWOPC, C7ALWSIO, C7BLKDPC, C7BLKOPC, C7BLKSIO for CCITT only, C7CDPA, C7CGPA, and C7DSTFLD).

Note: The VERIFY function must be turned on. If VERIFY is off, this warning is not displayed.

C7BLKOPC

Table name

CCS7 Gateway STP Blocked Originating Point Codes Screening Table

Functional description

Table C7BLKOPC specifies screening functions for blocked originating point codes (OPC). Each screening function consists of a set of one or more screening rules. For each screening reference, the DEFAULT rule must be the first specified rule. Each screening rule can have a different screening result.

Note: All references to signaling transfer point (STP) are also applicable to STP/Service Switching Point (SSP) Integrated Nodes (INode), unless otherwise specified.

For related information, refer to table C7GTWLKS.

Datafill sequence and implications

The following tables (if required) must be datafilled before table C7BLKOPC:

- C7ALWDPC
- C7ALWSIO
- C7BLKDPC
- C7BLKSIO (network type CCITT7 only)
- C7CGPA
- C7DSTFLD

The following tables (if required) must be datafilled after table C7BLKOPC:

- C7ALWOPC
- C7GTWLKS

Table size

32 767 tuples

Up to 2000 tuples

The limit of 2000 tuples for this table depends on the datafill in the other gateway screening tables. There are a maximum of 2000 possible screening rules for all of the gateway tables (except table C7GTWLKS).

C7BLKOPC (continued)

- The limit of 32 767 tuples for this table depends on the datafill in the other gateway screening tables. There are a maximum of 32 767 possible screening rules for all of the gateway tables (except table C7GTWLKS), therefore the maximum number of tuples for the tables is 32, 767 with the following restrictions:
- up to 1024 screening references for all tables
- up to 256 rules for each screening reference

Datafill

The following table lists datafill for table C7BLKOPC.

Field descriptions (Sheet 1 of 2)

Field	Subfield or refinement	Entry	Explanation and action
SCRNREF		see subfields	<i>Screening reference</i> This field is the key to the table and consists of subfields REFERNCE and RULENO.
	REFERNCE	alphanumeric (1 to 4 characters)	<i>Screening reference</i> Enter a value that uniquely identifies a blocked destination point code (DPC) screening function.
	RULENO	0 to 255	<i>Rule number</i> Enter a number to identify a rule in a screening function. Each screening function can consist of up to 256 distinct rules. This is the second part of a two part key. A value of 0 (zero) can only be used if subfield RULETYPE has a value of DEFAULT.
SCRNRULE		see subfields	<i>Rule type</i> This field contains all of the screening rule information and consists of subfield NETTYPE.
	NETTYPE	ANSI7, CCITT7, or NTC7	<i>Network type</i> Enter the network type of the screening rule. Enter ANSI7 if the point codes screened are in the ANSI format and datafill refinement RULE described in the following table.

C7BLKOPC (continued)**Field descriptions (Sheet 2 of 2)**

Field	Subfield or refinement	Entry	Explanation and action
			<p>Enter CCITT7 if the point codes screened are in the CCITT7 format and datafill refinement RULE described in the field description table in Section "NETTYPE = CCITT7"..</p> <p>Enter NTC7 if the point codes screened are in the NTC7 format and datafill refinement RULE described in the following table..</p> <p>Each rule of screening function must be of the same network type. The network type of a screening function cannot be changed.</p>

NETTYPE = ANSI7 and NTC7

If the entry in subfield NETTYPE is ANSI7 or NTC7, datafill refinement RULE as described in the following table, then go to field REMARKS described in the field descriptions table in Section "For all network types".

C7BLKOPC (continued)**Field descriptions for conditional datafill (Sheet 1 of 3)**

Field	Subfield or refinement	Entry	Explanation and action
	RULE	see subfield	<i>Rule</i> This field defines the screening rule and consists of subfield RULETYPE.
	RULETYPE	BLOCK or DEFAULT	<p><i>Rule type</i>This field identifies the type of rule and the range of DPC covered by this rule.</p> <p>Enter DEFAULT if no other rule applies and datafill refinement RESULT. For a DEFAULT rule</p> <ul style="list-style-type: none"> • field RULENO must contain 0 (zero) • be the first rule specified in field REFERNCE • have a result associated with it in field RESULT <p>Subfields FROMPC and TOPC are not specified with the DEFAULT rule type.</p> <p>Enter BLOCK to identify a range of DPCs that are blocked and datafill refinement BLOCK. A BLOCK rule must</p> <ul style="list-style-type: none"> • have a value between 1 and 255 datafilled in field RULENO • be added after the default rule for a screening reference in field REFERNCE • have associated subfields TOPC and FROMPC, or PCRANGE.
	BLOCK	see subfield	<i>Block</i> If the entry in subfield RULETYPE is BLOCK, datafill this refinement. This field consists of subfields FROMPC and TOPC.

C7BLKOPC (continued)

Field descriptions for conditional datafill (Sheet 2 of 3)

Field	Subfield or refinement	Entry	Explanation and action
	FROMPC	0 to 255	<p><i>From point code</i> For a NETTYPE of ANSI7, enter a full or partial originating point code (OPC) representing the start of the range of OPCs to which this rule applies. Up to three values can be datafilled. If less than three values are required, end the list with a \$.</p> <p>For a NETTYPE of NTC7, enter a full OPC representing the start of the range of OPCs to which this rule applies. The \$ (dollar sign) is not allowed.</p> <p>The value of field FROMPC must be less than or equal to the value in field TOPC.</p> <ul style="list-style-type: none"> • The network identifier of fields FROMPC and TOPC must be in the range 1 to 255 (a value of 0 is not valid). • The point code range represented by fields FROMPC and TOPC is one of the following types: <ul style="list-style-type: none"> — a single point code — a range of, or all of, the point codes in a network cluster — a range of, or all of, the network clusters in a network identifier — a range of, or all of, the network identifiers in the entire range of point codes
	TOPC	0 to 255	<p><i>To point code</i> For a NETTYPE of ANSI7, enter a full or partial OPC representing the end of the range of OPCs to which this rule applies. Up to three values can be datafilled. If less than three values are required, end the list with a blank column and a \$.</p> <p>For a NETTYPE of NTC7, enter a full OPC representing the end of the range of OPCs to which this rule applies. The \$ (dollar sign) is not allowed.</p> <p>The value of field TOPC must be greater than or equal to the value in field FROMPC.</p>

C7BLKOPC (continued)

Field descriptions for conditional datafill (Sheet 3 of 3)

Field	Subfield or refinement	Entry	Explanation and action
	RESULT	see subfields	<i>Result</i> If the entry in subfield RULETYPE is DEFAULT, datafill this refinement. This field consists of subfields NEXTFN and NEXTREF.
	NEXTFN	C7ALWDPC C7ALWSIO C7BLKDPC C7CGPA C7DSTFLD or STOP	<i>Next screening function</i> Enter the next screening function to be performed. If the entry is STOP, no refinements require datafill. If the entry is any entry other than STOP, datafill refinement NEXTREF.
	NEXTREF	alphanumeric	<i>Next screening reference</i> If entry in subfield NEXTFN is other than STOP, enter the value, in field REFERNCE of the screening table that is specified in field NEXTFN, that designates the next screening function to be performed.

NETTYPE = CCITT7

If the entry in subfield NETTYPE is CCITT7, datafill refinement RULE as described below, then go to field REMARKS described in the field descriptions table in Section “For all network types”.

C7BLKOPC (continued)**Field descriptions for conditional datafill (Sheet 1 of 3)**

Field	Subfield or refinement	Entry	Explanation and action
	RULE	see subfield	<i>Rule</i> This field defines the screening rule and consists of subfield RULETYPE.
	RULETYPE	BLOCK or DEFAULT	<p><i>Rule type</i>This field identifies the type of rule and the range of destination point codes (DPC) covered by this rule.</p> <p>Enter BLOCK to identify a range of DPCs that are blocked and datafill refinement BLOCK. A BLOCK rule must</p> <ul style="list-style-type: none"> • have a value between 1 and 255 datafilled in field RULENO • be added after the default rule for a screening reference in field REFERNCE • have associated subfields TOPC and FROMPC, or PCRANGE <p>Enter DEFAULT if no other rule applies and datafill refinement RESULT described later in this table. For a DEFAULT rule</p> <ul style="list-style-type: none"> • field RULENO must contain 0 (zero) • be the first rule specified in field REFERNCE • have a result associated with it in field RESULT <p>Subfields FROMPC and TOPC are not specified with the DEFAULT rule type.</p>
	BLOCK	see subfield	<i>Block</i> This field consists of subfield PCRANGE.
	PCRANGE	see subfield	<i>CCITT point code range</i> This field consists of subfield FORMAT.
	FORMAT	BASIC or INTL	<p><i>Format of CCITT point codes</i>For international format, enter INTL.</p> <p>For noninternational format, enter BASIC.</p>

C7BLKOPC (continued)

Field descriptions for conditional datafill (Sheet 2 of 3)

Field	Subfield or refinement	Entry	Explanation and action
TOPC	FROMPC	0 to 16 383 or see subfields	<p><i>From point code</i> If the entry in subfield FORMAT is BASIC, enter a full OPC representing the start of the range of OPCs to which this rule applies.</p> <p>If the entry in subfield FORMAT is INTL, this field consists of subfields FROMZONE, FROMAREA, and FRMPOINT. Separate each subfield with a single space.</p> <p>The value of field FROMPC must be less than or equal to the value in field TOPC.</p>
	FROMZONE	0 to 7	<i>From zone</i> Enter a value in the field FROMZONE for the OPC to which this rule applies.
	FROMAREA	0 to 255	<i>From area</i> Enter a value in the field FROMAREA for the OPC to which this rule applies.
	FROMPOINT	0 to 7	<i>From point</i> Enter a value in the field FROMPOINT for the OPC to which this rule applies.
		0 to 16 383 or see subfields	<p><i>To point code</i> This field consists of subfields TOZONE, TOAREA, and TOPOINT. Separate each subfield with a single space.</p> <p>If the entry in subfield FORMAT is BASIC, enter a full OPC representing the end of the range of the OPCs to which this rules applies.</p> <p>The value of field TOPC must be greater than or equal to the value in field FROMPC.</p>
	TOZONE	0 to 7	<i>To zone</i> Enter a value for the field TOZONE for the OPC to which this rule applies.
	TOAREA	0 to 255	<i>To area</i> Enter a value for the field TOAREA for the OPC to which this rule applies.
	TOPOINT	0 to 7	<i>To point</i> Enter a value for the field TOPOINT for the OPC to which this rule applies.

C7BLKOPC (continued)**Field descriptions for conditional datafill (Sheet 3 of 3)**

Field	Subfield or refinement	Entry	Explanation and action
	RESULT	see subfields	<i>Result</i> If the entry in subfield RULETYPE is DEFAULT, datafill this refinement. This field consists of subfields NEXTFN and NEXTREF.
	NEXTFN	C7ALWDPC C7ALWSIO C7BLKDPC C7BLKSIO C7DSTFLD or STOP	<i>Next screening function</i> Enter the next screening function to be performed. If the entry is STOP, no refinements require datafill. If the entry is any entry other than STOP, datafill refinement NEXTREF. If the network type is CCITT7, an entry of C7CGPA in this field is not permitted.
	NEXTREF	alphanumeric	<i>Next screening reference</i> If entry in subfield NEXTFN is other than STOP, enter the value, in field REFERNCE of the screening table that is specified in field NEXTFN, that designates the next screening function to be performed.

For all network types

For all network types, continue datafill with fields REMARKS and OPTIONS as described in the following table.

Field descriptions (Sheet 1 of 2)

Field	Subfield or refinement	Entry	Explanation and action
REMARKS		alphanumeric (1 to 8 characters)	<i>Remarks</i> This field is specified by the operating company and can be used to identify the name of the network or carrier to which the link is connected. Any eight-character value can be stored in this field. Avoid the use of special characters, such as +, *, /, -, and %.

C7BLKOPC (continued)

Field descriptions (Sheet 2 of 2)

Field	Subfield or refinement	Entry	Explanation and action
OPTIONS		see subfields	<i>Options</i> This field is used to specify CCS7 screening options. It consists of subfield OPTNAME.
	OPTNAME	\$	<i>Option name</i> Enter \$, which is the only valid entry.

Datafill example

The following example shows sample datafill for table C7BLKOPC.

The screening rules in a “blocked” screening table specify the values in the CCS7 message that are not allowed. If one of the screening rules matches the screened message, the message is not allowed and is discarded. If no screening rule matches the screened message, it is routed to the next screening table by the DEFAULT rule (subfield RULETYPE).

MAP display example for table C7BLKOPC

SCRNREF	SCRNRULE	REMARKS
OPTIONS		
REF2 0	ANSI7 DEFAULT C7CGPA REF6	\$
\$		
REF2 1	ANSI7 BLOCK (1) (1) (2)\$ (1) (1) (2)\$	\$
\$		
REF2 2	ANSI7 BLOCK (1) (1) (3)\$ (1) (1) (3)\$	\$
\$		
REF2 3	ANSI7 BLOCK (1) (1) (4)\$ (1) (1) (4)\$	\$
\$		
REF2 4	ANSI7 BLOCK (1) (1) (5)\$ (1) (1) (5)\$	\$
\$		

Table history

STP04.0

Removed references to MDR7 screening.

C7BLKOPC (end)

CSP06

Information removed about bulk deletion workaround.

CSP02

Information added about the possibility of service degradation if gateway screening is not turned off.

BCS36

Refinement MAXOCTET removed. Information added about bulk deletions.

Supplementary information

This section provides information on modifying datafill in table C7BLKOPC.

Datafill modifications**DANGER****Risk of service degradation**

A service degradation can occur if gateway screening is not turned off in table C7GTWLKS prior to making additions, deletions, or changes to table C7BLKSIO (for CCITT only).

The previous table control warning is displayed at the MAP display if a user attempts to add, change, or delete tuples in table C7BLKSIO.

A similar message is displayed in all the gateway screening tables (C7AFTPC, C7ALWDPC, C7ALWGTT, C7ALWOPC, C7ALWSIO, C7BLKDPC, C7BLKOPC, C7BLKSIO for CCITT only, C7CDPA, C7CGPA, and C7DSTFLD).

Note: The VERIFY function must be turned on. If VERIFY is off, the above warning is not displayed.

C7BLKSIO

Table name

CCS7 Gateway STP Blocked Service Information Octets Screening Table

Functional description

Table C7BLKSIO is used to specify screening functions for blocked service information octets (SIO). Each screening function consists of a set of one or more screening rules. For each screening reference, the DEFAULT rule must be the first specified rule. Each screening rule can have a different screening result.

Note: All references to signaling transfer point (STP) are applicable to STP/Service Switching Point (SSP) Integrated Nodes (INode), unless otherwise specified.

Datafill sequence and implications

There is no requirement to datafill other tables prior to table C7BLKSIO.

Table size

0 to 32 767 tuples

Up to 2000 tuples for American National Standards Institute (ANSI) network type.

Up to 200 tuples for International Telecommunication Union (ITU), formerly International Telegraph and Telephone Consultative Committee (CCITT), network type.

The limit of 2000 tuples for this table depends on the datafill in the other gateway screening tables. There are a maximum of 2000 possible screening rules for all of the gateway tables (except table C7GTWLKS).

The limit of 32 767 tuples for this table depends on the datafill in the other gateway screening tables. There are a maximum of 32 767 possible screening rules for all of the gateway tables (except table C7GTWLKS), therefore the maximum number of tuples for the tables is 32 767 with the following restrictions:

- up to 1024 screening references for all tables
- up to 256 rules for each screening reference

C7BLKSIO (continued)**Datafill**

The following table lists datafill for table C7BLKSIO.

Field descriptions (Sheet 1 of 5)

Field	Subfield or refinement	Entry	Explanation and action
SCRNREF		see subfields	<i>Screening reference</i> This field is the key to the table and consists of subfields REFERNCE and RULENO.
	REFERNCE	alphanumeric (1 to 4 characters)	<i>Screening reference</i> Enter a value that uniquely identifies a blocked service information octet (SIO) screening function.
	RULENO	0 to 255	<i>Rule number</i> Enter a number to identify a rule in a screening function. Each screening function can consist of up to 256 distinct rules.
SCRNRULE		see subfield	<i>Rule type</i> This field contains all of the screening rule information and consists of subfield NETTYPE.
	NETTYPE	CCITT7	<i>Network type</i> Enter the network type of the screening rule. Enter CCITT7 if the point codes screened are in the CCITT7 format and datafill refinement RULE. Each rule of a screening function must be of the same network type. The network type of a screening function cannot be changed.
	RULE	see subfield	<i>Rule</i> This field defines the screening rule and includes the subfield RULETYPE.

C7BLKSIO (continued)

Field descriptions (Sheet 2 of 5)

Field	Subfield or refinement	Entry	Explanation and action
	RULETYPE	BLOCK or DEFAULT	<p><i>Rule type</i>This field identifies the type of rule and the range of service information octets (SIO).</p> <p>Enter BLOCK to identify a range of SIOs that are blocked and datafill refinement BLOCK. A BLOCK rule must</p> <ul style="list-style-type: none"> • have a value between 1 and 255 datafilled in field RULENO • be added after the default rule for a screening reference in field REFERENCE <p>Enter DEFAULT if no other rule applies and datafill refinement RESULT described later in this table. For a DEFAULT rule</p> <ul style="list-style-type: none"> • field RULENO must contain 0 (zero) • be the first rule specified in field REFERENCE • have a result associated with it in field RESULT <p>Subfields are not specified with the DEFAULT rule type.</p>
	BLOCK	see subfield	<p><i>Block</i>If the entry in subfield RULETYPE is BLOCK, datafill this refinement. This field consists of subfields FROMSI, TOSI, FROMH0, TOH0, FROMH1, and TOH1.</p>
	FROMSI	one vector or \$	<p><i>From service indicators</i>Enter one of the service indicators (SI) representing the start of the range of SIs to which this rule applies. The value in FROMSI must be less than the value in TOSI.</p> <p>If the rule includes all SIs, enter \$ to indicate no SIs are specified in both FROMSI and TOSI.</p>

C7BLKSIO (continued)

Field descriptions (Sheet 3 of 5)

Field	Subfield or refinement	Entry	Explanation and action
	TOSI	one vector or \$	<p><i>To service indicators</i> Enter one of the SIs representing the end of the range of SIs to which this rule applies. The value in TOSI must be greater than the value in FROMSI.</p> <p>If the rule includes all SIs, enter \$ to indicate no SIs are specified in both FROMSI and TOSI.</p>
	FROMH0	0 to 15 or \$	<p><i>From H0</i> Enter one of the values of the H0 code representing the start of the range of H0 codes to which this rule applies. The value in FROMH0 must be less than the value in TOH0.</p> <p>These fields can only be datafilled when the SI of the message is 0, 1, 2, or 4.</p> <p>If the rule includes all values of the H0 code, enter \$ to indicate no H0 code values are specified in both FROMH0 and TOH0.</p>
	TOH0	0 to 15 or \$	<p><i>To H0</i> Enter one of the values of the H0 code representing the end of the range of H0 codes to which this rule applies. The value in TOH0 must be greater than the value in FROMH0.</p> <p>These fields can only be datafilled when the SI of the message is 0, 1, 2, or 4.</p> <p>If the rule includes all values of the H0 code, enter \$ to indicate no H0 code values are specified in both FROMH0 and TOH0.</p>
	FROMH1	0 to 15 or \$	<p><i>From H1</i> Enter one of the values of the H1 code representing the start of the range of H1 codes to which this rule applies. The value in FROMH1 must be less than the value in TOH1.</p> <p>These fields can only be datafilled when the SI of the message is 0, 1, 2, or 4.</p> <p>If the rule includes all values of the H1 code, enter \$ to indicate no H1 code values are specified in both FROMH1 and TOH1.</p>

C7BLKSIO (continued)

Field descriptions (Sheet 4 of 5)

Field	Subfield or refinement	Entry	Explanation and action
	TOH1	0 to 15 or \$	<p><i>To H1</i> Enter one of the values of the H1 code representing the end of the range of H1 codes to which this rule applies. The value in TOH1 must be greater than the value in FROMH1.</p> <p>These fields can only be datafilled when the SI of the message is 0, 1, 2, or 4.</p> <p>If the rule includes all values of the H1 code, enter \$ to indicate no H1 code values are specified in both FROMH1 and TOH1.</p>
	RESULT	see subfields	<p><i>Result</i> If the entry in subfield RULETYPE is DEFAULT, datafill this refinement. This field consists of subfields NEXTFN and NEXTREF.</p>
	NEXTFN	C7ALWDPC C7BLKDPC C7DSTFLD or STOP	<p><i>Next screening function</i> Enter the next screening function to be performed.</p> <p>If the entry is STOP, no refinements require datafill.</p> <p>If the entry is any entry other than STOP, datafill refinement NEXTREF.</p>
	NEXTREF	alphanumeric	<p><i>Next screening reference</i> If entry in subfield NEXTFN is other than STOP, enter the value in field REFERNCE of the screening table that was specified in field NEXTFN that designates the next screening function to be performed.</p>
REMARKS		alphanumeric (1 to 8 characters)	<p><i>Remarks</i> This field is specified by the operating company and can be used to identify the name of the network or carrier to which the link is connected. Any eight-character value can be stored in this field. Avoid the use of special characters, such as +, *, /, -, and %.</p>

C7BLKSIO (continued)

Field descriptions (Sheet 5 of 5)

Field	Subfield or refinement	Entry	Explanation and action
OPTIONS		see subfield	<i>Options</i> This field is used to specify CCS7 screening options. It consists of subfield OPTNAME.
	OPTNAME	\$	<i>Option name</i> Enter \$, which is the only valid entry.

Datafill example

The following example shows sample datafill for table C7BLKSIO.

MAP display example for table C7BLKSIO

SCRNREF	SCRNRULE	REMARKS
OPTIONS		
REF0 0	CCITT7 DEFAULT C7ALWDPC REF0	\$
\$		
REF0 1	CCITT7 BLOCK (0)\$ (2)\$ (0)\$ (15)\$ (0)\$ (15)\$	\$
\$		
REF0 2	CCITT7 BLOCK (4)\$ (4)\$ (0)\$ (0)\$ (0)\$ (0)\$	\$
\$		

Table history

STP04.0

Removed references to MDR7 screening.

CSP06

Information removed about bulk deletion workaround.

CSP02

Information added about the possibility of service degradation if gateway screening is not turned off.

C7BLKSIO (end)

BCS36

Refinement MAXOCTET removed. Information added about bulk deletions.

Supplementary information

This section provides information on modifying datafill for CCITT in table C7BLKSIO.

Datafill modifications



DANGER

Risk of service degradation

A service degradation can occur if gateway screening is not turned off in table C7GTWLKS prior to making additions, deletions, or changes to table C7BLKSIO (for CCITT only).

The previous table control warning is displayed at the MAP display if a user attempts to add, change, or delete tuples in table C7BLKSIO.

A similar message is displayed in all the gateway screening tables (C7AFTPC, C7ALWDPC, C7ALWGTT, C7ALWOPC, C7ALWSIO, C7BLKDPC, C7BLKOPC, C7BLKSIO for CCITT only, C7CDPA, C7CGPA, and C7DSTFLD).

Note: The VERIFY function must be turned on. If VERIFY is off, the above warning is not displayed.

C7CDPA

Table name

CCS7 Gateway STP SCCP Called Party Address Screening Table

Functional description

Table C7CDPA screens messages in American National Standards Institute (ANSI) and NTC7 format. It defines the gateway screening functions for the signaling connection control part (SCCP) called party address (CDPA).

Note: All references to signaling transfer point (STP) are applicable to the STP/Service Switching Point (SSP) Integrated Nodes (INode), unless otherwise specified.

For related information, refer to table C7GTWLKS.

Datafill sequence and implications

Table C7AFTPC (if required) must be datafilled before table C7CDPA.

The following tables (if required) must be datafilled after table C7CDPA:

- C7CGPA
- C7ALWGTT
- C7ALWSIO

Table size

0 to 32 767 tuples

Up to 400 tuples

Table size restrictions

The limit of 400 tuples for this table depends on the datafill in the other gateway screening tables.

The limit of 32 767 tuples for this table depends on the datafill in the other gateway screening tables. There is a maximum of 32 767 possible screening rules for all gateway tables (except table C7GTWLKS) so the maximum number of tuples for the tables is 32 767 with the following restrictions:

- up to 1024 screening references for all tables
- up to 256 rules for each screening reference

C7CDPA (continued)**Datafill**

The following table lists datafill for table C7CDPA.

Field descriptions (Sheet 1 of 5)

Field	Subfield or refinement	Entry	Explanation and action
SCRNREF		see subfields	<i>Screening reference</i> This field consists of subfields REFERNCE and RULENO.
	REFERNCE	alphanumeric (1 to 4 characters)	<i>Screening reference</i> Enter a value that uniquely identifies a called party address (CDPA) screening function.
	RULENO	0 to 255	<i>Rule number</i> Enter a number to identify a rule within a screening function. Each screening function consists of up to 256 distinct rules.
SCRNRULE		see subfields	<i>Screening rule</i> This field contains all the screening rule information and consists of subfields NETTYPE, FROMPC, TOPC, FROMSSN, TOSSN, FRSCMGMT, TOSCMGMT, and RESULT.
	NETTYPE	ANSI7 or NTC7	<i>Network type</i> Enter ANSI7 if the point codes screened are in ANSI format. This table is not used for screening messages in the CCITT format. Enter NTC7 if the point codes screened are in NTC7 format. Entries outside the range indicated for this field are invalid.
	FROMPC	a vector from 0 to 3 values in the range 0 to 255	<i>From point codes</i> For a NETTYPE of ANSI7, enter a full or partial destination point code (DPC) representing the start of the range of DPCs to which this rule applies. This is specified as a vector of zero to three values in the range 0 to 255. End the vector with a blank space and a \$. The value of subfield FROMPC must be less than or equal to subfield TOPC. For a NETTYPE of NTC7, enter a full DPC representing the start of the range of DPCs to which the rule applies. The \$ (dollar sign) is not allowed.

C7CDPA (continued)

Field descriptions (Sheet 2 of 5)

Field	Subfield or refinement	Entry	Explanation and action
	TOPC	a vector from 0 to 3 values in the range 0 to 255	<ul style="list-style-type: none"> • <i>Note:</i> The following additional restrictions are applied to each tuple only if they have the network type ANSI7 and if the Signaling, Engineering, and Administration System (SEAS) software is present in the STP: • The network identifier of fields FROMPC and TOPC must be in the range 1 to 255 (a value of 0 [zero] is not valid). • The point code range represented by fields FROMPC and TOPC can only be one of the following types of ranges: <ul style="list-style-type: none"> — a single point code — a range of, or all of, the point codes within a network cluster — a range of, or all of, the network clusters within a network identifier — a range of, or all of, the network identifiers within the entire range of point codes <p><i>To point code</i> For a NETTYPE of ANSI7, enter a full or partial destination point code representing the end of the range of destination point codes to which this rule applies. This is specified as a vector of zero to three values in the range 0 to 255.</p> <p>The value of subfield TOPC must be greater than or equal to subfield FROMPC.</p> <p>End the vector with a blank space and a \$.</p> <p>For a NETTYPE of NTC7, enter a full DPC representing the end of the range of DPCs to which the rule applies. The \$ (dollar sign) is not allowed.</p>

C7CDPA (continued)

Field descriptions (Sheet 3 of 5)

Field	Subfield or refinement	Entry	Explanation and action
	FROMSSN	0 to 255 or \$	<ul style="list-style-type: none"> • <i>Note:</i> The following additional restrictions are applied to each tuple only if they have the network type ANSI7 and if the Signaling, Engineering, and Administration System (SEAS) software is present in the STP: • The network identifier of fields FROMPC and TOPC must be in the range 1 to 255 (a value of 0 [zero] is not valid). • The point code range represented by fields FROMPC and TOPC can only be one of the following types of ranges: <ul style="list-style-type: none"> — a single point code — a range of, or all of, the point codes within a network cluster — a range of, or all of, the network clusters within a network identifier — a range of, or all of, the network identifiers within the entire range of point codes <p><i>From subsystem number</i> Enter one of the subsystem numbers representing the start of the range of subsystem numbers to which this rule applies.</p> <p>The value in subfield FROMSSN must be less than the value in subfield TOSSN.</p> <p>If the rule includes all subsystem numbers, enter \$ (no subsystem numbers specified) in subfields FROMSSN and TOSSN.</p>

C7CDPA (continued)

Field descriptions (Sheet 4 of 5)

Field	Subfield or refinement	Entry	Explanation and action
	TOSSN	0 to 255 or \$	<p><i>To subsystem number</i> Enter one of the subsystem numbers representing the end of the range of subsystem numbers to which this rule applies. The value in subfield TOSSN must be greater than the value in subfield FROMSSN.</p> <p>If the rule includes all subsystem numbers, enter \$ (no subsystem numbers specified) in subfields FROMSSN and TOSSN.</p>
	FRSCMGMT	0 to 255 or \$	<p><i>From SCCP management message types</i> Enter one of the signaling connection control part (SCCP) management (SCMG) message types representing the start of the range of SCMG message types to which this rule applies.</p> <p>The value in subfield FRSCMGMT must be less than the value in subfield TOSCMGMT.</p> <p>This field is only significant when the subsystem number of the CDPA being screened is 1 (SCMG). If the subsystem number is other than 1, enter \$.</p> <p>Note: If the subsystem number is 1, the SCMG format identifier must not be NIL.</p>
	TOSCMGMT	0 to 255 or \$	<p><i>From SCCP management message types</i> Enter one of the SCMG message types representing the end of the range of SCMG message types to which this rule applies. The value in subfield TOSCMGMT must be greater than the value in subfield FRSCMGMT.</p> <p>This field is only significant if the subsystem number of the CDPA being screened is 1 (SCMG). If the subsystem number is other than 1, enter \$.</p>
	RESULT	see subfield	<p><i>Screening result</i> This field consists of subfield NEXTFN.</p>

C7CDPA (continued)

Field descriptions (Sheet 5 of 5)

Field	Subfield or refinement	Entry	Explanation and action
REMARKS	NEXTFN	C7AFTPC or STOP	<i>Next screening function</i> Enter the next screening function to be performed. If subfield NEXTFN contains an entry other than STOP, and the subsystem number of the message is 1, enter C7AFTPC and datafill refinement NEXTREF. Enter STOP if the subsystem number is not equal to 1. No additional refinements require datafill.
	NEXTREF	alphanumeric	<i>Next screening reference</i> If subfield NEXTFN contains C7AFTPC, enter the value that designates the next screening function to be performed in field REFERENCE of table C7AFTPC.
		alphanumeric (1 to 8 characters)	<i>Remarks</i> This field is specified by the operating company and can be used to identify the name of the network or carrier to which the link is connected. Any eight-character value can be stored in this field. Avoid the use of special characters, such as +, *, /, -, and %.
	OPTIONS	see subfields	<i>Options</i> This field is used to specify screening options. It consists of subfield OPTNAME.
	OPTNAME	\$	<i>Option name</i> Enter \$, which is the only valid entry.

Datafill example

The following example shows sample datafill for table C7CDPA.

For each of the rules, if the screening rule matches the message being screened, then screening is finished and the call is routed normally, otherwise, the call is discarded.

C7CDPA (continued)**MAP display example for table C7CDPA**

SCRNREF	SCRNRULE	REMARKS
OPTIONS		
REF8 0	ANSI7 (245) \$ (245) \$ (1) \$ (1) \$ (1) \$ (255) \$ C7AFTPC	REF9 \$
\$		
REF8 1	ANSI7 (245) \$ (245) \$ (251) \$ (251) \$ \$ \$ STOP	\$
\$		
REF8 2	ANSI7 (5) \$ (5) \$ (251) \$ (251) \$ \$ \$ STOP	\$
\$		
REF8 3	ANSI7 (4) \$ (4) \$ (251) \$ (251) \$ \$ \$ STOP	\$
\$		
REF8 4	ANSI7 (0) \$ (0) \$ (251) \$ (251) \$ \$ \$ STOP	\$
\$		

Table history**STP04.0**

Removed references to MDR7 screening.

CSP06

Information removed about bulk deletion workaround.

CSP02

Information added about the possibility of service degradation if gateway screening is not turned off.

BCS36

Information added about bulk deletions.

Supplementary information

This section provides information on datafilling table C7CDPA for specific applications.

C7CDPA (end)

Datafill modifications



DANGER

Risk of service degradation

A service degradation can occur if gateway screening is not turned off in table C7GTWLKS prior to making additions, deletions, or changes to table C7CDPA.

The previous table control warning is displayed at the MAP display if a user attempts to add, change, or delete tuples in table C7CDPA.

A similar message is displayed in all the gateway screening tables (C7AFTPC, C7ALWDPC, C7ALWGTT, C7ALWOPC, C7ALWSIO, C7BLKDPC, C7BLKOPC, C7BLKSIO for CCITT only, C7CDPA, C7CGPA, and C7DSTFLD).

Note: The VERIFY function must be turned on. If VERIFY is off, the previous warning is not displayed.

C7CGPA

Table name

CCS7 Gateway STP SCCP Calling Party Address Screening Table

Functional description

Table C7CGPA defines the gateway screening functions for the signaling connection control part (SCCP) calling party address (CGPA). Each screening function consists of a set of up to 256 individual screening rules. Each screening rule can have a different screening result.

Note: All references to signaling transfer point (STP) are applicable to the STP/Service Switching Point (SSP) Integrated Nodes (INode), unless otherwise specified.

For related information, refer to table C7GTWLKS.

Datafill sequence and implications

The following tables (if required) must be datafilled before table C7CGPA:

- C7ALWGTT
- C7CDPA

The following tables (if required) must be datafilled after table C7CGPA:

- C7ALWDPC
- C7ALWOPC
- C7ALWSIO
- C7BLKDPC
- C7BLKOPC

Table size

32 767 tuples

Up to 400 tuples

The limit of 400 tuples for this table depends on the datafill in the other gateway screening tables.

The limit of 32 767 tuples for this table depends on the datafill in the other gateway screening tables. There are a maximum of 32 767 possible screening rules for all of the gateway tables (except table C7GTWLKS), therefore, the

C7CGPA (continued)

maximum number of tuples for the tables is 32 767 with the following restrictions:

- up to 1024 screening references for all tables
- up to 256 rules for each screening reference

Datafill

The following table lists datafill for table C7CGPA.

Field descriptions (Sheet 1 of 2)

Field	Subfield or refinement	Entry	Explanation and action
SCRNREF		see subfields	<i>Screening reference</i> This field is the key to the table and consists of subfields REFERNCE and RULENO.
	REFERNCE	alphanumeric (1 to 4 characters)	<i>Screening reference</i> Enter a value that uniquely identifies a calling party address (CGPA) screening function.
	RULENO	0 to 255	<i>Rule number</i> Enter a number to identify a rule in a screening function. Each screening function can consist of up to 256 distinct rules.
SCRNRULE		see subfield	<i>Screening rule</i> This field contains all the screening rule information and consists of subfield NETTYPE.

C7CGPA (continued)

Field descriptions (Sheet 2 of 2)

Field	Subfield or refinement	Entry	Explanation and action
	NETTYPE	ANSI7, CCITT7, or NTC7	<p><i>Network type</i> Enter the network type of the screening rule.</p> <p>Enter ANSI7 if the point codes screened are in American National Standards Institute (ANSI) format. Datafill refinements FROMPC, TOPC, FROMSSN, TOSSN, FRMLKGRP, TOLKGRP, CDPARTG, and RESULT described in the following table..</p> <p>Enter CCITT7 if the point codes screened are in the CCITT format. Datafill refinements PCRANGE, FROMSSN, TOSSN, FRMLKGRP, TOLKGRP, CDPARTG, and RESULT described in the field descriptions table in Section “NETTYPE = CCITY”..</p> <p>Enter NTC7 if the point codes being screened are in NTC7 format. Datafill refinements FROMPC, TOPC, FROMSSN, TOSSN, FRMLKGRP, TOLKGRP, CDPARTG, and RESULT described in the following table..</p> <p>Note: All screening functions defined prior to the BCS30 release of this table are ANSI format.</p>

NETTYPE = ANSI7 and NTC7

If the entry in subfield NETTYPE is ANSI7 or NTC7, datafill refinements FROMPC and TOPC as described below, then datafill refinements FROMSSN, TOSSN, FRMLKGRP, TOLKGRP, CDPARTG, and RESULT described in the field descriptions table in Section “NETTYPE = ANSI7, CCITY and NTC7”..

C7CGPA (continued)

Field descriptions for conditional datafill (Sheet 1 of 2)

Field	Subfield or refinement	Entry	Explanation and action
	FROMPC	0 to 255	<p><i>From point code</i> For a NETTYPE of ANSI7, enter a full or partial originating point code (OPC) representing the start of the range of OPCs to which this rule applies. Up to three values can be datafilled. If less than three values are required, end the list with a \$.</p> <p>For a NETTYPE of NTC7, enter a full OPC representing the start of the range of OPCs to which the rule applies. The \$ (dollar sign) is not allowed.</p> <p>The value of field FROMPC must be less than or equal to the value in field TOPC.</p> <ul style="list-style-type: none"> • <i>Note:</i> The following additional restrictions are applied to each tuple only if they have the network type ANSI7 and if the Signaling, Engineering, and Administration System (SEAS) software is present in the STP: <ul style="list-style-type: none"> • The network identifier of fields FROMPC and TOPC must be in the range 1 to 255 (a value of 0 [zero] is not valid). • The point code range represented by fields FROMPC and TOPC can only be one of the following types of ranges: <ul style="list-style-type: none"> — a single point code — a range of or all of the point codes within a network cluster — a range of or all of the network clusters within a network identifier — a range of or all of the network identifiers within the entire range of point codes

C7CGPA (continued)

Field descriptions for conditional datafill (Sheet 2 of 2)

Field	Subfield or refinement	Entry	Explanation and action
	TOPC	0 to 255	<p><i>To point code</i> For a NETTYPE of ANSI7, enter a full or partial OPC representing the end of the range of OPCs to which this rule applies. Up to three values can be datafilled. If less than three values are required, end the list with a blank column and a \$.</p> <p>For a NETTYPE of NTC7, enter a full OPC representing the end of the range of OPCs to which the rule applies. The \$ (dollar sign) is not allowed.</p> <p>The value of field TOPC must be greater than or equal to the value in field FROMPC.</p> <ul style="list-style-type: none"> • <i>Note:</i> The following additional restrictions are applied to each tuple only if they have the network type ANSI7 and if the Signaling, Engineering, and Administration System (SEAS) software is present in the STP: <ul style="list-style-type: none"> • The network identifier of fields FROMPC and TOPC must be in the range 1 to 255 (a value of 0 [zero] is not valid). • The point code range represented by fields FROMPC and TOPC can only be one of the following types of ranges: <ul style="list-style-type: none"> — a single point code — a range of or all of the point codes within a network cluster — a range of or all of the network clusters within a network identifier — a range of or all of the network identifiers within the entire range of point codes

NETTYPE = CCITT7

If the entry in subfield NETTYPE is CCITT7, datafill refinement PCRANGE as described in the following table, then datafill refinements FROMSSN, TOSSN, FRMLKGRP, TOLKGRP, CDPARTG, and RESULT described in the field descriptions table in Section “NETTYPE = ANSI7, CCITY and NTC7..

C7CGPA (continued)**Field descriptions for conditional datafill (Sheet 1 of 2)**

Field	Subfield or refinement	Entry	Explanation and action
	PCRANGE	see subfield	<i>CCITT point code range</i> This field consists of subfield FORMAT.
	FORMAT	BASIC or INTL	<i>Format of CCITT point codes</i> If the point code used is international, enter INTL and its refinements. If the point code used is based on one field, enter BASIC and its refinements.
	FROMPC	0 to 16383 or see subfields	<i>From point code</i> If the entry in subfield FORMAT is BASIC, enter a full originating point code (OPC) representing the start of the range of OPCs to which this rule applies. If the entry in subfield FORMAT is INTL, this field consists of subfields FROMZONE, FROMAREA, and FRMPOINT. Separate each subfield with a single space. The value of field FROMPC must be less than or equal to the value in field TOPC.
	FROMZONE	0 to 7	<i>From zone</i> Enter a value in the field FROMZONE for the OPC to which this rule applies.
	FROMAREA	0 to 255	<i>From area</i> Enter a value in the field FROMAREA for the OPC to which this rule applies.
	FRMPOINT	0 to 7	<i>From point</i> Enter a value in the field FRMPOINT for the OPC to which this rule applies.
	TOPC	see subfields	<i>To point code</i> This field consists of subfields TOZONE, TOAREA, and TOPOINT. Separate each subfield with a single space. The value of field TOPC must be greater than or equal to the value in field FROMPC.
	TOZONE	0 to 7	<i>To zone</i> Enter a value in the field TOZONE for the OPC to which this rule applies.

C7CGPA (continued)**Field descriptions for conditional datafill (Sheet 2 of 2)**

Field	Subfield or refinement	Entry	Explanation and action
	TOAREA	0 to 255	<i>To area</i> Enter a value in the field TOAREA for the OPC to which this rule applies.
	TOPOINT	0 to 7	<i>To point</i> Enter a value in the field TOPOINT for the OPC to which this rule applies.

NETTYPE = ANSI7, CCITT7 and NTC7

For all network types, continue datafill with refinements FROMSSN, TOSSN, FRMLKGRP, TOLKGRP, CDPARTG, and RESULT as described in the following table.

Field descriptions (Sheet 1 of 3)

Field	Subfield or refinement	Entry	Explanation and action
	FROMSSN	0 to 255 or \$	<p><i>From subsystem number</i> Enter one of the subsystem numbers representing the start of the range of subsystem numbers to which this rule applies.</p> <p>The value in field FROMSSN must be less than the value in field TOSSN.</p> <p>If the rule includes all subsystem numbers, enter \$ (no subsystem numbers specified, a vector with no elements) in fields FROMSSN and TOSSN.</p>
	TOSSN	0 to 255 or \$	<p><i>To subsystem number</i> Enter one of the subsystem numbers representing the end of the range of subsystem numbers to which this rule applies.</p> <p>The value in field TOSSN must be greater than the value in field FROMSSN.</p> <p>If the rule includes all subsystem numbers, enter \$ (no subsystem numbers specified, a vector with no elements) in fields FROMSSN and TOSSN.</p>
	FROMMT	0 to 255 or \$	Entering datafill into subfield FROMMT does not affect system functionality in this software release.

C7CGPA (continued)

Field descriptions (Sheet 2 of 3)

Field	Subfield or refinement	Entry	Explanation and action
	TOMT	0 to 255 or \$	Entering datafill into subfield TOMT does not affect system functionality in this software release.
	FRMLKGRP	0 to 99 or \$	<p><i>From link group</i> Enter one of the link groups, representing the start of the range of link groups to which this rule applies. One of the values in the range, determined by fields FRMLKGRP and TOLKGRP, is datafilled field LINKGRP in table C7GTWLKS.</p> <p>The value in field FRMLKGRP must be less than the value in subfield TOLKGRP.</p> <p>If the rule includes all link groups, enter \$ (no subsystem numbers specified, a vector with no elements) in fields FRMLKGRP and TOLKGRP.</p>
	TOLKGRP	0 to 99 or \$	<p><i>To link group</i> Enter one of the link groups representing the end of the range of link groups to which this rule applies. One of the values in the range, determined by subfields FRMLKGRP and TOLKGRP, is datafilled in table C7GTWLKS, field LINKGRP.</p> <p>The value in field TOLKGRP must be greater than the value in field FRMLKGRP.</p> <p>If the rule includes all subsystem numbers, enter \$ (no subsystem numbers specified, a vector with no elements) in fields FROMSSN and TOSSN.</p>
	CDPARTG	RTALLRTGT orRTSS	<p><i>Called party address routing indicator</i> Enter one of the symbols representing the value of the called party address (CDPA) routing indicator for which this rule applies.</p> <p>RTALL means this rule applies to both routing indicators 0 and 1</p> <p>RTGT represents a routing indicator of 0 (route on a global title)</p> <p>RTSS represents a routing indicator of 1 (route on point code and subsystem number)</p>

C7CGPA (continued)

Field descriptions (Sheet 3 of 3)

Field	Subfield or refinement	Entry	Explanation and action
	RESULT	see subfield	<i>Screening result</i> This field is a two-part field. It specifies the next screening function invoked for messages that follow this rule. This field consists of subfield NEXTFN.
	NEXTFN	C7ALWGTT C7DPAORST OP	<i>Next screening function</i> Enter the next screening function to be performed. An entry of C7ALWGTT can only be specified if subfield CDPARTG contains RTGT. An entry of C7ALWGTT cannot be specified if subfield CDPARTG contains RTSS or RTALL. If the entry in subfield NEXTFN contains STOP, no additional refinements require datafill. If the entry in subfield NEXTFN contains any entry other than STOP, datafill refinement NEXTREF.
	NEXTREF	alphanumeric (1 to 4 characters)	<i>Next screening reference</i> If the entry in subfield NEXTFN is C7ALWGTT or C7DPA, enter the value in field REFERENCE of the screening table that was specified in subfield NEXTFN that designates the next screening function performed.
REMARKS		alphanumeric (1 to 8 characters)	<i>Remarks</i> This field is specified by the operating company and can be used to identify the name of the network or carrier to which the link is connected. Avoid the use of special characters, such as +, *, /, -, and %.
OPTIONS		see subfields	<i>Options</i> This field is used to specify CCS7 screening options. This field consists of subfield OPTNAME.
	OPTNAME	\$	<i>Option name</i> Enter \$, which is the only valid entry.

Datafill example

The following example shows sample datafill for table C7CGPA.

C7CGPA (continued)

MAP display example for table C7CGPA

SCRNREF	SCRNRULE	REMARKS
OPTIONS		
REF6 0	ANSI7 (250) \$ (250) \$ (253) \$ (253) \$ (9) \$ (18) \$ (0) \$ (0) \$	
	RTGT C7ALWGTT REF7	\$
		\$
REF6 1	ANSI7 (252) \$ (252) \$ (253) \$ (253) \$ (9) \$ (18) \$ (0) \$ (0) \$	
	RTGT C7ALWGTT REF7	\$
		\$
REF6 2	ANSI7 (247) \$ (247) \$ (253) \$ (253) \$ (9) \$ (18) \$ (0) \$ (0) \$	
	RTGT C7ALWGTT REF7	\$
		\$
REF6 3	ANSI7 (251) \$ (251) \$ (253) \$ (253) \$ (9) \$ (18) \$ (0) \$ (0) \$	
	RTGT C7ALWGTT REF7	\$
		\$
REF6 4	ANSI7 (249) \$ (249) \$ (253) \$ (253) \$ (9) \$ (18) \$ (0) \$ (0) \$	
	RTGT C7ALWGTT REF7	\$
		\$

Table history

STP4.0

Added fields FROMMT and TOMT.

Removed references to MDR7 screening.

CSP06

Information removed about bulk deletion workaround.

CSP02

Information added about the possibility of service degradation if gateway screening is not turned off.

BCS36

Refinement MAXOCTET removed. Information added about bulk deletions.

Supplementary information

This section provides information on modifying datafill in table C7CGPA.

Datafill modifications**DANGER****Risk of service degradation**

A service degradation can occur if gateway screening is not turned off in table C7GTWLKS prior to making additions, deletions, or changes to table C7CGPA.

The previous table control warning is displayed at the MAP display if a user attempts to add, change, or delete tuples in table C7CGPA.

A similar message is displayed in all the gateway screening tables (C7AFTPC, C7ALWDPC, C7ALWGTT, C7ALWOPC, C7ALWSIO, C7BLKDPC, C7BLKOPC, C7BLKSIO for CCITT only, C7CDPA, C7CGPA, and C7DSTFLD).

Note: The VERIFY function must be turned on. If VERIFY is off, the above warning is not displayed.

C7CNGSTN

Table name

Common Channel Signaling 7 Congestion Threshold Table

Functional description

Table C7CNGSTN provides a number of sets of congestion threshold values. A set of default values, used to select thresholds for use on the signaling links in the linkset, is added to the table at loadbuild. Routeset management reacts to congestion levels whenever thresholds are crossed.

One of two sets of default values is loaded into this table, depending on whether the network served is inside or outside North America (international).

Table C7CNGSTN provides a number of sets of threshold values for three congestion levels. Each threshold level has three values: one for congestion onset, one for congestion abatement, and one for congestion discard. Each set of congestion levels consists of nine values. North American networks use all three levels of congestion. International networks with a network indicator of national and Australian national and international networks only use one level of congestion. One-level congestion networks do not need to specify a discard threshold.

Adding, modifying, and deleting threshold levels

Synchronized links, which select a congestion tuple that was added or modified, must be deactivated and activated again in order for the new congestion values to take effect.

Adding threshold levels

Select a previously undefined index. If the multiple congestion status (MCS [field MCS]) selected equals 3, nine threshold values for the network must be entered. If the MCS selected equals 1, two threshold values must be entered.

The rules for datafilling the nine values of the three levels congestion are summarized below. An illustration of these rules is presented in the following figure on the next page.

- The congestion abatement threshold must be less than the corresponding congestion onset threshold.
- The congestion abatement threshold n ($n = 2, 3$) must be greater than congestion onset threshold $n - 1$.
- The congestion discard threshold n ($n = 1, 2, 3$) must be greater than congestion onset threshold n .

C7CNGSTN (continued)

- The congestion discard threshold n ($n = 1, 2$) must be less than or equal to the congestion onset threshold $n + 1$.
- The congestion discard threshold n ($n = 1, 2$) must be less than or equal to the congestion abatement threshold $n + 1$.

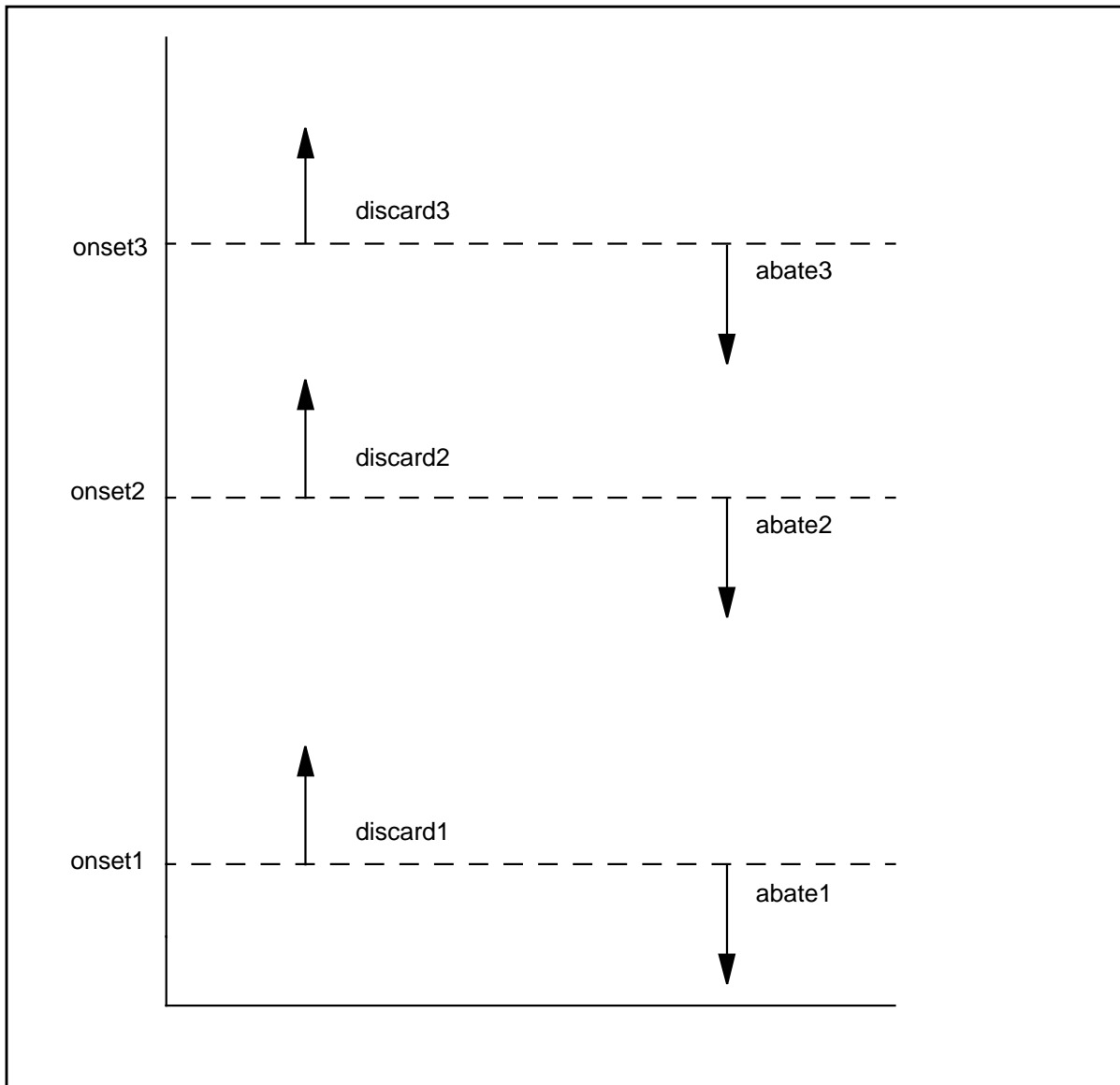
Commissioning rules for thresholds from the American National Standards Institute (ANSI) T1X1 Q.704 Section 3.6.2

For one level congestion status networks, datafill the two values that correspond to onset and abatement thresholds in the fields called ONSET and ABATE respectively.

C7CNGSTN (continued)**Modifying threshold values**

Threshold values can be modified without taking the referencing linksets offline.

Deleting threshold values

All linksets that have selected a particular set of thresholds must first be modified to select another set. Delete the set keyed by its index number in the table.

Default congestion values

A set of congestion values for a three-level congestion network is added to the first tuple of the congestion threshold table at loadbuild. For networks using non-ANSI types of Common Channel Signaling 7 (CCS7) signaling, a set of congestion values for a one-level network is added into the second tuple of the table at loadbuild.

All linksets initially use these tuples as default. The set of default congestion values for the network is shown in table Table , "xxDefault congestion values" on page -744. Buffering capacity is measured as a percentage of transmission and retransmission buffering space used in a signaling terminal.

xxDefault congestion values

Field name	Default value (in buffering capacity used)
ONSET	63%
ABATE	56%
ONSET1	38%
ABATE1	31%
DISCARD1	44%
ONSET2	63%
ABATE2	56%
DISCARD2	69%
ONSET3	88%
ABATE3	81%
DISCARD3	94%

C7CNGSTN (continued)

Tuple index 2 contains the default congestion values for linksets containing high-speed links. Table 2 shows the default datafill for tuple index 2.

Default congestion values for tuple index 2

Field name	Default value (in buffering capacity used)
ONSET1	17%
ABATE1	14%
DISCARD1	44%
ONSET2	49%
ABATE2	46%
DISCARD2	76%
ONSET3	82%
ABATE3	79%
DISCARD3	92%

If datafill exists in tuple index 2 prior to the one-night process (ONP) cutover to the new software load, the default values will not override the existing datafill. If tuple index 2 contains datafill prior to the ONP cutover, manually datafill an alternate index with the default datafill.

Datafill sequence and implications

There is no requirement to datafill other tables prior to table C7CNGSTN.

Table size

0 to 64 tuples

C7CNGSTN (continued)**Datafill**

The following table lists datafill for table C7CNGSTN.

Field descriptions (Sheet 1 of 6)

Field	Subfield or refinement	Entry	Explanation and action
CONGIDX		0 to 63	<p><i>Congestion table index</i></p> <p>Enter a congestion table index number from 2 to 63.</p> <p>The default value for a three-level network at loadbuild time is 0 (zero).</p> <p>The default value for a one-level network is 1.</p>
CONGEST		see subfield	<p><i>Congestion values</i></p> <p>This field consists of subfield MCS.</p>
	MCS	1 or 3	<p><i>Multiple congestion status</i></p> <p>Enter the number of congestion levels.</p> <p>Enter 3 for North American networks and datafill refinements ONSET and ABATE.</p> <p>Enter 1 for international networks with a network indicator of national and the Australian national and international networks and datafill refinements ONSET1, ABATE1, DISCARD1, ONSET2, ABATE2, DISCARD2, ONSET3, ABATE3, and DISCARD3.</p>
	ONSET	0 to 100	<p><i>Congestion onset threshold</i></p> <p>If the entry in subfield MCS is 1, enter the congestion onset threshold expressed as a percentage of buffer space.</p> <p>Log report CCS173, with congestion level equal to ONSET1, is output if the percentage of buffer space occupied increases to this value from a value less than the congestion abatement threshold value.</p> <p>The value in refinement ONSET must be greater than the value in refinement ABATE.</p>

C7CNGSTN (continued)

Field descriptions (Sheet 2 of 6)

Field	Subfield or refinement	Entry	Explanation and action
	ABATE	0 to 100	<p><i>Congestion abatement threshold</i></p> <p>If the entry in subfield MCS is 1, enter the congestion abatement threshold expressed as a percentage of buffer space.</p> <p>Log report CCS173, with congestion level equal to NONE, is output if the percentage of buffer space occupied decreases to this value after having exceeded the congestion onset threshold value.</p> <p>The value in refinement ABATE must be less than the value in refinement ONSET.</p> <p>No further datafill is required.</p> <p>Note: Each value entered in refinements ONSET, ABATE, ONSETn, ABATEn and DISCARDn (n = 1, 2, or 3) is expressed as a percentage of the total buffer capacity available for the transmission of CCS7 messages from the CCITT level 2 (not congestion level 2) to CCITT level 3 (not congestion level 3). In the DMS service switching point (SSP), the buffer capacity is 4096 bytes. The congestion level being datafilled then refers to the amount of this buffer space occupied for messaging, independent of the message length.</p>
	ONSET1	0 to 100	<p><i>Congestion onset threshold level one</i></p> <p>If the entry in subfield MCS is 3, enter the congestion onset threshold level one, expressed as a percentage of buffer space.</p> <p>Log report CCS173, with congestion level equal to ONSET1, is output if the percentage of buffer space occupied increases to this value from below the congestion abatement threshold level one value. The value in refinement ONSET1 must be greater than the value in refinement ABATE1.</p> <p>The value in refinement DISCARD1 must be greater than the value in refinement ONSET1 and must be less than the value in refinement ONSET2.</p>

C7CNGSTN (continued)

Field descriptions (Sheet 3 of 6)

Field	Subfield or refinement	Entry	Explanation and action
	ABATE1	0 to 100	<p><i>Congestion abatement threshold level one</i></p> <p>If the entry in subfield MCS is 3, enter the congestion abatement threshold level one, expressed as a percentage of buffer space.</p> <p>Log report CCS173, with congestion level equal to NONE, is output if the percentage of buffer space occupied decreases to this value after having exceeded the congestion onset threshold level one value.</p> <p>The value in refinement ABATE1 must be less than the value in refinement ONSET1.</p>
	DISCARD1	0 to 100	<p><i>Congestion discard threshold level one</i></p> <p>If the entry in subfield MCS is 3, enter the congestion discard threshold level one, expressed as a percentage of buffer space.</p> <p>Log report CCS173, with congestion level equal to DISCARD1, is output and all messages with priority 0 (zero) are discarded if the percentage of buffer space occupied increases to this value from the congestion onset threshold level one value.</p> <p>The value in refinement DISCARD1 must be greater than the value in refinement ONSET1 and must be less than the value in refinement ONSET2.</p>

C7CNGSTN (continued)

Field descriptions (Sheet 4 of 6)

Field	Subfield or refinement	Entry	Explanation and action
	ONSET2	0 to 100	<p><i>Congestion onset threshold level two</i></p> <p>If the entry in subfield MCS is 3, enter the congestion onset threshold level two, expressed as a percentage of buffer space.</p> <p>Log report CCS173, with congestion level equal to ONSET2, is output if the percentage of buffer space occupied increases to this value from below the congestion abatement threshold level two value.</p> <p>The value in refinement ONSET2 must be greater than the value in refinement ABATE2.</p> <p>The value in refinement DISCARD1 must be greater than the value in refinement ONSET1 and must be less than the value in refinement ONSET2.</p> <p>The value in refinement DISCARD2 must be greater than the value in refinement ONSET2 and must be less than the value in refinement ONSET3.</p>
	ABATE2	0 to 100	<p><i>Congestion abatement threshold level two</i></p> <p>If the entry in subfield MCS is 3, enter the congestion abatement threshold level two, expressed as a percentage of buffer space.</p> <p>Log report CCS173, with congestion level equal to DISCARD1, is output if the percentage of buffer space occupied decreases to this value after having exceeded the congestion onset threshold level two value.</p> <p>The value in refinement ABATE2 must be less than the value in refinement ONSET2.</p>

C7CNGSTN (continued)

Field descriptions (Sheet 5 of 6)

Field	Subfield or refinement	Entry	Explanation and action
	DISCARD2	0 to 100	<p><i>Congestion discard threshold level two</i></p> <p>If the entry in subfield MCS is 3, enter the congestion discard threshold level two, expressed as a percentage of buffer space.</p> <p>Log report CCS173, with congestion level equal to DISCARD2, is output and all messages with priorities 0 (zero) and 1 are discarded, if the percentage of buffer space occupied increases to this value, from the congestion onset threshold level two value.</p> <p>The value in refinement DISCARD2 must be greater than the value in refinement ONSET2 and must be less than the value in refinement ONSET3.</p>
	ONSET3	0 to 100	<p><i>Congestion onset threshold level three</i></p> <p>If the entry in subfield MCS is 3, enter the congestion onset threshold level three, expressed as a percentage of buffer space.</p> <p>Log report CCS173, with congestion level equal to ONSET3, is output if the percentage of buffer space occupied increases to this value from below the congestion abatement threshold level three value.</p> <p>The value in refinement ONSET3 must be greater than the value in refinement ABATE3.</p> <p>The value in refinement DISCARD2 must be greater than the value in refinement ONSET2 and must be less than the value in refinement ONSET3.</p> <p>The value in refinement DISCARD3 must be greater than the value in refinement ONSET3.</p>

C7CNGSTN (continued)**Field descriptions (Sheet 6 of 6)**

Field	Subfield or refinement	Entry	Explanation and action
	ABATE3	0 to 100	<p><i>Congestion abatement threshold level three</i></p> <p>If the entry in subfield MCS is 3, enter the congestion abatement threshold level three, expressed as a percentage of buffer space.</p> <p>Log report CCS173, with congestion level equal to DISCARD2, is output if the percentage of buffer space occupied decreases to this value after having exceeded the congestion onset threshold level three value.</p> <p>The value in refinement ABATE3 must be less than the value in refinement ONSET3.</p>
	DISCARD3	0 to 100	<p><i>Congestion discard threshold level three</i></p> <p>If the entry in subfield MCS is 3, enter the congestion discard threshold level three, expressed as a percentage of buffer space.</p> <p>Log report CCS173, with congestion level equal to DISCARD3, is output and all messages with priorities 0 (zero), 1, and 2 are discarded, if the percentage of buffer space occupied increases to this value, from the congestion onset threshold level three value.</p> <p>The value in refinement DISCARD3 must be greater than the value in refinement ONSET3.</p>

Datafill example

The following example shows the datafill for table C7CNGSTN.

The example contains three tuples. The first tuple shows the multiple congestion status of 3. The second tuple shows the multiple congestion status of 1. The third tuple is the default congestion tuple for linksets containing high-speed links.

C7CNGSTN (end)

MAP display example for table C7CNGSTN

CONGIDX		CONGEST								
0	3	38	31	44	63	56	69	88	81	94
1								1	63	56
2	3	17	14	44	49	46	76	82	79	92

C7DSTFLD

Table name

CCS7 Gateway STP Destination Field Screening Table

Functional description

Table C7DSTFLD specifies screening functions for the destination field of signaling network management (SNM) messages. This type of screening applies only to messages that have a service indicator (SI) of 0 and with the following message types:

- H0=0100 Transfer Prohibited (TFP, TCP), Transfer Allowed (TFA, TCA) and Transfer Restricted (TFR, TCR) messages
- H0=0101 Routeset Test (RSP, RCP, RSR, RCR) messages
- H0=0011 and H1=0010 Transfer Controlled (TFC) message

Messages that do not meet these criteria are not screened because they do not contain a Destination Point Code (DPC) field and messages are routed normally.

Note: All references to signaling transfer point (STP) are applicable to STP/Service Switching Point (SSP) Integrated Nodes (INode), unless otherwise specified.

For related information, refer to table C7GTWLKS.

Datafill sequence and implications

There is no requirement to datafill other tables prior to table C7DSTFLD.

The following tables (if required) must be datafilled after table C7DSTFLD:

- C7ALWDPC
- C7ALWOPC
- C7ALWSIO
- C7BLKSIO
- C7BLKDPC
- C7BLKOPC

Table size

32 767 tuples

C7DSTFLD (continued)

Up to 2000 tuples

The limit of 2000 tuples for this table depends on the datafill in the other gateway screening tables. There are a maximum of 2000 possible screening rules for all of the gateway tables (except table C7GTWLKS)

- The limit of 32 767 tuples for this table depends on the datafill in the other gateway screening tables. There are a maximum of 32 767 possible screening rules for all of the gateway tables (except table C7GTWLKS), therefore the maximum number of tuples for the tables is 32 767 with the following restrictions:
- up to 1024 screening references for all tables
- up to 256 rules for each screening reference

Datafill

The following table lists datafill for table C7DSTFLD.

Field descriptions (Sheet 1 of 2)

Field	Subfield or refinement	Entry	Explanation and action
SCRNREF		see subfields	<i>Screening reference</i> This field is the key to the table and consists of subfields REFERNCE and RULENO.
	REFERNCE	alphanumeric (1 to 4 characters)	<i>Screening reference</i> Enter a value that identifies an SNM destination field screening function.
	RULENO	0 to 255	<i>Rule number</i> Enter a number to identify a rule in a screening function. Each screening function can consist of up to 256 distinct rules.

C7DSTFLD (continued)**Field descriptions (Sheet 2 of 2)**

Field	Subfield or refinement	Entry	Explanation and action
SCRNRULE		see subfield	<i>Screening rule</i> This field contains all the screening rule information and consists of subfield NETTYPE.
	NETTYPE	ANSI7, CCITT7, or NTC7	<p><i>Network type</i>Enter the network type of the screening rule.</p> <p><i>Network type</i>Enter the network type of the screening rule.</p> <p>Enter ANSI7 if the point codes being screened are in ANSI format. Datafill refinements FROMPC, TOPC, and RESULT described in the following table.</p> <p>Enter CCITT7 if the point codes screened are in the CCITT format. Datafill refinements PCRANGE and RESULT described in the field descriptions table in Section "NETTYPE = CCITT7"..</p> <p>Enter NTC7 if the point codes screened are in the NTC7 format. Datafill refinements FROMPC, TOPC, and RESULT described in the following table..</p> <p>Note: Each rule of a screening function must be of the same network type. The network type of a screening function cannot be changed.</p>

NETTYPE = ANSI7 and NTC7

If the entry in subfield NETTYPE is ANSI7 or NTC7, datafill refinements FROMPC and TOPC as described in the following table, then datafill refinement RESULT as described in the field descriptions table in Section "NETTYPE = ANSI7, CCITT7 and NTC7"..

C7DSTFLD (continued)**Field descriptions for conditional datafill**

Field	Subfield or refinement	Entry	Explanation and action
	FROMPC	0 to 255	<p><i>From point code</i> For a NETTYPE of ANSI7, enter a full or partial DPC representing the start of the range of DPCs to which this rule applies. Up to three values can be datafilled. If less than three values are required, end the list with a \$.</p> <p>For a NETTYPE of NTC7, enter a full Originating Point Code (OPC) representing the start of the range of OPCs to which the rule applies. The \$ (dollar sign) is not allowed.</p> <p>The value of field FROMPC must be less than or equal to the value in field TOPC.</p>
	TOPC	0 to 255	<p><i>To point code</i> For a NETTYPE of ANSI7, enter a full or partial DPC representing the end of the range of DPCs to which this rule applies. Up to three values can be datafilled. If less than three values are required, end the list with a blank column and a \$.</p> <p>For a NETTYPE of NTC7, enter a full OPC representing the end of the range of OPCs to which the rule applies. The \$ (dollar sign) is not allowed.</p> <p>The value of field TOPC must be greater than or equal to the value in field FROMPC.</p>

NETTYPE = CCITT7

If the entry in subfield NETTYPE is CCITT7, datafill refinement PCRANGE as described below, then datafill refinement RESULT described in the field descriptions table in Section “NETTYPE = ANSI7, CCITY7 and NTC7”..

C7DSTFLD (continued)**Field descriptions for conditional datafill (Sheet 1 of 2)**

Field	Subfield or refinement	Entry	Explanation and action
	PCRANGE	see subfield	<i>CCITT point code range</i> This field consists of subfield FORMAT.
	FORMAT	BASICorINTL	<i>Format of CCITT point codes</i> If the point code used is international, enter INTL and its refinements. If the point code used is based on one field, enter BASIC and its refinements.
	FROMPC	0 to 16383orsee subfields	<i>From point code</i> If the entry in subfield FORMAT is BASIC, enter a full DPC representing the start of the range of DPCs to which this rule applies. If the entry in subfield FORMAT is INTL, this field consists of subfields FROMZONE, FROMAREA, and FRMPOINT. Separate each subfield with a single space. The value of field FROMPC must be less than or equal to the value in field TOPC.
	FROMZONE	0 to 7	<i>From zone</i> Enter a value in the FROMZONE field of the DPC to which this rule applies.
	FROMAREA	0 to 255	<i>From area</i> Enter a value in the FROMAREA field of the DPC to which this rule applies.
	FRMPOINT	0 to 7	<i>From point</i> Enter a value in the FRMPOINT field of the DPC to which this rule applies.
	TOPC	see subfields	<i>To point code</i> This field consists of subfields TOZONE, TOAREA, and TOPOINT. Separate each subfield with a single space. The value of field TOPC must be greater than or equal to the value in field FROMPC.
	TOZONE	0 to 7	<i>To zone</i> Enter a value in the TOZONE field for the DPC to which this rule applies.

C7DSTFLD (continued)

Field descriptions for conditional datafill (Sheet 2 of 2)

Field	Subfield or refinement	Entry	Explanation and action
	TOAREA	0 to 255	<i>To area</i> Enter a value in the TOAREA field for the DPC to which this rule applies.
	TOPOINT	0 to 7	<i>To point</i> Enter a value in the TOPOINT field for the DPC to which this rule applies.

NETTYPE = ANSI7, CCITT7, and NTC7

For all network types, continue datafill with refinement RESULT as described in the following table.

Field descriptions

Field	Subfield or refinement	Entry	Explanation and action
	RESULT	see subfields	<i>Screening result</i> This field is a two-part field. It specifies the next screening function invoked for messages that follow this rule. This field consists of subfield NEXTFN.
	NEXTFN	STOP	<i>Next screening function</i> Enter STOP to stop the screening function.
REMARKS		alphanumeric (1 to 8 characters)	<i>Remarks</i> This field is specified by the operating company and can be used to identify the name of the network or carrier to which the link is connected. Avoid the use of special characters, such as +, *, /, -, and %.
OPTIONS		see subfields	<i>Options</i> This field is used to specify CCS7 screening options. This field consists of subfield OPTNAME.
	OPTNAME	\$	<i>Option name</i> Enter \$, which is the only valid entry.

Datafill example

The following example shows sample datafill for table C7DSTFLD.

C7DSTFLD (continued)**MAP display example for table C7DSTFLD**

SCRNREF	OPTIONS	SCRNRULE	REMARKS
REFA 0	ANSI7 (245) (1) (0)\$ (245) (1) (0)\$	STOP	\$
\$			
REFA 1	ANSI7 (245) (2) (0)\$ (245) (2) (0)\$	STOP	\$
\$			
REFA 2	ANSI7 (245) (206) (1)\$ (245) (206) (1)\$	STOP	\$
\$			
REFA 3	ANSI7 (245) (206) (3)\$ (245) (206) (4)\$	STOP	\$
\$			
REFA 4	ANSI7 (245) (215) (2)\$ (245) (215) (2)\$	STOP	\$
\$			

Table history**STP04.0**

Removed references to MDR7 screening.

CSP06

Information removed about bulk deletion workaround.

CSP02

Information added about the possibility of service degradation if gateway screening is not turned off.

BCS36

Information added about bulk deletions.

Supplementary information

This section provides information on modifying datafill in table C7DSTFLD.

C7DSTFLD (end)

Datafill modifications



DANGER

Risk of service degradation

A service degradation can occur if gateway screening is not turned off in table C7GTWLKS prior to making additions, deletions, or changes to table C7DSTFLD.

The previous table control warning is displayed at the MAP display if a user attempts to add, change, or delete tuples in table C7DSTFLD.

A similar message is displayed in all the gateway screening tables (C7AFTPC, C7ALWDPC, C7ALWGTT, C7ALWOPC, C7ALWSIO, C7BLKDPC, C7BLKOPC, C7BLKSIO for CCITT only, C7CDPA, C7CGPA, and C7DSTFLD).

Note: The VERIFY function must be turned on. If VERIFY is off, the above warning is not displayed.

C7GATEPC

Table name

CCS7 Gateway Point Code Table

Functional description

ATTENTION

Feature 59009748 (C7GATEPC/C7GATERS Removal Feature) removes the functionality provided by table C7GATEPC. Table C7GATEPC must be empty.

If you try to create a tuple in table C7GATEPC, the system displays the following error message:

```
*****WARNING*****WARNING*****
C7GATEPC/C7GATERS (TEL00005) functionality has been replaced.
Table C7GATEPC is no longer supported in CSP12 or higher.
Adding new tuple to this table is not allowed.
```

```
*****WARNING*****WARNING*****
```

If you try to perform a table transfer process (TABXFR) during a software upgrade and table C7GATEPC is not empty, the system displays the following error message:

```
*****WARNING*****WARNING*****
C7GATEPC/C7GATERS (TEL00005) functionality has been replaced.
Table C7GATEPC is no longer supported in CSP12 or higher.
```

Please delete all datafill in Table C7GATEPC before performing TABXFR.

```
*****WARNING*****WARNING*****
```

C7GATEPC (end)

If you try to perform a table auditing step (command TABAUDIT) and table C7GATEPC is not empty, the system displays the following error message:

```
*****WARNING*****WARNING*****
```

```
C7GATEPC/C7GATERS (TEL00005) functionality has been replaced.
```

```
Table C7GATEPC is no longer supported in CSP12 or higher.
```

```
Please delete all datafill in Table C7GATEPC before upgrading to CSP12 or higher.
```

```
*****WARNING*****WARNING*****
```

C7GATERS

Table name

CCS7 Gateway Routeset Table

Functional description

ATTENTION

Feature 59009748 (C7GATEPC/C7GATERS Removal Feature) removes the functionality provided by table C7GATERS. Table C7GATERS must be empty.

If you try to create a tuple in table C7GATERS, the system displays the following error message:

```
*****WARNING*****WARNING*****
```

```
C7GATEPC/C7GATERS (TEL00005) functionality has been replaced.
```

```
Table C7GATERS is no longer supported in CSP12 or higher.
```

```
Adding new tuple to this table is not allowed.
```

```
*****WARNING*****WARNING*****
```

If you try to perform a table transfer process (TABXFR) during a software upgrade and table C7GATERS is not empty, the system displays the following error message:

```
*****WARNING*****WARNING*****
```

```
C7GATEPC/C7GATERS (TEL00005) functionality has been replaced.
```

```
Table C7GATERS is no longer supported in CSP12 or higher.
```

```
Please delete all datafill in Table C7GATERS before performing TABXFR.
```

```
*****WARNING*****WARNING*****
```

C7GATERS (end)

If you try to perform a table auditing step (command TABAUDIT) and table C7GATERS is not empty, the system displays the following error message:

```
*****WARNING*****WARNING*****
```

```
C7GATEPC/C7GATERS (TEL00005) functionality has been replaced.
```

```
Table C7GATERS is no longer supported in CSP12 or higher.
```

```
Please delete all datafill in Table C7GATERS before upgrading to CSP12 or higher.
```

```
*****WARNING*****WARNING*****
```

C7GTT**Table name**

Common Channel Signaling No. 7 Global Title Translation (C7GTT) table

Functional description

Table C7GTT provides the mapping of the global title (GT) of a particular translation type to a CCS7 network address that the Message Transfer Point (MTP) and the Signaling Connection Control part (SCCP) use to route a message to its destination.

Datafill sequence and implications

Datafill tables C7NETSSN, C7GTTYPE, C7LOCSSN, and C7RPLSSN before table C7GTT.

Datafill the GTT name in table C7GTTYPE. Datafill all PCs and PCSSNs used in table C7GTT in table C7NETSSN. When a GTT results in two PCSSNs, replicate them in table C7LRPLSSN. If the entry in GTTRSLT (table C7GTT) is SSNONLY, datafill the subsystem name in table C7LOCSSN.

Field descriptions

The following table describes field names, subfield names, and valid data ranges for table C7GTT.

(Sheet 1 of 2)

Field	Subfield or refinement	Entry	Explanation and action
GTTKEY			GLOBAL TITLE KEY. This field consists of a 3-part key: GTTNAME, FROMDIG, and TODIG.
	GTTNAME	Up to 16 alphanumeric characters	GLOBAL TITLE NAME. Enter a global title name datafilled in table C7GTTYPE.
	FROMDIG	Up to 18 digits (0 to 9)	FROM DIGITS. Enter the lower boundary of the GT range. The number of datafillable digits depends on the GTT type listed in table C7GTTYPE.
	TODIG	Up to 18 digits (0 to 9)	TO DIGITS. Enter the upper boundary of the GT range. The number of datafillable digits depends on the GTT type listed in table C7GTTYPE.

C7GTT (continued)

(Sheet 2 of 2)

Field	Subfield or refinement	Entry	Explanation and action
GTRSLT			GLOBAL TITLE RESULTS. Datafill the RESULT subfield.
	RESULT	ERROR,PCONLY SSNONLYPCSSN ,PCNEWGT,NEW GT	<p>RESULT. This field contains the result of a GT translation. Enter one of the following:</p> <ul style="list-style-type: none"> • PCONLY - point code only; datafill the refinements in the RESULT=PCONLY section. • SSNONLY - subsystem number only; datafill the refinements in the RESULT=SSNONLY section. • PCSSN - point code subsystem number; datafill the refinements in the RESULT=PCSSN section. <p>Note: The UCS DMS-250 switch only supports PCONLY, SSNONLY, and PCSSN.</p>

RESULT=PCONLY

When RESULT=PCONLY, datafill the following refinements:

Field	Subfield or refinement	Entry	Explanation and action
PC_RESUL TS			POINT CODE RESULTS. Datafill the 2-part multiple consisting of: PCNAME and COST. Datafill up to 2 PC_RESULTS.
	PCNAME	Up to 16 alphanumeric characters	POINT CODE NAME. Enter the appropriate PCNAME (datafilled in table C7RTESET)
	COST	0 to 99	COST. Enter the appropriate cost.
ROUTING		GTSSN	ROUTING INDICATOR. Enter the routing indicator.
			Note: SSN is not supported on the UCS DMS-250.

C7GTT (continued)**RESULT=SSONLY**

When RESULT=SSONLY, datafill the following refinements:

Field	Subfield or refinement	Entry	Explanation and action
SSN_RES ULTS		Up to 16 alphanumeric characters	SUBSYSTEM NUMBER RESULTS. Enter an appropriate SSNAME.

RESULT=PCSSN

When RESULT=PCSSN, datafill the following refinements:

Field	Subfield or refinement	Entry	Explanation and action
PC_SSN_R ESULTS			SUBSYSTEM NUMBER RESULTS. Datafill the 3-part refinement: PCNAME, SSNAME, and COST. Enter up to two SSN_RESULTS.
	PCNAME	Up to 16 alphanumeric characters	POINT CODE NAME. Enter the appropriate PCNAME datafilled in table C7RTESET.
	SSNAME	Up to 16 alphanumeric characters	SUBSYSTEM NAME. Enter the appropriate SSNAME.
	COST	0 to 99	COST. Enter the appropriate cost.
ROUTING		GTSSN	ROUTING INDICATOR. Enter the routing indicator.

Datafill example

The following example shows datafill for table C7GTT.

C7GTT (end)

GTTKEY GTTRSLT

CAIN_CLID_GT 0 5 SSNOONLY (CAINTEST) \$

CAIN_CLID_GT 6 9 PCONLY C7RTESEL1 0 \$ GT

C7GTTDF

Table name

CCS7 Global Title Translation Delta File

Functional description

Table C7GTTDF reduces the recovery time of a signaling transfer point (STP) or an STP/service switching point (SSP) integrated node (INode). Faster recovery is possible because of a reduction in the time that the system requires to synchronize data in tables C7GTT and C7GTTYPE. Synchronization occurs during the return-to-service (RTS) process of one of the following peripheral modules:

- CCS7 link interface unit (LIU7)
- high-speed link interface unit (HLIU)
- high-speed link router (HSLR)

Table C7GTTDF contains a list of recent updates to tables C7GTT and C7GTTYPE. Synchronization is faster because the system downloads the recent updates and not the contents of tables C7GTT and C7GTTYPE.

Table C7GTTDF contains the following information:

- additions, changes, and deletions to table C7GTTYPE
- changes in translation type and range of translation digits in table C7GTT
- translation result records that changes in the translation type and the range of translation digits in table C7GTT create
- translation result records that tuple changes to table C7NETSSN create
- translation result records that tuple changes to table C7DCIS6 create

Table C7GTTDF is a read-only table. The system enters data in this table. Operating company personnel cannot edit this table. Operating company personnel can view the contents of the file.

The office parameter C7GTT_DELTA_FILE_ACTIVITY_STATE starts or stops the C7GTTDF table.

Datafill sequence and meaning

Operating company personnel cannot enter data in table C7GTTDF.

Table size

If office parameter C7GTT_DELTA_FILE_ACTIVITY_STATE is ON or INACTIVE, the table contains 4096 tuples.

C7GTTDF (continued)

If office parameter `C7GTT_DELTA_FILE_ACTIVITY_STATE` is OFF, the table contains 1 tuple.

Datafill

Datafill for table `C7GTTDF` appears in the following table.

Field descriptions

Field	Subfield or refinement	Entry	Description
DFKEY		C7GTT-DF_KEY	<i>Delta file key</i> This field contains subfield INDEX.
	INDEX	numeric (0 to 4095)	<i>Index of DFKEY</i> This subfield identifies the index of the tuple of the table.
ACTION		ADD, MODIFY, or DELETE	<i>Action</i> This field identifies the action associated with the delta file entry.
UPINDEX		numeric (0 to 4095)	<i>Update index</i> This field identifies the entry in the table that contains the most recent addition to the delta file.
UPDDATA		C7_GTT_DF_RECTYPE_AREA	<i>Update data</i> This field identifies the content of the delta file update.
	RECTYPE	TRANSLATION_TYPE, RESULT, or DIGITS	<i>Record type</i> This field identifies the data type of the delta file entry. This field has multiple entries for subfields OLDTYPE and NEWTYPE.

C7GTTDF (continued)**RECTYPE = TRANSLATION_TYPE**

If the entry in field RECTYPE is TRANSLATION_TYPE, enter data in fields OLDTYPE, NEWTYPE, or TRANS and the associated subfields.

Field descriptions for conditional datafill (Sheet 1 of 4)

Field	Subfield or refinement	Entry	Explanation and Action
	OLDTYPE	see subfields	<p><i>Old translation type</i></p> <p>This subfield identifies the old translation type. This subfield contains the subfield NETWRK.</p> <p>The old translation type has an applied value if ACTION has an entry of MODIFY or DELETE.</p>
	NETWRK	CCITT7, ANSI7, NTC7, TTC7, or JPN7	<p><i>Network</i></p> <p>This subfield identifies the type of network.</p>
	GTNUM	numeric (0 to 255)	<p><i>Global title number</i></p> <p>If the entry in subfield NETWRK is CCITT7, ANSI7, or NTC7 the system enters data in this subfield. This subfield identifies the translation type number.</p>
	NA	NA_UN-KNOWN NA_SPA-RE_1, NA_SPA-RE_2, NATL, INTL, NA_SPA-RE_5, NA_SPA-RE_6, NA_SPA-RE_7,	<p><i>Nature of address</i></p> <p>If the entry in subfield NETWRK is CCITT7, ANSI7, or NTC7 the system enters data in this subfield. This subfield identifies the nature of the address type associated with the translation type.</p>

C7GTTDF (continued)**Field descriptions for conditional datafill (Sheet 2 of 4)**

Field	Subfield or refinement	Entry	Explanation and Action
	NP	NP_UN-KNOWN E164, NP_SPA-RE_2, NP_SPA-RE_3, NP_SPA-RE_4, NP_SPA-RE_5, E212, E214, NP_SPA-RE_8, NP_SPA-RE_9, NP_SPA-RE_A, NP_SPA-RE_B, NP_SPA-RE_C, NP_SPA-RE_D, NP_SPA-RE_E, or NP_SPA-RE_F	<i>Numbering plan</i> If the entry in subfield NETWK is CCITT7 or NTC7 the system enters data in this subfield. This subfield identifies the numbering plan associated with the translation type.
	NEWTYPE	see subfield	<i>New translation type</i> This field identifies the new translation type. This field contains the subfield NETWRK. The new translation type has an applied value if ACTION has an entry of MODIFY or DELETE.
	NETWK	CCITT7, ANSI7, NTC7, TTC7, or JPN7	<i>Network</i> This subfield identifies the type of network.
	GTNUM	numeric (0 to 255)	<i>Global title number</i> If the entry in subfield NETWK is CCITT7, ANSI7, or NTC7 the system enters data in this subfield. This subfield identifies the translation type number.

C7GTTDF (continued)**Field descriptions for conditional datafill (Sheet 3 of 4)**

Field	Subfield or refinement	Entry	Explanation and Action
	NA	NA_UN-KNOWN NA_SPA-RE_1, NA_SPA-RE_2, NATL, INTL, NA_SPA-RE_5, NA_SPA-RE_6, NA_SPA-RE_7,	<i>Nature of address</i> If the entry in subfield NETWK is CCITT7 or NTC7 the system enters data in this subfield. This subfield identifies the nature of the address type associated with the translation type.

C7GTTDF (continued)**Field descriptions for conditional datafill (Sheet 4 of 4)**

Field	Subfield or refinement	Entry	Explanation and Action
	NP	NP_UN-KNOWN E164, NP_SPA-RE_2, NP_SPA-RE_3, NP_SPA-RE_4, NP_SPA-RE_5, E212, E214, NP_SPA-RE_8, NP_SPA-RE_9, NP_SPA-RE_A, NP_SPA-RE_B, NP_SPA-RE_C, NP_SPA-RE_D, NP_SPA-RE_E, or NP_SPA-RE_F	<i>Numbering plan</i> If the entry in subfield NETWK is CCITT7 or NTC7 the system enters data in this subfield. This subfield identifies the numbering plan associated with the translation type.
	TRANS	ACCSGT, ACCTGT, AUTHGT, BNSGT, CNAMDGT, CORE, DIGSGT, E800BELL, E800ISDN, E800ITU, E800TELE, MAPISDN, NSSTCNGT, N00GT, OLNSGT, PHONY, PRAGT, PSTNGT, PVNGT, REPL, RTRSGT, TCNGT, ISDNSS, NIL_GT_ TRANS_NAME	<i>Translation name</i> The system enters the name of a user-defined translation type into this subfield. Table C7GTTYPE is the source for the user-defined translation type. If the user does not assign a name to the translation type, the system enters the value NIL_GT_TRANS_NAME into this subfield.

C7GTTDF (continued)**RECTYPE = DIGITS**

If the entry in field RECTYPE is DIGITS, enter data in fields GTTYPE, FRGIDS, TODIGS, GTRESLT and the associated subfields.

Field descriptions for conditional datafill (Sheet 1 of 2)

Field	Subfield or refinement	Entry	Explanation and Action
	GTTYPE	see subfields	<i>Global title type</i> This field identifies the translation type to which this update of digits applies.
	NETWK	CCITT7, ANSI7, NTC7, TTC7, or JPN7	<i>Network</i> This subfield identifies the type of network.
	GTNUM	numeric (0 to 255)	<i>Global title number</i> If the entry in subfield NETWK is CCITT7 or ANSI7, the system enters data in this subfield. This subfield identifies the translation type number.
	NA	NA_UN-KNOWN NA_SPA-RE_1, NA_SPA-RE_2, NATL, INTL, NA_SPA-RE_5, NA_SPA-RE_6, NA_SPA-RE_7,	<i>Nature of address</i> If the entry in subfield NETWK is CCITT7, the system enters data in this subfield. This subfield identifies the nature of the address type associated with the translation type.

C7GTTDF (continued)**Field descriptions for conditional datafill (Sheet 2 of 2)**

Field	Subfield or refinement	Entry	Explanation and Action
	NP	NP_UN-KNOWN E164, NP_SPA-RE_2, NP_SPA-RE_3, NP_SPA-RE_4, NP_SPA-RE_5, E212, E214, NP_SPA-RE_8, NP_SPA-RE_9, NP_SPA-RE_A, NP_SPA-RE_B, NP_SPA-RE_C, NP_SPA-RE_D, NP_SPA-RE_E, or NP_SPA-RE_F	<i>Numbering plan</i> If the entry in subfield NETWK is CCITT7, the system enters data in this subfield. This subfield identifies the numbering plan associated with the translation type.
	FRDIGS	numeric (1 to 18 digits)	<i>From digits</i> This field identifies the lower bound of the range of global titles.
	TODIGS	numeric (1 to 18 digits)	<i>To digits</i> This field identifies the upper bound of the range of global digits.
	GTRESLT	numeric (-32 768 to 32 767)	<i>Global title result</i> This field identifies the result table index for this translation.

C7GTTDF (continued)**RECTYPE = RESULTS**

If the entry in field RECTYPE is RESULTS, the system enters data in fields IDX, RESLT and EXTRESLT.

Field descriptions for conditional datafill

Field	Subfield or refinement	Entry	Explanation and Action
	IDX	numeric (-32 768 to 32 767)	<i>Result index</i> This field identifies the result table index for this translation.
	RESLT	20 numeric entries (0 to 255)	<i>Result</i> This field contains the result table that appears as a table of numbers.
	EXTRESLT	24 numeric entries (0 to 255)	<i>Extension result</i> This field contains the extension result table that appears as a table of numbers.

For RECTYPE values

For every field RECTYPE value, enter data in field UPDATKEY and the associated subfields.

Field descriptions (Sheet 1 of 2)

Field	Subfield or refinement	Entry	Explanation and Action
UPDATKEY		see subfields	<i>Update key</i> This field identifies the update key for this delta file entry. This field contains subfields SEQNUMBR and TIMESTMP.
	SEQNUMBR	see subfields	<i>Sequence number</i> This field identifies the sequence number. This field contains the subfields LSW, DIDW, and MSW.
	LSW	numeric (-32 768 to 32 767)	<i>Least significant word</i> This subfield identifies the least significant word of the sequence number.

C7GTTDF (continued)**Field descriptions (Sheet 2 of 2)**

Field	Subfield or refinement	Entry	Explanation and Action
	MIDW	numeric (-32 768 to 32 767)	<i>Middle word</i> This subfield identifies the middle word of the sequence number.
	MSW	numeric (-32 768 to 32 767)	<i>Most significant word</i> This subfield identifies the most significant word of the sequence number.
	TIMESTMP	see subfields	<i>Time stamp</i> This field identifies the time stamp for the delta file update. This field contains subfields LSW, DIDW, and MSW.
	LSW	numeric (-32 768 to 32 767)	<i>Least significant word</i> This subfield identifies the least significant word of the time stamp.
	MIDW	numeric (-32 768 to 32 767)	<i>Middle word</i> This subfield identifies the middle word of the time stamp.
	MSW	numeric (-32 768 to 32 767)	<i>Most significant word</i> This subfield identifies the most significant word of the time stamp.

Datafill example

The following examples show sample datafill for table C7GTTDF. The first example shows the datafill in table C7GTTDF when the parameter C7GTT_DELTA_FILE_ACTIVITY_STATE is OFF. There is 1 tuple in the table.

C7GTTDF (continued)**MAP example for table C7GTTDF**

DFKEY	ACTION	UPDINDEX	UPDATKEY				UPDDATA
0	ADD	0					
TRANSLATION_TYPE	CCITT7	0	NA_UNKNOWN	NP_UNKNOWN	CCITT7	0	NA_UNKNOWN
NP_UNKNOWN	NIL_GT_TRANS_NAME						
0	0	0	0	0	0	0	0

The second example shows part of the datafill in table C7GTTDF when the parameter C7GTT_DELTA_FILE_ACTIVITY_STATE is ON, but there have been no updates. There are 4096 tuples in the table.

MAP example for table C7GTTDF

DFKEY	ACTION	UPDINDEX	UPDATKEY				UPDDATA
0	ADD	0					
TRANSLATION_TYPE	CCITT7	0	NA_UNKNOWN	NP_UNKNOWN	CCITT7	0	NA_UNKNOWN
NP_UNKNOWN	NIL_GT_TRANS_NAME						
0	0	0	0	0	0	0	0
1	ADD	0					
TRANSLATION_TYPE	CCITT7	0	NA_UNKNOWN	NP_UNKNOWN	CCITT7	0	NA_UNKNOWN
NP_UNKNOWN	NIL_GT_TRANS_NAME						
0	0	0	0	0	0	0	0
2	ADD	0					
TRANSLATION_TYPE	CCITT7	0	NA_UNKNOWN	NP_UNKNOWN	CCITT7	0	NA_UNKNOWN
NP_UNKNOWN	NIL_GT_TRANS_NAME						
0	0	0	0	0	0	0	0

The third example shows part of the datafill in table C7GTTDF when the parameter C7GTT_DELTA_FILE_ACTIVITY_STATE is ON, but there are

C7GTTDF (continued)

only three updates in the table. There are 4096 tuples in the table. This table shows the following information:

- The first tuple:
 - A translation (digits) deletion occurs in the ANS17 network.
 - The global title number is 230.
 - The FROM digits are 91657268. The TO digits are 91657268.
 - The result is 32767.
 - This number is change number 20480 because the Delta File is ON.
 - The time stamp of the change is 21999 8221 572.
- The second tuple:
 - A translation (digits) addition occurs in the ANS17 network.
 - The global title number is 230.
 - The FROM digits were 91657268. The TO digits are 91657268.
 - The result is 253.
 - This number is change number 20481 because the Delta File is ON.
 - The time stamp of the change is 23932 8221 572.
- The third tuple:
 - A translation (digits) addition occurs in the ANS17 network.
 - The global title number is 230.
 - The FROM digits were 91657333. The TO digits are 91657333.
 - The result is 32767.
 - This number is change number 20482 because the Delta File is ON.
 - The time stamp of the change is 27094 8221 572.

C7GTTDF (end)**MAP example for table C7GTTDF**

DFKEY	ACTION	UPDINDEX									UPDDATA
			UPDATKEY								
0	DELETE	833									
DIGITS	ANSI7	230	916957268	916957268	32767	20480	0	0	21999	8221	572
1	ADD	833									
ANSI7	230	916957268	916957268	253	20481	0	0	23932	8221	572	
2	DELETE	833									
DIGITS	ANSI7	230	91657333	91657333	32767	20482	0	0	27094	8221	572

Table history**TL11**

Added high-speed link (HSL) references.

TL10

Added subfield TRANS for field RECTYPE=TRANSLATION_TYPR.

STP02

Table C7GTTDF was first released for STP02.

C7GTTYPE

Table name

Common Channel Signaling No. 7 Global Title Type (C7GTTYPE) table

Functional description

Table C7GTTYPE provides mapping of a Common Channel Signaling No. 7 (CCS7)-defined translation to a network-defined global title (GT) translation type value.

Datafill sequence and implications

Datafill table C7GTT after table C7GTTYPE.

Field descriptions

The following table describes field names, subfield names, and valid data ranges for table C7GTTYPE.

(Sheet 1 of 2)

Field	Subfield or refinement	Entry	Explanation and action
GTTNAME		Up to 16 alphanumeric characters	GLOBAL TITLE NAME. Enter the global title name.
GTTYPE		see subfields	GLOBAL TITLE TYPE. This field consists of one subfield (NETWK) and refinements.
	NETWK	ANSI7	C7 NETWORK TYPE. ANSI7 is the only supported network for UCS DMS-250. Datafill the GTNUM refinement. Note: CCITT7, TTC7, NTC7, and JPN7 are not supported.

C7GTTYPE (continued)

(Sheet 2 of 2)

Field	Subfield or refinement	Entry	Explanation and action
	GTNUM	0 to 255	GLOBAL TITLE NUMBER. Enter the global title number. Note: Nortel (Northern Telecom) recommends that the GTNUM match the SSNUMBER in table C7LOCSSN.
GTTID		N00GT, TCNGT, AUTHGT, ACCTGT, CAIN_CLID_GT, CAIN_ADDR_GT, CAIN_FEAT_GT, CAIN_OFCD_GT	GLOBAL TITLE IDENTIFICATION. Enter the global title. <ul style="list-style-type: none"> • N00GT-N00 subsystem (10 digits) • TCNGT-Travel Card subsystem (14 digits) • AUTHGT-Authcode Verification system (9 digits) • ACCTGT-Account Code subsystem (5 digits) • CAIN_CLID_GT- CAIN queries (10-digit ANI, 10-digit CLID, 3-digit SNPA) • CAIN_ADDR_GT- CAIN address (10 digits) • CAIN_FEAT_GT- SCP selector (1 to 5 digits) • CAIN_OFCD_GT- CAIN office code (10 digits)

Datafill example

The following example shows datafill for table C7GTTYPE.

GTTNAME	GTTTYPE	GTTID
N00GT	ANSI7 250 (N00GT) \$
CAIN_OFCD_GT	ANSI7 33 (CAIN_OFCD_GT) \$

C7GTTYPE (end)

Table history

UCS07

Field GTTID is modified to include N00GT, CAIN_FEAT_GT, and CAIN_OFCD_GT entries.

C7GTWLKS

Table name

CCS7 Gateway STP Linksets Screening Table

Overview

The CCS7 Gateway STP Screening Tables provide gateway signaling transfer point (STP) screening functions for the DMS-STP switch. The STP is a tandem message switch for Common Channel Signaling 7 (CCS7) networks.

Note: Every reference to signaling transfer point (STP) applies to the STP/Service Switching Point (SSP) Integrated Nodes (INode), unless indicated differently.

Common Channel Signaling 7

The CCS7 is a common channel signaling protocol. The CCS7 transfers circuit and noncircuit-related data in a telecommunications network.

The STP is a node in the CCS7 network. The STP performs the switching (or tandeming) of messages between other nodes in the CCS7 network.

The screening functions are for use in the American National Standards Institute (ANSI) variant of CCS7. Screening functions are available to provide for International Telecommunication Union (ITU) (previously CCITT) screening. The ITU screening is for the message transfer part (MTP), Signaling Network Management (SNM) and the telephone user part (TUP). Partial screening is available for ITU signaling connection control part (SCCP). The MTP screening includes the originating point code (OPC), the destination point code (DPC), and the service information octet (SIO). The SNM and TUP screening includes the H0 and H1 message codes.

Screening network types

The same screening tables define ANSI, ITU (previously CCITT), and NTC7 screening functions. To distinguish between the different types of screening functions, each rule within a table is assigned one of the three network types:

- ANSI7
- CCITT7
- NTC7

Gateway STP

An STP that provides connectivity between different CCS7 networks is called a gateway STP. A gateway STP allows one CCS7 network access to the resources of another network, such as databases. Added security is required at

C7GTWLKS (continued)

a gateway STP to guarantee that only authorized users receive access to a resource.

Gateway STP screening

Gateway STP screening allows the STP to discard messages from users that are not authorized. This action provides secure access between signaling points (SP) in a CCS7 network.

The gateway STP screens the following messages:

- the MTP and SCCP parts of the ANSI7 CCS7 messages
- the MTP and partial SCCP parts of CCITT7 CCS7 messages
- the MTP and SCCP parts of the NTC7 CCS7 messages

The switch can screen each CCS7 message received at the gateway STP on multiple requirements available through screening tables.

The MTP screening functions include:

- allowed originating point code (allowed OPC)
- blocked originating point code (blocked OPC)
- allowed destination point code (allowed DPC)
- blocked destination point code (blocked DPC)
- allowed service information octet (allowed SIO)
- blocked service information octet (blocked SIO) (not used for ANSI or NTC7 CCS7 messages)
- destination field of signaling network management (SNM) messages

The SCCP screening functions include:

- called party address (CDPA), not used for CCITT7 CCS7 messages
- calling party address (CGPA)
- global title translation (GTT) number
- affected point code and subsystem (PC/SSN), not used for CCITT7 CCS7 messages
- SCCP management (SCMG) messages, not used for CCITT7 CCS7 messages

For each linkset, the switch turns screening on or off through table C7GTWLKS. Screening tables define the separate screening functions. The

C7GTWLKS (continued)

switch performs screening functions before message routing in the following peripheral modules:

- CCS7 link interface units (LIU7)
- high-speed link interface units (HLIU)
- high-speed link routers (HSLR)

Gateway screening contains several separate screening functions that the switch performs on incoming messages. Each screening function applies to a specific field in the CCS7 message.

Screening functions are grouped into sets based on the field in the message that the switch screens. The gateway screening tables define these screening function sets. A screening function can initiate another screening function from a different set. The screening result rules in the following table make sure that no loops exist in a chain of screening functions.

Each screening function has one of the following results:

- **STOP**

The screening ends and the message proceeds with normal routing. This result must be entered in the screening table.
- **FAIL**

The screening function fails and the system discards the message. This result does not appear in the screening tables. For allowed screening functions, this is the default result when the screening rules do not match the message. For blocked screening functions, the switch uses this result when one of the screening rules matches the message.
- **CONTINUE**

The message passes the current screening function. Screening continues with the next screening function that appears in the screening tables. For the allowed screening functions, the screening rule that matches the message specifies the next function. For blocked screening functions, the default rule specifies the next function. The default rule applies when the other rules do not match the message.
- **ERROR**

The screening cannot proceed because of an error in the screening process. The system terminates screening and routes the message normally. This result cannot appear in the screening tables. This result can occur because of conditions that are not expected. An example of these conditions is SCCP screening on a message that is not an SCCP message. Changes to screening tables can correct this error.

C7GTWLKS (continued)

Tables that define the screening functions make sure that a strict ordering occurs on successive screening functions in the screening process. Each message can undergo each type of screening one time. The switch invokes the screening functions in the following order:

1. Allowed OPC
2. Blocked OPC
3. Allowed SIO
4. Blocked SIO (not used for ANSI CCS7 or NTC7 CCS7 messages)
5. Allowed DPC
6. Blocked DPC
7. Destination Field (SNM messages only)
8. CGPA (SCCP messages only)
9. GTT number (SCCP messages only)
10. CDPA (SCCP messages only) (not used for CCITT7 CCS7 messages)
11. Affected PC/SSN (SCMG messages only) (not used for CCITT7 CCS7 messages)

A screening function can only result in a screening function of a higher order. An allowed OPC screening function can result in continued CGPA screening. A CGPA screening function does not always result in OPC screening.

There are other limits on which screening functions can result in another function. The following table shows the possible results of the different screening functions.

For ANSI and NTC7 CCS7, valid results contain an A or •. These values are in the intersection of the screening function and the result in the following

C7GTWLKS (continued)

table . For CCITT CCS7, valid results contain a C or •. These values are in the intersection of the screening function and the result in the following table .

Correct screening table results

<i>Screening function</i>	Result												
	<i>C7</i>	<i>C</i>	<i>C7</i>	<i>C7</i>	<i>C7</i>	<i>C7</i>	<i>C7</i>	<i>C7</i>	<i>C7</i>	<i>C7</i>	<i>C7</i>	<i>ST</i>	<i>F</i>
	<i>A</i>	<i>B</i>	<i>A</i>	<i>B</i>	<i>A</i>	<i>B</i>	<i>D</i>	<i>C</i>	<i>A</i>	<i>C</i>	<i>A</i>	<i>O</i>	<i>AI</i>
	<i>L</i>	<i>C</i>	<i>L</i>	<i>L</i>	<i>L</i>	<i>L</i>	<i>ST</i>	<i>G</i>	<i>L</i>	<i>D</i>	<i>FT</i>	<i>P</i>	<i>L</i>
	<i>W</i>	<i>L</i>	<i>W</i>	<i>K</i>	<i>W</i>	<i>K</i>	<i>FL</i>	<i>P</i>	<i>W</i>	<i>P</i>	<i>P</i>		
	<i>O</i>	<i>K</i>	<i>SI</i>	<i>SI</i>	<i>D</i>	<i>D</i>	<i>D</i>	<i>A</i>	<i>G</i>	<i>A</i>	<i>C</i>		
	<i>P</i>	<i>O</i>	<i>O</i>	<i>O</i>	<i>P</i>	<i>P</i>			<i>TT</i>				
	<i>C</i>	<i>P</i>			<i>C</i>	<i>C</i>							
	<i>C</i>	<i>C</i>											
C7GTWLKS	•	•	•	C	•	•						•	
C7ALWOPC		•	•	C	•	•	•	A				•	
C7BLKOPC			•	C	•	•	•	A				•	•
C7ALWSIO				C	•	•	•	•		A		•	
C7BLKSIO					C	C	C					C	C
C7ALWDPC						•	•	A				•	
C7BLKDPC							•	A				•	•
C7DSTFLD												•	
C7CGPA									•	A		•	
C7ALWGTT										A		•	
C7CDPA											A	A	
C7AFTPC												A	

Screening tables

Each screening table contains a set of screening functions. All of the screening functions in a table screen the same field of a CCS7 message. All screening functions in the allowed OPC table (C7ALWOPC) screen on the OPC field of the message.

A four-character screening reference identifies each screening function in the table. Each screening function has a maximum of 256 different screening rules. A screening rule specifies a set of screening requirements, for example

C7GTWLKS (continued)

a range of point codes, and a result applied if the message being screened matches the screening criteria. Each screening rule is uniquely identified by its screening reference and a rule number (0 to 255). The set of all rules with the same reference in a screening table make up a screening function.

Each screening table can be an allowed or blocked screening table. The screening rules in allowed tables specify the values in the allowed CCS7 messages. If one of the screening rules in an allowed function matches the screened message, then the result of that screening rule is applied (either "stop" or "continue" with another screening function). If none of the screening rules in an allowed function matches the screened message, then it is assumed the message is not allowed and it is discarded. All screening tables, with the exception of C7BLKOPC, C7BLKDPC and C7BLKSIO, are of this type.

The screening rules in blocked tables specify the values in the CCS7 messages that are not allowed. Each function in a blocked screening table has a default rule. One of the screening rules in a blocked function can match the screened message. When this condition occurs, the system does not allow the message and discards the message. If the screening rules in a blocked function do not match the screened message, the switch applies the result of the default rule. This result is stop or continue with another screening function. The three screening tables of this type are C7BLKOPC, C7BLKDPC, and C7BLKSIO.

The gateway linkset table (C7GTWLKS) specifies the screening attributes of CCS7 linksets. This table specifies the first screening function applied to incoming messages. The first function can initiate additional screening functions. Each linkset can have a different set of screening functions. This table enables or disables screening on separate linksets. This table specifies log threshold values for the gateway screening logs for each linkset.

Screening in the LIU7 or HSLR for CCS7 messages

The following figure shows the path of CCS7 messages in the LIU7 or HSLR. A discrimination function handles incoming messages. This discrimination function determines if the message is for a local service or for another network node. The system passes messages, where the DPC is the point code (PC) or capability code of the STP, to the distribution function. The distributor examines the service information octet (SIO) to determine the local service for the message. The system passes messages with a service indicator of 0 to the signaling network management (SNM) function. The system passes messages with a service indicator of 3 to the signaling connection control part (SCCP) function. If global title translation (GTT) is required, the SCCP performs the GTT. The system routes the message to a local subsystem or to another network node through the MTP.

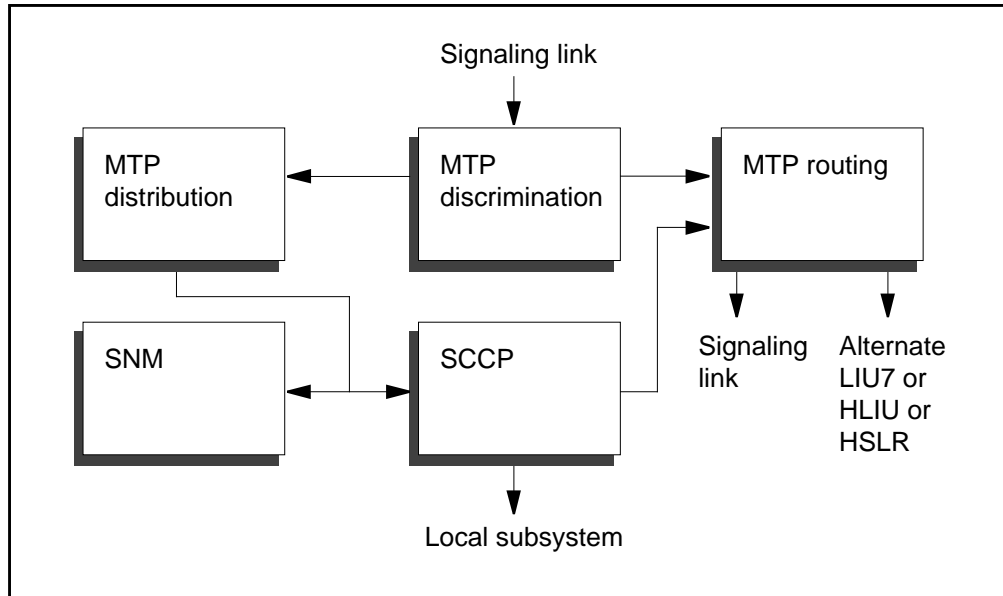
C7GTWLKS (continued)**Signaling functions in the LIU7 or HSLR for CCS7 messages****Screening functions in the LIU7, HLIU or HSLR for CCS7 messages**

The following figure shows where the gateway screening functions fit into the LIU7, HLIU, or HSLR. Two sets of functions are present. Datafill determines which function can be invoked.

The MTP screening functions include:

- Allowed OPC
- Blocked OPC
- Allowed DPC
- Blocked DPC
- Service Information Octet (SIO)
- Destination Field (DESTFLD) screening

The SCCP screening functions include:

- Called Party Address (CDPA)
- Calling Party Address (CGPA)
- Global Title Translation (GTT) number
- Affected Point Code (AFTPC) screening

C7GTWLKS (continued)

If MTP screening functions are required, the switch invokes these functions before the normal MTP discrimination function. The switch can invoke the SCCP screening from one of two locations. The switch distributes the message to the SCCP function in the LIU7 or HSLR, the SCCP invokes the appropriate SCCP screening functions. If the message does not require SCCP routing, the MTP discrimination function invokes the SCCP screening functions. This action occurs before the MTP discrimination function passes the message to the MTP routing function.

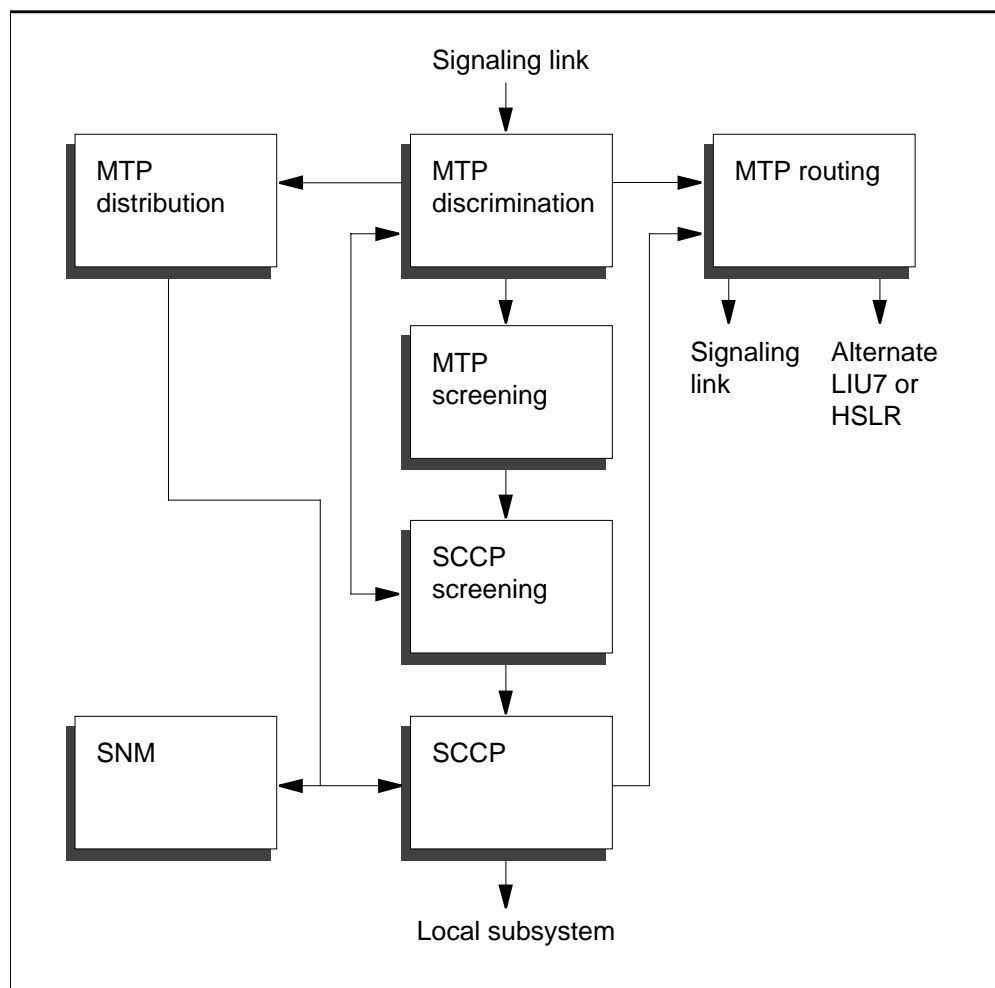
Screening functions in the LIU7, HILU or HSLR**Signaling Engineering Administration System (SEAS)**

The SEAS is a Bellcore specification that defines a protocol for central maintenance of the CCS7 network STP data. Gateway screening allows an STP to restrict access to services in the network to provide increased security. The system discards messages from users that are not authorized.

C7GTWLKS (continued)

Functional description

Table C7GTWLKS defines the gateway screening parameters that associate with a linkset. These parameters include the first screening function, the log report threshold values, and the operational measurement (OM) register sets.

The following rules apply:

- Only ANSI, CCITT, or NTC7 linksets can be entered in table C7GTWLKS. The entry in field FEPC in table C7LKSET specifies the network type.
- The entry in field RESULT can specify a screening function. When this condition occurs, the network type of that function must be the same as the network type of the linkset. Field FEPC in table C7LKSET specifies the network type.

Limits when SEAS Version 3.0 is on the DMS switch

The following limits apply to table C7GTWLKS when SEAS Version 3.0 is on the DMS-STP switch:

- Every tuple in table C7GTWLKS must have the same value in field SCRFAILS. Changes to this field in one tuple cause the equivalent changes in all other tuples. When the system adds a new tuple, the tuple must have the same value in field SCRFAILS as the current tuples.
- Every tuple in table C7GTWLKS must have the same value in field SCRERROR. Changes to this field in one tuple cause the equivalent changes in the other tuples. When the system adds a new tuple, the tuple must have the same value in field SCRERROR as the current tuples.
- The PERIOD values for fields MSUDSCRD and MSURECVD must be identical in a tuple. The LIMIT values in fields MSUDSCRD and MSURECVD can be different.

Datafill sequence and meaning

You must enter data in the following tables before you enter data in table C7GTWLKS:

- C7ALWOPC
- C7BLKOPC
- C7ALWSIO
- C7BLKSIO
- C7ALWDPC
- C7BLKDPC
- C7DSTFLD

C7GTWLKS (continued)

- C7CGPA
- C7ALWGTT
- C7CDPA
- C7AFTPC
- C7LKSET

Table size

256 tuples

108 tuples for a switch with the BRISC processor

72 tuples for a switch without the BRISC processor

Each linkset entered in table C7LKSET can have a corresponding entry in table C7GTWLKS. The maximum number of tuples in C7GTWLKS is the same as for table C7LKSET.

Datafill

Datafill for table C7GTWLKS appears in the following table.

Field descriptions (Sheet 1 of 8)

Field	Subfield or refinement	Entry	Description
LINKSET		see subfield	<i>Link set key</i> This field contains subfield LS_NAME.
	LS_NAME	alphanumeric (1 to 16 characters)	<i>Link set name</i> Enter the linkset name for which screening occurs. The linkset name is a vector that table C7LKSET defines.
ENABLED		Y or N	<i>Screening enabled</i> Enter Y (yes) if the switch activates gateway screening for this screening function when the data downloads to the LIU7 or HSLR. Otherwise, enter N (no). Note 1: Changes to the value of this field turns screening on or off without removal of datafill. Note 2: When SEAS is on the DMS-STP switch, this value defaults to Y.

C7GTWLKS (continued)**Field descriptions (Sheet 2 of 8)**

Field	Subfield or refinement	Entry	Description
SCREEN		see subfields	<i>Screening functions</i> This field contains subfield RESULT.
	RESULT	STOP C7ALWOPC C7BLKOPC C7ALWSIO C7BLKSIO C7ALWDPC C7BLKDPC	<i>Next result</i> Enter the type of screening that the switch performs next. If the entry is STOP, do not enter data in additional subfields. For all other entries, enter data in subfield NEXTREF.
	NEXTREF	alphanumeric (a maximum of 4 characters)	<i>Next screening reference</i> If the entry in field RESULT is not STOP, enter the value in field REFERNCE of the screening table specified in field RESULT. This entry designates the next screening function to perform. If the entry in subfield RESULT is STOP, leave subfield NEXTREF blank.
LINKGRP		0 to 99 or \$	<i>Link group ID</i> Enter a numeric link group ID to associate several linksets to a group for the CGPA (Calling Party Address) screening function. If the rule includes all link groups, enter \$.
MSUDSCRD		see subfield	<i>Message signal units discarded</i> This field refers to the number of MSUs a screening function discards. This field contains subfield CCS500ACT.

C7GTWLKS (continued)

Field descriptions (Sheet 3 of 8)

Field	Subfield or refinement	Entry	Description
	CCS500ACT	Y or N	<p><i>CCS500 log report activated</i></p> <p>The system can generate a CCS500 log each time the threshold limit is reached in successive time PERIODs. When this condition occurs, enter Y and enter data in subfields LIMIT and PERIOD.</p> <p>If the system does not generate a CCS500 log, enter N and leave subfields LIMIT and PERIOD blank.</p> <p>Note: When SEAS is on the DMS-STP switch, the default value for this field is N.</p>
	LIMIT	1 to 999 999	<p><i>Threshold limit</i></p> <p>If the entry in field CCS500ACT is Y, enter the number of MSUs that the system must discard, within the time period defined in field PERIOD, to generate a CCS500 log.</p> <p>If the entry in field CCS500ACT is N, leave the field blank.</p>
	PERIOD	5, 10, 15, 20, or 30	<p><i>Time period</i></p> <p>Entries outside this range are not valid. If the entry in field CCS500ACT is Y, enter the duration of the time period during which the value in field LIMIT is not to be exceeded. Enter the time in minutes. If the value in field LIMIT is reached or exceeded during the time period, the system generates a CCS500 log.</p> <p>If the entry in field CCS500ACT is N, leave the field blank.</p> <p>Note: When SEAS is on the DMS-STP switch, the PERIOD values for fields MSUDSCRD and MSURECVD must be the same.</p>
MSURECVD		see subfield	<p><i>Message signal units received</i></p> <p>This field refers to the number of MSUs received from other networks. This field contains subfield CCS501ACT.</p>

C7GTWLKS (continued)

Field descriptions (Sheet 4 of 8)

Field	Subfield or refinement	Entry	Description
	CCS501ACT	Y or N	<p><i>CCS501 log report activated</i></p> <p>The system can generate a CCS501 log each time the threshold limit is reached in successive time periods. When this condition occurs, enter Y and enter data in subfields LIMIT and PERIOD.</p> <p>If the system does not generate a CCS501 log, enter N. Leave subfields LIMIT and PERIOD blank.</p> <p>Note: When SEAS is on the DMS-STP switch, the default value for this field is N (not active).</p>
	LIMIT	1 to 999 999	<p><i>Threshold limit</i></p> <p>If the entry in field CCS501ACT is Y, enter the number of MSUs that the system must receive to generate a CCS501 log. The system must receive the MSUs within the time period defined in field PERIOD.</p> <p>If entry in field CCS501ACT is N, leave this field blank.</p>
	PERIOD	5, 10, 15, 20, or 30	<p><i>Time period</i></p> <p>Entries out of this range are invalid. If the entry in field CCS501ACT is Y, enter the time period during which the value in field LIMIT cannot be exceeded. The time in minutes. If the value in field LIMIT is reached or exceeded during the time period, the system generates a CCS501 log.</p> <p>If the entry in field CCS501ACT is N, leave this field blank.</p> <p>Note: When SEAS is on the DMS-STP switch, the PERIOD values for fields MSUDSCRD and MSURECVD must be the same.</p>

C7GTWLKS (continued)

Field descriptions (Sheet 5 of 8)

Field	Subfield or refinement	Entry	Description
SCRFAILS		see subfield	<p><i>Screening function failures</i></p> <p>This field refers to the number of CCS502 log reports required to reach the threshold value in field LIMIT. This requirement applies when the system does not generate more log reports until the end of the time PERIOD. The CCS502 logs report the number of MSUs that a screening function discards. This field contains subfield CCS502ACT.</p> <p>Note: When SEAS is on the DMS-STP switch, each tuple must have the same value in field SCRFAILS. Changes to this field in one tuple causes the equivalent change in the other tuples. When addition of a new tuple occurs, the tuple must have the same value in field SCRFAILS as the current tuples.</p>
	CCS502ACT	Y or N	<p><i>CCS502 log report activated</i></p> <p>The system generates log CCS502 to report the number of MSUs that a screening function discards. If the system generates this log, enter Y and enter data in fields LIMIT and PERIOD.</p> <p>If the system does not generate a CCS502 log, enter N. Leave fields LIMIT and PERIOD blank.</p> <p>Note: When SEAS is on the DMS-STP switch, the default value for this field is Y (active).</p>
	LIMIT	1 to 999 999	<p><i>Threshold limit</i></p> <p>If entry in field CCS502ACT is Y, enter the number of MSUs that must be discarded by a screening function during the time period specified by the entry in field PERIOD, to generate a CCS502 log report. When the number of MSUs discarded reach this threshold limit, one CCS502 log is generated and no further CCS502 logs are generated until the next time period.</p> <p>If entry in field CCS502ACT is N, leave field blank.</p> <p>Note: When SEAS is on the DMS-STP switch, the default value for this field is 10 (10 logs).</p>

C7GTWLKS (continued)

Field descriptions (Sheet 6 of 8)

Field	Subfield or refinement	Entry	Description
	PERIOD	5, 10, 15, 20, or 30	<p><i>Time period</i></p> <p>Entries out of this range are not valid. If the entry in field CCS502ACT is Y, enter the time period during which the value in field LIMIT cannot be exceeded. The time period is in minutes. If the the value in field LIMIT is reached or exceeded during the time period, the system generates one CCS502 log. The system does not generate more CCS502 logs until the next time period.</p> <p>If entry in field CCS502ACT is N, leave field blank.</p> <p>Note: When SEAS is on the DMS-STP switch, the default value for this field is 5 (5 min).</p>
SCRERROR		see subfield	<p><i>Screening function errors</i></p> <p>This field refers to the number of CCS503 log reports the system can generate. When the number of CCS503 log reports generated reaches the threshold value in field LIMIT, no further log reports are generated until the end of the time PERIOD. CCS503 logs are used to report the number of errors that have occurred in a screening function. This field consists of subfield CCS503ACT.</p> <p>Note: When SEAS is present on the DMS-STP switch, each tuple must have the same value in field SCRERROR. Changes to this field in one tuple causes the equivalent change in the other tuples. When addition of a new tuple occurs, the tuple must have the same value in field SCRERROR as the current tuples.</p>

C7GTWLKS (continued)

Field descriptions (Sheet 7 of 8)

Field	Subfield or refinement	Entry	Description
	CCS503ACT	Y or N	<p><i>CCS503 log report activated</i></p> <p>If the system generates a CCS503 log to report the number of errors that occur during a screening function, enter Y. Enter data in subfields LIMIT and PERIOD.</p> <p>If the system does not generate a CCS502 log, enter N. Leave fields LIMIT and PERIOD blank.</p> <p>Note: When SEAS is present on the DMS-STP switch, the default value for this field is Y (active).</p>
	LIMIT	1 to 999 999	<p><i>Threshold limit</i></p> <p>If the entry in field CCS503ACT is Y, enter the number of errors during a screening function that must occur during the time period that field PERIOD specifies to generate a CCS503 log report. When the number of errors during a screening function reaches this threshold limit, the system generates one CCS503 log. The system does not generate more CCS503 logs until the next time period.</p> <p>If entry in field CCS502ACT is N, leave field blank.</p> <p>Note: When SEAS is present on the DMS-STP switch, the default value for this field is 10 (10 logs).</p>
	PERIOD	5, 10, 15, 20, or 30	<p><i>Time period</i></p> <p>Entries outside this range are not valid. If the entry in field SCRERROR is Y, enter a value. This value specifies the time period during which the value in field LIMIT cannot be exceeded. The time period is in minutes. If the value in field LIMIT is reached or exceeded, during the time period, the system generates one CCS503 log. The system does not generate more CCS503 logs until the next time period.</p> <p>If entry in field CCS503ACT is N, leave field blank.</p> <p>Note: When SEAS is on the DMS-STP switch, the default value for this field is 5 (5 min).</p>

C7GTWLKS (continued)**Field descriptions (Sheet 8 of 8)**

Field	Subfield or refinement	Entry	Description
REMARKS		alphanumeric (1 to 8 characters)	<i>Remarks</i> The operating company specifies this field. This field can identify the name of the network or carrier to which the link connects. This field can store eight-character values. Avoid the use of special characters, such as +, *, /, -, and %.
OPTIONS		see subfields	<i>Options</i> Enter \$, which is the only valid entry.

Datafill example

The following example shows sample datafill for table C7GTWLKS.

The example defines the gateway STP screening parameters that associate with linkset LNKSET4. In this example:

- The screening is enabled.
- The next screening function to perform is identified in table C7ALWOPC, if the value in field REFERNCE is SCRN.
- The link group ID is 10.
- The CCS500 log is activated with a threshold limit of 100 and a period of 5 min. If 100 or more MSUs are discarded within the 5-min period, a CCS500 log is generated.
- The CCS501 log is activated with a threshold limit of 100 and a period of 5 min. If 100 or more MSUs are received within the 5-min period, a CCS501 log is generated.
- The CCS502 log is activated with a threshold limit of 100 and a period of 5 min. When the number of messages from other networks reaches 100 during the 5-min period, one CCS502 log is generated, and no additional CCS502 logs are generated until the next period.
- The CCS503 log is activated with a threshold limit of 100 and a period of 5 min. When the number of errors within a screening function reach 100 during the 5-min period, one CCS503 log is generated, and no additional CCS503 logs are generated until the next period.

C7GTWLKS (end)

MAP example for table C7GTWLKS

LINKSET	ENABLED				SCREEN			LINKGRP
MSUDSCRD	MSURECVD		SCRFAILS		SCRERROR		REMARKS	
OPTIONS								
LNKSET4			Y		C7ALWOPC	SCRN	(10)	\$
Y	100	5	Y	100	5	Y	100	5
	\$							\$

Table history

TL11

References to HLIU and HSLR were added.

STP04.0

References to MDR7 screening were removed in STP04.0.

C7ISL

Table name

C7 ISDN User Part Signaling Loopback

Functional description

Table C7ISL allows an operating company to define the two endpoints that makeup an ISL (ISUP Signaling Loopback) facility. The purpose of table C7ISL is to identify those ISUP facilities with ISL capabilities, and provide the digital trunk controller 7 (DTC7) XPM with the additional information needed to properly route the associated signaling messages.

Datafill sequence and implications

Table C7ISL is provisioned after C7TRKMEM in addition to normal ISUP datafill.

Table size

Table C7ISL utilizes SEGMENTED STORE to dynamically expand and contract as needed. The capacity of table C7ISL parallels that of table C7TRKMEM, and relies on sizing restrictions/limitations already defined for table C7TRMEM.

Datafill

The following table lists datafill for table C7ISL.

Datafill example

The following example shows sample datafill for table C7ISL.

MAP display example for table C7ISL

TABLE: C7ISL	
ENDPT 1	ENDPT 2
ICISL 1	OGISL 1

Table history

NA008

Added table C7ISL.

C7LINK

Table name

CCS7 Link Table

Functional description

Table C7LINK makes the association between the physical equipment of a link and the logical view of the link as a member of a set of links (a linkset). A link is composed of a signaling terminal (ST), transmission links (TL), and a message switch and buffers (MSB) and the logical view as a member of a set of links (a linkset).

Note: If office parameter USP_ACTIVE_IN_NETWORK is set to Y, you cannot access information in this table. A message appears referring you to the Graphical User Interface on the Universal Signaling Point (USP) for proper administration of link data.

CCS7 links that are associated with signaling transfer point (STP) logical nodes can be located on any link peripheral processor (LPP). For DMS-Service Switching Point (SSP) or Integrated Node (INode) offices, SSP links can reside on any of the following platforms:

- link peripheral processor (LPP)
- DMS SuperNode SE link interface shelf (SNSE LIS)
- fiber link interface shelf (FLIS)

Note 1: All references to the STP apply to the INode unless otherwise specified.

Note 2: Throughout this document, LIU (link interface unit) is used to refer to Common Channel Signaling 7 link interface units (LIU7), ethernet link interface units (ELIU) high-speed link interface units (HLIU), multiple link interface units (MLIU) and high-speed link routers (HSLR).

Table C7TRKMEM increased its limit to 120960 tuples in TL13 software release. To enable the increased limit, table C7LINK and C7ROUTER must datafill only 32-Mbyte LIU7s. The value of field PROCPEC for the LIU7 in table LIUINV must be set to NTEX22CA.

Datafill sequence and implications

The following tables must be datafilled before table C7LINK:

- C7NETWRK
- C7LKSET
- C7TIMER

C7LINK (continued)

- C7CNGSTN
- LIUINV
- STPOOLS
- STINV
- TRKMEM
- TRKGRP
- TRKSGRP
- ADJNODE
- CLLI

When provisioning HSL, datafill tables C7LKPARAM and CARRMTC.

Table size

Up to 108 tuples for a switch with the Nortel reduced instruction set computing (BRISC) processor

Up to 180 tuples for a switch with the BRISC processor if the following conditions are met:

- The software load is a World Trade or GSM product.
- There are no T1 digital trunk controllers (DTC) datafilled in table LTCINV (LIU7 external routing is not required).
- If T1 DTCs exist in table LTCINV, LIU7 external routing must be active.

Datafill

The following table lists datafill for table C7LINK.

Field descriptions (Sheet 1 of 8)

Field	Subfield	Entry	Explanation and action
LINKNAME		see subfields	<i>CCS7 link name</i>
	LINKSET	alphanumeric (1 to 16 characters)	<i>Linkset name</i> Enter the name of the linkset of which the link is a member. This linkset name must exist in table C7LKSET.

C7LINK (continued)

Field descriptions (Sheet 2 of 8)

Field	Subfield	Entry	Explanation and action
	LINKSLC	0 to 15	<p><i>Signaling link number</i></p> <p>Enter a signaling link number to identify the link within the linkset. Subfields LINKSET and LINKSLC identify a particular link.</p> <p>The signaling link number must be the same at both ends of the linkset. The value in field LINKSLC in table C7LINK at opposing ends of the linkset must match. If the values in subfield LINKSLC do not match, the link cannot stabilize.</p> <p>Any links added to a linkset that is datafilled in table C7GTWLKS must have allocation scheme LIUBASIC and/or LIUCHANNEL. Gateway screening procedures are only supported on Common Channel Signaling 7 LIU7, HLIU and HSLR links.</p> <p>The only valid link indexes for Japan Public Networks 7 (JPN7) are 0 to 7.</p>
LINKDATA		see subfield	<p><i>Link data</i></p> <p>This field consists of subfield ALLOC.</p>

C7LINK (continued)

Field descriptions (Sheet 3 of 8)

Field	Subfield	Entry	Explanation and action
	ALLOC	LIUBASIC, LIUCHANNEL, STBASIC STPOOL	<p><i>Allocation scheme</i></p> <p>This field contains the allocation scheme for the specified linkset.</p> <p>NTC7 links only support LIUBASIC, LIUPOOL, or LIUCHANNEL allocation schemes.</p> <p>If a link interface unit (LIU) is used to meet the throughput requirements of a signaling transfer point (STP), enter LIUBASIC and datafill subfields LIUTYPE and LIUNO.</p> <p>If STP Signaling, Engineering and Administration System (SEAS) is present in the load, LIUBASIC is the only valid entry.</p> <p>If a HSLR is used to provide link routing functionality, enter LIUBASIC.</p> <p>Note 1: STBASIC and STPOOL are not supported entries on the DMS-INode switch, but they are visible options.</p> <p>Note 2: Any link that belongs to a linkset datafilled in table C7GTWLKS must have an allocation scheme of LIUBASIC, LIUCHANNEL or both. Gateway screening procedures are only supported for LIU7/HSLR links.</p> <p>If the LIU channel provides the definition of the CCS7 signaling channel path, enter LIUCHANNEL and datafill subfields LIUTYPE, LIUNO, and TL.</p>

C7LINK (continued)

Field descriptions (Sheet 4 of 8)

Field	Subfield	Entry	Explanation and action
			<p>If both the signaling terminal (ST) and the transmission link (TL) are explicitly specified, enter STBASIC and datafill subfields STNO and TL.</p> <p>If the TL is specified and the ST is selected from the pool of STs, enter STPOOL and datafill subfields STPOOL and TL.</p> <p>Note: For JPN7 networks, a validation is made to ensure that the value in field TF of table C7TIMER is in accordance with the value in field NUMFLAGS of table C7LKSET. JPN7 links only support LIUCHANNEL and LIUBASIC allocation schemes for signaling terminals. For channelized access, LIUCHANNEL must be used. The following equation is used to verify this restriction:</p> $tf = (\text{numflags} + 3) \vee 3$ <p>where</p> <p>tf is the flag count value from table C7TIMER</p> <p>numflags is the number of flags from table C7LKSET</p> <p>v is the positive integer value (greater than zero) that satisfies the equation</p>
	STNO	0 to 1023	<p><i>Signaling terminal number</i></p> <p>If the entry in field ALLOC is STBASIC, enter the ST number used for the link. This number is defined in table STINV.</p>
	STPOOL	0 to 14 or N	<p><i>Signaling terminal pool number</i></p> <p>If the entry in field ALLOC is STPOOL, enter the ST pool number to specify the pool of STs from which the reserved ST is selected for the link. The ST pool is defined in table STPOOL.</p>

C7LINK (continued)

Field descriptions (Sheet 5 of 8)

Field	Subfield	Entry	Explanation and action
	TL	see subfields	<p><i>Transmission link</i></p> <p>This subfield consists of subfields CLLI and EXTRKNM. If the entry in field ALLOC is STBASIC, STPOOL, or LIUCHANNEL, datafill this subfield to specify the name of the digital trunk used to transmit data for the link. The specified trunk is used as the startup link.</p>
	CLLI	alphanumeric (1 to 16 characters)	<p><i>Common language location identifier</i></p> <p>Enter the CLLI of the digital trunk used to transmit data for the link.</p>
	EXTRKNM	0 to 9 999	<p><i>External trunk number</i></p> <p>Enter the external trunk number for the digital trunk that is specified in field CLLI.</p>
	LIUTYPE	ELIU, HSLR, LIU7	<p><i>Link interface PM type</i></p> <p>Enter ELIU, HSLR, or LIU7 to specify the peripheral module (PM) type for the PM on which the LIU is mounted.</p> <p>Enter ELIU if the ASU type is Ethernet link interface unit.</p> <p>Enter HSLR if the ASU type is dual-link interface unit (DLIU).</p> <p>Enter LIU7 if the ASU type is CCS7 link interface unit.</p>
	LIUNO	0 to 511	<p><i>Link interface unit number</i></p> <p>Enter the number of the LIU. The LIU number must be datafilled in table LIUINV before datafilling this field.</p> <p>Entries outside this range are invalid.</p>
CLASDATA		see subfield	<p><i>Class data</i></p> <p>This field consists of subfield LINKCLAS.</p>
	LINKCLAS	MTP2, SAAL	<p><i>Link class</i></p> <p>This field consists of subfields MTP2 and SAAL.</p>
	MTP2	see subfields	<p><i>Message transfer part layer 2</i></p> <p>This field consists of subfield Q703_INDEX</p>

C7LINK (continued)

Field descriptions (Sheet 6 of 8)

Field	Subfield	Entry	Explanation and action
	Q703_INDEX	0 to 31	Enter the index number of the Q703 tuple in table C7TIMER that is used for this link.
	SAAL	see subfields	<i>Signaling ATM adaptation layer</i> This field consists of subfields SAAL_INDEX, LKPARAM_INDEX, CARRMTC_INDEX, VPI, and VCI.
	SAAL_INDEX	0 to 31	Enter the index number of the SAAL tuple in table C7TIMER that is used for this link.
	LKPARAM_INDEX	0 to 31	Enter the index number of the SAAL tuple in table C7LKPARAM used for this link.
	CARRMTC_INDEX	character string	Enter the template number of the HLIU tuple in table CARRMTC used for this link.
	VPI	0 to 255	<i>Virtual path identifier</i> Enter the value that identifies the virtual path for the connection of a high-speed link to an ATM network. The default value is 0.
	VCI	0 to 65535	<i>Virtual channel identifier</i> Enter the value that identifies the virtual channel for the connection of a high-speed link to an ATM network. The default value is 5.
Q707		0 to 31	<i>Q707</i> Enter the index number of the Q707 tuple in table C7TIMER that is used for this link.
LINKOPT		vector of up to 4 options	<i>Link options</i> If fewer than two multiples are required, end the list with a \$.

C7LINK (continued)

Field descriptions (Sheet 7 of 8)

Field	Subfield	Entry	Explanation and action
	OPTIONS	PCR MSBPCR SLMPR SUERM, or MLIU_CH	<p><i>Options</i></p> <p>If preventative cyclic retransmission (PCR) error correction is applied to the link, enter PCR and datafill subfield TLTIME. PCR can only be entered if CCS7 Preventative Cyclic Retransmission is present. This capability applies only to CCS7 signaling links using a LIU-type peripheral module that is restricted to the DMS-STP switch.</p> <p>If PCR error correction is used on the signaling terminal card of the message switch and buffer 7 (MSB7), enter MSBPCR and datafill subfield TLTIME. MSBPCR can only be entered if Preventative Cyclical Retransmission Error Correction is on MSB7. This capability applies only to the CCS7 signaling terminal card of an MSB7, and is restricted to a DMS-STP switch.</p> <p>Note: MSB7 is not support on the DMS-INode switch.</p> <p>The basic error correction method applies if PCR error correction is not used.</p> <p>If the link is to be included in the signaling link marginal performance report, enter SLMPR. No additional data is required with this entry value. If Signaling Link Marginal Performance Report is present and SLMPR is not entered as an option, the link is not included in the report unless it exceeds one of the thresholds.</p> <p>To specify the signaling unit error rate value for the link, enter SUERM and datafill subfield SUERM. If the signaling unit error count exceeds the specified error rate threshold, the DMS takes down the links.</p> <p>Note: Value MLIU_CH is functional in software release MMP-12. Subfield PORT_NUMBER is associated with value MLIU_CH. Value MLIU_CH is visible but does not affect functionality in software release TL11.</p>

C7LINK (continued)

Field descriptions (Sheet 8 of 8)

Field	Subfield	Entry	Explanation and action
	PORT_ NUMBER	0 to 3	<p><i>Port number</i></p> <p>If the value in subfield OPTIONS is MLIU_CH, enter a value for the port number used by the link on the MLIU.</p>
TLTIME		1 to 500	<p><i>Transmission link time</i></p> <p>This field only appears in table C7LINK if CCS7 Preventative Cyclical Retransmission is present and the entry in field OPTIONS is PCR, or if Preventative Cyclical Retransmission Facilities is on MSB7 and the entry in field OPTIONS is MSBPCR. Field TLTIME contains the time it takes to send a CCS7 message signaling unit (MSU) from one signaling point (SP) to another SP over a satellite transmission link.</p> <p>Enter the time duration (in 100-ms units) between when an MSU leaves an LIU and when it reaches the LIU at the far end through a satellite. The value in field TLTIME is used to calculate the PCR threshold value (the number of unacknowledged bytes the ST transmits before retransmitting).</p>
	SUERM	32 to 255	<p><i>Signaling unit error rate monitor</i></p> <p>If the value in field OPTIONS is SUERM, enter the signaling unit error rate threshold value for this link. The recommended range of values is 64 to 128.</p> <p>An SUERM value lower than 64 is not recommended since this can cause higher sensitivity (lower tolerance) to errors. An SUERM value greater than 128 is not recommended since this can cause congested signaling links. In both cases, a message is generated to warn operating company personnel.</p> <p>Link maintenance actions DEACT (deactivate) and ACT (activate) must be executed in order to make a change effective.</p> <p>If the signaling unit error count exceeds the threshold, the DMS switch takes down the links.</p>

C7LINK (continued)**Datafill example**

The following example shows sample datafill for table C7LINK.

MAP display example for table C7LINK

LINKNAME		LINKDATA			
Q703		Q707		LINKOPT	
C7LKSET1	0	LIUCHANNEL	LIU7 101	CCS7TL200	2
	0		0		
					\$
C7LKSET1	1	STBASIC	103	CCS7TL100	1
	0		0		
					\$
C7LKSET1	2	STBASIC	104	CCS7TL100	2
	0		0		
					\$
C7LKSET2	0	STBASIC	108	CCS7TL120	0
		MTP2	0	0	
					\$
C7LKSET2	1	STBASIC	109	CCS7TL120	1
		MTP2	0	0	
					\$
C7LKSET2	2	STBASIC	110	CCS7TL120	2
		MTP2	0	0	
					\$
C7LKSET3	0	LIUBASIC	HSLR 1	SAAL	0
			0	DEFAULT	0 5 0
					\$
C7C7LKSET3	1LKSET3	1	LIUBASIC	HSLR 2	SAAL
			0	DEFAULT	0 5 0
					\$
SSP1_LK	0	LIUCHANNEL	MLIU 25	CA_TRK	0
		MTP2	0		0
					\$

C7LINK (continued)

Supplementary information

This section provides information on error messages, restrictions, and dump and restore procedures for table C7LINK.

Adding a link

To add a link observe the following rules:

- The linkset specified must be listed in table C7LKSET.
- The link must be in the offline state when the fields are changed.
- If the allocation scheme is STBASIC, the ST number specified must be defined in table STINV and designated for CCS7 use.
- If the allocation scheme is STBASIC or STPOOL, the specified TL must be a defined trunk, not just a valid common language location identifier (CLLI).
- The signaling system 7 (SS7) must have a linkset type (field LSTYPE in table C7LKSET) of ALINK and an allocation scheme (field ALLOC in table C7LINK) of STBASIC or STPOOL. Assign these links to different digital trunk controllers (DTC) in table TRKMEM to provide redundancy. Failure to do this leads to an SS7 outage when the DTC goes out of service.
- If the allocation scheme is STPOOL, the ST pool must be defined for CCS7 use, the ST pool data must be valid, and the ST pool specified must be defined.
- If the allocation scheme is STBASIC, the ST must not already be reserved for use by another link.
- If the allocation scheme is STBASIC or STPOOL, the specified TL must not be allocated for use by another linkset.
- Any links added to a linkset that is datafilled in table C7GTWLKS must have an allocation scheme of LIUBASIC. Gateway screening procedures are supported only on LIU7 or HSLR-based links.
- Do not exceed the maximum of four HSLs per linkset.
- The link must be on the same MSB as the linkset to which this link is added.
- For all allocation schemes, the index specified in fields Q703 and Q707 must exist in table C7TIMER.

C7LINK (continued)

- For SSP or INode offices, LIU7 external routers must reside on any of the following platforms:
 - LPP, enhanced LPP (ELPP), fiberized LPP (FLPP)
 - SNSE LIS
 - FLIS
- For ITU and NTC7 networks, you can datafill more than 8 (up to 16) A, E, and F links, with the following restrictions:
 - The linkset to which you are adding the link is not a part of a combined linkset defined in table C7RTESET.
 - The linkset is not a member of a GTT equal cost result in table C7GTT.

Maintaining redundancy

If members of a linkset are mapped to the same MSB port and the connection is lost, the trunk goes down and causes an outage. It is, therefore, important to maintain redundancy.

To achieve redundancy, linksets must be distributed between ST cards that have different C-side port assignments. Check the C-side ports of the ST card to ensure that this criterion is met.

Modifying a link

To modify a link observe the following rules:

- The fields that can be modified are the fields that are prompted in association with the allocation scheme.
- If the allocation scheme is STBASIC, fields STNO, TL, Q703, and Q707 can be modified.
- If the allocation scheme is STPOOL, fields STPOOL, TL, Q703, and Q707 can be modified.
- If the allocation scheme is LIUBASIC, fields LIUTYPE, LIUNO, Q703, Q707, and LINKOPT can be modified. Options PCR and SLMPR only appear in field LINKOPT if CCS7 Preventative Cyclical Retransmission and Signaling Link Marginal Performance Report are present.
- Any link that belongs to a C7GTWLKS linkset cannot have its allocation scheme changed to anything other than LIUBASIC, LIUCHANNEL or both. Gateway screening procedures are supported only on LIU7-based links.

C7LINK (continued)

- If a link is reassigned to a different linkset, delete it from the existing linkset and add it to the new linkset. The link is keyed on linkset name and link number. Keys cannot be modified.
- For all allocation schemes, the index specified in fields Q703 and Q707 must exist in table C7TIMER.

Deleting a link

The linkset from which the link is deleted must be offline.

Information message

If office parameter USP_ACTIVE_IN_NETWORK is set to Y, you cannot access this table. The following message appears when you try:

```
*****
**                               ACCESS DENIED                               **
*****
**                               **
** The USP is now used to administer the SS7 data. **
** SS7 linksets and links now only exist on the USP. **
** There is no information to display for this table. **
**                               **
** Go to the GUI on the USP to access this data. **
*****
```

Error messages

Error messages may be produced due to the constraints on the number of links in a linkset of a given linkset type. These error messages are described in the following text.

The maximum number of links in a linkset is four in networks AUSTR7 and CCITT7 with an LSTYPE of BLINK or DLINK. The maximum number of links with an LSTYPE of CLINK is eight in both networks. If the link being added exceeds the maximum number of links allowable for the LSTYPE, the tuple is rejected and the following error message is displayed:

No more than 4 HSLs can be datafilled per linkset.

Note: LSTYPE is defined in table C7LKSET.

The maximum number of links in a linkset is eight in network ANSI7 with an LSTYPE of BLINK, CLINK, or DLINK. The maximum number of links in a linkset is also eight in network AUSTR7 with an LSTYPE of ALINK, ELINK, or FLINK. If the link being added exceeds the maximum number of links

C7LINK (continued)

allowable for the LSTYPE, the tuple is rejected and the following error message is displayed:

```
LINKSET WOULD EXCEED THE MAXIMUM OF 8 LINKS FOR THE LSTYPE
SELECTED.
```

The maximum number of links in a linkset is 16 in networks ITU and NTC7 with an LSTYPE of ALINK, ELINK, or FLINK. The system displays error messages when:

- you try to datafill more than eight links, and the indicated linkset is a member of a combined linkset (equal cost route defined in table C7RTESET). The following message appears:

```
LINKSET belongs to combined routing and would exceed link
limit of 8 for this LSTYPE. Check table C7RTESET for equal
cost route.
```

- you try to datafill more than eight links, and the indicated linkset is a member of an equal cost result defined in table C7GTT. The following message appears:

```
LINKSET belongs to equal cost GT result and would exceed link
limit of 8 for this LSTYPE. Check table C7GTT for equal cost
result.
```

If the 8-bit SLS signaling link selector (SLS) functionality is activated, the maximum number of links in a linkset is 16, if the network type is ANSI7 and the LSTYPE is BLINK, CLINK, or DLINK. If the link being added causes the maximum number of allowable links for the LSTYPE to be exceeded, the tuple is rejected and the following error message is displayed:

```
LINKSET WOULD EXCEED THE MAXIMUM OF 16 LINKS FOR THE LSTYPE
SELECTED.
```

World Trade and GSM software loads increase the maximum number of links that can be datafilled in an SSP or INode office from 108 to 180 (refer to feature AU3246 and 59009996). The next error message applies to the World Trade and GSM software load only.

The following error message appears, when you attempt to datafill more than 108 links in table C7LINK when table LTCINV contains T1 DTC datafill and LIU7 external routing is not active:

```
FAILED: Can not add link because DTC datafilled in table LTCINV.
Activate LIU7 external routing and remove MTP databases or
remove DTC datafill to be able to add greater than 108 links.
```

C7LINK (continued)

If the value in table C7TIMER subfield SAALT3 or the value in table C7LKPARM subfield RPDU is too low, the following error message appears:

EXCESSIVE PROVING PDU RATE

The following parameter relationship has been violated for one or more links using this tuple: $\{100\ 000 / c7timer-saal-t3\} * 1.2 \leq c7lkparm-rpdu100\ 000$ is a unit conversion factor 1.2 provides a 20% safety margin

The error message includes an algebraic formula, in which:

- c7timer-saal-t3 indicates the value in table C7TIMER, parameter SAALT3.
- c7lkparm-rpdu indicates the value in table C7LKPARM, parameter RPDU.

To clear the error message increase one or both of the values. The following table indicates suggested values for each field.

Suggested values for parameters SAALT3 in table C7TIMER and RPDU in table C7LKPARM

C7TIMER-SAALT3	C7LKPARM-RPDU
90 - recommended value	1680 - recommended value
90	1335 to 1680
72 to 2300	1680
90 to 2300	1400

If the value in table C7TIMER subfield SAALT2 is too low or if the values in table C7TIMER subfield SAALT3 and table C7LKPARM subfield SSCFN1 are too high, the following error message appears:

EXCESSIVE PROVING TIME

The following parameter relationship has been violated for one or more links using this tuple: $\{c7timer-saal-t3 * c7lkparm-sscfnl * 1.2\} / 10\ 000 \leq c7timer-saal-t210\ 000$ is a unit conversion factor 1.2 provides a 20% safety margin

C7LINK (continued)

The error message includes an algebraic formula, in which:

- `c7timer-saal-t3` indicates the value in table `C7TIMER`, parameter `SAALT3`.
- `c7lkparm-sscf1` indicates the value in table `C7LKPARM`, parameter `SSCFN1`.
- `c7timer-saal-t2` indicates the value in table `C7TIMER`, parameter `SAALT2`.

To clear the error message do one or more of the following:

- increase the value in table `C7TIMER` subfield `SAALT2`
- decrease the value of table `C7TIMER` subfield `SAALT3`
- decrease the value of table `C7LKPARM` subfield `SSCFN1`

The following table indicates suggested values for each field.

Suggested values for parameters `SAAL73` in table `C7TIMER`, `SSCFN1` in table `C7LKPARM`, and `SAALT2` in table `C7TIMER`

C7TIMER-SAALT3	C7LKPARM-SSCFN1	C7TIMER-SAALT2
90 - recommended value	6250 - recommended value	120 - recommended value
90	6250	70 to 180
90	50 to 6250	120
90 to 160	6250	120

The system allows a manual verification of the value in the VCI field.

The system displays the following error messages when there is no entry in the VCI field:

```
Warning: VCI value missing, must be datafilled in the range: 0
- 65535.
```

The system displays the following error message if the value you enter in the VPI field is beyond the range of 0 to 255:

```
*** ERROR ***

TYPE OF VPI IS VPI_RANGE

TYPE IS VPI_RANGE {0 TO 255}
```

C7LINK (end)

VPI:0

The system displays the following message if the value you enter in the VCI field is beyond the range of 0 to 65535:

VCI must be between 0 and 65535.

When table C7TRKMEM contains more than 100000 entries, it requires links in table C7LINK to use 32-Mbyte LIU7s. Any change operation on an existing link in table C7LINK must not change the LIU7 used by the link to a non-32-Mbyte LIU7. The system displays the following error message if the above conditions are violated:

The current number of ISUP Circuits is <number>. This link will not be able to support this. Please remove tuples from table C7TRKMEM before making this change to this table.

C7LKPARAM

Table name

Common Channel Signaling 7 Link Parameter Table

Functional description

Table C7LKPARAM contains the CCS7 link parameter values used in a single data structure and applied to multiple links in a class that have the same characteristics. Table C7LKPARAM only contains datafill for CCS7 links with a signaling ATM adaptation layer (SAAL).

Datafill sequence and implications

There is no requirement to datafill other tables prior to table C7LKPARAM.

Table size

32 tuples

Datafill

The following table lists datafill for table C7LKPARAM.

Field descriptions (Sheet 1 of 3)

Field	Subfield or refinement	Entry	Explanation and action
LKPRMKEY			<i>Link parameter key</i> This field consists of subfields TYPE and ID.
	TYPE	SAAL	<i>Link protocol type</i> Enter the SAAL for the link protocol type.
	ID	0 to 31	<i>Unique link identifier</i> Enter the unique link identifier.
MAXCC		1 to 10	<i>Maximum value for VT(CC)</i> Enter the maximum value for the transmitter state variable (VT) connection control (CC) count in protocol data units (PDU). The default value is 4.
MAXPD		5 to 2120	<i>Maximum value for VT(PD)</i> Enter the maximum value for VT poll data (PD) count in PDUs. The default value is 500.

C7LKPARM (continued)

Field descriptions (Sheet 2 of 3)

Field	Subfield or refinement	Entry	Explanation and action
MAXSTAT		3 to 1021	<p><i>Maximum list elements in STAT PDU</i></p> <p>Enter the maximum list elements in STAT PDU.</p> <p>The default value is 67.</p>
SSCFN1		50 to 6250	<p><i>PDU's sent during normal proving</i></p> <p>Enter the number of PDU's sent during normal proving.</p> <p>Enter the limit in units of 10.</p> <p>The default value is 6250 (62500 PDU's).</p>
MAXNRP		1 to 10	<p><i>Failed proving attempt threshold</i></p> <p>Enter the failed proving attempt threshold in terms of retransmitted messages.</p> <p>The default value is 1.</p>
ISERMALP		0 to 1000	<p><i>Exponential smoothing factor</i></p> <p>Enter the exponential smoothing factor.</p> <p>Enter the limit in units of .001.</p> <p>The default value is 100 (exponential smoothing factor .1).</p>
ISERMTHR		0 to 1000	<p><i>Quality of service threshold</i></p> <p>Enter the quality of service threshold.</p> <p>Enter the limit in units of .001.</p> <p>The default value is 244 (quality of service threshold .244)</p>
ISERMN		1 to 25	<p><i>Number of monitoring intervals</i></p> <p>Enter the number of monitoring intervals.</p> <p>The default value is 9.</p>
ISERMNBK		1 to 10	<p><i>Monitoring intervals per block</i></p> <p>Enter the number of monitoring intervals per block.</p> <p>The default value is 3.</p>

C7LKPARM (continued)

Field descriptions (Sheet 3 of 3)

Field	Subfield or refinement	Entry	Explanation and action
RPDU		1 to 1680	<p><i>Rate in messages per second</i></p> <p>Enter the rate in messages per second for flow controlling received messages.</p> <p>The default value is 1680.</p> <p>Note: For a signaling connection control part (SCCP) linkset, the range is 1 to 1400.</p>
FLOWBC		1 to 5	<p><i>Poll frequency using fixed credit flow control</i></p> <p>Enter the poll frequency used to update credit.</p> <p>The default value is 2.</p> <p>Note: Nortel recommends using the default value. If you use any other value, the optimal operation of the link can be affected.</p>

Datafill example

The following example shows sample datafill for table C7LKPARM.

MAP display example for table C7LKPARM

```

LKPRMKEY MAXCC MAXPD MAXSTAT SSCFN1 MAXNRP ISERMALP
ISERMTHR ISERMN ISERMNBK RPDU FLOWBC
-----
SAAL 0      4    500      67    500      1      100
      244      9      3    1680      2

```

Table history**TL11**

Removed datafill restrictions. Added error messages.

TL10

Updated default value for field RPDU.

C7LKPARAM (continued)**STP04.0**

Updated entries for field RPDU. Added error messages.

TL07

Table C7LKPARAM was introduced.

Supplementary information**Error messages**

If the value in table C7TIMER subfield SAALT3 or the value in table C7LKPARAM subfield RPDU is too low, the following error message appears:

EXCESSIVE PROVING PDU RATE

The following parameter relationship has been violated for one or more links using this tuple: $\{100\ 000 / c7timer-saal-t3\} * 1.2 \leq c7lkparm-rpdu100\ 000$ is a unit conversion factor 1.2 provides a 20% safety margin

The error message includes an algebraic formula, in which:

- c7timer-saal-t3 indicates the value in table C7TIMER, parameter SAALT3.
- c7lkparm-rpdu indicates the value in table C7LKPARAM, parameter RPDU.

To clear the error message increase one or both of the values. The following table indicates suggested values for each field.

Suggested values for parameters SAALT3 in table C7TIMER and RPDU in table C7LKPARAM

C7TIMER-SAALT3	C7LKPARAM-RPDU
90 - recommended value	1680 - recommended value
90	1335 to 1680
72 to 2300	1680
90 to 2300	1400

If the value in table C7TIMER subfield SAALT2 is too low or if the values in table C7TIMER subfield SAALT3 and table C7LKPARAM subfield SSCFN1 are too high, the following error message appears:

EXCESSIVE PROVING TIME

C7LKPARAM (end)

The following parameter relationship has been violated for one or more links using this tuple: $\{c7timer-saal-t3 * c7lkparm-sscfn1 * 1.2\} / 10\ 000 \leq c7timer-saal-t2$ 1000 is a unit conversion factor 1.2 provides a 20% safety margin

The error message includes an algebraic formula, in which:

- c7timer-saal-t3 indicates the value in table C7TIMER, parameter SAALT3.
- c7lkparm-sscfn1 indicates the value in table C7LKPARAM, parameter SSCFN1.
- c7timer-saal-t2 indicates the value in table C7TIMER, parameter SAALT2.

To clear the error message do one or more of the following:

- increase the value in table C7TIMER subfield SAALT2
- decrease the value of table C7TIMER subfield SAALT3
- decrease the value of table C7LKPARAM subfield SSCFN1

The following table indicates suggested values for each field.

Suggested values for parameters SAALT3 in table C7TIMER, SSCFN1 in table C7LKPARAM, and SAALT2 in table C7TIMER

C7TIMER-SAALT3	C7LKPARAM-SSCFN1	C7TIMER-SAALT2
90 - recommended value	6250 - recommended value	120 - recommended value
90	6250	70 to 180
90	50 to 6250	120
90 to 160	6250	120

C7LKSET

Table name

CCS7 Linkset Table

Functional description

Table C7LKSET defines the characteristics of a linkset. A linkset is a set of links grouped to provide one logical path between adjacent nodes. Each link carries traffic between the origination point code and a far-end point code. The table also defines attributes that are common to all links in the linkset. Individual links are defined in table C7LINK.

Note: If office parameter USP_ACTIVE_IN_NETWORK is set to Y, you cannot access information in this table. A message appears referring you to the Graphical User Interface (GUI) on the Universal Signaling Point (USP) for access to data for this table.

Linksets are identified by name and type, and by the point code of the far-end switching unit. Each tuple in table C7RTESET has a destination point code (DPC) which identifies the final destination of the route in the network.

Signaling, Engineering, and Administration System (SEAS) specifies that the linkset's far end must also have an identifier. The identifier is specified in field FECLLI and is for SEAS use only.

Linkset types

The following figure shows linkset types.

C7LKSET (continued)

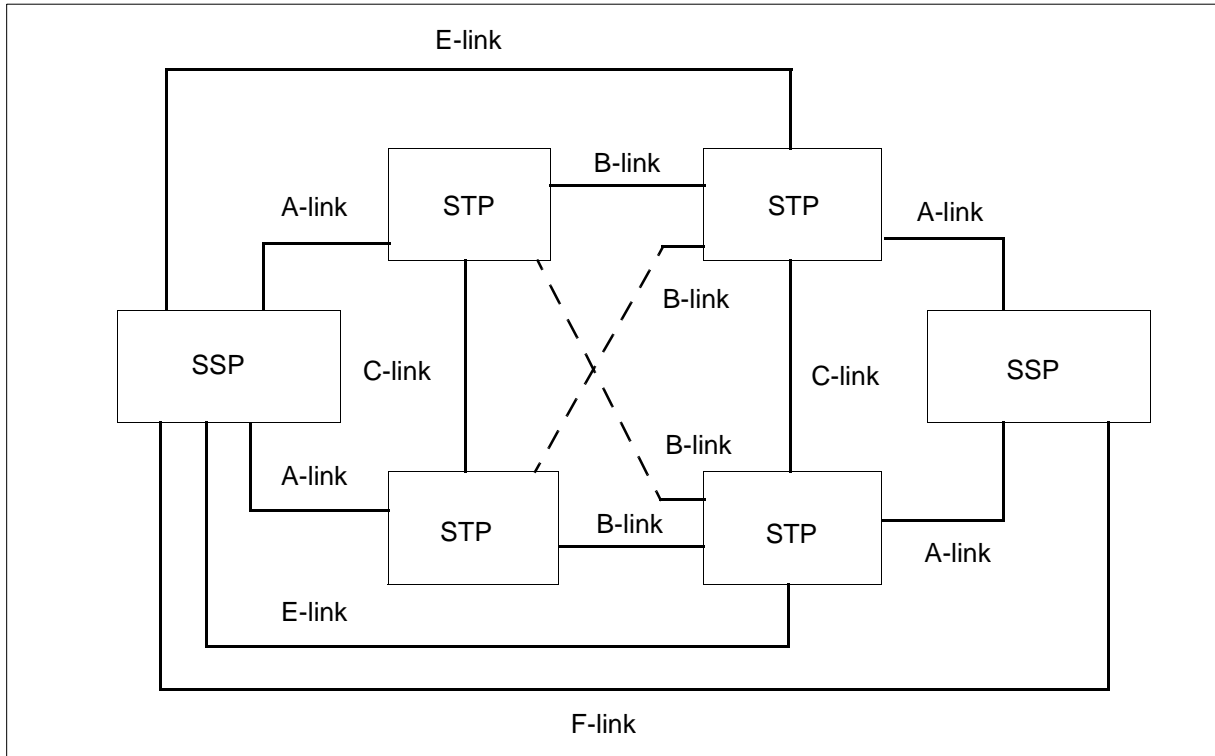
Linkset types

The link connections shown in the above figure are as follows:

- A-links (access links) connect service switching points (SSP) to home signal transfer points (STP).
- B-links (bridge links) connect STP pairs of the same level.
- C-links (cross links) connect STPs to mate STPs.
- D-links (diagonal links) connect primary to regional STPs (not shown).
- E-links (extended links) connect SSPs to remote STPs.
- F-links (fully associated links) connect SSPs.

Adding a linkset

To add a new linkset to table C7LKSET, table C7NETWRK must be datafilled with a valid network name to which the linkset is assigned.

To add a linkset, the following additional information is required:

- linkset name
- linkset type

C7LKSET (continued)

- type of network to which the linkset is added
- far-end point code (FEPC)
- far-end common language location identifier (FECLLI)
- whether the signaling link test is performed at periodic test intervals
- whether the routeset test is run when the linkset first goes into service
- whether the inhibit test is run if any link is inhibited
- index to the tuple in the Q704 timer set in table C7TIMER
- congestion index
- number of flags sent between consecutive signaling units (SU)
- whether message transfer part (MTP) restart is enabled or disabled
- whether the network indicator interworking functionality is enabled or disabled
- whether the automatic inhibiting functionality is enabled or disabled

Modifying a linkset

The linkset must be offline in order to modify most of the fields. Only the MTPRES, NIRPLMT, and AUTOINH fields can be modified when the linkset is in service.

Field NETNAME (network name) cannot be modified.

Deleting a linkset

To delete a linkset, follow the procedure outlined below:

1. Ensure that the linkset is offline.
2. Remove the linkset from all routesets that are defined in table C7RTESET with the linkset as a member.
3. Delete all links in the linkset. See table C7LINK for information about deleting a link.
4. If the linkset is assigned a destination in table C7LSDEST, delete this destination assignment.
5. If the linkset exists in table C7LSUSMT, delete the tuple with that linkset from table C7LSUSMT.
6. Using the linkset name to identify it, delete the linkset.

C7LKSET (continued)**Datafill sequence and meaning**

The following tables must be datafilled before table C7LKSET:

- C7CNGSTN
- C7TIMER
- C7NETWRK

Delete datafill from table C7LSUSMT before deleting a linkset value from table C7LKSET.

Table size

0 to 511 tuples

The size of table C7LKSET is dynamically allocated.

Datafill

The following table lists datafill for table C7LKSET.

Field descriptions

Field	Subfield	Entry	Explanation and action
LINKSET		see subfield	<i>Linkset key</i> This field, which is the key to table C7LKSET, consists of subfield NAME.
	NAME	alphanumeric (1 to 16 characters)	<i>Linkset name</i> Enter the name of the linkset. A CCS7 linkset name can be all numeric characters. For example, a network can have the name of 99 999. This affects MAP-level commands. To post a numerically named linkset at the appropriate MAP level, the name must be enclosed in single quotation marks (` `). For numerically named linksets longer than seven characters, no quotation marks are required. For example, linkset name 12345678 does not require quotation marks to be posted at the MAP level. If STP SEAS is present in the load, the entry in this field must be eight characters.

C7LKSET (continued)**Field descriptions**

Field	Subfield	Entry	Explanation and action
LSTYPE		ALINK, BLINK, CLINK, DLINK, ELINK, or FLINK	<p><i>Linkset type</i></p> <p>This field describes the position of the linkset in the North American CCS7 network architecture.</p> <p>The LSTYPE entry value, which depends on the type of CCS7 node that lies on either end of this linkset, indicates whether the linkset connects two end offices, two STPs, two mated STPs, or an end office and an STP. Figure 1 in the previous “Functional description” section illustrates these linkset types.</p> <p>Enter ALINK (access link) to specify a linkset that connects an SSP to a home STP.</p> <p>Enter BLINK (bridge link) to specify a linkset that connects STP pairs of the same level.</p> <p>Enter CLINK (cross link) to specify a linkset that connects an STP to a mate STP.</p> <p>Enter DLINK (diagonal link) to specify a linkset that connects a primary STP to a regional STP.</p> <p>Enter ELINK (extended link) to specify a linkset that connects an SSP to a remote STP.</p> <p>Enter FLINK (fully associated link) to specify a linkset that connects SSPs.</p> <p>For SSP switching units, use ALINK, ELINK, or FLINK linkset types.</p> <p>For Japan Public Network 7 (JPN7) networks, use ALINK or ELINK linkset types. While ALINK is the typical choice, ELINK can be used to help offset inter-STP traffic. FLINK is for internal testing purposes only and is not supported for operating company usage.</p>

C7LKSET (continued)**Field descriptions**

Field	Subfield	Entry	Explanation and action
NETNAME		alphanumeric (1 to 16 characters)	<i>Network name</i> This field identifies the network to which the linkset belongs. Enter a common language network name as defined in table C7NETWRK.
FEPC		see subfields	<i>Far-end point code</i> This subfield, which specifies the point code at the other end of the linkset, consists of subfield NETTYPE and its refinements. The refinements make up the point code for the specified network type. Note: The far-end point code (FEPC) of the linkset must differ from the point code (PTCODE) of the network to which the linkset belongs. This PTCODE is found by comparing the NETNAME in table C7LKSET with the same NETNAME in table C7NETWRK.
	NETTYPE	ANSI7, CCITT7, NTC7, JPN7, TTC7	<i>Network type</i> If the network type is the North American variant, enter ANSI7 and datafill refinements NETWORK, CLUSTER, and MEMBER. If the network type is the international variant, enter CCITT7 and datafill refinement FORMAT and its associated subfield. If the network type is the NTC7 variant, enter NTC7 and datafill subfield PC. If the network type is Telecommunication Technology Committee Signaling System 7, enter TTC7 and datafill refinements MAINAREA, SUBAREA, and AREAUNIT. If the network type is Japan Public Network 7, enter JPN7 and datafill refinements MAINAREA, SUBAREA, and AREAUNIT.

C7LKSET (continued)**NETTYPE = ANSI7**

If the entry in subfield NETTYPE is ANSI7, datafill the refinements NETWORK, CLUSTER and MEMBER.

Field descriptions for conditional datafill

Field	Subfield	Entry	Explanation and action
	NETWORK	0 to 255	<i>Network identifier</i> Enter the number of the network identifier that is assigned to the far-end switching unit of the specified network.
	CLUSTER	0 to 255	<i>Cluster identifier</i> Enter the number of the network identifier cluster that is assigned to the far-end switching unit of the specified network.
	MEMBER	0 to 255	<i>Member</i> Enter the number of the cluster member that is assigned to the far-end switching unit of the specified network.

C7LKSET (continued)**NETTYPE = CCITT7**

If the entry in subfield NETTYPE is CCITT7, datafill the subfield FORMAT and its refinements.

Field descriptions for conditional datafill

Field	Subfield	Entry	Explanation and action
	FORMAT	AUSTRIA, BASIC, CHINA, GERMAN, INTL, INTL2, or TURK	<p><i>CCITT format</i></p> <p>This field specifies the CCITT7 point code refinements that are required for the network.</p> <p>If the point code used is for Austria, enter AUSTRIA and datafill refinements ZONE, REGION, and SIGPOINT.</p> <p>If the point code used is based on one field, enter BASIC and datafill refinement PC.</p> <p>If the point code used is for China, enter CHINA and datafill refinements ZONE, EXCHANGE, and SIGPOINT.</p> <p>If the point code used is for Germany, enter GERMAN and datafill refinements NUMAREA, HVST, KVST and SIGPOINT.</p> <p>If the point code used is international, enter INTL and datafill refinements ZONE, AREANETW, and SIGPOINT.</p> <p>If the point code used is international-2 with a 4-3-4-3 bit format, enter INTL2 and datafill refinements NETWORK, REGION, GROUP, and MEMBER.</p> <p>If the point code used is for Turkey with a 4-3-7 bit format, enter TURK and datafill refinements ZONE, REGION, and SIGPOINT.</p>

C7LKSET (continued)**Field descriptions for conditional datafill**

Field	Subfield	Entry	Explanation and action
	ZONE	0 to 31	<p><i>Zone identifier</i></p> <p>Enter the zone identifier assigned to the far-end switching unit for the specified network.</p> <p>If the entry in subfield FORMAT is AUSTRIA, the range is 0 to 31.</p> <p>If entry in subfield FORMAT is CHINA, the range is 0 to 15.</p> <p>If the entry in subfield FORMAT is INTL, the range is 0 to 7.</p> <p>If the entry in subfield FORMAT is TURK, the range is 0 to 15.</p>
	AREANETW	0 to 255	<p><i>Area/network identifier</i></p> <p>If the entry in subfield FORMAT is INTL, enter the number of the area/network identifier in the zone that has been assigned to the far-end switching unit for the specified network.</p>
	REGION	0 to 15	<p><i>Region</i></p> <p>If the entry in subfield FORMAT is AUSTRIA, enter the number of the region that has been assigned to the far-end switching unit for the specified network.</p> <p>If the entry in subfield FORMAT is TURK, the range is 0 to 7.</p>
	EXCHANGE	0 to 127	<p><i>Exchange</i></p> <p>If the entry in subfield FORMAT is CHINA, enter the number of the exchange in the zone that has been assigned to the far-end switching unit for the specified network.</p>
	NUMAREA	00 to 15	<p><i>Numbering Area</i></p> <p>If the entry in subfield FORMAT is GERMAN, enter the area number assigned to the office.</p>

C7LKSET (continued)**Field descriptions for conditional datafill**

Field	Subfield	Entry	Explanation and action
	HVST	0 to 7	<p><i>HVSt Area</i></p> <p>If the entry in subfield FORMAT is GERMAN, enter the HVSt number assigned to the office.</p>
	KVST	00 to 15	<p><i>KVSt Area</i></p> <p>If the entry in subfield FORMAT is GERMAN, enter the KVSt number assigned to the office.</p>
	SIGPOINT	0 to 127	<p><i>Signal point identifier</i></p> <p>If the entry in subfield FORMAT is INTL, enter the number of the signal point in the area/network identifier that has been assigned to the far-end switching unit for the specified network. The range is 0 to 7.</p> <p>If the entry in subfield FORMAT is AUSTRIA, enter the number of the signal point in the region that has been assigned to the far-end switching unit for the specified network. The range is 0 to 31.</p> <p>If the entry in subfield FORMAT is CHINA, enter the number of the signal point in the exchange that has been assigned to the far-end switching unit for the specified network. The range is 0 to 7.</p> <p>If the entry in subfield FORMAT is TURK, the range is 0 to 127.</p> <p>If the entry in subfield FORMAT is GERMAN, enter the number of the signal point in the exchange that has been assigned to the far-end switching unit for the specified network. The range is 0 to 7.</p>
	NETWORK	0 to 15	<p><i>Network</i></p> <p>If the entry in subfield FORMAT is INTL2, enter the network assigned to the office.</p>
	REGION	0 to 7	<p><i>Region</i></p> <p>If the entry in subfield FORMAT is INTL2, enter the network assigned to this office.</p>

C7LKSET (continued)**Field descriptions for conditional datafill**

Field	Subfield	Entry	Explanation and action
	GROUP	0 to 15	<i>Group</i> If the entry in subfield FORMAT is INTL2, enter the group assigned to the office.
	MEMBER	0 to 7	<i>Member</i> If the entry in subfield FORMAT is INTL2, enter a numeric value between 0 and 7 for the member assigned to the destination office for the specified network.
	PC	0 to 16383	<i>Point code</i> If the entry in subfield FORMAT is BASIC, enter the number of the FEPC that has been assigned to the far-end switching unit for the specified network.

C7LKSET (continued)**NETTYPE = NTC7**

If the entry in subfield NETTYPE is NTC7, datafill the refinements NMAINAREA, NSUBAREA, and NSIGPOINT.

Field descriptions for conditional datafill

Field	Subfield	Entry	Explanation and action
	NMAINAREA, NSUBAREA, NSIGPOINT	0 to 255	<p><i>Point code</i></p> <p>This subfield is a vector of up to three values that make up the point code (PC) for the destination. This vector must be unique within the specified network.</p> <p>Note: This field is different from the PC field that applies to CCITT7 networks with a CCITT format of BASIC.</p> <p>NMAINAREA corresponds to the main area that is assigned to the office and the specified network.</p> <p>NSUBAREA corresponds to the subarea in the main area that is assigned to the office and the specified network.</p> <p>NSIGPOINT corresponds to the area unit in the subarea that is assigned to the office and the specified network.</p> <p>Enter one, two, or three values to specify the PC vector. If the field contains one or two values, the vector must be terminated by a \$. If the field contains three values (a full PC combination), a \$ is not needed to end the vector. Each entry must be separated from the next by a blank space.</p>

C7LKSET (continued)**NETTYPE = JPN7 or TTC7**

If the entry in subfield NETTYPE is TTC7 or JPN7, datafill the refinements MAINAREA, SUBAREA, and AREAUNIT.

Field descriptions for conditional datafill

Field	Subfield	Entry	Explanation and action
	MAINAREA	0 to 31	<i>Main area</i> Enter the number of the main area that has been assigned to the far-end switching unit for the specified network.
	SUBAREA	0 to 15	<i>Subarea</i> Enter the number of the subarea of the main area that has been assigned to the far-end switching unit for the specified network.
	AREAUNIT	0 to 127	<i>Area unit</i> Enter the number of the area unit in the subarea assigned to the far-end switching unit for the specified network.

For all NETTYPE values

For all subfield NETTYPE values, datafill the fields FECLLI, SIGLKTST, RSTEST, INHTEST, Q704, CNGSTN, NUMFLAGS, and MTPRES.

C7LKSET (continued)

For all subfield NETTYPE values, datafill the fields SIGLKTST, RSTEST, INHTEST, Q704, CNGSTN, CONGENH, NUMFLAGS, MTPRES, and CHNGSLS.

Field descriptions

Field	Subfield	Entry	Explanation and action
FECLLI		alphanumeric (1 to 16 characters)	<p><i>Far-end common language location identifier</i></p> <p>This field is for SEAS use only. If STP SEAS-Operations is present in the load, the entry in field FECLLI must be exactly 11 characters.</p> <p>Enter the common language location identifier (CLLI) of the switching unit at the far end of the linkset.</p>
SIGLKTST		Y or N	<p><i>Signaling link test</i></p> <p>Enter Y if a signaling link test (SLT) is to be sent out periodically on each in-service link in the linkset. It is recommended that this field be set to Y.</p> <p>Enter N if this process is not required.</p> <p>For JPN7 linksets, this field must be set to N.</p> <p>Note: All SIGLKTST tuples in C7LKSET must be set to Y when activating or deactivating the SLT feature with software optionality control (SOC). For more information on SOC, refer to the <i>Software Optionality Control User Guide</i>.</p>
RSTEST		Y or N	<p><i>Routeset test</i></p> <p>This field specifies whether the routeset test runs when a linkset in a routeset becomes available for traffic.</p> <p>Enter Y if a routeset test must be performed on routesets that use this linkset (when the linkset goes into service). Otherwise, enter N.</p> <p>For JPN7 linksets, and for CCITT7 networks used in Australia, this field must be set to N.</p>

C7LKSET (continued)**Field descriptions**

Field	Subfield	Entry	Explanation and action
INHTEST		Y or N	<p><i>Inhibit test</i></p> <p>This field specifies whether the inhibit test runs when any link is inhibited. The inhibit test audits the inhibit indicators at either end of a linkset and corrects any inconsistencies.</p> <p>Enter Y if the inhibit test is required to run when any link is inhibited.</p> <p>This field must be set to N for the following:</p> <ul style="list-style-type: none"> • NTC7 networks • CCITT7 networks used in Australia • JPN7 linksets <p>Otherwise enter N (the default value).</p>
Q704		0 to 31	<p><i>Q704 timer index</i></p> <p>Enter the index of the table C7TIMER tuple that defines the Q704 timers used for this linkset.</p>
CNGSTN		0 to 63	<p><i>Congestion index</i></p> <p>Enter the index of the table C7CNGSTN tuple that defines the congestion thresholds used by this linkset.</p>
NUMFLAGS		1 to 255	<p><i>Number of flags sent between consecutive signaling units</i></p> <p>Enter a numeric value to specify the number of flags that are sent between consecutive signaling units. This value is inversely proportional to the rate at which message signaling signal units are sent over any one link. A lower rate of signal unit transmission results in a decreased load on the far-end signaling terminal since the total amount of traffic that can be carried over the link is reduced.</p>

C7LKSET (continued)**Field descriptions**

Field	Subfield	Entry	Explanation and action
			<p>Far-end signaling terminals (ST) cannot always cope with all offered traffic. The sending of multiple flags is a throttling mechanism that reduces the load on an ST. This is an engineering issue that must be controlled by the far-end ST capability.</p> <p>The default value for this field is 1, which sends a single flag between consecutive signaling units. This value preserves the behavior of existing data. For CCITT7 networks that are used in Australia, this field is usually set to 1 and must never be greater than 32.</p>
MTPRES		Y or N	<p><i>MTP restart</i></p> <p>Enter Y to activate the MTP restart procedure for network type ANS17, CCITT7 or NTC7. Otherwise, enter N.</p> <p>The default value is Y.</p> <p>Enter N for network types TTC7 and JPN7. If operating company personnel attempt to add value Y, the following message appears.</p> <p>MTP Restart is not supported for TTC7 or JPN7 networks. MTPRES must be set to N.</p> <p>Note: If an MTP restart procedure is in progress, the changed value for field MTPRES takes effect after the completion of the in-progress MTP restart procedure. The following message is issued:</p> <p>If an MTP Restart procedure is in progress, the modified control parameter shall be effective at the completion of that procedure.</p>
CHNGSLS		N	<p>This field was created for feature enhancements and is not currently used. The default is N.</p> <p>Note: The STP SEAS ADD_LS command automatically sets CHNGSLS to N.</p>

C7LKSET (continued)**Field descriptions**

Field	Subfield	Entry	Explanation and action
SCCPONLY		Y or N	<p><i>SCCP traffic only traffic type present on the linkset</i></p> <p>If SCCP traffic is the only traffic type present on the linkset, enter Y. If other types of traffic are present, enter N.</p> <p>Note: The STP SEAS ADD_LS command automatically sets CHNGSLS to N.</p>
SUFFLNKS		<p>0 to 16 (for ANSI STP nodes)</p> <p>1 (for non-ANSI STP nodes)</p>	<p><i>Sufficient links</i></p> <p>This field indicates the number of available links considered sufficient to declare the routeset available.</p> <p>For ANSI STP nodes, the default value is the number of links in the linkset divided by 2 (50%). An entry of 0 (zero) represents the default value.</p> <p>If the number entered in this field is greater than the number of links in the linkset, the system uses the default value.</p> <p>For non-ANSI and non-STP nodes, the only valid entry is 1.</p>
NIRPLMT		NIL, INTL, INTLSPARE, NATL, or NATLSPARE	<p><i>Network indicator replacement</i></p> <p>This field indicates whether the network indicator (NI) interworking function is enabled or disabled.</p> <p>Activate the network indicator interworking function by setting SOC option TEL00015 to ON.</p> <p>When the function is activated, the value in the NIRPLMT field indicates the replacement NI that the selected linkset uses.</p> <p>Enter INTL, INTLSPARE, NATL, or NATLSPARE to activate the network indicator replacement function on the selected linkset.</p>

C7LKSET (continued)

Field descriptions

Field	Subfield	Entry	Explanation and action
			<p>The default value is NIL. Enter NIL to disable the network indicator replacement function on the selected linkset.</p> <p>When you activate the function, the system performs the following functions:</p> <ul style="list-style-type: none">• The entry in field NIRPLMT replaces the existing NI of the outgoing messages on the selected linkset.• The MTP discrimination function uses the entry in field NIRPLMT for the incoming messages on the selected linkset.• When the incoming message carries the same NI as the entry in field NIRPLMT, the system converts the incoming message NI to the original NI datafilled in table C7NETWRK.

C7LKSET (continued)**Field descriptions**

Field	Subfield	Entry	Explanation and action
AUTOINH		Y, N	<p><i>Automatic inhibiting</i></p> <p>This field indicates whether the automatic inhibiting function is enabled or disabled.</p> <p>Enter Y to activate the automatic inhibiting function on the selected linkset.</p> <p>Enter N to turn off the automatic inhibiting function on the selected linkset.</p> <p>The default value is Y.</p> <p>After the automatic inhibiting function is activated, the ManB (manual busy) command puts any link, except the last one on the linkset, into local inhibit state.</p>
CONGENH		Y, N	<p><i>Congestion enhancement</i></p> <p>Enter N to disable the false link enhancements detailed below.</p> <p>Enter Y for the false link congestion enhancements to change the existing false link detection algorithm for that linkset. This adds a proving period before the congestion is reported to the reset of the route-set.</p> <p>The proving period is in the range 10 seconds to 2 minutes and is set by T31 timer in table C7TIMER. During the proving period the other links are monitored and if another link goes into congestion, the congestion state is immediately reported to the upper layers. If no congestion is detected on any other links during this timeframe, the LIU7 belonging to that link restarts to clear up any local problems, temporarily taking down the link. Normal operation is resumed when the LIU7 recovers.</p> <p>The default value for the CONGENH field is Y.</p> <p>This field is applicable to ANSI linksets only.</p>

Datafill example

The following example shows sample datafill for table C7LKSET.

C7LKSET (continued)

This example is datafilled in accordance with the following requirements:

- two linksets: C7LKSET4 and C7LKSET5
- linkset type is FLINK
- network name for C7LKSET4 is C7NETWRK4
- network name for C7LKSET5 is C7NETWRK1
- FEPC for C7LKSET4 is ANSI7 4 5 6
- FEPC for C7LKSET5 is ANSI7 74 75 76
- far-end CLLI for C7LKSET4 is C7LKSET4
- far-end CLLI for C7LKSET5 is C7LKSET5
- the signaling link test is disabled
- routeset test is disabled for both linksets
- inhibit test is disabled for both linksets
- index for the Q704 timer in table C7TIMER is 0 (zero)
- congestion index is 0 (zero) for both linksets
- number of flags between consecutive signal units is 1
- MTP restart is enabled for both linksets
- SCCP is not the only traffic on both linksets
- NIRPLMT for C7LKSET4 is NIL
- NIRPLMT for C7LKSET5 is NATL
- Automatic inhibiting function is disabled for C7LKSET4
- Automatic inhibiting function is enabled for C7LKSET5

C7LKSET (continued)

Map display for table C7LKSET

LINKSET	LSTYPE	NETNAME	SIGLKTST	RSTEST	FEPC			
		FECLLI	CNGSTN	NUMFLAGS	INHTEST			
		Q704			MTPRES			
					CHNGSLS			
					SCCPONLY			
					NIRPLMT			
AUTOINH								

C7LKSET4	FLINK	C7NETWRK4			ANSI7	4	5	6
		C7LKSET4	N		Y		N	
		0	0	1		Y		
							N	
								N
								NIL
N								
C7LKSET5	FLINK	C7NETWRK5			ANSI7	74	75	76
		C7LKSET5	N		Y		N	
		0	0	1		Y		
							N	
								N
								NATL
Y								

Table history

CSP18/SN05

Added field CONGENH for feature 19013269 to enhance False Congestion Controls for North American SSP markets using ANSI signaling.

MMP15

Format TURK added for feature 59022376.

MSH14

Message added to direct the user to the GUI on the USP for access to table data when office parameter USP_ACTIVE_IN_NETWORK is set to Y.

STP05

Added fields NIRPLMT and AUTOINH for feature 19007803, Network Indicator Interworking. Expanded table size from 255 to 511 tuples for feature 19007799, Linkset Expansion to 432.

STP04.1

Added format INTL2 and the following refinements: NETWORK, REGION, GROUP, and MEMBER.

C7LKSET (continued)

Added field SUFFLINKS.

STP04.0

Added field SCCPONLY.

TL06

Added error messages.

TL05

Added field MTPRES.

Supplementary information

This section provides information on datafilling table C7LKSET for specific applications, and product descriptive information related to table C7LKSET.

Restrictions if SEAS is present in load

If STP SEAS is present in the load, the following restrictions apply:

- The linkset name (field LINKSET) must be exactly eight characters. If it is not, the tuple is rejected and the following error message is displayed:

Example of a MAP display:

```
SEAS IS PRESENT ON THE STP. LINKSET CLLI MUST BE 8
CHARACTERS. FECLLI MUST BE 11 CHARACTERS.
```

- The name of the office on the far end of the linkset (field FECLLI) must be exactly 11 characters. If it is not, the tuple is rejected and the following error message is displayed:

Example of a MAP display:

```
SEAS IS PRESENT ON THE STP. LINKSET CLLI MUST BE 8
CHARACTERS. FECLLI MUST BE 11 CHARACTERS.
```

Information message

If office parameter USP_ACTIVE_IN_NETWORK is set to Y, the system displays the following message when you try to access this table:

```
*****
**                                ACCESS DENIED                                **
*****
**                                **
** The USP is now used to administer the SS7 data                          **
** SS7 linksets and links only exist on the USP.                            **
** There is no information to display for this table.                        **
**                                **
** Go to the GUI on the USP to access this data.                            **
*****
```

C7LKSET (end)

Error messages

If the node type datafilled in table C7NETWRK is not an STP, then B, C, or D links cannot be added to the linkset tuple. The following error message is displayed:

```
LinkSet cannot be Type B, Type C or Type D.
```

If the node type datafilled in table C7NETWRK is either an STP or an SSP/STP, linkset tuples that contain F links cannot be added. The following error message is displayed:

```
LinkSet cannot be Type F.
```

If you try to delete a linkset, and tuples in table C7LSUSMT are using that linkset value, the following error message displays:

```
Error: The linkset is still in use in table C7LSUSMT
```

C7LOCSSN**Table name**

CCS7 Local Subsystem Table (C7LOCSSN) table

Functional description

Table C7LOCSSN provides information for the local subsystem. The table includes traffic mix information (TFMI) requirements, replication information, an adjacent intermediate node translator list (field AINODES), and a concerned node list (PCNAMES).

For related information, refer to table C7NETSSN.

Datafill sequence and implications

Datafill table C7NETSSN before table C7LOCSSN.

Datafill replicated PCs in table C7NETSSN with a corresponding subsystem entry. Datafill PC names in either the AINODES field or PCNAMES list in C7NETSSN.

Table size

0 to 253 tuples

Memory is dynamically allocated.

Field descriptions

The following table describes field names, subfield names, and valid data ranges for table C7LOCSSN.

(Sheet 1 of 3)

Field	Subfield or refinement	Entry	Explanation and action
SSNAME			SUBSYSTEM NAME. The user of a signaling connection control part (SCCP) is known as a subsystem. The meanings of the predefined subsystem names are described below.
		ACCTSS	Enter ACCTSS to specify the account code validation subsystem.
		AUTHSS	Enter AUTHSS to specify the authcode verification subsystem.

C7LOCSSN (continued)

(Sheet 2 of 3)

Field	Subfield or refinement	Entry	Explanation and action
SSNUMBER		CAIN	Enter CAIN to specify the carrier advanced intelligent network 0.2 messaging subsystem.
		CAINTEST	Enter CAINTEST to specify the CAIN testing subsystem.
		N00	Enter N00 to specify the N00 calling service subsystem.
		TCN	Enter TCN to specify the travel card service subsystem.
		0 to 255	SUBSYSTEM NUMBER. Enter a numeric value for the subsystem number at the specified PC. The subsystem number must be unique within table C7LOCSSN. Note 1: Northern Telecom recommends TCAP subsystem numbering start at 254 and work down. Note 2: It is also recommended that the SSNUMBER match the GTNUM in table C7GTTYE.
MININST		1 to 32	MINIMUM NUMBER OF INSTANCES. Enter one (1) for all UCS DMS-250 SSNs.
REPLINFO		see subfield	REPLICATE INFORMATION. This field consists of subfield REPLFLAG.
	REPLFLAG	Y or N	REPLICATION FLAG. If there is a replicated subsystem for the local subsystem, enter Y (yes) and datafill refinement PCNAME. If there is no replicated subsystem, enter N (no).
	PCNAME	alphanumeric	POINT CODE NAME. If the entry in field REPLFLAG is Y, enter the point code CLLI for the replicated subsystem in the CCS7 network. The subsystem name must be datafilled for this PC in table C7NETSSN.
TFMI		see subfield	TRAFFIC MIX INFORMATION. This field consists of subfield TFMI.

C7LOCSSN (continued)

(Sheet 3 of 3)

Field	Subfield or refinement	Entry	Explanation and action
	TFMI	Y or N	TRAFFIC MIX INFORMATION FLAG. If traffic mix information is required by the local subsystem, enter Y and datafill refinement AINODES. If traffic mix information is not required, enter N.
	AINODES	vector of up to 8 PCs	ADJACENT INTERMEDIATE NODE TRANSLATOR LIST. This refinement, which is only datafilled if the entry in field TFMI is Y, is a vector of eight adjacent PC names. A node is adjacent if it is the last node to do a full translation to the local subsystem. Each entry must be separated from the next by a blank space. Each PC must be datafilled in table C7NETSSN.
PCNAMES		vector of up to 64 PCs	CONCERNED NODE LIST. This field, which is a vector of up to 64 PC names, lists the nodes that are informed of status changes at the local subsystem. By default, all adjacent intermediate node translators are concerned nodes and are not required to appear in this list. All concerned nodes that are not in field AINODES must be included in this vector. The PCs for these nodes must be datafilled in table C7NETSSN.

Datafill example

The following example shows datafill for table C7LOCSSN.

```

SSNAME SSNUMBER MININST REPLINFO TFMI PCNAMES
-----
N00 250 1 N N $
CAIN 253 1 N N (C7RTESET1) $

```

C7LOCSSN (continued)

Supplementary information

This section provides additional information on datafilling table C7LOCSSN.

Adding a tuple to table C7LOCSSN

To add a local subsystem, the following information is required:

- The local subsystem name, which must be valid, must be specified. For valid subsystem names, see the entries for field SSNAME. A subsystem can only be datafilled if its software has been turned on in the switching unit.

Note: ACCTSS and AUTHSS are included in the base UCS DMS-250 switch software, but CAIN, CAINTEST, N00, and TCN require a Software Optionality Control (SOC) to be turned on.

- The subsystem number must be specified. This entry value must be unique within table C7LOCSSN.
- The minimum instance value must be specified. This is the number of instances of the local subsystem that must be in service to provide normal service. Normally only one instance is supported.
- If the local subsystem is replicated, a PC for the location of the replicate must be supplied. Replicate information must be datafilled in table C7NETSSN and cannot exist in table C7RPLSSN for this subsystem. Replicate information can be in either the AINODES field or PCNAMES (a concerned node list).
- Traffic mix information (TFMI) must be specified if it is required by the local subsystem, in which case a list of adjacent intermediate node translators (field AINODES) must be supplied. The PCs in the AINODES field must be datafilled in table C7NETSSN. The list must be unique.
- A concerned node list (PCNAMES) must be specified. This list identifies the nodes (for example, SCPs) that are informed of status changes at the local subsystem. All PCs in this list must be datafilled in table C7NETSSN. The list must be unique and cannot contain any PCs from field AINODES.

Modifying a tuple in table C7LOCSSN

Table C7LOCSSN fields that can be modified are listed below.

- The subsystem number can be modified when the subsystem is offline (OFFL). The subsystem numbers for TUP, ISDNUP, and OAM cannot be changed.
- The minimum instance value can be modified.

C7LOCSSN (end)

- The replication information can be modified. Whether or not the subsystem is replicated, the PC can be changed if it is replicated.
- The traffic mix information (TFMI) flag can be modified.
- The adjacent intermediate node translator (field AINODES) list can be increased by adding new PC names to the list. List items can be deleted by repeating unchanged entries and leaving out the undesired entries.
- PCNAMES (a concerned node list) can be changed in the same manner that the AINODES field is modified.

Deleting a tuple from table C7LOCSSN

To delete a tuple, the following conditions must be met:

- The subsystem must be offline (OFFL).
- No global title translations in table C7GTT can result in this subsystem.

C7NETSSN

Table name

CCS7 Network Subsystem Routing table

Functional description

Table C7NETSSN provides the set of remote point codes (PC) and subsystems at the remote PCs, where messages are routed by the signaling connection control part (SCCP). A PC is a node in the CCS7 network that may be a service switching point (SSP), a signaling transfer point (STP), or a service control point (SCP or database). SCCP routes messages to subsystems at the PC, including SCCP management (SCMG) or SCCP itself, for further global title (GT) translation.

If an STP routeset is unavailable with the MNA7 INode, node isolation on the STP side of the switch is prevented by allowing GTT alternate routing through an available SSP routeset. Table C7NETSSN must be datafilled with identical STP and SSP routesets for this to occur, even when the alternate routeset is not datafilled as a GTT result.

Adding a point code or subsystems to table C7NETSSN

To add a PC to table C7NETSSN (with or without subsystems), the following information is required:

- the PC name CLLI. Routing information for the PC must be datafilled in table C7RTESET.
- extended unit data indicator (XUDTIND). The XUDTIND capability indicator is required on remote nodes that perform global title translation (GTT). The indicator allows STPs to verify if the remote node can process an extended unit data (XUDT) / extended unit data service (XUDTS) message.
- the congestion timer CGT1, activated when the congestion increases
- the congestion timer CGT2, activated when the congestion decreases
- a list of subsystems present at the PC. This list can be nil (\$) since no subsystem name is required for an STP PCNAME. Otherwise, each symbolic ID can be either a member of predefined range of subsystems or a user defined subsystem name and a number. Each list item consists of a subsystem name (SSNAME) and its associated subsystem number (SSNUMBER). The list of subsystem names and numbers must be unique at this PC. If telephone user part (TUP) is specified, the subsystem number must be 2. If integrated services digital network user part (ISDNUP) is specified, the subsystem number must be 3. If operations, administration, and maintenance (OAM) is specified, the subsystem number must be 4.

C7NETSSN (continued)

Modifying a point code or subsystem in table C7NETSSN

The list of subsystems may be altered. Enter a new list of subsystems, repeating those that have not changed, and add any new subsystems. The subsystem names and numbers must be unique at the PC. You can also modify field XU DTIND. Enter Y or N as required, depending on the network configuration.

Any subsystems deleted from the list must not be replicated and must be offline (OFFL). If a subsystem is a member of a replicate pair in table C7RPLSSN, the operating company personnel are notified that table C7RPLSSN must be altered. The tuple containing the subsystem as a member of a replicate pair must be deleted or modified. Unchanged subsystems in the list are not affected.

The subsystem numbers for TUP, ISDNUP, and OAM cannot be changed.

Note: When adding custom local area signaling services (CLASS) functionality, the CCS7 links must first be busied at a MAP (maintenance and administration position) terminal. After completing the datafill, return the CCS7 links to service so that the CLASS feature can function.

Deleting a point code or subsystem from table C7NETSSN

Deletion is allowed if the following conditions are satisfied:

- The PC and all of its subsystems are OFFL at a MAP terminal.
- There are no global title translations (GTT) in table C7GTT that result in this PC or any of its subsystems.

If global title translations exist, the office personnel are informed, and are required to change the results of the translations before attempting to remove the PC or subsystems.

- None of the subsystems being deleted can be replicated.

If a subsystem is a member of a replicate pair in table C7RPLSSN, a warning is issued that table C7RPLSSN must be altered. The tuple

C7NETSSN (continued)

containing the subsystem as a member of a replicate pair must be deleted or modified.



CAUTION

Loss of service

Deletions from table C7NETSSN can affect table MSGRTE. The PC name (field PCNAME in table C7NETSSN) must not be referenced in table MSGRTE before deleting the tuple from table C7NETSSN. Failure to delete the PC name from table MSGRTE before table C7NETSSN results in message routing failure and can affect call processing.

If deleting tuples from table C7NETSSN, ensure that the PC name (field PCNAME in table C7NETSSN) is not referenced by table MSGRTE. If the PC name is referenced in table MSGRTE by an SS7 message route selector, the reference must be removed from table MSGRTE prior to deleting the C7NETSSN tuple.

Failure to delete the PC name reference from table MSGRTE, either by changing to a different PC name or by deleting the tuple entirely, results in invalid tuples being left in table MSGRTE after the referenced tuple is deleting in table C7NETSSN. An attempt to use an invalid tuple message routing results in message routing failure and can impact call processing.

If the PC name is referenced in table C7LOCSSN or C7RSSCRN, the reference must be removed before the tuple can be deleted.

Datafill sequence and implications

Table C7RTESET must be datafilled before table C7NETSSN.

Table size

Up to 2047 tuples

C7NETSSN (continued)**Datafill**

The following table lists datafill for table C7NETSSN.

Field descriptions (Sheet 1 of 6)

Field	Subfield or refinement	Entry	Explanation and action
PCNAME		alphanumeric (1 to 16 characters)	<i>Point code name</i> Enter a PC common language identifier (CLLI) defined by the operating company to identify a PC in the CCS7 network. Routing information for this PC must be datafilled in table C7RTESET. This CLLI corresponds to the remote PC where the subsystems are located.
XUDTIND		Y or N	<i>Extended unit data indicator</i> Enter Y (yes) to indicate that the remote node can support XUDT/XUDTS message types. Enter N (no) to indicate that the remote node cannot support XUDT/XUDTS message types. The default value is Y.

C7NETSSN (continued)

Field descriptions (Sheet 2 of 6)

Field	Subfield or refinement	Entry	Explanation and action
CGT1		0 to 31	<p><i>Congestion timer CGT1</i></p> <p>Enter an integer that starts the timer when the congestion is rising. Each integer represents 1 s.</p> <p>Timer CGT1 and an internal timer of 5 s specify the time during which the system discards all messages with the priority level lower than the internal congestion level. When the congestion level is higher than 1, and no transfer control (TFC) or message transfer part (MTP) messages arrive during the CGT1 plus 5 s period, the level of congestion decreases and timer CGT2 starts.</p> <p>The default value is 0, which deactivates this field. The recommended value is 2.</p> <p>Note 1: The entries in fields CGT1 and CGT2 must both be either 0 or both other than 0.</p> <p>Note 2: This field applies to ITU networks only. For all other networks, the only valid entry is 0, which deactivates the ITU SCCP Congestion Control feature.</p>

C7NETSSN (continued)

Field descriptions (Sheet 3 of 6)

Field	Subfield or refinement	Entry	Explanation and action
CGT2		0 to 31	<p><i>Congestion timer CGT2</i> Enter an integer that starts the congestion timer when the congestion is decreasing. Each integer represents 1 s.</p> <p>When this timer expires, the internal timer of 5 s starts and the congestion level increases or decreases, depending on the reception or lack of reception of TFC or MTP messages. When the congestion level changes to 0, normal operation of a node starts.</p> <p>The default value is 0, which deactivates this field. The recommended value is 1.</p> <p>Note 1: The entries in fields CGT1 and CGT2 must both be either 0 or both other than 0.</p> <p>Note 2: This field applies to ITU networks only. For all other networks, the only valid entry is 0, which deactivates the ITU SCCP Congestion Control feature.</p>
SSNAMES		see subfields	<p><i>Subsystem names and numbers</i> This field is a vector of up to 27 multiples of subfields SSNAME and SSNUMBER. Separate each entry in the vector by a blank space and enter \$ (dollar sign) to indicate the end of the vector. Where the vector is nil, leave the subfields blank and enter \$.</p> <p>Note: For STP and SSP routesets datafilled with the same destination, GTT alternate routing requires that this field be identical for both tuples.</p>

C7NETSSN (continued)

Field descriptions (Sheet 4 of 6)

Field	Subfield or refinement	Entry	Explanation and action
	SSNAME	ACCS, ACCTSS, AIN01, AIN02, AUTHSS, BNS, CMS (see note), E800, ISDNUP, MAPHLR, NSSTCN, N00, OAM, OLNS, REPLDIGS, RTRS, SCPACCS, SCPBNS, SCPE800, TCN, TOPSLNP, TUP800P, or blank	<p><i>Subsystem name</i></p> <p>Enter one of the predefined or user-defined subsystem names, as described below. The subsystem names can be from one to eight characters in length.</p> <p>Enter ACCS for automated calling card service.</p> <p>Enter ACCTSS for account code validation.</p> <p>Enter AIN01 for advanced intelligent network (AIN) messaging subsystem.</p> <p>Enter AIN02 for advanced intelligent network (AIN) messaging subsystem.</p> <p>Enter AUTHSS for authcode verification.</p> <p>Enter BNS for billed number service.</p> <p>Enter CMS for call management service.</p> <p>Note: Canada only</p> <p>Enter E800 for Enhanced 800 Service.</p> <p>Enter ISDNUP for ISDN user part.</p> <p>Enter MAPHLR for destination HLR.</p> <p>Enter NSSTCN for network service software travel card number.</p>

C7NETSSN (continued)

Field descriptions (Sheet 5 of 6)

Field	Subfield or refinement	Entry	Explanation and action
			<p>Enter N00 for N00 calling service.</p> <p>Enter OAM for operations, administration, and maintenance.</p> <p>Enter OLNS for Originating Line Number Screening</p> <p>Enter REPLDIGS for NSS DBCP replace dialed digits.</p> <p>Enter RTRS for TOPS Real-Time Rating System.</p> <p>Enter SCPACCS for ACCS database (SCP).</p> <p>Enter SCPBNS for BNS database (SCP).</p> <p>Enter SCPE800 for E800 database (SCP).</p> <p>Enter TCN for travel card service.</p> <p>Enter TOPSLNP for TOPS Local Number Portability</p> <p>Enter TUP for telephone user part.</p> <p>Enter 800P for the Canadian version of CCS7 800 Service (800 Plus). 800P is provided if package X555 is in the switch. Otherwise, E800 is provided.</p> <p>Note: For DMS-300 switches, leave field SSNAME blank.</p>

C7NETSSN (continued)

Field descriptions (Sheet 6 of 6)

Field	Subfield or refinement	Entry	Explanation and action
	SSNUMBER	2 to 254	<p><i>Subsystem number</i></p> <p>Enter the subsystem number at this PC. The subsystem number must be unique within table C7LOCSSN.</p> <p>If TUP is specified, the subsystem number must be 2.</p> <p>If ISDNUP is specified, the subsystem number must be 3.</p> <p>If OAM is specified, the subsystem number must be 4.</p> <p>Entries outside this range are invalid.</p> <p>Note: For DMS-300 switches, leave field SSNUMBER blank.</p>

Datavill example

The following example shows sample datavill for table C7NETSSN.

MAP display example for table C7NETSSN

PCNAME	XUdTIND	CGT1	CGT2	SSNAMES
SSP1	Y	0	0	(ANI01 120) \$
ANSIRTSABC	N	0	0	(NETRAG 8) \$
ANSIRTSCBA	Y	0	0	(NETRAG 8) \$
CONG_RS3	Y	2	1	(SUB1 56) \$

Table history

CSP14

Feature 59019374 adds fields CGT1 and CGT2.

CSP12

Feature 59009743 expands table C7NETSSN from 256 tuples to 2047 tuples.

CSP10

Field XUdTIND added to C7NETSSN by feature AU3082.

C7NETSSN (end)

NA007

Value AIN02 added to field SSNAME by feature AJ4099.

Value TOPSLNP added to field SSNAME by feature AF6549 in functionality TOPS LNP, OSEA0008.

CSP06

Value OLNS added to field SSNAME by feature AN1564 in functionality TOPS OLNS Interface, ABS00012. Added GTT alternate routing information to functional description and note to SSNAMES field (feature AG5085).

CSP04

Added value RTRS to field SSNAME according to feature AN1504 in functionality External RTRS Interface, ENSV0009

UK002

Entry MAPHLR was added to field SSNAME.

CSP02

A caution note was added regarding the danger of deleting tuples in table C7NETSSN without first deleting the referenced point code name in table MSGRTE.

BCS36

Entry AIN01 was added to field SSNAME.

C7NETWRK

Table name

CCS7 Network Table

Functional description

Table C7NETWRK describes the signaling networks in use in a switching office. Data in table C7NETWRK defines the identity of all routesets in the switching office, with reference to network information. Common Channel Signaling 7 (CCS7) software uses this information to respond to changes in specifications between different network types. Many other CCS7 tables depend on the data in this table.

Note: When office parameter USP_ACTIVE_IN_NETWORK is set to Y, the system displays table information, but does not allow the use of the DMS table editor to add, delete, or change a tuple in this table. If attempts are made to access this table, a message is generated referring the user to the Graphical User Interface (GUI) on the Universal Signaling Point (USP) for proper access to data for table C7NETWRK.

Field NETNAME (network name) is the key to table C7NETWRK. For each network and network type, the originating point code (OPC) of the office and the network indicator (NI) are specified. Each NI can have multiple signaling transfer point (STP) nodes datafilled. The STP point codes that have the same NI can have different network types.

Table C7NETWRK describes network options. The options specify the number of congestion levels used. The options also specify if signaling link selection (SLS) rotation is a part of the routing function, and if the transfer-restricted protocol is a part of the messaging protocol in the network.

Multiple CCS7 network address (MNA7) capability supports message transfer part (MTP) and signaling connection control part (SCCP) specifically for the DMS-STP/SSP Integrated Node (DMS-INode).

Datafill sequence and meaning

Table C7TIMER must be datafilled before table C7NETWRK.

There is no requirement to datafill network names in table CLLI before using them in table C7NETWRK.

Table size

0 to 16 tuples

C7NETWRK (continued)**Datafill**

The following table lists datafill for table C7NETWRK.

Field descriptions

Field	Subfield	Entry	Explanation and action
NETNAME		alphanumeric (1 to 16 characters)	<p><i>Network name</i></p> <p>This field, which is the key to table C7NETWRK, contains the name of the defined network. Enter a network name that is unique to the switching office. This name can be up to 16 characters. An 11-character restriction applies under the following conditions outlined below:</p> <p>If STP-SEAS (Signaling, Engineering and Administration System) is present in the load, the entry in this field must be exactly 11 characters.</p> <p>If the network being datafilled has a field NI value of NATL and a field NETTYPE value of ANSI7, then the entry in field NETNAME must consist of the last 11 characters of office parameter SEAS_UAL_STP_NODE_NAME in table OFCENG.</p>
NODE TYPE		SSP, STP, SCP, SCP_STP, SCP_SSP_STP, SCP_SSP, or SSP_STP	<p><i>Node_type</i></p> <p>This field indicates the node functionality for the tuple entry.</p>
PTCODE		see subfield	<p><i>Office point code</i></p> <p>This field, which defines the address of the office in the network, consists of subfield NETTYPE and its refinements. Subfield NETTYPE specifies the type of network. The NETTYPE refinements specify a unique originating point code (OPC) in the network.</p>

C7NETWRK (continued)**Field descriptions**

Field	Subfield	Entry	Explanation and action
	NETTYPE	ANSI7, CCITT7, JPN7, NTC7, TTC7	<p><i>Network type</i></p> <p>The value of the network type subfield determines which refinements specify the OPC for the network.</p> <p>If the network type is the North American variant, enter ANSI7 and datafill refinements NETWORK, CLUSTER, and MEMBER.</p> <p>If the network type is the international variant, enter CCITT7 and datafill refinement FORMAT.</p> <p>If the network type is the Japanese Public Network 7 variant, enter JPN7 and datafill refinements MAINAREA, SUBAREA, and AREAUNIT.</p> <p>If the network type is the NTC7 variant, enter NTC7 and datafill subfields NMAINAREA, NSUBAREA, and NSIGPOINT.</p> <p>If the network type is the Telecommunication Technology Committee System 7, enter TTC7 and datafill refinements MAINAREA, SUBAREA, and AREAUNIT.</p> <p>STP point codes with the same NI can have different network types.</p>

NETTYPE = ANSI7

If the entry in subfield NETTYPE is ANSI7, datafill refinements NETWORK, CLUSTER, and MEMBER.

Field descriptions for conditional datafill

Field	Subfield	Entry	Explanation and action
	NETWORK	0 to 255	<p><i>Network identifier</i></p> <p>Enter the network identifier assigned to the office for the specified network.</p>

C7NETWRK (continued)

Field descriptions for conditional datafill

Field	Subfield	Entry	Explanation and action
	CLUSTER	0 to 255	<i>Cluster</i> Enter the number of the cluster in the network assigned to the office for the specified network.
	MEMBER	0 to 255	<i>Member</i> Enter the number of the member in the cluster assigned to the office for the specified network.

C7NETWRK (continued)**NETTYPE = CCITT7**

If the entry in subfield NETTYPE is CCITT7, datafill subfield FORMAT and its refinements.

Field descriptions for conditional datafill

Field	Subfield	Entry	Explanation and action
	FORMAT	AUSTRIA, BASIC, CHINA, GERMAN, INTL, INTL2, or TURK	<p><i>CCITT format</i></p> <p>This field specifies the CCITT7 point code refinements for the network.</p> <p>If the point code used is for Austria, enter AUSTRIA and datafill subfields ZONE, REGION, and SIGPOINT.</p> <p>If the point code used is based on one field, enter BASIC and datafill subfield PC.</p> <p>If the point code used is for China, enter CHINA and datafill subfields ZONE, EXCHANGE, and SIGPOINT.</p> <p>If the point code used is for Germany, enter GERMAN and datafill subfields NUMAREA, HVST, KVST, and SIGPOINT.</p> <p>If the point code used is international, enter INTL and datafill subfields ZONE, AREANETW, and SIGPOINT.</p> <p>If the point code used is international-2 with a 4-3-4-3 bit format, enter INTL2 and datafill refinements NETWORK, REGION, GROUP, and MEMBER.</p> <p>If the point code used is for Turkey, enter TURK and datafill subfields ZONE, REGION, and SIGPOINT.</p>
	ZONE	0 to 31	<p><i>Zone identifier</i></p> <p>This field specifies the assigned zone identifier to the destination office and the specified network.</p> <p>If the entry subfield FORMAT is AUSTRIA, enter a number in the range 0 to 31.</p> <p>If the entry in subfield FORMAT is CHINA, enter a number in the range 0 to 15.</p> <p>If the entry in subfield FORMAT is INTL, enter a number in the range 0 to 7.</p>

C7NETWRK (continued)**Field descriptions for conditional datafill**

Field	Subfield	Entry	Explanation and action
			If the entry in subfield FORMAT is TURK, enter a value in the range 0 to 15.
	AREANETW	0 to 255	<i>Areanetwork identifier</i> If the entry in subfield FORMAT is INTL, enter the assigned number of the area/network identifier in the zone to the destination office for the specified network.
	REGION	0 to 15	<i>Region identifier</i> If the entry in subfield FORMAT is AUSTRIA, enter the number of the region identifier in the zone assigned to the destination office for the specified network.
			If the entry in subfield FORMAT is TURK, enter a value in the range 0 to 7.
	EXCHANGE	0 to 127	<i>Exchange</i> If the entry in subfield FORMAT is CHINA, enter the number of the exchange in the zone assigned to the destination office for the specified network.
	NUMAREA	0 to 15	<i>Numbering Area</i> If the entry in subfield FORMAT is GERMAN, enter the area number assigned to the office.
	HVST	0 to 7	<i>Hauptvermittlungsstelle (Tandem Level Switching Exchange)</i> If the entry in subfield FORMAT is GERMAN, enter the HVSt area assigned to the office.
	KVST	0 to 15	<i>Knotenvermittlungsstelle (Trunk Tandem Switching Exchange, regional exchange, 3rd level of transit/long distance network)</i> If the entry in subfield FORMAT is GERMAN, enter the KVSt area assigned to the office.

C7NETWRK (continued)**Field descriptions for conditional datafill**

Field	Subfield	Entry	Explanation and action
	SIGPOINT	0 to 127	<p><i>Signaling point identifier</i></p> <p>If the entry in subfield FORMAT is INTL, enter a numeric value between 0 and 7 for the signal point in the area/network assigned to the destination office for the specified network.</p> <p>If the entry in subfield FORMAT is AUSTRIA, enter a numeric value between 0 and 31 for the signal point in the region assigned to the destination office for the specified network.</p> <p>If the entry in subfield FORMAT is CHINA, enter a numeric value between 0 and 7 for the signal point in the exchange assigned to the destination office for the specified network.</p> <p>If the entry in subfield FORMAT is GERMAN, enter a numeric value between 0 and 7 specifying the signal point code of the exchange.</p> <p>If the entry in subfield FORMAT is TURK, enter a value in the range 0 to 127.</p>
	NETWORK	0 to 15	<p><i>Network</i></p> <p>If the entry in subfield FORMAT is INTL2, enter the network assigned to the office.</p>
	REGION	0 to 7	<p><i>Region</i></p> <p>If the entry in subfield FORMAT is INTL2, enter the region area assigned to the office.</p>
	GROUP	0 to 15	<p><i>Group</i></p> <p>If the entry in subfield FORMAT is INTL2, enter the group assigned to the office.</p>
	MEMBER	0 to 7	<p><i>Member</i></p> <p>If the entry in subfield FORMAT is INTL2, enter a numeric value between 0 and 7 for the member assigned to the destination office for the specified network.</p>

C7NETWRK (continued)**NETTYPE = NTC7**

If the entry in subfield NETTYPE is NTC7, datafill refinements NMAINAREA, NSUBAREA, and NSIGPOINT.

Field descriptions for conditional datafill

Field	Subfield	Entry	Explanation and action
	NMAINAREA	0 to 255	<i>NTC7 main area</i> Enter the number of the main area assigned to the far-end switching unit for the specified network.
	NSUBAREA	0 to 255	<i>NTC7 subarea</i> Enter the number of the subarea of the main area assigned to the far-end switching unit for the specified network.
	NSIGPOINT	0 to 255	<i>NTC7 signaling point</i> Enter the number of the signaling point in the subarea assigned to the far-end switching unit for the specified network.

NETTYPE = JPN7 or TTC7

If the entry in subfield NETTYPE is has value JPN7 or TTC7, datafill refinements MAINAREA, SUBAREA, and AREAUNIT.

Field descriptions for conditional datafill

Field	Subfield	Entry	Explanation and action
	MAINAREA	0 to 31	<i>Main area</i> Enter the number of the main area assigned to the far-end switching unit for the specified network.
	SUBAREA	0 to 15	<i>Subarea</i> Enter a numeric value for the subarea in the main area assigned to this office for the specified network.
	AREAUNIT	0 to 127	<i>Area unit</i> Enter a numeric value for the area unit in the subarea assigned to this office for the specified network.

C7NETWRK (continued)**For all NETTYPE values**

For all subfield NETTYPE entry values, datafill the following additional fields.

Field descriptions for conditional datafill

Field	Subfield	Entry	Explanation and action
NI		INTL, INTLSPARE, NATL, or NATLSPARE	<p><i>Network indicator</i></p> <p>Enter the type of network in this field. For an international network, enter INTL. For an international spare network, enter INTLSPARE. For a national network, enter NATL. For a national spare network, enter NATLSPARE.</p> <p>Both a network indicator (NI) and a network type (NETTYPE) are required to uniquely identify a network.</p> <p>Each NI can support up to 16 STP point codes.</p> <p>Note: STP nodes sharing the same NI and network type must have unique point codes.</p> <p>STP point codes with the same NI can have different network types.</p>
SLSENH		Y or N	<p><i>SLS enhancement</i></p> <p>Enter N to use the original sls to link mapping algorithm.</p> <p>Enter Y to implement a new sls to link algorithm.</p> <p>The new SLS to link mapping is deterministic and provides correct balancing when vendors that use other methods send a non-full distribution of sls values.</p> <p>The default value for SLSENH is N. If patch SSG20/PFY20 is active before the ONP, it is recommended that this value be set to Y after the ONP has been completed. This field is only applicable to CCITT networks.</p>

C7NETWRK (continued)**Field descriptions for conditional datafill**

Field	Subfield	Entry	Explanation and action
SLSROT		Y or N	<p><i>SLS rotation</i></p> <p>This field determines if signaling link selection (SLS) rotation, for load sharing across links and combined linksets, is used as a part of the routing function. If the rotation of links in a linkset is required for loadsharing purposes, enter Y (yes). Otherwise, enter N (no).</p> <p>Note: This field must be assigned Y in an ANSI network. If the field is assigned N in an ANSI network, the following error message displays:</p> <p>SLS ROTation has to be Y in ANSI network.</p> <p>Set this field to N for the following:</p> <ul style="list-style-type: none"> • JPN7 networks • CCITT7 networks used in Australia • NTC7 networks • international networks
TFR		Y or N	<p><i>Transfer restricted</i></p> <p>This field determines if transfer restricted is a part of the messaging protocol in the network. Enter Y if transfer restricted is a part of the messaging protocol in the network. Otherwise, enter N.</p> <p>Set this field to N for the following:</p> <ul style="list-style-type: none"> • CCITT7 networks used in Australia • JPN7 networks

C7NETWRK (continued)**Field descriptions for conditional datafill**

Field	Subfield	Entry	Explanation and action
MCS		1 or 3	<p><i>Multiple congestion</i></p> <p>This field determines the number of congestion levels used. Enter 1 if one level of congestion is required. Enter 3 if three levels of congestion are required.</p> <p>Set North American networks to 1 or 3.</p> <p>Set this field to 1 for the following:</p> <ul style="list-style-type: none"> • CCITT7 networks used in Australia • NTC7 networks • international networks <p>Set this field to 3 for JPN7 networks.</p>
CLUSTERS		Y or N	<p><i>Cluster messages</i></p> <p>This field determines if clustering is a part of the messaging protocol in the network. Enter Y if cluster messages (see note below) can be received. Otherwise, enter N.</p> <p>Set this field to Y for JPN7 networks.</p> <p>Set this field to N for the following:</p> <ul style="list-style-type: none"> • CCITT7 networks used in Australia • NTC7 networks <p>Note: Cluster messages types include: TCR - transfer cluster restricted TCP - transfer cluster prohibited TCA - transfer cluster allowed</p>
RCTEST		Y or N	<p><i>Routeset congestion test</i></p> <p>This field determines if the routeset congestion test is used to relieve remote route congestion. Enter Y if a routeset congestion test is used. Otherwise enter N.</p> <p>Set this field to N for the following:</p> <ul style="list-style-type: none"> • CCITT7 networks used in Australia • JPN7 networks

C7NETWRK (continued)**Field descriptions for conditional datafill**

Field	Subfield	Entry	Explanation and action
MTPRES		Y or N	<p><i>Message transfer part restart</i> Enter Y to enable the MTP restart procedure. Otherwise, enter N.</p> <p>The default value is Y.</p> <p>The MTP restart procedure can be enabled if the network type is ANSI7, CCITT7 or NTC7. The MTP restart procedure is disabled if the network type is TTC7 or JPN7.</p> <p>Note: If an MTP restart procedure is in progress, the changed value for field MTPRES takes effect after the completion of the in-progress MTP restart procedure. The following message is issued.</p> <p>If an MTP Restart procedure is in progress, the modified control parameter shall be effective at the completion of that procedure.</p> <p>Note: The value of field MTPRES is the same for all tuples of network types ANSI7, CCITT7 and NTC7. If an attempt is made to add a tuple with a different value of MTPRES to network types ANSI7, CCITT7 or NTC7 the following message appears:</p> <p>WARNING</p> <p>The MTPRES value must be the same for all networks that support MTP restart. The MTPRES has been updated same as other networks.</p>

C7NETWRK (continued)**Field descriptions for conditional datafill**

Field	Subfield	Entry	Explanation and action
			<p>Note: The value of field MTPRES is the same for all tuples of network types ANSI7, CCITT7 and NTC7. If an attempt is made to change a tuple with a different value of MTPRES to network types ANSI7, CCITT7 or NTC7 the following message appears.</p> <p>WARNING</p> <p>MTPRES has been changed for all network types that support MTP restart.</p> <p>Note: The value of field MTPRES must be set to N for network types JNP7 and TTC7. If an attempt is made to add a MTPRES field set to Y the following message will be issued.</p> <p>WARNING</p> <p>MTP restart is not supported for this network type, MTPRES must be set to N.</p>
PACERATE		0 to 10	<p>For ANSI STP networks, enter a value from 0 to 10. These values, expressed in tenths of a second, represent the pacing rate used when pacing transfer-allowed (TFA) / transfer-cluster-allowed (TCA) messages. The default value is 10. For non-ANSI and non-STP networks the default value is 0 and cannot be changed.</p>

Datafill example

The following example shows sample datafill for table C7NETWRK.

C7NETWRK (continued)

MAP display example for table C7NETWRK

NETNAME	NODETYPE		SLSROT	TFR	MCS	PTCODE
	NI					CLUSTERS
	RCTEST	MTPRES	PACERATE			
NATL_NET	SSP_STP		ANSI7	171	1	0
		NATL	Y	Y	3	Y
	Y	Y	10			
NATLSP_NET	SSP_STP		ANSI7	173	1	0
		NATLSPARE	Y	Y	3	Y
	Y	Y	10			
INTL_NET	SSP_STP		ANSI7	172	1	0
		INTL	Y	Y	3	Y
	Y	Y	10			
		ANSI7	2	2	2	
INTLSP_NET	SSP_STP		ANSI7	174	1	0
		INTLSPARE	Y	Y	3	Y
	Y	Y	10			

MAP display example for table C7NETWRK in a DMS-SSP or DMS-STP

NETNAME	NODETYPE		SLSROT	TFR	MCS	PTCODE
	NI					CLUSTERS
	RCTEST	MTPRES	PACERATE			
STPNET	STP		ANSI7	240	248	16
	NATL		Y	Y	3	Y
	Y	Y	10			
SSPNET	SSP		ANSI7	240	248	18
	NATL		Y	Y	3	Y
	Y	Y	10			

C7NETWRK (continued)

MAP display example for table C7NETWRK when USP_ACTIVE_IN_NETWORK is set to Y

NETNAME	NODETYPE			PTCODE		
	NI	SLSROT	TFR	MCS	CLUSTERS	
	RCTEST	MTPRES	PACERATE			
NEW_TESTNET	SSP	ANSI7	240	248	16	
	NATL	Y	Y	3	Y	
	N	N	N			

Table history**CSP18/SN05**

Added field SLSENH for SLS enhancements to non North American (CCITT) SSP markets using ITU signaling for feature 19013269.

MMP15

Added FORMAT TURK for feature 59022376.

MSH14

Information message added to direct the user to the USP GUI for access to table data when office parameter USP_ACTIVE_IN_NETWORK is set to Y.

STP05

Modified table C7NETWRK as follows:

- Increased table size to 16 tuples.
- Allowed multiple STP nodes to be datafilled in the same NI.
- Allowed STP nodes with the same NI to have different network types.
- Added five messages to ensure the proper use of SEAS support for multiple point code (MPC) function.

STP04.1

The following changes were introduced:

- Added format INTL2 with the following refinements: NETWORK, REGION, GROUP, and MEMBER.
- Added field PACERATE.

TL07

Added note to SLSROT field for ANSI networks.

C7NETWRK (continued)

TL06

Added field NODE TYPE. Updated error messages to include restrictions for MNA7 capability.

TL05

Added field MTPRES.

CSP02

Explanatory text clarified for modifying tuples in the “Supplementary information” section.

STP02

Added NETTYPE NTC7 and its refinements.

Supplementary information

This section provides additional information on datafilling table C7NETWRK.

If STP Signaling, Engineering, and Administration System (SEAS) software is present in the load, the following restrictions apply:

- The name selected to represent the network name (field NETNAME) must be exactly 11 characters. If an attempt is made to datafill a name that is not 11 characters, the tuple is rejected and the following error message is displayed:

Example of a MAP display:

```
SEAS IS PRESENT ON THE STP. NETNAME MUST BE 11 CHARACTERS.
```

- If the network being datafilled has a network indicator (field NI) of NATL and a network type (field NETTYPE) of ANSI7, the network name (field NETNAME) must consist of the last 11 characters of office parameter SEAS_UAL_STP_NODE_NAME in table OFCENG. If it does not, the tuple is rejected and the following error message is displayed:

Example of a MAP display:

```
SEAS IS PRESENT ON THE STP. NETNAME MUST BE <nnnnnnnnnnnn>.
```

In the actual error message displayed, the character string depicted as <nnnnnnnnnnnn> is replaced with the first 11 characters of office parameter SEAS_UAL_STP_NODE_NAME in table OFCENG.

Note: If MPC (TEL00012) is active, this restriction applies only to the first ANSI7 NATL tuple.

C7NETWRK (continued)

If MNA7 capability is present in the load, the following restrictions apply:

- When a tuple is added to table C7NETWRK, its type is verified against “C7_current_node_type”. The node type supports SSP, STP, SCP or any combination. The following is an example of the node type that is displayed when an incorrect node type is added or modified:

Example of a MAP display:

```
The network node type must be a subset of the office node
type. The office node type is an SSP.
```

- If the node type within a tuple is being changed, a check is performed against the link types datafilled in table C7LKSET. Only the transition from SSP to/from SSP/STP is allowed. The following error message is displayed if the transition is not allowed:

Example of a MAP display:

```
The node type change is not a valid transition.
```

- Tuples with the same NI must be the same network type. The following error message is displayed:

Example of a MAP display:

```
Tuples with the same network indicator must contain the same
network type.
```

- Depending on the previously datafilled tuple of the same NI, one of the following messages is displayed:

Examples of a MAP display:

```
Expecting CCITT Standard network type.
Expecting ANSI Standard network type.
Expecting NTC Standard network type.
Expecting Japan TTC Standard network type.
Expecting Japan Public Standard network type.
```

- The OPC for each tuple with the same NI cannot be the same. Other tuples with a different NI within table C7NETWRK can have the same OPC data filled. If the OPC for a tuple is identical to the NI, the following error message is displayed:

Example of a MAP display:

```
The point code is already in use for the given network
indicator.
```

- When you first datafill multiple network addresses, software optionality control (SOC) must be enabled. If SOC is not enabled, you can only

C7NETWRK (continued)

activate links within one node of the two nodes with the same NI. If you have not enabled SOC, the following warning message is displayed:

Example of a MAP display:

```
WARNING:  Datafill for multiple network addresses will be
created.
```

Only one network can contain active links if MNA7 SOC is not enabled.

- MNA7 tuples cannot be datafilled in a network if those tuples are datafilled in GATEPC tables. MNA7 tuples exist if two or more C7NETWRK tuples contain the same NI.
- The last tuple with a specific NI cannot be deleted if the NI contains a tuple in table GATEPC.
- Only one node of the same type can be datafilled for a network. You cannot have two STP nodes in the same network. If you attempt to datafill two nodes in the same network, the following error message is displayed:

Example of a MAP display:

```
The node type is already in use for the given network
indicator.
```

Note: The above restriction does not apply when MPC (TEL00012) is active.

- When MPC (TEL00012) is active, the maximum number of nodes for each network is 16. If this limit is exceeded, the following error message is displayed:

Example of a MAP display:

```
The maximum number of STP nodes already exists for the given
NI.
```

- The maximum number of SSP nodes in a network is one. An SSP and an INode cannot exist under the same NI as they are considered to be alike. The following error message is displayed:

Example of a MAP display:

```
Only one node with SSP capability is supported for a given
network indicator.
```

Note: The above restriction does not apply when MPC (TEL00012) is active.

C7NETWRK (continued)

- A network must contain only an SSP, STP or SSP/STP node type. An SSP/STP is considered to be an SSP node. Therefore, an SSP/STP and STP combination is a valid set, but an SSP/STP and SSP is not.
- The only transitions allowed when changing node types are changing an SSP to an SSP/STP, and changing an SSP/STP to an SSP.
- STP nodes must only contain A, B, C, D, or E links.
- SSP/SCP nodes must only contain A, E, or F links.
- An SSP or a service control point (SCP) do not support all linksets supported by an STP. The node type cannot be modified if the new node type does not support the links datafilled in table C7LKSET. The following error message is displayed:

Example of a MAP display:

An SSP or SCP cannot support the B, C, or D link type defined in table C7LKSET.

- An STP does not support all linksets supported by other node types. The node type cannot be modified if the new node type does not support the links datafilled in table C7LKSET. The following error message is displayed:

Example of a MAP display:

An STP cannot support the F link type defined in table C7LKSET.

- An SSP and STP does not support all linksets supported by other node types. The node type cannot be modified if the new node type does not support the links datafilled in table C7LKSET. The following error message is displayed:

Example of a MAP display:

An INode cannot support the F link type defined in table C7LKSET.

- Tuples in table C7NETWRK with the same NI will be verified to have the same point code format. A warning message indicates if there is an incorrect point code format.
- If you attempt to add a multiple STP entry to an NI with an unsupported network type, the following error message is displayed:

Example of a MAP display:

The following network types are only supported for multiple STP nodes per NI: ANSI, ITU and NTC7.

C7NETWRK (continued)

- When the multiple point code (MPC) SOC (TEL00012) is on, you can add national ANSI networks to table C7NETWRK. However, if the name of the network you add does not match the office parameter SEAS_UAL_STP_NODE_NAME, SEAS displays a warning message to indicate that SEAS cannot interact with the added network.

Example of a MAP display:

```
Warning: Network name does not match the office parameter
SEAS_UAL_STP_NODE_NAME. SEAS cannot interact with this
network.
```

- When you perform a one-night process (ONP), SEAS displays a warning message when there is no national ANSI network name in table C7NETWRK that matches the office parameter SEAS_UAL_STP_NODE_NAME.

Example of a MAP display:

```
Warning: Office parameter does not match a NATL, ANSI network
name in table C7NETWRK. SEAS will not function with any
network.
```

- If you attempt to use the C7RENAME command to rename a network in table C7NETWRK that is not a national ANSI network to the same network name in office parameter SEAS_UAL_STP_NODE_NAME, the system displays the following error message:

Example of a MAP display:

```
Error: Non-ANSI, non-NATL networks cannot have network names
that match the office parameter SEAS_UAL_STP_NODE_NAME.
```

- If the network you attempt to add to table C7NETWRK from the MAP terminal is not a national ANSI network, and has the same network name as office parameter SEAS_UAL_STP_NODE_NAME, the system displays the following error message:

Example of a MAP display:

```
Error: Non-ANSI, non-NATL networks cannot have network names
that match the office parameter SEAS_UAL_STP_NODE_NAME.
```

- If the network name you attempt to change in office parameter SEAS_UAL_STP_NODE_NAME matches a network name in table C7NETWRK that is not a national ANSI network, the system displays the following error message:

C7NETWRK (continued)

Example of a MAP display:

Error: Office parameter must belong to an ANSI, NATL network.

- If office parameter USP_ACTIVE_IN_NETWORK is set to Y, the system displays the following message when you try to add, delete, or change a tuple:

Example of a MAP display:

```
*****
*                               WRITE ACCESS DENIED                               *
*****
****
** The USP is now used to administer the SS7 data.
**
** Network information can only be displayed for this table.
**
**                                                                 **
** Go to the GUI on the USP to modify this data.
**
*****
****
```

Adding a network to table C7NETWRK

To add a network to table C7NETWRK, the following information must be specified:

- the name of the network
- the type of network
- the office's OPC
- a unique network indicator that is unique to the network
- whether SLS rotation is used
- the number of congestion levels used
- if clustering is a part of the network messaging protocol
- if MTP is enabled or disabled for the network

Modifying a network in table C7NETWRK

Only fields SLSROTAT, TFR, CLUSTERS, RCTEST, MTPRES, and PACERATE can be modified in table C7NETWRK. All other fields require that the network be deleted and re-added with the new data. Many tables in CCS7 are dependent on the data in table C7NETWRK, so that the rules for modifying any fields other than those listed are the same as for deleting a network.

C7NETWRK (end)

Deleting a network from table C7NETWRK

A network cannot be deleted until all linksets and routesets have been deleted from that network. Use table control to delete linksets and routesets from tables C7LKSET and C7RTESET.

Additional dependencies apply when deleting linksets and routesets. Refer to the table descriptions for tables C7LKSET and C7RTESET.

C7ROUTER

Table name

C7 Router (C7ROUTER)

Functional description

The C7 Router (C7ROUTER) table allows for the datafill of Common Channel Signaling System #7 (CCS7) Routers. If external routing for an office is enabled, the DTC7s designate LIU7s as routers.

This table is updated when LIU7 routers are added, modified, or deleted.

The Routeset Expansion Phase II (RSX2) feature allows adding routers to the table or deleting routers from the table without considering the PM state of an LIU7. However, the router state is set to offline after being added to the table. Also, the router state must be offline before deleting the router from this table. Three new commands, Bsy, RTS, and OffL, at the C7ROUTER MAP level are used with this feature.

The RSX2 feature also allows a router to exist in a state that is independent of its resource state or the state of the LIU7 PM. The router states include:

- InSv (In Service) The router is returned to service either manually or by the system, and the router is performing the routing function for the CCS7 DTCs.
- ISTb (In Service Trouble) The router is capable of performing the routing function but is facing congestion due to high CCS7 traffic levels. Messages are being discarded.
- ManB (Manually Busy) The router is manually busied and is not performing the routing function for the CCS7 DTCs.
- OffL (Off Line) The state of a router after being added to the C7ROUTER table. It is also the required state to delete a router from the table.
- SysB (System Busy) The router is busied by the system and is not performing the routing function for the CCS7 DTCs.
- UnEq (Unequipped) The router is not datafilled in the C7ROUTER table.

The table requires a minimum of two routers to activate external routing. The maximum number of routers is eight.

Datafill sequence and implications

Table LIUINV must be datafilled before table C7ROUTER.

C7ROUTER (end)**Table size**

Memory is allocated for a maximum of 32 tuples in table C7ROUTER.

Field descriptions

The following table describes field names, subfield names, and valid data ranges for table C7ROUTER.

Field	Subfield or refinement	Entry	Explanation and action
RTRNUM		1 -32	ROUTER NUMBER. This is the key field for this table. It uniquely identifies a router.
RESOURCE			RESOURCE. This field specifies the resource used as a router.
	PMTYPE	LIU7	PERIPHERAL MODULE TYPE. This field specifies the type of peripheral module being used as a router. For current implementation, datafill as LIU7.
	LIU7INDEX	0 - 511	LIU7 INDEX. This field is the index of an LIU7. Enter the index of the LIU7.

Datafill example

The following example shows datafill for table C7ROUTER.

RTRNUM	RESOURCE
1	LIU7 101
5	LIU7 103
24	LIU7 106
31	LIU7 107

C7RPLSSN

Table name

CCS7 Replicate Subsystem Table

Functional description

Table C7RPLSSN provides the set of remote subsystem replicate pairs or replicate groups. It has a one-part key, the subsystem name. For each subsystem a list of point codes (PC) at which the replicated subsystems reside must be given.

Replicate nodes for a subsystem name, datafilled as a replicate pair, define those two nodes as replicates of each other. Subsequent replicate pairs for the same subsystem name are not replicates of the original pair. Replicate nodes for a subsystem name, datafilled as a replicate group, define the replicate nodes within the group as replicates of each other. Subsequent replicate groups datafilled for the same subsystem name are not replicates of the original replicate group.

A set of replicate pairs and replicate groups under the same subsystem name are mutually exclusive. CCS7 translation information for a set of replicate pairs is datafilled in CCS7 translation tables such as C7GTT and CCS7. Translation information for a set of replicate groups is datafilled in table C7GTRSLT only.

If loadsharing is required between a replicated pair datafilled in table C7RPLSSN, both members of the pair also must be datafilled in table C7GTT as results with equal cost. If both results are datafilled in C7GTT with different costs, then the one with the lower cost will carry all traffic and the other will serve as a backup only.

For related information, refer to table C7NETSSN.

Adding a subsystem to table C7RPLSSN

To add a subsystem replicate pair to table C7RPLSSN, the following information is required:

- the subsystem name. The values of the UNKNOWN subsystem and SCMG are invalid.
- the list of PCs at which the replicate subsystems reside
- the corresponding subsystem at the given PCs, which must be datafilled in table C7NETSSN. The traffic mix information must be specified for each replicate pair.

C7RPLSSN (continued)

To add a subsystem replicate group to table C7RPLSSN, the following information is required:

- the subsystem name. The values of the UNKNOWN subsystem and SCMG are invalid
- the list of PCs at which the replicate subsystems resides
- the corresponding subsystem at the given PCs, which must be datafilled in table C7NETSSN

Note: The traffic mix information is not specified for replicate groups in field GRPLIST.

Modifying a subsystem in table C7RPLSSN

The list of replicated subsystem pairs, as defined by a pair of PC names where the subsystem resides, can be modified. A new list of replicate pairs is entered, repeating those that have not changed and adding any new pairs. The subsystems in these pairs must be datafilled at the PC given in table C7NETSSN.

The list of replicated groups, as defined by a group of PC names where the subsystem resides, can be modified. A new list of replicate groups is entered, repeating those that have not changed, adding or deleting any replicates to existing groups, or adding or deleting any replicate groups. The subsystems in these groups must be datafilled at the PC given in table C7NETSSN.

The following fields can be modified:

- REPL_SET_INFO The PC name of the replicate within a group can be deleted or modified only if there are no GTTs in table C7GTRSLT that result in the replicate.
- REPL_NODE1 The first PC name of the replicate can be deleted or modified only if there are no GTTs in the CCS7 translation tables that result in the replicate pair.
- REPL_NODE2 The second PC name of the replicate can be deleted or modified only if there are no GTTs in the CCS7 translation tables that result in the replicate pair.
- TFMI_USERS The flag, indicating whether signaling connection control part (SCCP) management generates subsystem backup routing (SBR) and subsystem normal routing (SNR) messages used for traffic mix information for this replicate, can be changed.

C7RPLSSN (continued)

Deleting a subsystem from table C7RPLSSN

The set of replicate pairs in field REPLIST for a given subsystem, can be deleted only if there are no GTTs in the CCS7 translation tables that result in any of the replicate pairs for this subsystem.

The set of replicate pairs for a given subsystem can be deleted without requiring that the affected subsystems be offline.

A set of replicate groups in field GRPLIST for a given subsystem can be deleted only if there are no GTTs in table C7GTRSLT that result in any of the replicates in any of the replicate groups for this subsystem.

The set of replicate groups for a given subsystem can be deleted without requiring that the affected subsystems be offline.

Datafill sequence and implications

The following tables must be datafilled before table C7RPLSSN

- C7NETSSN Each network subsystem defined as a member of a replicate pair DRU="STP">or replicate group must be defined in table C7NETSSN before it is datafilled in table C7RPLSSN.
- C7LOCSSN

Table C7GTT is datafilled after table C7RPLSSN if more than one result is used for a single GT range. DRU="STP"> Table C7GTRSLT is datafilled after table C7RPLSSN if any PCSSN result types, including NEWGT, are datafilled.

Table size

0 to 256 tuples

The maximum number of tuples allowed in this table is fixed to the maximum number of subsystems defined.

C7RPLSSN (continued)**Datafill**

The following table lists datafill for table C7RPLSSN

Field descriptions (Sheet 1 of 4)

Field	Subfield or refinement	Entry	Explanation and action
SSNAME		see below	<i>Subsystem name</i> The subsystem names can be from one to eight characters in length. A predefined subsystem name entry is taken from table C7NETSSN, field PCSSN. A signaling connection control part (SCCP) user is known as a subsystem. The meanings of the predefined subsystem names are as follows:
		800P	800P (Canadian version of CCS7 800 Service [800 Plus] 800P is provided if feature package NTX555AB [800 Plus] is in the switching unit. Otherwise, E800 is provided.)
		ACCS	Enter ACCS to specify the automatic calling card service subsystem.
		ACCTSS	Enter ACCTSS to specify the account code validation subsystem.
		AUTHSS	Enter AUTHSS to specify the authcode verification subsystem.
		BNS	Enter BNS to specify the billing number screening subsystem.
		CMS	Enter CMS to specify the call management service subsystem. Note: Entry CMS is Canada only.
		CNAMD	Enter CNAMD to specify the Custom Local Area Signaling Service (CLASS) Calling Name Delivery (CNAMD) subsystem.
		CS1R	Enter CS1R to specify the Capability Set 1 (CS1) subsystem.
		E800	Enter E800 to specify the Enhanced 800 service subsystem.

C7RPLSSN (continued)

Field descriptions (Sheet 2 of 4)

Field	Subfield or refinement	Entry	Explanation and action
		INTERWRK	Enter INTERWRK to specify the subsystem used for features that are interworked between primary rate access (PRA) and SS7.
		ISDNUP	Enter ISDNUP to specify the ISDN user part subsystem.
		N00	Enter N00 to specify the N00 calling service subsystem.
		NMS	Enter NMS to specify the network message service subsystem.
		NSSTCN	Enter NSSTCN to specify the network services software (NSS) travel card number.
		OAM	Enter OAM to specify the operations, administration, and maintenance subsystem.
		OLNS	Enter OLNS to specify originating line number screening.
		PVN	Enter PVN to specify the private virtual network subsystem.
		REPLDIGS	Enter REPLDIGS to specify the NSS database control point DBCP replace dialed digits application.
		RTRS	Enter RTRS to specify the TOPS real-time rating system.
		SCPACCS	Enter SCPACCS to specify the ACCS database (SCP) subsystem.
		SCPBNS	Enter SCPBNS to specify the BNS database (SCP) subsystem.
		SCPE800	Enter SCPE800 to specify the E800 database (SCP) subsystem.
		TCN	Enter TCN to specify the travel card service subsystem.
		TOPSLNP	Enter TOPSLNP to specify the TOPS local number portability

C7RPLSSN (continued)

Field descriptions (Sheet 3 of 4)

Field	Subfield or refinement	Entry	Explanation and action
REPLIST		TUP	Enter TUP to specify the telephone user part subsystem.
		see subfields	<p><i>Replicate list</i></p> <p>This field is a vector of up to 12 replicated pairs. If fewer than 12 pairs are required, end the list with a \$ (dollar sign). Each member of the list represents a pair of point code (PC) names, the PCs where each member of the replicated pair resides, and a flag indicating whether signaling connection control part (SCCP) management generates subsystem backup routing (SBR) and subsystem normal routing (SNR) messages used for traffic mix information for this replicated pair.</p> <p>Datafill the first part of the pair in subfield REPL_NODE1, the second part of the pair in subfield REPL_NODE2, and the traffic mix information in subfield TFMI_USERS.</p> <p>Note: REPL_NODE1 and REPL_NODE2 entries must be the same network type. For example, if REPL_NODE1 is an ANSI routeset and REPL_NODE2 is a CCITT routeset, the tuple is incorrect and results in an error message.</p> <p>Note 1: REPL_NODE1 and REPL_NODE2 entries must be the same node type. For example, if REPL_NODE1 is an SSP routeset and REPL_NODE2 is an SSP/STP routeset, the tuple is incorrect and results in an error message.</p> <p>Note 2: Routing information for the subsystem at the given PC must first be datafilled in table C7NETSSN.</p>

C7RPLSSN (continued)

Field descriptions (Sheet 4 of 4)

Field	Subfield or refinement	Entry	Explanation and action
GRPLIST	REPL_NODE1	alphanumeric (1 to 16 characters)	<p><i>Replicate node one</i> Enter the first PC name of the replicate at which the replicate subsystem resides.</p> <p>Note: The PC must be datafilled in table C7NETSSN with the subsystem given in field PCNAME.</p>
	REPL_NODE2	alphanumeric (1 to 16 characters)	<p><i>Replicate node two</i> Enter the second PC name of the replicate at which the replicate subsystem resides.</p> <p>Note: The PC must be datafilled in table C7NETSSN with the subsystem entered in field PCNAME.</p>
	TFMI_USERS	Y or N	<p><i>Traffic mix information users</i> Enter Y (yes) if SCCP management generates SBR and SNR messages used for traffic mix information for this replicate pair. Otherwise, enter N (no).</p>
		see subfields	<p><i>Group list</i> This field is a vector of up to six replicate groups. Each group contains up to 16 replicated nodes. If fewer than six replicate groups are required, end the list with a \$ (dollar sign). If fewer than 16 replicate nodes within a group are required, end the list with a \$.</p> <p>Note: The TFMI indicator can not be datafilled for replicate groups.</p>
	REPL_SET_INFO	alphanumeric (1 to 16 characters)	<p><i>Replicate node</i> Enter the PC name at which the node resides.</p> <p>Note 1: The PC must be datafilled in table C7NETSSN with the subsystem entered in field PCNAME.</p> <p>Note 2: All entries in a replicate group must be the same network type.</p>

C7RPLSSN (continued)**Datafill example**

The following example shows sample datafill for table C7RPLSSN.

MAP display example for table C7RPLSSN

SSNAME	REPLIST	GRPLIST
ACCS	(SCP3 SCP4 N)\$	((SCP5) (SCP6) (SCP7) \$) \$

For further information and datafill examples, see table C7NETSSN.

Table history**TOPS07**

Value TOPSLNP added to field SSNAME by feature AF6549.

STP04

Field GRPLIST is added.

GL03

Value CS1R added to field SSNAME.

CSP06

Value OLNS added to field SSNAME by feature AN1564 in functionality TOPS OLNS Interface, ABS00012.

CSP04

Added value RTRS to field SSNAME per feature AN1504 in functionality External RTRS Interface, ENSV0009

BCS36

Reference in subfield SSNAME to BCS30 was removed. Subsystem CNAMD was added to field SSNAME.

C7RPLSSN (end)**Supplementary information**

The following table lists responses to table C7RPLSSN datafill.

MAP responses

Response	Explanation	User action
There must be at least one entry in field REPLIST or field GRPLIST.	The addition of a tuple with an empty REPLIST and GRPLIST field.	Datafill field REPLIST or GRPLIST or both fields.
The members of field GRPLIST must be unique.	Addition or modification of a PC name to a replicate group that is not unique from all other PC names in all other replicate groups for a SSNAME.	Modify or delete the PC name.
Replicates must be from the same network in C7NETWRK.	Modification of a PC name to a replicate group using a different network than the existing PC names of the group.	Delete the PC name from the group.
All in use replicates must remain together in a replicate group.	The addition or removal of a PC name that is in use from a replicate group that contains in-use PC names.	Delete or add the in use PC name from or to the replicate group that contains in use PC names.
The replicate is a result of the C7GTRSLT table.	The deletion of a PC name from a replicate group that is in use by table C7GTRSLT.	Delete the appropriate results from table C7GTRSLT.
The replicate pair is used by the CCS7 translation tables.	Deletion of a replicate pair, in field REPLIST, that is in use by the CCS7 translation tables.	Delete the appropriate results from the CCS7 translation table.

C7RSSCRN

Table name

Common Channel Signaling 7 Remote Subsystem Concerned Node Table

Functional description

Table C7RSSCRN provides a list of concerned nodes for a remote subsystem point code combination. The table has a two part key. The first part is the point code (PC) and the second part is the subsystem name. The PC and subsystem combination must be datafilled in table C7NETSSN.

The concerned node list is a list of PC names that must each be datafilled in table C7NETSSN.

For related information, refer to table C7NETSSN.

Adding a tuple to table C7RSSCRN

To add a tuple to table C7RSSCRN the following information is required:

- a remote PC and subsystem combination
- a list of PC names (concerned nodes) that need to know when the PC and subsystem changes state

Modifying a tuple in table C7RSSCRN

The list of concerned nodes in field PCNAMES can be modified. To modify the list of concerned nodes, repeat those that have not changed and add any new nodes.

Datafill sequence and implications

Table C7NETSSN must be datafilled before table C7RSSCRN.

Table C7RSSCRN depends on table C7NETSSN. Each PC and subsystem key must be datafilled in table C7NETSSN and each entry in field PCNAMES (the concerned node list) must also be datafilled in table C7NETSSN.

Table size

0 to 256 tuples

Table size is limited by the number of PC and subsystem combinations datafilled in table C7NETSSN.

C7RSSCRN (continued)**Datafill**

The following table lists datafill for table C7RSSCRN.

Field descriptions (Sheet 1 of 2)

Field	Subfield or refinement	Entry	Explanation and action
PCSSN		see subfields	<i>Point code subsystem combination</i> This field consists of subfields PCNAME and SSNAME.
	PCNAME	alphanumeric (1 to 16 characters)	<i>Point code name</i> Enter the common language location identifier (CLLI) of the remote point code (PC) for which the concerned node list applies.
	SSNAME	800P, ACCS, ACCTSS, AIN01, AIN02, AUTHSS, BNS, CMS (see note), E800, INTERWRK, ISDNUP, N00, NMS, NSSTCN, OAM, PVN, REPLDIGS, SCPACCS, SCPBNS, SCPE800, TCN, or TUP	<p><i>Subsystem name</i>The subsystem names can be from one to eight characters in length. A pre-defined subsystem name entry is taken from table C7NETSSN, field PCSSN. The meanings of the predefined subsystem names are as follows:</p> <p>800P (Canadian version of CCS7 800 Service (800 +) 800P is provided if feature package NTX555AB (800 Plus) is in the switching unit. Otherwise, E800 is provided)</p> <p>ACCS (Automatic Calling Card Service)</p> <p>ACCTSS (account code validation)</p> <p>AIN01 (AIN essentials)</p> <p>AIN02 (AIN service enablers)</p> <p>AUTHSS (authcode verification)</p> <p>BNS (billed number screening)</p> <p>CMS (Call Management Service)</p> <p>Note: Canada only</p> <p>E800 (Enhanced 800 Service)</p> <p>INTERWRK (used for features interworked between primary rate interface [PRA] and Signaling System 7 [SS7])</p>

C7RSSCRN (continued)**Field descriptions (Sheet 2 of 2)**

Field	Subfield or refinement	Entry	Explanation and action
	SSNAME (continued)		ISDNUP (ISDN user part) N00 (N00 calling service) NMS (network message service) NSSTCN (network services software [NSS] travel card number) OAM (operations, administration, and maintenance) PVN (private virtual network) REPLDIGS (NSS database control point [DBCP] replace dialed digits application) SCPACCS (ACCS database switching control point [SCP]) SCPBNS (BNS database [SCP]) SCPE800 (E800 database [SCP]) TCN (travel card service) TUP (telephone user part)
PCNAMES		vector of up to 8 PCs	<i>Remote concerned node list</i> This field is a vector of up to eight PC names. This field contains a list of nodes that are kept informed of status changes at the remote subsystem. The PCs must be datafilled in table C7NETSSN. If less than eight names are required, end the list with a \$ (dollar sign).

Datafill example

The following example shows sample datafill for table C7RSSCRN.

C7RSSCRN (end)

MAP display example for table C7RSSCRN

PCSSN	PCNAMES
ANSIRTSABC ACCS	(ANSIRTSCBA)\$

Table history

NA007

Value AIN02 added to field SSNAME by feature AJ4099.

Value TOPSLNP added to field SSNAME by feature AF6549.

BCS36

Reference in subfield SSNAME to BCS30 was removed.

C7RTESET

Table name

CCS7 Routeset Table

Functional description

Table C7RTESET supports a logical association between linksets that are used as possible routes for each signaling point in the network. An office point code uniquely identifies a signaling point within any network. Each office point code must have a routeset. The information in this table records which routesets and linksets can carry the signaling information to the destination signaling point. This table is also used for alternative routing decisions.

Note: When office parameter USP_ACTIVE_IN_NETWORK is set to Y, you can display tuple information. Attempts to add, delete, or change a tuple in this table using the DMS table editor generates a message referring you to the Graphical User Interface (GUI) on the Universal Signaling Point (USP) for proper access to data for this table.

Signaling transfer points (STP) must have a routeset datafilled, regardless of whether any user parts terminate messages at the STP. This enables each linkset to identify the routeset that delivers messages to its far end.

Note: All references to signaling transfer point (STP) are applicable to the DMS integrated nodes (INode), unless otherwise specified.

Table C7RTESET is keyed on the name of the routeset. Because a routeset name is unique only within the network in which it is defined, the network name must be specified. Textual names provide a convenient way of representing the routeset name. The actual destination must also be specified. The destination point code (DPC) depends upon the network type that is chosen.

If it is possible to receive transfer messages for certain clusters, datafill those clusters with their own unique routeset. This datafill improves the handling of status messages for those clusters, allowing the LOG and OM systems to identify affected clusters. If a cluster does not have its own routeset, the remote service module (RSM) treats a cluster message as a group of destination-oriented messages.

A list of up to six linksets, in priority order, one at a time, can be specified to define a particular routeset. The order defines the sequence in which a signaling linkset is chosen for signaling to the DPC.

C7RTESET (continued)

A route is described by the linkset name and by a cost that is relative to this routeset. The cost is a value between 0 and 99. To specify a combined linkset, define two routes with the same cost.

It is the relative value of the cost that is important, rather than the value itself. When defining routes with respect to the cost, each route must have a cost equal to or greater than the cost of the route that was defined before it.

Routeset expansion is available for the SSP, STP, and DMS-INodes. The routeset limit for each of these nodes is 2K. Routeset expansion is SOC controlled and can be set to 255, 511, 767, 1023, 1279, 1535, 1791, or 2047.

External routing must be enabled on the SSP and DMS-INodes when the routeset tuples exceed 255.

Interaction of table C7RTESET and table C7LKSET

The default route mode of an added routeset tuple is QUASI. If the far-end point code (FEPC) of a linkset in table C7LKSET has the same point code as the added routeset, the linkset appears as a route in the routeset, and if the route has a unique cost so that it is not part of a combined linkset, then the added routeset assumes the mode ASSOC and functions in the same manner as routes that are explicitly datafilled as ASSOC.

If a tuple in table C7LKSET is changed and the FEPC is also changed, all routesets defined in C7RTESET are checked. If an ASSOC route has been formed with the linkset and if the corresponding routeset is offline, then the route becomes a QUASI route. A search is initiated for the routeset whose DPC matches the changed FEPC of the linkset. The route becomes the ASSOC route in the routeset.

Note: A linkset in a combined linkset cannot be implicitly made into the ASSOC route.

Route changes in a routeset tuple can cause the mode of a route (linkset) to change. Linksets that can change from ASSOC to QUASI or QUASI to ASSOC must be offline or the change is disallowed.

Adding a routeset to table C7RTESET

In order to add a routeset, the following information is required:

- a 1-to-16-character name that identifies the routeset. This name is defined in table C7RTESET.
- the name of the network to which the routeset is added. The network name must be defined in table C7NETWRK before adding a routeset.

C7RTESET (continued)

- the network type, as defined in table C7NETWRK
- whether a transfer prohibited (TFP) or a transfer cluster prohibited (TCP) message is broadcast to all adjacent signaling points (if the switching unit is an STP)
- the point code of the destination office to which the routeset establishes signaling paths. The point codes must be unique within the network.
- the name of the linksets added to the routeset, listed in order of priority. These linksets are first defined in table C7LKSET.

The following restrictions apply when adding a routeset:

- When datafilling a routeset, at least one route (LINKSET) must be datafilled.
- The message switch and buffer (MSB) of the linkset must be defined, for example, it must have at least one link in it.
- The linkset must be on the same network as the routeset.
- The routes (linkset) selected must be on the same MSB as the routeset.
- There can be a maximum of six routes in a routeset.
- A route cannot be added twice to the routeset.
- All routes entered must be unique within the routeset.
- Only the first route of any routeset can be an associated route. This is a system restriction.

Modifying a routeset in table C7RTESET

To modify a routeset, the routeset must first be taken offline. The routeset is keyed on the routeset name.

The exception occurs when attempting to delete a higher cost route from a routeset. If the linkset of the higher cost route is offline, you can delete the route without taking the routeset offline.

The DPC cannot be changed in order to modify this field. The routeset must be deleted and re-added with the new DPC.

The network name cannot be changed. The routeset must be deleted and re-added with a new name.

To change the linksets in the routeset, a new list of linksets is entered. The linksets are listed in order of priority. The conditions and restrictions that apply to adding a routeset in table C7RTESET also apply to modifying a

C7RTESET (continued)

routeset in table C7RTESET. Refer to the previous section, "Adding a routeset to table C7RTESET".

Deleting a routeset from table C7RTESET

Before deleting a tuple from table C7RTESET, delete all references to the routeset from the following tables in the following order.

1. C7GTT
2. C7GTTTYPE
3. C7RPLSSN
4. C7LOCSSN
5. C7RSSCRN
6. C7NETSSN
7. C7TRKMEM

After deleting all references to the routeset, take the routeset offline. The routeset must be identified by a routeset name.

A routeset can be deleted without deleting the linksets defined within it. Linksets may be a part of many routesets.

Datafill sequence and implications

The following tables must be datafilled before table C7RTESET.

- C7LKSET
- C7NETWRK

Table size

0 to 255 tuples without external routing.

0 to 511 with external routing enabled (for JPN-ISUP C7Routeset Expansion limitation configurations only).

0 to 2047 tuples for expanded routesets in an SSP office, a CCS7 multiple network address (MNA7) DMS INode, or an STP.

Note 1: Expanded routeset capability is controlled by software optionality control (SOC). Refer to the *Software Optionality Control User Manual*, 297-8991-901, for more information on using SOC.

Note 2: External routing must be enabled when more than 255 routeset tuples are required for the SSP or INode.

C7RTESET (continued)

Memory allocation is fixed for the maximum table size.

Datafill

The following tables list datafill for table C7RTESET.

Field descriptions (Sheet 1 of 3)

Field	Subfield or refinement	Entry	Explanation and action
ROUTESET		see subfield	<i>Routeset key</i> This field, which is the key to table C7RTESET, consists of subfield DESTNAME.
	DESTNAME	alphanumeric (1 to 16 characters)	<i>Routeset name</i> Enter a routeset name that is unique to the switching office. A routeset describes a collection of routes within a specific network.
NETNAME		alphanumeric (1 to 16 characters)	<i>Network name</i> This field identifies the network to which a destination point code (DPC) corresponds. Enter a network name that is unique to the switching office. This name must be previously datafilled in table C7NETWRK. CCS7 linkset names can be numeric character strings. For example, a network can have the name of 99 999. To post a numerically named linkset at the appropriate MAP level, the name must be enclosed in single quotation marks (` `). For numerically named linksets that are longer than seven characters, no quotation marks are required, for example, linkset name 12345678 requires no quotation marks to post the linkset at the MAP level.

C7RTESET (continued)

Field descriptions (Sheet 2 of 3)

Field	Subfield or refinement	Entry	Explanation and action
TFPBCAST		Y or N	<p><i>Transfer prohibited broadcast</i></p> <p>This field determines if a transfer prohibited (TFP) or transfer cluster prohibited (TCP) message is broadcast to all adjacent signaling points when the routeset becomes unavailable.</p> <p>If the switching unit is a signaling transfer point (STP) and a TFP or TCP must be broadcast to adjacent signaling points when the routeset becomes unavailable, enter Y.</p> <p>If no TFP or TCP broadcast is required or if the switching unit is not an STP, enter N. For Japan Public Network 7 (JPN7) networks, the only valid entry is N.</p>

C7RTESET (continued)

Field descriptions (Sheet 3 of 3)

Field	Subfield or refinement	Entry	Explanation and action
DPC		see subfields	<p><i>Destination point code</i></p> <p>This field, which is a unique address given to each signaling DPC in the network, consists of subfield NETTYPE and refinements that depend on the NETTYPE entry value. The refinements define the point code of the destination office to which the routeset establishes signaling paths.</p> <p>Point codes within the same network must be unique.</p> <p>The DPC of the routeset must differ from the point code of the network to which the routeset belongs. This point code is found by comparing the network name of the routeset found in field NETNAME in table C7RTESET with the same network name in field NETNAME in table C7NETWRK.</p>
	NETTYPE	ANSI7, CCITT7, NTC7, JPN7, or TTC7	<p><i>Network type</i></p> <p>The entry value for this field determines the DPC format variant. Most switches have only one network type defined. Gateway switches that interface between two or more network types have more than one type defined.</p> <p>If the network type is the North American variant, enter ANSI7 and datafill subfield PC.</p> <p>If the network type is the international variant, enter CCITT7 and datafill subfield FORMAT and its refinements.</p> <p>If the network type is NTC7 variant, enter NTC7 and datafill subfield PC.</p> <p>If the network type is Japan Public Network 7, enter JPN7 and datafill subfield PC.</p> <p>If the network type is Telecommunication Technology Committee 7 (used in Japan for New Common Carriers [NCC]), enter TTC7 and datafill subfields MAINAREA, SUBAREA, and AREAUNIT described later in this table.</p>

C7RTESET (continued)**NETTYPE = ANSI7**

If the entry in field NETTYPE is ANSI7, then subfield PC is datafilled.

Field descriptions for conditional datafill

Field	Subfield or refinement	Entry	Explanation and action
	PC	numeric (vector of up to three 0 to 255 entry values)	<p><i>Point code</i></p> <p>Field PC is a vector of up to three values that make up the point code for the destination. This vector must be unique within the specified network.</p> <p>Note: This field is different from the PC field that applies to CCITT7 networks with a CCITT format of BASIC.</p> <p>For ANSI7 networks, the vector consists of the following values:</p> <ul style="list-style-type: none"> • The first value is the network identifier number that is assigned to the office and the specified network. • The second value is the number of the cluster in the network identifier that is assigned to the office and the specified network. • The third value is the number of the member in the cluster that is assigned to the office and the specified network. <p>Enter one, two, or three values to specify the PC vector. If the field contains one or two values, the vector must be terminated by a \$. If the field contains three values (a full point code combination), a \$ is not needed to end the vector. Each entry must be separated from the next by a blank space.</p>

C7RTESET (continued)**NETTYPE = CCITT7**

If the entry in field NETTYPE is CCITT7, then the subfields FORMAT, ZONE, AREANETW, REGION, EXCHANGE, NUMAREA, HVST, KVST, SIGPOINT, and PC are datafilled.

Field descriptions for conditional datafill (Sheet 1 of 3)

Field	Subfield or refinement	Entry	Explanation and action
	FORMAT	AUSTRIA, BASIC, CHINA, INTL, or GERMANY	<p><i>CCITT format</i></p> <p>This field specifies the CCITT7 point code refinements for the network.</p> <p>If the point code used is for Austria, enter AUSTRIA and datafill subfields ZONE, REGION, and SIGPOINT.</p> <p>If the point code used is based on one field, enter BASIC and datafill subfield PC.</p> <p>If the point code used is for China, enter CHINA and datafill subfields ZONE, EXCHANGE, and SIGPOINT.</p> <p>If the point code used is international, enter INTL and datafill subfields ZONE, AREANETW, and SIGPOINT.</p> <p>If the point code used is for Germany, enter GERMANY and datafill subfields NUMAREA, HVST, KVST and SIGPOINT.</p>
	ZONE	0 to 31	<p><i>Zone identifier</i></p> <p>This field specifies the zone identifier that is assigned to the destination office and the specified network.</p> <p>If the entry field FORMAT is AUSTRIA, enter a number in the range 0 to 31.</p> <p>If the entry in field FORMAT is CHINA, enter a number in the range 0 to 15.</p> <p>If the entry in field FORMAT is INTL, enter a number in the range 0 to 7.</p>
	AREANETW	0 to 255	<p><i>Area/network identifier</i></p> <p>If the entry in field FORMAT is INTL, enter the number of the area/network identifier in the zone that is assigned to the destination office for the specified network.</p>

C7RTESET (continued)**Field descriptions for conditional datafill (Sheet 2 of 3)**

Field	Subfield or refinement	Entry	Explanation and action
	REGION	0 to 15	<i>Region identifier</i> If the entry in field FORMAT is AUSTRIA, enter the number of the region identifier in the zone that is assigned to the destination office for the specified network.
	EXCHANGE	0 to 127	<i>Exchange</i> If the entry in field FORMAT is CHINA, enter the number of the exchange in the zone that is assigned to the destination office for the specified network.
	NUMAREA	00 to 15	<i>Numbering Area</i> If the entry in field FORMAT is GERMANY, enter the area number assigned to the office.
	HVST	0 to 7	<i>HVSt</i> If the entry in field FORMAT is GERMANY, enter the HVSt area assigned to the office.
	KVST	00 to 15	<i>KVSt</i> If the entry in field FORMAT is GERMANY, enter the KVSt area assigned to the office.

C7RTESET (continued)**Field descriptions for conditional datafill (Sheet 3 of 3)**

Field	Subfield or refinement	Entry	Explanation and action
	SIGPOINT	0 to 31	<p><i>Signal point identifier</i></p> <p>If the entry in field FORMAT is INTL, enter a numeric value between 0 and 7 for the signal point in the area/network that is assigned to the destination office for the specified network.</p> <p>If the entry in field FORMAT is AUSTRIA, enter a numeric value between 0 and 31 for the signal point in the region that is assigned to the destination office for the specified network.</p> <p>If the entry in field FORMAT is CHINA, enter a numeric value between 0 and 7 for the signal point in the exchange that is assigned to the destination office for the specified network.</p> <p>If the entry in field FORMAT is GERMANY, enter a numeric value between 0 and 7 specifying the signal point code of the exchange.</p>
	PC	0 to 16383	<p><i>Point code</i></p> <p>If the entry in field FORMAT is BASIC, enter the DPC number for a basic CCITT7 network.</p>

C7RTESET (continued)**NETTYPE = NTC7 or JPN7**

If the entry in field NETTYPE is NTC7 or JPN7, then subfield PC is datafilled.

Field descriptions for conditional datafill

Field	Subfield or refinement	Entry	Explanation and action
	PC	numeric (vector of up to three 0-to-255 entry values)	<p><i>Point code</i></p> <p>Field PC is a vector of up to three values that make up the point code for the destination. This vector must be unique within the specified network.</p> <p>Note: This field is different from the PC field that applies to CCITT7 networks with a CCITT format of BASIC.</p> <p>The vector consists of the following values:</p> <ul style="list-style-type: none"> • The first value corresponds to the main area that is assigned to the office and the specified network. • The second value corresponds to the subarea in the main area that is assigned to the office and the specified network. • The third value corresponds to the area unit in the subarea that is assigned to the office and the specified network. <p>Enter one, two, or three values to specify the PC vector. If the field contains one or two values, the vector must be terminated by a \$. If the field contains three values (a full point code combination), a \$ is not needed to end the vector. Each entry must be separated from the next by a blank space.</p>

C7RTESET (continued)**NETTYPE = TTC7**

If the entry in field NETTYPE is TTC7, then subfields MAINAREA, SUBAREA, and AREAUNIT are datafilled.

Field descriptions for conditional datafill

Field	Subfield or refinement	Entry	Explanation and action
	MAINAREA	0 to 31	<i>Main area</i> Enter the number of the main area that is assigned to the destination office and the specified network.
	SUBAREA	0 to 15	<i>Subarea</i> Enter the number of the subarea in the main area that is assigned to the destination office and the specified network.
	AREAUNIT	0 to 127	<i>Area unit</i> Enter the number of the area unit in the subarea that is assigned to the destination office and the specified network.

For all NETTYPE values

For all subfield NETTYPE values, datafill the following additional field and subfields.

Field descriptions (Sheet 1 of 2)

Field	Subfield or refinement	Entry	Explanation and action
ROUTES		see subfields (vector of up to 6 elements)	<i>Signaling routes</i> This field consists of subfields LINKSET and COST. For JPN7 networks, a maximum of two routes can be datafilled.

C7RTESET (continued)**Field descriptions (Sheet 2 of 2)**

Field	Subfield or refinement	Entry	Explanation and action
	LINKSET	alphanumeric (1 to 16 characters)	<i>Linkset name</i> Enter the linkset name, previously defined in table C7LKSET, that makes up part of the ROUTESET. If Signaling Engineering and Administration System (SEAS) is present, the linkset name must be 8 characters.
	COST	0 to 99	<i>Cost</i> Enter the relative cost of using this route. Each route must have a cost equal to or greater than the cost of the route defined before it. This also defines the priority of the routes in the routeset. JPN7 networks do not support combined linksets. For JPN7 networks, the COST entry value must be 0 (zero).

Datafill example

The following example shows sample datafill for table C7RTESET.

This example has the following requirements:

- Two routesets are used: C7RTESET1 and C7RTESET2.
- The network name used by routeset C7RTESET1 is C7NETWRK1.
- The network name used by routeset C7RTESET2 is C7NETWRK2.
- Both routesets have a network type of ANSI7.
- The DPC for C7RTESET1 contains network value of 4.
- The DPC for C7RTESET2 contains network and cluster values of 1 and 2.
- The route for C7RTESET1 is associated with linkset C7LKSET1.
- The route for C7RTESET2 is associated with linkset C7LKSET2.

C7RTESET (continued)**MAP display example for table C7RTESET**

ROUTESET	NETNAME	TFPBCAST	DPC ROUTES
C7RTESET1	C7NETWRK1	N ANSI7 (4) \$ (C7LKSET1 4)\$	
C7RTESET2	C7NETWRK2	N ANSI7 (1) (2)\$ (C7LKSET2 5)\$	

MAP display example for table C7RTESET when USP_ACTIVE_IN_NETWORK is set to Y.

ROUTESET	NETNAME	TFPBCAST	DPC ROUTES
TEST_RTE	NEW_TESTNET	N ANSI7 (1) (2) (3)\$	

Table history**MSH14**

Message added to direct the user to the GUI on the USP for access to table data when office parameter USP_ACTIVE_IN_NETWORK is set to Y.

CSP14

Error message added for ITU and NTC7 networks. The message appears when you try to add an equal cost route and one of the linksets in the combined linkset has more than eight A, E, or F links.

CSP10

Table C7RTESET updated to include error messages. These messages appear when adding or removing the highest cost route in a routeset if the routeset is not offline.

TL08

Table C7RTESET updated to allow a maximum of 2047 routesets on an MNA7 DMS INode when external routing is enabled.

C7RTESET (continued)

TL06

Table C7RTESET updated to allow a maximum of 511 routesets on an STP/SSP INode when external routing is enabled.

Supplementary information

This section provides information on datafilling table C7RTESET for specific applications, and product descriptive information that is related to table C7RTESET.

Error messages

The following error message appears if operating company personnel attempt to add or remove the highest cost linkset that is not offline.

Attempt to add/delete the highest cost route. LINKSET must be offline.

The following error message appears if operating company personnel attempt to add or remove a linkset that is not the highest cost route in the specified routeset.

Linkset is not the highest cost route. ROUTESET must be offline.

The following error message appears if operating company personnel attempt to add or remove a linkset that is a part of a combined linkset.

Linkset is part of a combined linkset. ROUTESET must be offline.

The following error message appears if operating company personnel attempt to delete the only route in a routeset.

ROUTESET must have at least one LINKSET.

The following error message appears if operating company personnel try to add a linkset that is a part of a combined linkset (equal cost route) and either of the linksets has more than eight A, E, or F links.

Combined linkset not allowed. Linkset <linkset_name> exceeds link limit of 8.

Note: This error message applies to ITU and NTC7 networks.

C7RTESET (continued)

STP route management functions

The STP route management functions differ from signaling point (SP) route management functions in the following ways:

- STPs send TFP (transfer prohibited) messages.
- STPs send TFA (transfer allowed) messages.
- STPs send TFR (transfer restricted) messages.
- STPs send TCP (transfer cluster prohibited) messages.
- STPs send TCA (transfer cluster allowed) messages.
- STPs send TCR (transfer cluster restricted) messages.
- STPs send TFC (transfer controlled) messages.
- STPs must handle all signaling routeset test messages.

Transfer messages

Transfer messages are sent from an STP when the STP determines that routing to a destination has been affected by an event in the network. Service switching points (SSP) and service control points (SCP) do not generate these messages because they do not transfer messages through the network.

Some examples of events and the possible messages sent are as follows:

Linkset failure:

- TFP (Transfer Prohibited) or TCP is sent to indicate current STP is unavailable to route messages.
- TFR (Transfer Restricted) or TCR is sent to indicate messages are being routed via an alternate STP.

Linkset restored:

- TFA (Transfer Allowed) or TCA is sent to indicate a message route is restored and available.
- Nothing is sent if the route is an alternate.

Link restored:

- TFA or TCA is sent to indicate a link is restored and available.
- Nothing is sent if the link is an alternate.

C7RTESET (end)

TFP received:

- TFR or TCR is sent to confirm STP is unavailable to route messages.
- TFP or TCP is sent to confirm that messages are being routed via an alternate STP.

Field TFPBCAST, which only applies to an STP, determines if a TFP or TCP message is broadcast to all adjacent signaling points. If the field is set to Y, then a TFP or TCP message is broadcast. If it is set to N, message is not broadcast.

For non-STP switching units, the recommended entry value is N (however, it should be noted that Y is also a valid entry value since this field is not used within routeset management).

C7TIMER

Table name

Common Channel Signaling 7 Timer Table

Functional description

Table C7TIMER contains the timers for message transfer part (MTP) levels two and three. The table is divided into four sets or groups of tuples: Q703, Q704, Q707, and the signaling ATM adaptation layer (SAAL) level for high-speed links (HSL). Each tuple in a set is accessed by its index.

Datafill for table C7TIMER includes the following items:

- datafill of all Q704 timers for each linkset
- datafill of Q707 timers for each link
- datafill of SAAL timers for each SAAL link
- datafill of Q703 timers for each MTP2 link

The following figure illustrates the dependencies between tables C7LKSET, C7LINK, and C7TIMER.

C7TIMER (continued)

Timer table control dependencies

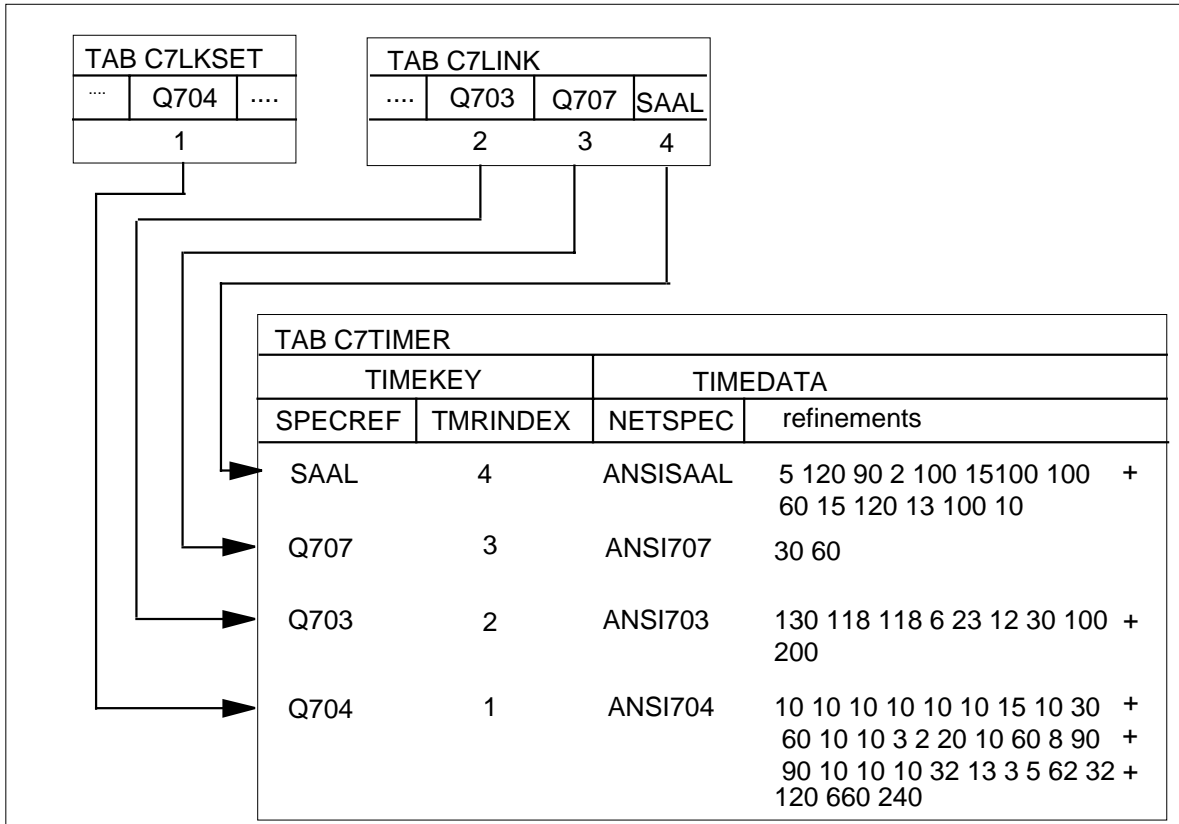

The following is a brief explanation of the figure above:

- Field SPECREF indicates the set of specification reference timers that is accessed. The four sets of reference timers are Q703, Q704, Q707 and SAAL.
- Field TMRINDEX points to a particular entry in a SPECREF set.
- Field NETSPEC indicates the network type and the timer values used.

Adding, modifying, and deleting entries in table C7TIMER

Table C7TIMER is not write protected. Operating companies can change timer values in this table to suit their needs. Consult Nortel's engineering

C7TIMER (continued)

office for information concerning these timer values and how they can be modified.

**CAUTION****Possible system disruptions and system failure**

Changing table C7TIMER timers from the recommended values to other values can cause system disruptions and possible system failure. Caution must be used when changing these timer values from the defaults.

Adding a set of timers

Fields SPECREF and TMRINDEX are used to add timers to table C7TIMER. Field SPECREF identifies the timer specification set to be accessed and field TMRINDEX uniquely identifies the entries within the given SPECREF. Range checking ensures that the timer value does not go outside the timer limits specified for the network type. An entry must exist in table C7TIMER before it can be referenced by field Q704 in table C7LKSET and fields Q703, Q707, and SAAL_INDEX in table C7LINK.

Modifying a timer table entry that is not in use

If an entry in table C7TIMER is not referenced by any entry in tables C7LINK or C7LKSET, it is not in use. Any entry in table C7TIMER that is not in use can be modified.

Deleting a timer table entry that is not in use

Any entry in table C7TIMER that is not in use can be deleted.

Modifying a timer table entry that is in use

The following rules apply for modification of a timer table entry that is in use:

- All table C7LINK links that reference a Q703, Q707 or SAAL table entry must be offline for the entry to be modified. The links obtain the new timer values when they are activated.
- All table C7LKSET linksets that reference a Q704 table entry must be offline for the entry to be modified except for MTP Restart timers (T22 to T30) which can be changed when the linksets are in service. The values (except for the MTP Restart timers T22 to T30) are sent to all peripheral modules connected to links in the affected linkset, and the stored values are updated.

C7TIMER (continued)

Deleting a timer table entry that is in use

The following rules apply for deletion of a timer table entry that is in use:

- Prior to deleting a Q703, Q707, or SAAL table entry, all links in table C7LINK that reference the entry must be taken offline and changed to reference a different tuple in table C7TIMER. When no table C7LINK entries reference the tuple in table C7TIMER, it can be deleted.
- Prior to deleting a Q704 table entry, all linksets in table C7LKSET that reference a Q704 table entry must be taken offline and changed to reference a different table C7TIMER tuple. When no table C7LKSET entries reference the tuple in table C7TIMER, it can be safely deleted.

Modifying a large number of timers

The value of a timer cannot be changed unless all links that reference the timer tuple are offline. If a large number of timers need to be changed, taking the links offline results in an unacceptable service interruption.

The preferred approach is to add a new timer tuple, then change the links or linksets one-by-one to use the new tuple. Then only one link or linkset is temporarily out of service.

Datafill sequence and implications

There is no requirement to datafill other tables before table C7TIMER.

The following tables must be datafilled after table C7TIMER:

- C7LINK
- C7LKSET
- C7NETWRK

A table C7TIMER tuple for the Q703, Q704, and Q707 set types must exist before the entries in fields Q703 and Q707 of table C7LINK and field Q704 of table C7LKSET can reference it.

Table size

0 to 96 tuples

The maximum SPECREF set size is 32 tuples for each SPECREF. The minimum table size with no active links is 0 tuples. The minimum table size with at least one active link is 3 tuples. If only high-speed links (HSL) are present, only 1 SAAL tuple is required. The minimum SPECREF set size with at least one active link is 1 tuple.

C7TIMER (continued)**Datafill**

The following table lists datafill for table C7TIMER.

Field descriptions (Sheet 1 of 4)

Field	Subfield or refinement	Entry	Explanation and action
TIMEKEY		see subfields	<i>Timer key</i> This field, which is the key to table C7TIMER, consists of subfields SPECREF and TMRINDEX.
	SPECREF	Q703, Q704, Q707 or SAAL	<i>Specification reference</i> Enter Q703, Q704, Q707, or SAAL to specify the set of specification reference timers.
	TMRINDEX	0 to 31	<i>Timer index</i> Enter a number to specify a C7TIMER index value that can be referenced by tables C7LKSET and C7LINK.
TIMEDATA		see subfields	<i>Timer data</i> This field consists of subfield NETSPEC and refinements.

C7TIMER (continued)

Field descriptions (Sheet 2 of 4)

Field	Subfield or refinement	Entry	Explanation and action
	NETSPEC	ANSI703 ANSI704 ANSI707 ANSISAAL CCITT703 CCITT704 CCITT707 NTC703 NTC704 NTC707 JPN703 JPN704 JPN707 TTC703 TTC704 TTC707	<p><i>Network type and specification reference</i></p> <p>Enter the network type and the last two digits of the specification reference.</p> <p>Note: Network type ANSISAAL does not require the last two digits of the specification reference.</p> <p>If the network is the North American variant (ANSI7) and the entry in field SPECREF is Q703, enter ANSI703 and datafill refinements described in the table of section "NETSPEC = ANSI703".</p> <p>If the network is the North American variant (ANSI7) and the entry in field SPECREF is Q704, enter ANSI704 and datafill refinements described in the table of section "NETSPEC = ANSI704".</p> <p>If the network is the North American variant (ANSI7) and the entry in field SPECREF is Q707, enter ANSI707 and datafill refinements described in the table of section "NETSPEC = ANSI707".</p> <p>If the network is the North American variant (ANSI7) and the entry in field SPECREF is SAAL, enter ANSISAAL and datafill refinements in the table of section "NETSPEC = ANSISAAL".</p> <p>If the network is CCITT7 and the entry in field SPECREF is Q703, enter CCITT703 and datafill refinements described in then table of section "NETSPEC = CCITT703".</p> <p>If the network is CCITT7 and the entry in field SPECREF is Q704, enter CCITT704 and datafill refinements described in the table of section "NETSPEC = ANSI704".</p>

C7TIMER (continued)

Field descriptions (Sheet 3 of 4)

Field	Subfield or refinement	Entry	Explanation and action
			<p>If the network is CCITT7 and the entry in field SPECREF is Q707, enter CCITT707 and datafill refinements described in the table of section "NETSPEC = CCITT707".</p> <p>If the network is NTC7 and the entry in field SPECREF is Q703, enter NTC703 and datafill refinements described in the table of section "NETSPEC = NTC703".</p> <p>If the network is NTC7 and the entry in field SPECREF is Q704, enter NTC704 and datafill refinements described in the table of section "NETSPEC = NTC704".</p> <p>If the network is NTC7 and the entry in field SPECREF is Q707, enter NTC707 and datafill refinements described in the table of section "NETSPEC = NTC707".</p> <p>If the network is the Japan Public Network variant (JPN7) and the entry in field SPECREF is Q703, enter JPN703 and datafill refinements described in the table of section "NETSPEC = JPN703".</p> <p>If the network is the Japan Public Network variant (JPN7) and the entry in field SPECREF is Q704, enter JPN704 and datafill refinements described in the table of section "NETSPEC = JPN704".</p> <p>If the network is the Japan Public Network variant (JPN7) and the entry in field SPECREF is Q707, enter JPN707 and datafill refinements described in the table of section "NETSPEC = NTC707".</p> <p>If the network is the Japanese variant (TTC7) and the entry in field SPECREF is Q703, enter TTC703 and datafill refinements described in the table of section "NETSPEC = TTC703".</p>

C7TIMER (continued)

Field descriptions (Sheet 4 of 4)

Field	Subfield or refinement	Entry	Explanation and action
			<p>If the network is the Japanese variant (TTC7) and the entry in field SPECREF is Q704, enter TTC704 and datafill refinements described in table of section "NETSPEC = TTC704".</p> <p>If the network is the Japanese variant (TTC7) and the entry in field SPECREF is Q707, enter TTC707 and datafill refinements described in the table of section "NETSPEC = TTC707".</p>

NETSPEC = ANSI703

If the entry in field NETSPEC is ANSI703, datafill refinements T1, T2, T3, T4E, T4N, T5, T6, and T7 as described in the following table.

When a new tuple is added in table C7TIMER, the default values from DEFDATA are automatically added. When the entry in field NETSPEC is changed, the default values from DEFDATA are not automatically entered.

C7TIMER (continued)

The value for each timer must be separated from the next by a single space.

Field descriptions for conditional datafill (Sheet 1 of 2)

Field	Subfield or refinement	Entry	Explanation and action
	T1	100 to 3200	<p><i>Aligned ready timer</i></p> <p>Enter the aligned ready time-out value in 100-ms units.</p> <p>The default time-out value is 130 (13 s).</p>
	T2	50 to 3000	<p><i>Not-aligned timer</i></p> <p>Enter the not-aligned time-out value in 100-ms units to define the period that the system waits for the alignment process to start at the other end of the signaling link before timing out (for example, when waiting for service information octet (SIO), normal alignment (SIN), or emergency alignment (SIE) status indications).</p> <p>Assign a different T2 value to each end of the Common Channel Signaling 7 (CCS7) signaling link to assist in the alignment process. The recommended values are 118 for one end of the linkset and 235 for the other end of the linkset.</p> <p>The default value is 118 (11.8 s).</p>
	T3	10 to 3000	<p><i>Aligned timer</i></p> <p>Enter the aligned time-out value in 100-ms units.</p> <p>The default time-out value is 118 (11.8 s).</p>
	T4E	4 to 150	<p><i>Emergency proving period timer</i></p> <p>Enter the emergency proving period time-out value in 100-ms units.</p> <p>The default time-out value is 6 (600 ms).</p>
<p>Note: The above timers are described in the appropriate sections of the relevant CCS7 signaling specifications.</p>			

C7TIMER (continued)**Field descriptions for conditional datafill (Sheet 2 of 2)**

Field	Subfield or refinement	Entry	Explanation and action
	T4N	15 to 600	<p><i>Normal proving period timer</i></p> <p>Enter the normal proving period time-out value in 100-ms units.</p> <p>The default time-out value is 23 (2.3 s).</p>
	T5	8 to 500	<p><i>Sending status indication busy timer</i></p> <p>Enter the sending status indication busy (SIB) time-out value in 10-ms units.</p> <p>The default time-out value is 20 (200 ms).</p>
	T6	20 to 750	<p><i>Remote congestion timer</i></p> <p>Enter the remote congestion time-out value in 100-ms units.</p> <p>The default time-out value is 30 (3 s).</p>
	T7	50 to 2500	<p><i>Excessive delay of acknowledgement timer</i></p> <p>Enter the excessive delay of acknowledgement time-out value in 10-ms intervals.</p> <p>The default time-out value is 100 (1 s).</p>
<p>Note: The above timers are described in the appropriate sections of the relevant CCS7 signaling specifications.</p>			

NETSPEC = CCITT703

If the entry in field NETSPEC is CCITT703, datafill refinements T1, T2, T3, T4E, T4N, T5, T6, and T7 as described in the following table.

When a new tuple is added in table C7TIMER, the default values from DEFDATA are automatically added. When the entry in field NETSPEC is changed, the default values from DEFDATA are not automatically entered.

C7TIMER (continued)

The value for each timer must be separated from the next by a single space.

Field descriptions for conditional datafill (Sheet 1 of 2)

Field	Subfield or refinement	Entry	Explanation and action
	T1	100 to 3200	<p><i>Aligned ready timer</i></p> <p>Enter the aligned ready time-out value in 100-ms units.</p> <p>The default time-out value is 400 (40 s).</p>
	T2	50 to 3000	<p><i>Not-aligned timer</i></p> <p>Enter the not-aligned time-out value in 100-ms units to define the period that the system waits for the alignment process to start at the other end of the signaling link before timing out (for example, when waiting for service information octet (SIO), normal alignment (SIN), or emergency alignment (SIE) status indications).</p> <p>Assign a different T2 value to each end of the Common Channel Signaling 7 (CCS7) signaling link to assist in the alignment process. The recommended values are 50 (5 s) for one end of the linkset and 99 (9.9 s) for the other end of the linkset.</p> <p>The default value is 50 (5 s).</p>
	T3	10 to 3000	<p><i>Aligned timer</i></p> <p>Enter the aligned time-out value in 100-ms units.</p> <p>The default time-out value is 15 (1.5 s).</p>
	T4E	4 to 150	<p><i>Emergency proving period timer</i></p> <p>Enter the emergency proving period time-out value in 100-ms units.</p> <p>The default time-out value is 5 (500 ms).</p>
<p>Note: The above timers are described in the appropriate sections of the relevant CCS7 signaling specifications.</p>			

C7TIMER (continued)**Field descriptions for conditional datafill (Sheet 2 of 2)**

Field	Subfield or refinement	Entry	Explanation and action
	T4N	15 to 600	<p><i>Normal proving period timer</i></p> <p>Enter the normal proving period time-out value in 100-ms units.</p> <p>The default time-out value is 82 (8.2 s).</p>
	T5	8 to 500	<p><i>Sending status indication busy timer</i></p> <p>Enter the sending status indication busy (SIB) time-out value in 10-ms units.</p> <p>The default time-out value is 20 (200 ms).</p>
	T6	20 to 750	<p><i>Remote congestion timer</i></p> <p>Enter the remote congestion time-out value in 100-ms units.</p> <p>The default time-out value is 30 (3 s).</p>
	T7	50 to 2500	<p><i>Excessive delay of acknowledgement timer</i></p> <p>Enter the excessive delay of acknowledgement time-out value in 10-ms intervals.</p> <p>The default time-out value is 100 (1 s).</p>
<p>Note: The above timers are described in the appropriate sections of the relevant CCS7 signaling specifications.</p>			

NETSPEC = NTC703

If the entry in field NETSPEC is NTC703, datafill refinements T1, T2, T3, T4E, T4N, T5, T6, and T7 as described in the following table.

When a new entry is added in field NETSPEC, the default values from DEFDATA are automatically added. When the entry in field NETSPEC is changed, the default values from DEFDATA are not automatically entered.

C7TIMER (continued)

The value for each timer must be separated from the next by a single space.

Field descriptions for conditional datafill (Sheet 1 of 2)

Field	Subfield or refinement	Entry	Explanation and action
	T1	400 to 500	<p><i>Aligned ready timer</i></p> <p>Enter the aligned ready time-out value in 100-ms units.</p> <p>The default time-out value is 450 (45 s).</p>
	T2	50 to 1500	<p><i>Not-aligned timer</i></p> <p>Enter the not-aligned time-out value in 100-ms units to define the period that the system waits for the alignment process to start at the other end of the signaling link before timing out (for example, when waiting for service information octet (SIO), normal alignment (SIN), or emergency alignment (SIE) status indications).</p> <p>Assign a different T2 value to each end of the Common Channel Signaling 7 (CCS7) signaling link to assist in the alignment process.</p> <p>The default time-out value is 1320 (132 s).</p>
	T3	10 to 15	<p><i>Aligned timer</i></p> <p>Enter the aligned time-out value in 100-ms units.</p> <p>The default time-out value is 10 (1 s).</p>
	T4E	4 to 6	<p><i>Emergency proving period timer</i></p> <p>Enter the emergency proving period time-out value in 100-ms units.</p> <p>The default time-out value is 5 (500 ms).</p>
	T4N	75 to 95	<p><i>Normal proving period timer</i></p> <p>Enter the normal proving period time-out value in 100-ms units.</p> <p>The default time-out value is 82 (8.2 s).</p>
<p>Note: The above timers are described in the appropriate sections of the relevant CCS7 signaling specifications.</p>			

C7TIMER (continued)

Field descriptions for conditional datafill (Sheet 2 of 2)

Field	Subfield or refinement	Entry	Explanation and action
	T5	8 to 12	<p><i>Sending status indication busy timer</i></p> <p>Enter the sending status indication busy (SIB) time-out value in 10-ms units.</p> <p>The default time-out value is 10 (100 ms).</p>
	T6	30 to 60	<p><i>Remote congestion timer</i></p> <p>Enter the remote congestion time-out value in 100-ms units.</p> <p>The default time-out value is 50 (5 s).</p>
	T7	50 to 200	<p><i>Excessive delay of acknowledgement timer</i></p> <p>Enter the excessive delay of acknowledgement time-out value in 10-ms intervals.</p> <p>The default time-out value is 200 (2 s).</p>
<p>Note: The above timers are described in the appropriate sections of the relevant CCS7 signaling specifications.</p>			

NETSPEC = JPN703

If the entry in field NETSPEC is JPN703, datafill refinements T1, T2, T3, T4E, T5, T6, T7, and TF as described in the following table.

When a new entry is added in field NETSPEC, the default values from DEFDATA are automatically added. When the entry in field NETSPEC is changed, the default values from DEFDATA are not automatically entered.

C7TIMER (continued)

The value for each timer must be separated from the next by a single space.

Field descriptions for conditional datafill (Sheet 1 of 2)

Field	Subfield or refinement	Entry	Explanation and action
	T1	10 to 300	<p><i>Aligned ready timer</i></p> <p>Enter the aligned ready time-out value in 100-ms units.</p> <p>The default time-out value is 30 (3 s).</p>
	T2	50 to 4800	<p><i>Not-aligned timer</i></p> <p>Enter the not-aligned time-out value in 100-ms units to define the period that the system will wait for the alignment process to start at the other end of the signaling link before timing out (for example, when waiting for service information octet (SIO), normal alignment (SIN), or emergency alignment (SIE) status indications).</p> <p>Assign a different T2 value to each end of the CCS7 signaling link to assist in the alignment process.</p> <p>The default time-out value is 4800 (480 s).</p>
	T3	50 to 4800	<p><i>Aligned timer</i></p> <p>Enter the aligned time-out in 100-ms units.</p> <p>The default time-out value is 4800 (480 s).</p>
	T4E	4 to 30	<p><i>Emergency proving period timer</i></p> <p>Enter the emergency proving period time-out value in 100-ms units.</p> <p>The default time-out value is 30 (3 s).</p>
	T5	10 to 150	<p><i>Sending status indication busy timer</i></p> <p>Enter the sending status indication busy (SIB) time-out value in 10-ms units.</p> <p>The default time-out value is 20 (200 ms).</p>
<p>Note: The above timers are described in the appropriate sections of the relevant CCS7 signaling specifications.</p>			

C7TIMER (continued)

Field descriptions for conditional datafill (Sheet 2 of 2)

Field	Subfield or refinement	Entry	Explanation and action
	T6	30 to 200	<p><i>Remote congestion timer</i></p> <p>Enter the remote congestion time-out value in 100-ms units.</p> <p>The default time-out value is 200 (20 s).</p>
	T7	50 to 300	<p><i>Excessive delay of acknowledgement timer</i></p> <p>Enter the excessive delay of acknowledgement time-out value in 10-ms intervals.</p> <p>The default time-out value is 200 (2 s).</p>
	TF	1 to 252	<p><i>Flag count</i></p> <p>Enter the flag count value to specify the rate at which repeated link status signal units (LSSU) or fill-in signal units (FISU) are transmitted by the local signaling terminal (ST). This value indicates the number of flags.</p> <p>The default value is 137 (137 flags).</p> <p>Note: The flag count value is specific to the JPN7 network.</p>
<p>Note: The above timers are described in the appropriate sections of the relevant CCS7 signaling specifications.</p>			

NETSPEC = TTC703

If the entry in field NETSPEC is TTC703, datafill refinements T1, T2, T3, T4E, T5, T6, and T7 as described in the following table.

When a new entry is added in field NETSPEC, the default values from DEFDATA are automatically added. When the entry in field NETSPEC is changed, the default values from DEFDATA are not automatically entered.

C7TIMER (continued)

The value for each timer must be separated from the next by a single space.

Field descriptions for conditional datafill (Sheet 1 of 2)

Field	Subfield or refinement	Entry	Explanation and action
	T1	100 to 3200	<p><i>Aligned ready timer</i></p> <p>Enter the aligned ready time-out value in 100-ms units.</p> <p>The default time-out value is 130 (13 s).</p>
	T2	50 to 4800	<p><i>Not-aligned timer</i></p> <p>Enter the not-aligned time-out value in 100-ms units to define the time period that the system waits for the alignment process to start at the other end of the signaling link before timing out (for example, when waiting for service information octet (SIO), normal alignment (SIN), or emergency alignment (SIE) status indications).</p> <p>Enter a T2 different value at each end of the CCS7 signaling link to assist in the alignment process. The recommended values are 118 for one end of the linkset and 235 for the other end of the linkset.</p> <p>The default time-out value is 4800 (480 s).</p>
	T3	10 to 4800	<p><i>Aligned timer</i></p> <p>Enter the aligned time-out value in 100-ms units.</p> <p>The default time-out value is 4800 (480 s).</p>
	T4E	4 to 30	<p><i>Emergency proving period timer</i></p> <p>Enter the emergency proving period time-out value in 100-ms units.</p> <p>The default time-out value is 30 (3 s).</p>
<p>Note: The above timers are described in the appropriate sections of the relevant CCS7 signaling specifications.</p>			

C7TIMER (continued)

Field descriptions for conditional datafill (Sheet 2 of 2)

Field	Subfield or refinement	Entry	Explanation and action
	T5	8 to 500	<p><i>Sending status indication busy timer</i></p> <p>Enter the sending status indication busy (SIB) time-out value in 10-ms units.</p> <p>The default time-out value is 20 (200 ms).</p>
	T6	30 to 200	<p><i>Remote congestion timer</i></p> <p>Enter the remote congestion time-out value in 100-ms intervals.</p> <p>The default time-out value is 200 (20 s).</p>
	T7	50 to 300	<p><i>Excessive delay of acknowledgement timer</i></p> <p>Enter the excessive delay of acknowledgement time-out value in 10-ms units.</p> <p>The default time-out value is 200 (2 s).</p>
<p>Note: The above timers are described in the appropriate sections of the relevant CCS7 signaling specifications.</p>			

NETSPEC = ANSI704

If the entry in field NETSPEC is ANSI704, datafill refinements T1, T2, T3, T4, T5, T6, T7, T8, T10, T11, T12, T13, T14, T15, T16, T17, T18, T19, T20, T21, T22, T23, T24, T25, T26, T27, T28, T29, T30, T31, T33, and T34 as described in the following table.

When a new entry is added in field NETSPEC, the default values from DEFDATA are automatically added. When the entry in field NETSPEC is changed, the default values from DEFDATA are not automatically entered.

C7TIMER (continued)

The value for each timer must be separated from the next by a single space.

**CAUTION****Nodal timers are automatically changed for all ANSI704 networks**

Timers T22, T23, T24, and T26 are nodal. Each nodal timer is to be datafilled the same in all ANSI704 networks. When one of these nodal timers is changed in one ANSI704 network, the following warning message is issued indicating it has been changed for all ANSI704 networks.

```
***WARNING***
```

```
Nodal timers must be the same in all tuples for
a network
All other tuples for this network type will be
modified
```

Field descriptions for conditional datafill (Sheet 1 of 7)

Field	Subfield or refinement	Entry	Explanation and action
	T1	5 to 250	<p><i>Mis-sequence changeover timer</i></p> <p>Enter the mis-sequence changeover time-out value in 100-ms units.</p> <p>The default time-out value is 10 (1 s).</p>
	T2	5 to 250	<p><i>Changeover acknowledgement timer</i></p> <p>Enter the changeover acknowledgement time-out value in 100-ms units.</p> <p>The default time-out value is 10 (1 s).</p>
	T3	5 to 250	<p><i>Mis-sequence changeback timer</i></p> <p>Enter the mis-sequence changeback time-out value in 100-ms units.</p> <p>The default time-out value is 10 (1 s).</p>

Note: The above timers are described in the appropriate sections of the relevant CCS7 signaling specifications.

C7TIMER (continued)**Field descriptions for conditional datafill (Sheet 2 of 7)**

Field	Subfield or refinement	Entry	Explanation and action
	T4	5 to 250	<p><i>Changeback acknowledgement timer (first attempt)</i></p> <p>Enter the changeback acknowledgement time-out value (first attempt) in 100-ms units.</p> <p>The default time-out value is 10 (1 s).</p>
	T5	5 to 250	<p><i>Changeback acknowledgement timer (second attempt)</i></p> <p>Enter the changeback acknowledgement time-out value (second attempt) in 100-ms units.</p> <p>The default time-out value is 10 (1 s).</p>
	T6	5 to 250	<p><i>Controlled rerouting timer</i></p> <p>Enter the controlled rerouting time-out value in 100-ms units.</p> <p>The default time-out value is 10 (1 s).</p>
	T7	10 to 400	<p><i>Signaling data link connection acknowledgement timer</i></p> <p>Enter the signaling data link connection acknowledgement time-out value in 100-ms units.</p> <p>The default time-out value is 15 (1.5 s).</p>
	T8	5 to 250	<p><i>Transfer prohibited timer</i></p> <p>Enter the transfer prohibited time-out value in 100-ms units.</p> <p>The default time-out value is 10 (1 s).</p>
<p>Note: The above timers are described in the appropriate sections of the relevant CCS7 signaling specifications.</p>			

C7TIMER (continued)**Field descriptions for conditional datafill (Sheet 3 of 7)**

Field	Subfield or refinement	Entry	Explanation and action
	T10	20 to 750	<p><i>Signaling routeset test message timer</i></p> <p>Enter the signaling routeset test message time-out value in 1-s units.</p> <p>The default time-out value is 30 (30 s).</p> <p>Note: The default time-out value must be increased to 60 (60 s) if more than 511 routesets are enabled with software optionality control (SOC).</p>
	T11	30 to 1700	<p><i>Transfer restricted timer</i></p> <p>Enter the transfer restricted time-out value in 1-s units.</p> <p>The default time-out value is 90 s.</p>
	T12	5 to 250	<p><i>Uninhibit acknowledgement timer</i></p> <p>Enter the uninhibit acknowledge time-out value in 100-ms units.</p> <p>The default time-out value is 10 (1 s).</p>
	T13	5 to 250	<p><i>Forced uninhibit timer</i></p> <p>Enter the forced uninhibit time-out value in 100-ms units.</p> <p>The default time-out value is 10 (1 s).</p>
	T14	2 to 80	<p><i>Inhibit acknowledgement message timer</i></p> <p>Enter the inhibit acknowledgement message time-out value in 1-s units.</p> <p>The default value is 3 (3 s).</p>
	T15	1 to 60	<p><i>Repeat routeset congestion test timer</i></p> <p>Enter the repeat routeset congestion test time-out value in 1-s units.</p> <p>The default time-out value is 2 (2 s).</p>
<p>Note: The above timers are described in the appropriate sections of the relevant CCS7 signaling specifications.</p>			

C7TIMER (continued)**Field descriptions for conditional datafill (Sheet 4 of 7)**

Field	Subfield or refinement	Entry	Explanation and action
	T16	5 to 500	<p><i>Routeset congestion status update timer</i></p> <p>Enter the routeset congestion status update time-out value in 100-ms units.</p> <p>The default time-out value is 20 (2 s).</p>
	T17	5 to 250	<p><i>Initial alignment failure and link restart timer</i></p> <p>Enter the initial alignment failure and link restart time-out value in 100-ms units.</p> <p>The default time-out value is 10 (1 s).</p>
	T18	30 to 1500	<p><i>Transfer cluster restricted timer</i></p> <p>Enter the transfer cluster restricted time-out value in 1-s units.</p> <p>The default value is 60 (60 s).</p>
	T19	7 to 200	<p><i>Failed link craft referral timer</i></p> <p>Enter the failed link craft referral time-out value in 1-min units.</p> <p>The default value is 8 (8 min).</p>
	T20	70 to 2200	<p><i>Local inhibit test timer</i></p> <p>Enter the local inhibit test time-out value in 1-s units.</p> <p>The default value is 90 (90 s).</p>
	T21	70 to 2200	<p><i>Remote inhibit test timer</i></p> <p>Enter the remote inhibit test time-out value in 1-s units.</p> <p>The default value is 90 (90 s).</p>
	T22	1 to 60	<p><i>Signaling link available timer</i></p> <p>Enter the waiting for signaling links available at restarting node time-out value in 1-s units. One timer entered for the node.</p> <p>The default value is 40 (40 s).</p>

Note: The above timers are described in the appropriate sections of the relevant CCS7 signaling specifications.

C7TIMER (continued)**Field descriptions for conditional datafill (Sheet 5 of 7)**

Field	Subfield or refinement	Entry	Explanation and action
	T23	1 to 60	<p><i>Receiving TRA messages timer</i></p> <p>Enter the receiving TRA (traffic restart allowed) messages time-out value in 1-s units. One timer entered for the node.</p> <p>The default value is 10 (10 s).</p>
	T24	1 to 60	<p><i>Broadcasting status messages timer</i></p> <p>Enter the broadcasting status time-out value in 1-s units. One timer entered for the node.</p> <p>The default value is 10 (10 s).</p>
	T25	1 to 60	<p><i>Adjacent node waiting for TRA message timer</i></p> <p>Enter the adjacent node to restart node waiting for TRA (traffic restart allowed) message time-out value in 1-s units. One timer entered per linkset.</p> <p>The default value is 32 (32 s).</p>
	T26	5 to 20	<p><i>Waiting to repeat TRW message timer</i></p> <p>Enter the waiting to repeat TRW (traffic restart waiting) message time-out value in 1-s units. One timer entered for the node.</p> <p>The default value is 13 (13 s).</p>
	T27	2 to 5	<p><i>Minimum duration of unavailability for full restart timer</i></p> <p>Enter the minimum duration of unavailability for full restart time-out value in 1-s units. One timer entered for the node.</p> <p>The default value is 3 (3 s).</p>

Note: The above timers are described in the appropriate sections of the relevant CCS7 signaling specifications.

C7TIMER (continued)**Field descriptions for conditional datafill (Sheet 6 of 7)**

Field	Subfield or refinement	Entry	Explanation and action
	T28	1 to 60	<p><i>Adjacent node waiting for TRW message timer</i></p> <p>Enter the waiting for TRW (traffic restart waiting) message at node adjacent to restart node time-out value in 1-s units. One timer entered per linkset.</p> <p>The default value is 5 (5 s).</p>
	T29	60 to 90	<p><i>TRA message sent in response to unexpected TRA or TRW timer</i></p> <p>Enter the TRA (traffic restart allowed) message sent in response to unexpected TRA or TRW (traffic restart waiting) message time-out value in 1-s units. One timer entered per linkset.</p> <p>The default value is 62 (62 s).</p>
	T30	1 to 60	<p><i>Limit sending TFP and TFR in response to unexpected TRA or TRW timer</i></p> <p>Enter the limit sending of TFP (transfer prohibited) and TFR (transfer restricted) messages in response to unexpected TRA or TRW (traffic restart waiting) message time-out value in 1-s units. One timer entered per linkset.</p> <p>The default value is 32 (32 s).</p>
	T31	10 to 120	<p><i>Limit the time a link remains in false congestion</i></p> <p>Enter the maximum time a link will remain in false congestion before the system restarts it. Enter one timer per linkset. Enter the value in 1s units. The default value is 120 (120 s).</p>

Note: The above timers are described in the appropriate sections of the relevant CCS7 signaling specifications.

C7TIMER (continued)**Field descriptions for conditional datafill (Sheet 7 of 7)**

Field	Subfield or refinement	Entry	Explanation and action
	T33	60 to 660	<p><i>Link probation timer</i></p> <p>Enter the probation time for the link brought into service. If the link becomes system busy (SysB) before the expiration of this timer, the system starts timer T34. The link remains in SysB state until timer T34 expires.</p> <p>Enter the value in 1-s units. The default value is 660 (660 s).</p>
	T34	5 to 240	<p><i>Link penalty timer</i></p> <p>Enter the maximum time a link will remain in SysB state before the system tries to return the link to service.</p> <p>Enter the value in 1-s units. The default value is 240 (240 s).</p>
<p>Note: The above timers are described in the appropriate sections of the relevant CCS7 signaling specifications.</p>			

NETSPEC = CCITT704

If the entry in field NETSPEC is CCITT704, datafill refinements T1, T2, T3, T4, T5, T6, T7, T8, T10, T11, T12, T13, T14, T15, T16, T17, T18, T19, T20, T21, T22, T23 and T24 as described in the following table.

When a new entry is added in field NETSPEC, the default values from DEFDATA are automatically added. When the entry in field NETSPEC is changed, the default values from DEFDATA are not automatically entered.

C7TIMER (continued)

The value for each timer must be separated from the next by a single space.

**CAUTION****Nodal timers are automatically updated for all non-ANSI704 networks**

Timers T18 and T20 are nodal. Each nodal timer is to be datafilled the same in all non-ANSI704 networks. When one of these nodal timers is changed in one non-ANSI704 network, the following warning message is issued indicating it has been changed for all non-ANSI704 networks.

```
***WARNING***
```

```
Nodal timers must be the same in all tuples for
a network
All other tuples for this network type will be
modified
```

Field descriptions for conditional datafill (Sheet 1 of 5)

Field	Subfield or refinement	Entry	Explanation and action
	T1	5 to 250	<p><i>Mis-sequence changeover timer</i></p> <p>Enter the mis-sequence changeover time-out value in 100-ms units.</p> <p>The default time-out value is 10 (1 s).</p>
	T2	5 to 250	<p><i>Changeover acknowledgement timer</i></p> <p>Enter the changeover acknowledgement time-out value in 100-ms units.</p> <p>The default time-out value is 10 (1 s).</p>
	T3	5 to 250	<p><i>Mis-sequence changeback timer</i></p> <p>Enter the mis-sequence changeback time-out value in 100-ms units.</p> <p>The default time-out value is 10 (1 s).</p>
<p>Note: The above timers are described in the appropriate sections of the relevant CCS7 signaling specifications.</p>			

C7TIMER (continued)**Field descriptions for conditional datafill (Sheet 2 of 5)**

Field	Subfield or refinement	Entry	Explanation and action
	T4	5 to 250	<p><i>Changeback acknowledgement timer (first attempt)</i></p> <p>Enter the changeback acknowledgement time-out value (first attempt) in 100-ms units.</p> <p>The default time-out value is 10 (1 s).</p>
	T5	5 to 250	<p><i>Changeback acknowledgement timer (second attempt)</i></p> <p>Enter the changeback acknowledgement time-out value (second attempt) in 100-ms units.</p> <p>The default time-out value is 10 (1 s).</p>
	T6	5 to 250	<p><i>Controlled rerouting timer</i></p> <p>Enter the controlled rerouting time-out value in 100-ms units.</p> <p>The default time-out value is 10 (1 s).</p>
	T7	10 to 400	<p><i>Signaling data link connection acknowledgement timer</i></p> <p>Enter the signaling data link connection acknowledgement time-out value in 100-ms units.</p> <p>The default time-out value is 15 (1.5 s).</p>
	T8	5 to 250	<p><i>Transfer prohibited timer</i></p> <p>Enter the transfer prohibited time-out value in 100-ms units.</p> <p>The default time-out value is 10 (1 s).</p>
<p>Note: The above timers are described in the appropriate sections of the relevant CCS7 signaling specifications.</p>			

C7TIMER (continued)**Field descriptions for conditional datafill (Sheet 3 of 5)**

Field	Subfield or refinement	Entry	Explanation and action
	T10	20 to 750	<p><i>Signaling routeset test message timer</i></p> <p>Enter the signaling routeset test message time-out value in 1-s units.</p> <p>The default time-out value is 30 (30 s).</p> <p>Note: The default time-out value must be increased to 60 (60 s) if more than 511 routesets are enabled with software optionality control (SOC).</p>
	T11	30 to 1700	<p><i>Transfer restricted timer</i></p> <p>Enter the transfer restricted time-out value in 1-s units.</p> <p>The default time-out value is 90 (90 s).</p>
	T12	5 to 250	<p><i>Uninhibit acknowledgement timer</i></p> <p>Enter the uninhibit acknowledge time-out value in 100-ms units.</p> <p>The default time-out value is 10 (1 s).</p>
	T13	5 to 250	<p><i>Forced uninhibit timer</i></p> <p>Enter the forced uninhibit time-out value in 100-ms units.</p> <p>The default time-out value is 10 (1 s).</p>
	T14	2 to 80	<p><i>Inhibit acknowledgement message timer</i></p> <p>Enter the inhibit acknowledgement message time-out value in 1-s units.</p> <p>The default value is 3 (3 s).</p>
	T15	1 to 60	<p><i>Repeat routeset congestion test timer</i></p> <p>Enter the repeat routeset congestion test time-out value in 1-s units.</p> <p>The default time-out value is 2 (2 s).</p>
<p>Note: The above timers are described in the appropriate sections of the relevant CCS7 signaling specifications.</p>			

C7TIMER (continued)**Field descriptions for conditional datafill (Sheet 4 of 5)**

Field	Subfield or refinement	Entry	Explanation and action
	T16	5 to 500	<p><i>Routeset congestion status update timer</i></p> <p>Enter the routeset congestion status update time-out value in 100-ms units.</p> <p>The default time-out value is 20 (2 s).</p>
	T17	5 to 250	<p><i>Initial alignment failure and link restart time</i></p> <p>Enter the initial alignment failure and link restart time-out value in 100-ms units.</p> <p>The default time-out value is 10 (1 s).</p>
	T18	5 to 60	<p><i>MTP restart STP TRA received timer</i></p> <p>Enter the <i>MTP restart STP TRA received timer</i> value in 1-s units.</p> <p>The default value is 40 (40 s).</p>
	T19	60 to 90	<p><i>MTP restart late TRA filter timer</i></p> <p>Enter the MTP restart late TRA filter timer value in 1-s units.</p> <p>The default value is 67 (67 s).</p>
	T20	5 to 120	<p><i>MTP restart overall timer</i></p> <p>Enter the restart overall timer value in 1-s units.</p> <p>The default value is 60 (60 s).</p>
	T21	5 to 120	<p><i>MTP restart adjacent node timer</i></p> <p>Enter the MTP restart adjacent node timer value in 1-s units.</p> <p>The default value is 63 (63 s).</p>
	T22	70 to 2200	<p><i>Local inhibit test timer</i></p> <p>Enter the local inhibit test time-out value in 1-s units.</p> <p>The default value is 180 (3 min).</p>
<p>Note: The above timers are described in the appropriate sections of the relevant CCS7 signaling specifications.</p>			

C7TIMER (continued)**Field descriptions for conditional datafill (Sheet 5 of 5)**

Field	Subfield or refinement	Entry	Explanation and action
	T23	70 to 2200	<p><i>Remote inhibit test timer</i></p> <p>Enter the remote inhibit test time-out value in 1-s units.</p> <p>The default value is 180 (3 min).</p>
	T24	7 to 200	<p><i>Failed link craft referral timer</i></p> <p>Enter the failed link craft referral time-out value in 1-min units.</p> <p>The default value is 8 (8 min).</p>
<p>Note: The above timers are described in the appropriate sections of the relevant CCS7 signaling specifications.</p>			

NETSPEC = NTC704

If the entry in field NETSPEC is NTC704, datafill refinements T1, T2, T3, T4, T5, T6, T7, T8, T10, T11, T12, T13, T14, T15, T16, T17, T18, T19, T21, T22, and T23 as described in the following table.

When a new entry is added in field NETSPEC, the default values from DEFDATA are automatically added. When the entry in field NETSPEC is changed, the default values from DEFDATA are not automatically entered.

The value for each timer must be separated from the next by a single space.

**CAUTION****Nodal timers are automatically updated for all non-ANSI704 networks**

Timers T18 and T20 are nodal. Each nodal timer is to be datafilled the same in all non-ANSI704 networks. When one of these nodal timers is changed in one non-ANSI704 network, the following warning message is issued indicating it has been changed for all non-ANSI704 networks.

WARNING

Nodal timers must be the same in all tuples for a network
 All other tuples for this network type will be modified

C7TIMER (continued)**Field descriptions for conditional datafill (Sheet 1 of 4)**

Field	Subfield or refinement	Entry	Explanation and action
	T1	5 to 12	<p><i>Mis-sequence changeover timer</i></p> <p>Enter the mis-sequence changeover time-out value in 100-ms units.</p> <p>The default time-out value is 10 (1 s).</p>
	T2	7 to 20	<p><i>Changeover acknowledgement timer</i></p> <p>Enter the changeover acknowledgement time-out value in 100-ms units.</p> <p>The default time-out value is 10 (1 s).</p>
	T3	5 to 12	<p><i>Mis-sequence changeback timer</i></p> <p>Enter the mis-sequence changeback time-out value in 100-ms units.</p> <p>The default time-out value is 10 (1 s).</p>
	T4	5 to 12	<p><i>Changeback acknowledgement timer (first attempt)</i></p> <p>Enter the changeback acknowledgement time-out value (first attempt) in 100-ms units.</p> <p>The default time-out value is 10 (1 s).</p>
	T5	5 to 12	<p><i>Changeback acknowledgement timer (second attempt)</i></p> <p>Enter the changeback acknowledgement time-out value (second attempt) in 100-ms units.</p> <p>The default time-out value is 10 (1 s).</p>
	T6	5 to 12	<p><i>Controlled rerouting timer</i></p> <p>Enter the controlled rerouting time-out value in 100-ms units.</p> <p>The default time-out value is 10 (1 s).</p>
<p>Note: The above timers are described in the appropriate sections of the relevant CCS7 signaling specifications.</p>			

C7TIMER (continued)

Field descriptions for conditional datafill (Sheet 2 of 4)

Field	Subfield or refinement	Entry	Explanation and action
	T7	10 to 20	<p><i>Signaling data link connection acknowledgement timer</i></p> <p>Enter the signaling data link connection acknowledgement time-out value in 100-ms units.</p> <p>The default time-out value is 15 (1.5 s).</p>
	T8	8 to 12	<p><i>Transfer prohibited timer</i></p> <p>Enter the transfer prohibited time-out value in 100-ms units.</p> <p>The default time-out value is 10 (1 s).</p>
	T10	30 to 60	<p><i>Signaling routeset test message timer</i></p> <p>Enter the signaling routeset test message time-out value in 1-s units.</p> <p>The default time-out value is 30 (30 s).</p> <p>Note: The default time-out value must be increased to 60 (60 s) if more than 511 routesets are enabled with software optionality control (SOC).</p>
	T11	30 to 90	<p><i>Transfer restricted timer</i></p> <p>Enter the transfer restricted time-out value in 1-s units.</p> <p>The default time-out value is 69 (69 s).</p>
	T12	8 to 15	<p><i>Uninhibit acknowledgement timer</i></p> <p>Enter the uninhibit acknowledge time-out value in 100-ms units.</p> <p>The default time-out value is 10 (1 s).</p>
<p>Note: The above timers are described in the appropriate sections of the relevant CCS7 signaling specifications.</p>			

C7TIMER (continued)**Field descriptions for conditional datafill (Sheet 3 of 4)**

Field	Subfield or refinement	Entry	Explanation and action
	T13	8 to 15	<p><i>Forced uninhibit timer</i></p> <p>Enter the forced uninhibit time-out value in 100-ms units.</p> <p>The default time-out value is 10 (1 s).</p>
	T14	2 or 3	<p><i>Inhibit acknowledgement message timer</i></p> <p>Enter the inhibit acknowledgement message time-out value in 1-s units.</p> <p>The default value is 3 (3 s).</p>
	T15	2 or 3	<p><i>Repeat routeset congestion test timer</i></p> <p>Enter the repeat routeset congestion test time-out value in 1-s units.</p> <p>The default time-out value is 2 (2 s).</p>
	T16	14 to 20	<p><i>Routeset congestion status update timer</i></p> <p>Enter the routeset congestion status update time-out value in 100-ms units.</p> <p>The default time-out value is 20 (2 s).</p>
	T17	8 to 15	<p><i>Initial alignment failure and link restart timer</i></p> <p>Enter the initial alignment failure and link restart time-out value in 100-ms units.</p> <p>The default time-out value is 10 (1 s).</p>
	T18	5 to 60	<p><i>Restart STP TRA received timer</i></p> <p>Enter the STP TRA receiver timer value in 1s units.</p> <p>The default time-out value is 40 (40 s).</p>
	T19	60 to 90	<p><i>Restart Late TRA filter timer</i></p> <p>Enter the TRA filter timer value in 1s units.</p> <p>The default time-out value is 67 (67 s).</p>
<p>Note: The above timers are described in the appropriate sections of the relevant CCS7 signaling specifications.</p>			

C7TIMER (continued)

Field descriptions for conditional datafill (Sheet 4 of 4)

Field	Subfield or refinement	Entry	Explanation and action
	T20	5 to 120	<i>Restart overall timer</i> Enter the overall timer value in 1s units. The default time-out value is 59 (59 s).
	T21	5 to 120	<i>Restart adjacent node timer</i> Enter the adjacent node timer value in 1s units. The default time-out value is 63 (63 s).
	T22	180 to 360	<i>Local inhibit test timer</i> Enter the local inhibit test time-out value in 1-s units. The default value is 180 (3 min).
	T23	180 to 360	<i>Remote inhibit test timer</i> Enter the remote inhibit test time-out value in 1-s units. The default value is 180 (3 min).
Note: The above timers are described in the appropriate sections of the relevant CCS7 signaling specifications.			

NETSPEC = JPN704

If the entry in field NETSPEC is JPN704, datafill refinements T1, T2, T3, T4, T6, T10, T16, T17, T18, T19, T20 and T21 as described in the following table.

When a new entry is added in field NETSPEC, the default values from DEFDATA are automatically added. When the entry in field NETSPEC is changed, the default values from DEFDATA are not automatically entered.

C7TIMER (continued)

The value for each timer must be separated from the next by a single space.

**CAUTION****Nodal timers are automatically updated for all non-ANSI704 networks**

Timers T18 and T20 are nodal. Each nodal timer is to be datafilled the same in all non-ANSI704 networks. When one of these nodal timers is changed in one non-ANSI704 network, the following warning message is issued indicating it has been changed for all non-ANSI704 networks.

```
***WARNING***
```

```
Nodal timers must be the same in all tuples for
a network
All other tuples for this network type will be
modified
```

Field descriptions for conditional datafill (Sheet 1 of 3)

Field	Subfield or refinement	Entry	Explanation and action
	T1	5 to 250	<p><i>Mis-sequence changeover timer</i></p> <p>Enter the mis-sequence changeover time-out value in 100-ms units.</p> <p>The default time-out value is 10 (1 s).</p>
	T2	5 to 250	<p><i>Changeover acknowledgement timer</i></p> <p>Enter the changeover acknowledgement time-out value in 100-ms units.</p> <p>The default time-out value is 10 (1 s).</p>
	T3	5 to 250	<p><i>Mis-sequence changeback timer</i></p> <p>Enter the mis-sequence changeback time-out value in 100-ms units.</p> <p>The default time-out value is 10 (1 s).</p>
<p>Note: The above timers are described in the appropriate sections of the relevant CCS7 signaling specifications.</p>			

C7TIMER (continued)**Field descriptions for conditional datafill (Sheet 2 of 3)**

Field	Subfield or refinement	Entry	Explanation and action
	T4	5 to 250	<p><i>Changeback acknowledgement timer (first attempt)</i></p> <p>Enter the changeback acknowledgement time-out value (first attempt) in 100-ms units.</p> <p>The default time-out value is 10 (1 s).</p>
	T6	5 to 250	<p><i>Controlled rerouting timer</i></p> <p>Enter the controlled rerouting time-out value in 100-ms units.</p> <p>The default time-out value is 10 (1 s).</p>
	T10	20 to 750	<p><i>Signaling routeset test message timer</i></p> <p>Enter the signaling routeset test message time-out value in 1-s units.</p> <p>The default time-out value is 30 (30 s).</p> <p>Note: The default time-out value must be increased to 60 (60 s) if more than 511 routesets are enabled with software optionality control (SOC).</p>
	T16	1 to 100	<p><i>Transfer controlled congestion timer</i></p> <p>Enter the transfer controlled (TFC) and link congestion time-out value in 1-s units.</p> <p>The default time-out value is 90 (90 s).</p>
	T17	5 to 250	<p><i>Initial alignment failure and link restart timer</i></p> <p>Enter the initial alignment failure and link restart time-out value in 100-ms units.</p> <p>The default time-out value is 10 (1 s).</p>
	T18	5 to 60	<p><i>Restart STP TRA received timer</i></p> <p>Enter the STP TRA receiver timer value in 1s units.</p> <p>The default time-out value is 40 (40 s).</p>
<p>Note: The above timers are described in the appropriate sections of the relevant CCS7 signaling specifications.</p>			

C7TIMER (continued)**Field descriptions for conditional datafill (Sheet 3 of 3)**

Field	Subfield or refinement	Entry	Explanation and action
	T19	60 to 90	<i>Restart Late TRA filter timer</i> Enter the TRA filter timer value in 1s units. The default time-out value is 67 (67 s).
	T20	5 to 120	<i>Restart overall timer</i> Enter the overall timer value in 1s units. The default time-out value is 59 (59 s).
	T21	5 to 120	<i>Restart adjacent node timer</i> Enter the adjacent node timer value in 1s units. The default time-out value is 63 (63 s).
Note: The above timers are described in the appropriate sections of the relevant CCS7 signaling specifications.			

NETSPEC = TTC704

If the entry in field NETSPEC is TTC704, datafill refinements T2, T4, T18, T19, T20, and T21 as described in the following table.

When a new entry is added in field NETSPEC, the default values from DEFDATA are automatically added. When the entry in field NETSPEC is changed, the default values from DEFDATA are not automatically entered.

C7TIMER (continued)

The value for each timer must be separated from the next by a single space.



CAUTION

Nodal timers are automatically updated for all non-ANSI704 networks

Timers T18 and T20 are nodal. Each nodal timer is to be datafilled the same in all non-ANSI704 networks. When one of these nodal timers is changed in one non-ANSI704 network, the following warning message is issued indicating it has been changed for all non-ANSI704 networks.

WARNING

Nodal timers must be the same in all tuples for a network
 All other tuples for this network type will be modified

Field descriptions for conditional datafill (Sheet 1 of 2)

Field	Subfield or refinement	Entry	Explanation and action
	T2	5 to 250	<p><i>Changeover acknowledgement timer</i></p> <p>Enter the changeover acknowledgement time-out value in 100-ms units.</p> <p>Any entry outside the range indicated for this field is invalid.</p> <p>The default time-out value is 10 (1 s).</p>
	T4	5 to 250	<p><i>Changeback acknowledgement timer (first attempt)</i></p> <p>Enter the changeback acknowledgement time-out value (first attempt) in 100-ms units.</p> <p>Any entry outside the range indicated for this field is invalid.</p> <p>The default value is 10 (1 s).</p>
<p>Note: The above timers are described in the appropriate sections of the relevant CCS7 signaling specifications.</p>			

C7TIMER (continued)**Field descriptions for conditional datafill (Sheet 2 of 2)**

Field	Subfield or refinement	Entry	Explanation and action
	T18	5 to 60	<i>MTP restart STP TRA received timer</i> Enter the signaling links available and TRA received time-out value in 1-s units. The default value is 40 (40 s).
	T19	60 to 90	<i>MTP restart late TRA filter timer</i> Enter the late TRA filter time-out value in 1-s units The default value is 67 (67 s).
	T20	5 to 120	<i>MTP restart overall timer</i> Enter the MTP restart time-out value in 1-s units. The default value is 59 (59 s).
	T21	5 to 120	<i>MTP restart adjacent node timer</i> Enter the TRA message from the adjacent node time-out value in 1-s units. The default value is 63 (63 s).
Note: The above timers are described in the appropriate sections of the relevant CCS7 signaling specifications.			

NETSPEC = ANSI707

If the entry in field NETSPEC is ANSI707, datafill refinements T1 and T3 as described in the following table.

When a new entry is added in field NETSPEC, the default values from DEFDATA are automatically added. When the entry in field NETSPEC is changed, the default values from DEFDATA are not automatically entered.

C7TIMER (continued)

The value for each timer must be separated from the next by a single space.

Field descriptions for conditional datafill

Field	Subfield or refinement	Entry	Explanation and action
	T1	5 to 750	<p><i>Signaling link test acknowledgement timer</i></p> <p>Enter the signaling link test acknowledgement time-out value in 100-ms units.</p> <p>Any entry outside the range indicated for this field is invalid.</p> <p>The default value is 30 (3 s).</p>
	T3	30 to 750	<p><i>Signaling link test interval</i></p> <p>Enter the signaling link test interval in 1-s units.</p> <p>The default value is 60 (60 s).</p>
<p>Note: The above timers are described in the appropriate sections of the relevant CCS7 signaling specifications.</p>			

NETSPEC = CCITT707

If the entry in field NETSPEC is CCITT707, datafill refinements T1 and T3 as described in the following table.

When a new entry is added in field NETSPEC, the default values from DEFDATA are automatically added. When the entry in field NETSPEC is changed, the default values from DEFDATA are not automatically entered.

C7TIMER (continued)

The value for each timer must be separated from the next by a single space.

Field descriptions for conditional datafill

Field	Subfield or refinement	Entry	Explanation and action
	T1	5 to 750	<p><i>Signaling link test acknowledgement timer</i></p> <p>Enter the signaling link test acknowledgement time-out value in 100-ms units.</p> <p>Any entry outside the range indicated for this field is invalid.</p> <p>The default value is 120 (12 s).</p>
	T3	30 to 750	<p><i>Signaling link test interval</i></p> <p>Enter the signaling link test interval in 1-s units.</p> <p>The default value is 90 (90 s).</p>
<p>Note: The above timers are described in the appropriate sections of the relevant CCS7 signaling specifications.</p>			

NETSPEC = NTC707

If the entry in field NETSPEC is NTC707, datafill refinements T1 and T2 as described in the following table.

When a new entry is added in field NETSPEC, the default values from DEFDATA are automatically added. When the entry in field NETSPEC is changed, the default values from DEFDATA are not automatically entered.

C7TIMER (continued)

The value for each timer must be separated from the next by a single space.

Field descriptions for conditional datafill

Field	Subfield or refinement	Entry	Explanation and action
	T1	40 to 120	<p><i>Signaling link test acknowledgement timer</i></p> <p>Enter the signaling link test acknowledgement time-out value in 100-ms units.</p> <p>Any entry outside the range indicated for this field is invalid.</p> <p>The default value is 40 (4 s).</p>
	T2	30 to 90	<p><i>Signaling link test interval timer</i></p> <p>Enter the signaling link interval time-out value in 1-s units.</p> <p>The default value is 60 (60 s).</p>
<p>Note: The above timers are described in the appropriate sections of the relevant CCS7 signaling specifications.</p>			

NETSPEC = JPN707

If the entry in field NETSPEC is JPN707, datafill refinement T10 as described in the following table.

When a new entry is added in field NETSPEC, the default values from DEFDATA are automatically added. When the entry in field NETSPEC is changed, the default values from DEFDATA are not automatically entered.

Field descriptions for conditional datafill

Field	Subfield or refinement	Entry	Explanation and action
	T10	30 to 100	<p><i>Signaling route test timer</i></p> <p>Enter the signaling route test time-out value in 100-ms units.</p> <p>The default time-out value is 100 (10 s).</p>
<p>Note: The above timer is described in the appropriate section of the relevant CCS7 signaling specifications.</p>			

C7TIMER (continued)**NETSPEC = TTC707**

If the entry in field NETSPEC is TTC707, datafill refinement T10 as described in the following table.

When a new entry is added in field NETSPEC, the default values from DEFDATA are automatically added. When the entry in field NETSPEC is changed, the default values from DEFDATA are not automatically entered.

Field descriptions for conditional datafill

Field	Subfield or refinement	Entry	Explanation and action
	T10	30 to 100	<p><i>Signaling link test acknowledgement timer</i></p> <p>Enter the signaling link test acknowledgement time-out value in 100-ms units.</p> <p>The default time-out value is 100 (10 s).</p>
<p>Note: The above timer is described in the appropriate section of the relevant CCS7 signaling specifications.</p>			

NETSPEC = ANSISAAL

If the entry in field NETSPEC is ANSISAAL, datafill the refinements in the following table.

Field descriptions for conditional datafill (Sheet 1 of 4)

Field	Subfield or refinement	Entry	Explanation and action
	SAALT1	1 to 15	<p><i>SAAL T1</i></p> <p>Enter the SSCF time (in units of 1 s) between the link release and the next re-establish action during alignment of the link.</p> <p>The default SAALT1 timer value is 5 (5 s).</p>
	SAALT2	15 to 180	<p><i>SAAL T2</i></p> <p>Enter the total time (in units of 1 s) the SSCF attempts to realign the link.</p> <p>The default SAALT2 timer value is 120 (120 s).</p>

C7TIMER (continued)**Field descriptions for conditional datafill (Sheet 2 of 4)**

Field	Subfield or refinement	Entry	Explanation and action
	SAALT3	72 to 2300	<p><i>SAAL T3</i></p> <p>Enter the SSCF time between proving PDUs in units of 0.1 ms.</p> <p>The default SAALT3 timer value is 90 (9 ms).</p>
	SAALTCC	1 to 20	<p><i>SAAL Timer Connection Controller</i></p> <p>Enter the Connection Control timer value in units of 100 ms.</p> <p>The default SAALTCC timer value is 2 (200 ms).</p>
	SAALKALV	25 to 500	<p><i>SAAL Keep Alive</i></p> <p>Enter the maximum time (in units of 1 ms) that SSCOP can remain in the transient phase.</p> <p>The default SAALKALV timer value is 100 (100 ms).</p>
	SAALNORS	5 to 20	<p><i>SAAL No Response</i></p> <p>Enter the maximum time interval during which at least one STAT PDU must be received. Enter the value in units of 100 ms</p> <p>The default SAALNORS timer value is 15 (1.5 s).</p>
	SAALPOLL	25 to 500	<p><i>SAAL Poll</i></p> <p>Enter the time (in units of 1 ms) between transmitting poll messages.</p> <p>The default SAALPOLL timer value is 100 (100 ms).</p> <p>Note: Nortel recommends using the default value. If you use any other value, the optimal operation of the link can be affected.</p>

C7TIMER (continued)**Field descriptions for conditional datafill (Sheet 3 of 4)**

Field	Subfield or refinement	Entry	Explanation and action
	SAALIDLE	25 to 1000	<p><i>SAAL Idle</i></p> <p>Enter the maximum time (in units of 1 ms) that SSCOP can remain in the idle phase.</p> <p>The default SAALIDLE timer value is 100 (100 ms).</p>
	SAALSREC	1 to 180	<p><i>SAAL Recovery</i></p> <p>Enter the layer management timer (in units of 1 min) for repeat SSCOP recovery.</p> <p>The default SAALSREC timer value is 60 (60 min).</p>
	SAALNOCRD	10 to 60	<p><i>SAAL No Credit</i></p> <p>Enter the maximum time a 0 credit condition can exist before layer management fails the link. Enter the value in units of 100 ms.</p> <p>The default SAALNOCRD timer value is 15 (1.5 s).</p>
	SAALSUP	10 to 600	<p><i>SAAL Superblock</i></p> <p>Enter the layer management superblock size timer value (in units of 1 s).</p> <p>The default SAALSUP timer value is 120 (120 s).</p>
	SAALLOSS	5 to 100	<p><i>SAAL Loss</i></p> <p>Enter the layer management status loss limit timer value in units of 100 ms.</p> <p>The default SAALLOSS timer value is 13 (1.3 s).</p>

C7TIMER (continued)

Field descriptions for conditional datafill (Sheet 4 of 4)

Field	Subfield or refinement	Entry	Explanation and action
	SAALTAU	25 to 500	<p><i>SSCF T3</i></p> <p>Enter the layer management error monitoring interval value (in units of 1 ms).</p> <p>The default SAALTAU timer value is 100 (100 ms).</p>
	SAALPROV	1 to 20	<p><i>SSCF Proving</i></p> <p>Enter the time (in units of 1 min) that layer management is to monitor the status of the link after proving and being placed into service.</p> <p>The default SAALPROV timer value is 10 (10 min).</p>

Datafill example

The following example shows sample datafill for table C7TIMER.

The example shows datafill for network type and specification reference (field NETSPEC) values of ANSI703 and ANSI704, and ANSISAAL.

MAP display example for table C7TIMER

TIMEKEY	TIMEDATA
Q703	0 ANSI703 130 118 118 6 23 12 30 100
Q704	0 ANSI704 10 10 10 10 10 10 15 10 30 69 10 10 3 2 20 10 60 8 90 90 10 10 10 32 13 3 5 62 32 120 660 240
SAAL	0 ANSISAAL 5 120 45 2 100 15 100 100 60 15 120 13 100 10

Table history

TL14

Added timers T33 and T34 for NETSPEC = ANSI704.

C7TIMER (continued)**TL13**

Updated timers' default values for NETSPEC = CCITT703, CCITT704, and CCITT707.

TL11

Removed the SAAL timers datafill restrictions. Added error messages.

TL10

Changed default value for field SAALT3 to 90.

TL09

Added timer T31 to specification reference (SPEC_REF) Q704.

STP04.0

Removed HLIU datafill restrictions.

TL07

Added information on SAAL timers. These fields are visible but not datafillable.

Changed default value for ANSI704 timer T11 to 90 seconds.

TL05

Added nine timers, T22 to T30, to the ANSI704 network type and specification.

STP03

Added four timers, T18 to T21, to the CCITT704, NTC704, TTC704, JPN704 network types and specifications.

Supplementary Information**Error messages**

If the value in table C7TIMER subfield SAALT3 or the value in table C7LKPARM subfield RPDU is too low, the following error message appears:

```
EXCESSIVE PROVING PDU RATE
The following parameter relationship has been violated for
one or more links using this tuple:
{100 000 / c7timer-saal-t3} * 1.2 <= c7lkparm-rpdu
100 000 is a unit conversion factor
1.2 provides a 20% safety margin
```

C7TIMER (continued)

The error message includes an algebraic formula, in which:

- c7timer-saal-t3 indicates the value in table C7TIMER, parameter SAALT3.
- c7lkparm-rpdu indicates the value in table C7LKPARAM, parameter RPDU.

To clear the error message increase one or both values. The following table indicates suggested values for each field.

Suggested values for parameters SAALT3 in table C7TIMER and RPDU in table C7LKPARAM

C7TIMER-SAALT3	C7LKPARAM-RPDU
90 - recommended value	1680 - recommended value
90	1335 to 1680
72 to 2300	1680
90 to 2300	1400

If the value in table C7TIMER subfield SAALT2 is too low or if the values in table C7TIMER subfield SAALT3 and table C7LKPARAM subfield SSCFN1 are too high, the following error message appears:

```
EXCESSIVE PROVING TIME
The following parameter relationship has been violated for
one or more links using this tuple:
{c7timer-saal-t3 * c7lkparm-sscfn1 * 1.2} / 10 000} <=
c7timer-saal-t2
10 000 is a unit conversion factor
1.2 provides a 20% safety margin
```

The error message includes an algebraic formula, in which:

- c7timer-saal-t3 indicates the value in table C7TIMER, parameter SAALT3.
- c7lkparm-sscfn1 indicates the value in table C7LKPARAM, parameter SSCFN1.
- c7timer-saal-t2 indicates the value in table C7TIMER, parameter SAALT2.

C7TIMER (end)

To clear the error message do one or more of the following:

- increase the value in table C7TIMER subfield SAALT2
- decrease the value of table C7TIMER subfield SAALT3
- decrease the value of table C7LKPARAM subfield SSCFN1

The following table indicates suggested values for each field.

Suggested values for parameters SAAL73 in table C7TIMER, SSCFN1 in table C7LKPARAM, and SAALT2 in table C7TIMER

C7TIMER-SAALT3	C7LKPARAM-SSCFN1	C7TIMER-SAALT2
90 - recommended value	6250 - recommended value	120 - recommended value
90	6250	70 to 180
90	50 to 6250	120
90 to 160	6250	120

C7TRKMEM

Table name

CCS7 Trunk Member Table

Functional description

Signaling network identifiers (SNID), which consist of a network identifier, point code, and circuit identification code (CIC), are used by Common Channel Signaling 7 (CCS7) to reference specific circuits (trunks) within the CCS7 network.

Table C7TRKMEM is used by CCS7 to relate the CIC portion of the SNID to the common language location identifier (CLLI) and trunk member number.

For global trunks (GTRK), datafill table TRKBCHNL instead of table C7TRKMEM.

CCS7 ISDN user part (ISUP) trunks and some United Kingdom versions of the user part trunks can be datafilled in this table.

Table C7TRKMEM is indexed at the operating company level by CLLI and MEMNAME (trunk member number). In addition to the table key, table C7TRKMEM contains a field that lists the CIC for the specified trunk. The network and point code portions of a trunk's SNID (identified by its routeset) are stored in table ISUPDEST.

Datafill sequence and implications

The following tables must be datafilled before table C7TRKMEM.

- ISUPDEST
- TRKMEM

Table size

58,000 tuples (default)

100,000 tuples

Note: To enable the above table size, the switch must be equipped with CCS7 external routers.

100,001 to 120,960 tuples

Note: To enable the above tuple range, the switch must be a stand-alone SSP that is equipped with external routing, 32-megabyte LIU7s. The

C7TRKMEM (continued)

external routing must be on, and the value of the Network_Active office parameter must be set to EXTERNET.

For an INode office, you cannot datafill more than 20 k tuples if table C7GTT has more than 25 k tuples.

For more information, refer to the appropriate engineering guidelines.

Datafill

The following table lists datafill for table C7TRKMEM.

Field descriptions

Field	Subfield or refinement	Entry	Explanation and action
MEMKEY		see subfields	<i>Member key</i> This field consists of subfields CLLI and MEMNAME.
	CLLI	alphanumeric (1 to 16 characters)	<i>Common language location identifier</i> Enter the code assigned in table CLLI to the trunk group of which the trunk is a member.
	MEMNAME	numeric (0 to 9999)	<i>Trunk member number</i> Enter the member number assigned to the trunk. This number is assigned in field EXTRKNM of table TRKMEM.
CIC		numeric (0 to 16383)	<i>CCS7 circuit identification code</i> Enter a digit to represent the CIC of the trunk circuit. Allocating CICs contiguously (top down, bottom up, or both) makes the most efficient use of data store. For CCITT trunks, the valid range is limited to 0 to 4095.

Datafill example

The following example shows sample initial datafill for table C7TRKMEM. The example shows the assignment of CICs to the members of trunk groups ISUPINC, ISUPOTG, and ISUP2W.

C7TRKMEM (continued)**MAP display example for table C7TRKMEM**

MEMKEY	CIC
ISUPINC 0	100
ISUPINC 1	101
ISUPINC 2	102
ISUPOTG 0	100
ISUPOTG 1	101
ISUPOTG 2	102
ISUP2W 0	200
ISUP2W 1	201
ISUP2W 2	202

Table history**NA013**

Added new table size range of 100,001 to 120,960 tuples for Succession Network VToA (Voice Trunking Over ATM) application (59012825).

SHR12

Updated table size limits and added an error message (feature 59009405).

CSP08

Added STP SOC and external routing effect on table size.

Supplementary information

This section provides additional information related to table C7TRKMEM.

Data entry error messages

If you try to add an entry that is associated with a subgroup for which no routeset has been defined in table ISUPDEST, the following error message is displayed:

```
A DESTINATION HAS NOT BEEN DEFINED FOR THIS MEMBER'S TRUNK
SUBGROUP - SEE TABLE xxxxDEST
```

CCS7 supports connections to a maximum of 256 CCS7 nodes (network and point code). If you try to datafill table C7TRKMEM with trunk CICs that are associated with more than the maximum number of nodes allowed, the following error message is displayed:

```
LIMIT ON POINT CODE CONNECTIONS EXCEEDED
```

C7TRKMEM (end)

If you try to datafill a trunk using the same CIC and associated routeset as an existing trunk, the following error message is displayed:

```
THE SNID SPECIFIED BY THE ROUTESET (FROM THE xxxxDEST table) AND  
THE CIC JUST ENTERED HAS ALREADY BEEN ALLOCATED
```

Note: While the cause of this error is often obvious, it can be obscured if the user has datafilled multiple ISUPDEST entries with the same routeset.

The range of CICs allowed in a CCITT network is smaller than the range allowed in an American National Standards Institute (ANSI) or NTC7 network (0 to 4095 rather than 0 to 16 383). If you are datafilling a CCITT trunk and have provided a CIC greater than 4095, the following error message is displayed:

```
INVALID CIRCUIT ID CODE FOR CCITT NETWORK
```

If the table control software is unable to establish a context in which to interpret the CIC just entered, this means that no associated entries exist in tables TRKMEM and TRKSGRP. In this case, an attempt to add an entry to table C7TRKMEM results in the display of the standard error message:

```
UNEXPECTED ERROR CONDITION
```

For an INode office, if table C7GTT has more than 25 k tuples, you cannot datafill more than 20 k tuples in table C7TRKMEM. If you try, the system displays the following error message:

```
Table C7TRKMEM is at the limit of 20 000 tuples. This limit is  
for offices functioning as INodes if Table C7GTT contains more  
than 25 000 tuples. Tuple NOT added.
```

C7UPTMR

Table name

CCS7 Signaling ISUP Timers Table

Functional description

Table C7UPTMR contains call processing and maintenance timers. The timers are datafilled according to trunk subgroup.

Table TRKSGRP contains field TMRNAME, which is also the key to table C7UPTMR. The entry in field TMRNAME connects one or more trunk subgroups to one tuple in table C7UPTMR.

You use table C7UPTMR to datafill sets of timers. The timers are assigned according to the direction and protocol fields of table C7UPTMR.

The following protocols can be datafilled in table C7UPTMR:

- AISUP is used for all versions of Australian ISDN user part (ISUP) in DMS-100 switches that include
 - Australian ISUP (AISUP)
 - Interconnect-ISUP (I-ISUP)
 - Malaysian ISUP (MISUP)
 - Philippines telephone user part (TUP) (PTUP)
- ATUP is used for the Australian telephone user part for DMS-100 and DMS-300 switches
- BTUP is used for the United Kingdom (UK) variant of national user part
- CCITT250 is used for CCITT ISUP on DMS-250 switches
- CTUP is used for China telephone user part for DMS-100i and DMS GL-100 switches
- IBNISUP is used for Integrated Business Network 7 (IBN7), also known as American National Standards Institute 7 (ANSI7), call processing, and IBN7-to-IBN7 for global networking (GN) calls
- JPNISUP is used for Japan Public Network 7 (JPN7) trunks in DMS-100 switches
- MBTUP is used for interworking within operating company-specific networks
- NCCI is used if the operating company-specific CCITT7 protocols (NCCI7) are packaged on the DMS-100 switch
- Q764 is used for American National Standards Institute (ANSI) ISUP

C7UPTMR (continued)

- Q767 is used for ITU-T/ETSI ISUP in DMS-100 switches
- RBTUP is used for any Redbook TUP protocol
- TUP_BLUE is used by the DMS-300 switch for interworking with signaling 7 protocols BTUP and TUPPLUS (TUP+)
- TUPPLUS is used for interworking BTUP with telephone user part plus (TUP+) (or any other signaling 7 protocol)

Note: Datafill in table C7UPTMR that references a particular protocol is ineffective unless the functionality that supports the protocol is installed. See the following table for a list of required feature packages for each protocol.

Functionalities supporting protocols (Sheet 1 of 2)

Protocol	Functionality
AISUP	Australian ISUP for DMS-100
ATUP	Australian TUP for DMS-100 DMS-300 Australian ISUP
BTUP	BTUP on DMS-300
CCITT250	DMS-300 International CCITT ISUP (Q.767) & ETSI ISUP
CTUP	International China TUP for DMS-100
IBNISUP	DMS-300 ANSI7+ Services
JPNISUP	JPN ISUP Trunk Signaling
MBTUP	BTUP on DMS-300
NCCI	DMS-100 NCCI#7 to ANSI7+ Interworking CCITT #7 and NCCI #7 for DMS-100
Q764	DMS-300 ANSI7+ Services International ANSI ISUP
Q767	ETSI ISUP, including all versions and national variants currently supported
RBTUP	Standard Redbook TUP, SSUTR2 (French TUP), and Brazilian TUP

C7UPTMR (continued)**Functionalities supporting protocols (Sheet 2 of 2)**

Protocol	Functionality
TUP_BLUE	DMS-300 ANSI7+Blue Book TUP I/W TUP Blue Book on DMS-300
TUPPLUS	TUP(+) on DMS-300
general	ATUP-ANSI ISUP/AISUP Interworking

Three directions can be datafilled:

- 2W (two-way)
- IC (incoming)
- OG (outgoing)

The sets of timers are as follows:

- AISUP incoming, outgoing, and two-way timers
- ATUP incoming, outgoing, and two-way timers
- BTUP incoming, outgoing, and two-way timers
- CCITT incoming, outgoing, and two-way timers
- CTUP incoming, outgoing, and two-way timers
- IBNISUP incoming, outgoing, and two-way timers
- JPNISUP incoming, outgoing, and two-way timers
- MBTUP incoming, outgoing, and two-way timers
- NCCI incoming, outgoing, and two-way timers
- Q764 incoming, outgoing, and two-way timers
- Q767 two-way timers
- Q767 incoming timers (for SSUTR2 only)
- Q767 outgoing timers (for SSUTR2 only)
- RBTUP incoming, outgoing, and two-way timers
- TUP_BLUE incoming, outgoing, and two-way timers
- TUPPLUS incoming, outgoing, and two-way timers

Any set of timers can be datafilled more than once. For example, table TRKSGRP can contain two tuples that require incoming CCITT timers, but

C7UPTMR (continued)

require different values for the timers. The entry in field TMRNAME (timer name) is different for each tuple in table C7UPTMR.

The direction, protocol, and timer name (TMRNAME) values of table TRKSGRP must also exist in a tuple of table C7UPTMR. If this requirement is not met, the entry in table TRKSGRP is not valid.

Q33 timer on DMS-300 gateway

If the Q33 option is present in the load, field OPTION is always visible, but is present only on selected incoming and two-way trunks.

The Q33 option cannot be deleted from table C7UPTMR if it is referenced by a tuple in table TRKSGRP that is datafilled with the Q33SUP option. The Q33SUP option must first be deleted from table TRKSGRP and then the Q33 option can be deleted from table C7UPTMR.

ANSI ISUP on DMS-300 gateway

The DMS-300 gateway switch can support ANSI7 Signaling ISUP trunks and interwork calls on these trunks with CCITT No. 7 Signaling (N7) ISUP trunk calls.

ANSI trunks use ANSI timer values that are defined in table C7UPTMR. An ANSI timer must be datafilled in table C7UPTMR.

Datafill sequence and implications

The following tables must be datafilled before table C7UPTMR:

- TRKGRP
- TRKMEM
- TRKBCHNL
- all message transfer part (MTP) tables
- ISUPDEST
- C7TRKMEM

The following tables must be datafilled after table C7UPTMR:

- TRKSGRP

Table size

0 to 31 tuples

The maximum number of tuples that can be datafilled is 31, with one tuple assigned the value NIL.

C7UPTMR (continued)**Datafill**

The following table lists datafill for table C7UPTMR.

Field descriptions

Field	Subfield	Entry	Explanation and action
TMRKEY		alphanumeric (1 to 16 characters)	<i>Timer key</i> Enter a name that is the key to the table and is datafilled in table TRKSGRP. For global trunks (GTRK), enter a name that is the key to the table and is datafilled in table TRKSIGPF.
C7UPDIR		2W, IC, or OG	<i>C7 trunk direction</i> If the trunk direction is two-way (or both ways), enter 2W. If the trunk direction is incoming, enter IC. If the trunk direction is outgoing, enter OG.
TMRS		see subfield	<i>Timers</i> This field contains subfield PROT. Datafill for subfield PROT depends on the signaling protocol.
	PROT	AISUP, ATUP, BTUP, CCITT250, CTUP, IBNISUP, JPNISUP, MBTUP, NCCI, Q764, Q767, RBTUP, TUP_BLUE, or TUPPLUS	Enter the required protocol, and enter the remaining datafill for subfield PROT as described in this document.

Table history**MMP13**

Added field VARIANT in protocol RBTUP.

EUR010

Added references to protocol Q767.

APC008

Added support to AISUP for I-ISUP, MISUP, and PTUP timers.

EUR008

Added timers for RBTUP protocol.

EUR006

Added support for CCITT ISUP variants by increasing the maximum ranges of values for the following fields from 180 to 300:

- NQ764T5, NQ764T13, NQ764T15, NQ764T17, NQ764T19, NQ764T21 and NQ764T23

These timers and their ranges are described in *ITU Q.761 to Q.764*.

GL02

Added China telephone user part (CTUP) timers.

APC004

An optional minimum charge duration (MCD) timer was added to field OPTIONS for IC and 2W AISUP, ATUP, and Q764 protocols.

BCS36

The following changes were implemented:

- Added note to field PROT.
- Added entry Q33 to field OPTION for IC and 2W BTUP, CCITT250, TUP_BLUE, and TUPPLUS protocols.
- Corrected ranges for field TUPT10.
- Removed fields Q118_1 and Q118_2 for protocol BTUP.
- Removed fields NQ764T35 and NQ764537 for protocol CCITT250.

CAINCONV

Table name

Carrier Advanced Intelligent Network Conversation (CAINCONV) table

Functional description

Table CAINCONV is one of five tables creating an SCP simulator for use in testing Carrier AIN functionality.

Table CAINCONV controls when the SCP simulator enters into conversation with the switch. Refer to the *UCS DMS-250 NetworkBuilder Application Guide* for more information on the SCP Simulator.

Datafill sequence and implications

Enter a value into field RESP_IDX in table CAINRESP before the switch can accept the tuple in table CAINCONV.

Table size

0 to 1535 tuples

A fixed amount of store is reserved when table CAINCONV is allocated at IPL time. If the table grows beyond the initial store size, additional memory blocks will be requested as needed. Table size may only increase; once additional blocks have been requested, they cannot be deallocated.

Field descriptions

The following table describes field names, subfield names, and valid data ranges for table CAINKEY.

CAINCONV field descriptions (Sheet 1 of 2)

Field	Subfield or refinement	Entry	Explanation and action
KEY		1 to 1535	KEY. Enter a unique number to identify the tuple to match. This field is indexed by field CONV_IDX in table CAINMTCH.

CAINCONV (continued)**CAINCONV field descriptions (Sheet 2 of 2)**

Field	Subfield or refinement	Entry	Explanation and action
CRITERIA		Vector of up to 5 vectors of digit strings whose individual length goes up to 24 digits (0 to 9, *, #)	CRITERIA. Datafill a digit string; enter up to 5 strings. The digit strings are compared with the digits received from the switch in a <i>Resource_Clear</i> message. Any group of digits at the lowest level of the vector must contain the same number of digits that the SSP returns to the SCP or no match occurs.
RESP_IDX		Valid RESPKEY datafilled in table CAINRESP	RESPONSE INDEX. Enter a valid RESPKEY datafilled in table CAINRESP.

Datafill example

The following example shows sample datafill for table CAINCONV.

```
KEY CRITERIA RESP_IDX
-----
1 (2146841000) $ VALID01
2 (1234) $ VALID02
3 (123) (766) $ VALID03
```

The following example shows sample datafill for the *Send_To_Resource* without CAINPRT

```
400 (12341234) (5432154321) (7676) $ VALIDADDR01
```

The following example shows sample datafill for the *Send_To_Resource* with CAINPRT

CAINCONV (end)

```
500 (9876543210) $ VALIDADDR01
600 (1111) (22222) (3333) (444) (55555) $ VALIDADDR01
```

Table history

UCS08

Feature AX0188 and Feature AX0190 expand the criteria field to a vector of up to 5 vectors of digit strings with an individual length of up to 24 digits.

UCS07

Field RESP_IDX is modified to index RESPKEY in table CAINRESP.

UCS06

Table CAINCONV was created.

CAINGRP

Table name

Carrier Advanced Intelligent Network Group (CAINGRP) table

Functional description

Table CAINGRP provides a mapping between the CAIN group and the triggers at each trigger detection point (TDP) for the specified points in call (PIC). Once the switch makes this mapping, then it can find more detailed information in a trigger table. Table CAINGRP also defines the groups available for CAIN services subscription. Subscription to the groups defined in table CAINGRP is determined in the following tables:

- SCP-returned - provides CAIN subscription for SCP-returned CAIN groups
- STDPRTCT - provides CAIN subscription for addresses
- ANISCUSP, or UNIPROF and ANIVAL - provides CAIN subscription for ANIs
- AUTHCODU, AUTHCDU2, AUTHCDU3, AUTHCDU4, and AUTHCDU5 - provides CAIN subscription for authorization codes
- TRKGRP - provides CAIN subscription for PTS DAL, PTS FGD, SS7 FGD originating agencies, and SS7 Inter Machine Trunks
- TRKFEAT - provides CAIN subscription for AXXESS trunks
- CALLATTR - provides CAIN subscription for PRI call attributes
- CAINPARAM (parameter CAIN_OFFICE_GROUP) - provides office-wide CAIN subscription

Each CAIN group includes one or more triggers and provides an index into the triggering tables.

Refer to the *UCS DMS-250 NetworkBuilder Application Guide* for more information on defining CAIN groups and trigger sets.

Datafill sequence and implications

Datafill table CAINGRP before the following tables:

- CAINPARAM
- CAINXDFT
- OFFHKIMM
- OFTRREQ
- OFFHKDEL

CAINGRP (continued)

- SIOTRK
- PRIBCHNL
- SPECFEAT
- CUSTDP
- SPECDIG
- OFFCCODE
- NETBUSY
- OCLDBUSY
- ONOANSWR
- OIECREO
- TERMATT

Note 1: Define a CAIN group before subscribing an address, authcode, ANI, agent, or office to CAIN services.

Note 2: CAIN services require provisioning of originating agents in table TRKGRP, TRKFEAT, or CALLATTR.

Table size

0 to 4095 tuples

Field descriptions

The following table describes field names, subfield names, and valid data ranges for table CAINGRP.

CAINGRP field descriptions (Sheet 1 of 4)

Field	Subfield or refinement	Entry	Explanation and action
CAINGRP		Up to 16 alphanumeric characters	CARRIER AIN GROUP. Enter an alphanumeric name identifying the CAIN group. This field is the key for table CAINGRP.
GRPNUM		0 to 4095	GROUP NUMBER. Enter a unique number to identify the CAIN group. The GRPNUM may be sent to the SCP in the <code>cainGroup</code> extension parameter.
MSGSET		CAIN02, IN1	MESSAGE SET. Enter the messaging protocol used by CAIN call processing.

CAINGRP (continued)**CAINGRP field descriptions (Sheet 2 of 4)**

Field	Subfield or refinement	Entry	Explanation and action
PROTO		TCAP_SCCP	TRANSPORT MECHANISM. Enter the messaging transport mechanism used by CAIN call processing.
TRIGRSET			TRIGGER SET. If the message set is CAIN02, enter a vector of 9 multiples and datafill the PIC, TDP and TRIGGER refinements. If the message set is IN1, enter value TOLLFREE as TRIGRSET refinement.
	PIC		POINT IN CALL. Enter the PIC associated with the required trigger.
		O_NULL	Enter O_NULL to indicate PIC 1, <i>O_Null</i> . See PIC=O_NULL for refinement datafill.
		COLLINFO	Enter COLLINFO to indicate PIC 3, <i>Collect_Information</i> . See PIC=COLLINFO for refinement datafill.
		ANLZINFO	Enter ANLZINFO to indicate PIC 4, <i>Analyze_Information</i> . See PIC=ANLZINFO for refinement datafill.
		SELROUTE	Enter SELROUTE to indicate PIC 5, <i>Select_Route</i> . See PIC=SELROUTE for refinement datafill.
		SEND_CALL	Enter SEND_CALL to indicate PIC 7, <i>Send_Call</i> . See PIC=SEND_CALL for refinement datafill.
		O_ALERTG	Enter O_ALERTG to indicate PIC 8, <i>O_Alerting</i> . See PIC=O_ALERTG for refinement datafill.
		O_ACTIVE	Enter O_ACTIVE to indicate PIC 9, <i>O_Active</i> . See PIC=O_ACTIVE for refinement datafill.
		T_NULL	Enter T_NULL to indicate PIC 11, <i>Termination_Attempt</i> . See PIC=T_NULL for refinement data.
		NIL	Enter NIL in the PIC subfield to remove an existing trigger.

CAINGRP (continued)

CAINGRP field descriptions (Sheet 3 of 4)

Field	Subfield or refinement	Entry	Explanation and action	
OPTIONS	TDP		TRIGGER DETECTION POINT. Enter the TDP associated with the CAINGRP. This refinement is based on the PIC value provisioned. For TDP values, refer to the tables on PIC refinements.	
	TRIGGER		TRIGGER. Enter trigger associated with the CAINGRP. This refinement is based on the PIC and TDPs provisioned. For PIC and TDP values, refer to tables on PIC refinements.	
		TOLLFREE	The TOLLFREE trigger is supported when the MSGSET refinement is IN1.	
		Vector of up to 5 multiples	OPTIONS. Datafill this field to specify optional features; enter up to five options.	
		NIL	Enter NIL to remove an option.	
		OANSTIME	Enter OANSTIME to activate the O_No_Answer_Time option. Datafill the OANSTIME refinement.	
		OANSTIME	1 to 120	Enter the time, in seconds, that the switch should wait for call answer before encountering the O_No_Answer TDP or EDP.
		OVRREORG		Indicates that CAIN should override all SSP features and allow reorigination. Enter the REOTYPE refinement.
		REOTYPE	AUTO, MANUAL	The subfields specify the type of reorigination, AUTO or MANUAL. If REOTYPE is MANUAL, enter REOKEY refinement.
		REOKEY	AST, OCT	The subfields also specify the reorigination key (AST or OCT) for MANUAL reorigination.
EXTPARMS		Vector of up to 6 multiples	EXTENSION PARAMETERS. Enter the list of extension parameters to be delivered in an originating call model query message to the SCP; enter up to 6 extension parameters.	
		NIL	Enter NIL to remove an extension parameter from the list.	

CAINGRP (continued)**CAINGRP field descriptions (Sheet 4 of 4)**

Field	Subfield or refinement	Entry	Explanation and action
TEXT- PARMS		ADIN	Enter ADIN to deliver the authcode database index associated with the originating agency in the <code>adin</code> extension parameter.
		CAINGRP	Enter CAINGRP to deliver the triggering CAIN group's GRPNUM in the <code>cainGroup</code> extension parameter.
		ORGTINFO	Enter ORGTINFO to deliver the originating trunk member and agency type in the <code>origTrunkInfo</code> extension parameter.
		Vector of up to 6 multiples	TERMINATING EXTENSION PARAMETERS. Enter the list of extension parameters to be delivered in a terminating call model query message to the SCP.
		NIL	Enter NIL to remove an extension parameter from the list.
		TERMTINFO	Enter TERMTINFO to deliver the terminating trunk member and agency type in the <code>termTrunkInfo</code> extension parameter.
		CAINGRP	Enter CAINGRP to deliver the triggering CAIN group's GRPNUM in the <code>cainGroup</code> extension parameter.
		ORGTINFO	Enter ORGTINFO to deliver the originating trunk member and agency type in the <code>origTrunkInfo</code> extension parameter.

CAINGRP (continued)

PIC=O_NULL

When PIC=O_NULL, datafill the following:

Subfield PIC=O_NULL refinements

Subfield	Subfield or refinement	Entry	Explanation and action
TDP		ORIGATT	TRIGGER DETECTION POINT. Enter ORIGATT to indicate the <i>Origination_Attempt</i> TDP.
TRIGGER		OFFHKIMM	TRIGGER. Enter OFFHKIMM to indicate the <i>Off_Hook_Immediate</i> trigger.

PIC=COLLINFO

When PIC=COLLINFO, datafill the following:

PIC=COLLINFO refinements (Sheet 1 of 2)

Field	Subfield or refinement	Entry	Explanation and action
TDP			TRIGGER DETECTION POINT. Enter the TDP associated with the required trigger.
		INFOCOLL	Enter INFOCOLL to indicate the <i>Info_Collected</i> TDP.
		OFTRREQ	Enter OFTRREQ to indicate the <i>O_Feature_Requested</i> TDP.
TRIGGER			TRIGGER. Enter the required trigger.
		OFTRREQ	Enter OFTRREQ to indicate the <i>O_Feature_Requested</i> trigger.
			Note: The <i>O_Feature_Requested</i> trigger is only available in conjunction with the <i>O_Feature_Requested</i> TDP and the <i>Collect_Information</i> PIC.
		OFFHKDEL	Enter OFFHKDEL to indicate the <i>Off-Hook_Delay</i> trigger.

CAINGRP (continued)**PIC=COLLINFO refinements (Sheet 2 of 2)**

Field	Subfield or refinement	Entry	Explanation and action
		SIOTRK	Enter SIOTRK to indicate the <i>Shared_Interoffice_Trunk</i> trigger. Note: The <i>Shared_Interoffice_Trunk</i> trigger is only available in conjunction with the <i>Info_Collected</i> TDP and the <i>Collect_Information</i> PIC.
		PRIBCHNL	Enter PRIBCHNL to indicate the <i>PRI_B-Channel</i> trigger. Note: The <i>PRI_B-Channel</i> trigger is only available in conjunction with the <i>Info_Collected</i> TDP and the <i>Collect_Information</i> PIC.

PIC=ANLZINFO

When PIC=ANLZINFO, datafill the following:

Subfield PIC=ANLZINFO refinements

Subfield	Subfield or refinement	Entry	Explanation and action
TDP		INFOANLZ	TRIGGER DETECTION POINT. Enter INFOANLZ to indicate the <i>Info_Analyzed</i> TDP.
TRIGGER			TRIGGER. Enter the required trigger.
		SPECFEAT	Enter SPECFEAT to indicate the <i>Specific_Feature_Code</i> trigger.
		CUSTDP	Enter CUSTDP to indicate the <i>Customized_Dialing_Plan</i> trigger.
		SPECDIG	Enter SPECDIG to indicate the <i>Specific_Digit_String</i> trigger.
		OFFCCODE	Enter OFFCCODE to indicate the <i>Office_Code</i> trigger.

CAINGRP (continued)**PIC=SELROUTE**

When PIC=SELROUTE, datafill the following:

PIC=SELROUTE refinements

Field	Subfield or refinement	Entry	Explanation and action
TDP		NETBUSY	TRIGGER DETECTION POINT. Enter NETBUSY to indicate the <i>Network_Busy</i> TDP.
TRIGGER		NETBUSY	TRIGGER. Enter NETBUSY to indicate the <i>Network_Busy</i> trigger.

PIC=SEND_CALL

When PIC=SEND_CALL, datafill the following:

Subfield PIC=SEND_CALL refinements

Subfield	Subfield or refinement	Entry	Explanation and action
TDP		OCLDBUSY	TRIGGER DETECTION POINT. Enter OCLDBUSY to indicate the <i>O_Called_Party_Busy</i> TDP.
TRIGGER		OCLDBUSY	TRIGGER. Enter OCLDBUSY to indicate the <i>O_Called_Party_Busy</i> trigger.

PIC=O_ALERTG

When PIC=O_ALERTG, datafill the following:

Subfield PIC=O_ALERTG refinements

Field	Subfield or refinement	Entry	Explanation and action
TDP		ONOANSWR	TRIGGER DETECTION POINT. Enter ONOANSWR to indicate the <i>O_No_Answer</i> TDP.
TRIGGER		ONOANSWR	TRIGGER. Enter ONOANSWR to indicate the <i>O_No_Answer</i> trigger.

CAINGRP (continued)**PIC=O_ACTIVE**

When PIC=O_ACTIVE, datafill the following:

Subfield PIC=O_ACTIVE refinements

Field	Subfield or refinement	Entry	Explanation and action
TDP		OMIDCALL	TRIGGER DETECTION POINT. Enter OMIDCALL to indicate the <i>O_Mid_Call</i> TDP.
TRIGGER		OIECREO	TRIGGER. Enter OIECREO to indicate the <i>O_IEC_Reorigination</i> trigger.

PIC=T_NULL

When PIC=T_NULL, datafill the following:

Subfield PIC=T_NULL refinements

Field	Subfield or refinement	Entry	Explanation and action
TDP		TERMATT	TRIGGER DETECTION POINT. Enter TERMATT to indicate the <i>Termination_Attempt</i> TDP.
TRIGGER		TERMATT	TRIGGER. Enter TERMATT to indicate the <i>Termination_Attempt</i> trigger.

Datafill example

The following example shows datafill for table CAINGRP.

CAINGRP (continued)

```
VPNGRP 2 CAIN02 TCAP_SCCP (ANLZINFO
INFOANLZ CUSTDP) $ $ (ADIN) (CAINGRP
)(ORGTINFO) $ $

ANIGRP 5 CAIN02 TCAP_SCCP (ANLZINFO
INFOANLZ   SPECDIG)   $   $   (ADIN)
(CAINGRP)(ORGTINFO ) $ $

TR533 15 IN1 TCAP_SCCP (TOLLFREE) $
$ $ $

OFFGRP 20 CAIN02 TCAP_SCCP (O_NULL
ORIGATT   OFFHKIMM)   $   $   (ADIN)
(CAINGRP )(ORGTINFO ) $ $
```

Table history**UCS09**

Updated field MSGSET and TRIGRSET to include values IN1, TOLLFREE (AX1377).

UCS08

Feature AX0186 added the following:

- value O_ACTIVE to TRIGRSET field
- value OVRREORG {AUTO, MANUAL {AST, OCT}} to OPTIONS field

Feature AX0187 added Trigger SPECFEAT to field ANLZINFO.

Feature AX0197 added field TEXTPARMS so that the `cainGroup`, `origTrunkInfo`, and `termTrunkInfo` extension parameters can be optionally sent in terminating call model queries to the SCP on a CAINGRP basis.

Feature AX0197 added value T_NULL to TRIGRSET field.

Feature AX0201 added the OFFHKDEL trigger.

UCS07

Added OFFCCODE as a trigger type when PIC=ANLZINFO.

UCS06

The following fields are added:

- GRPNUM
- EXTPARMS

The following fields are changed:

- TRIGRSET - The following TRIGRSETs are added:
 - O_NULL ORIGATT OFFHKIMM
 - COLLINFO INFOCOLL SIOTRK
 - COLLINFO INFOCOLL PRIBCHNL
 - COLLINFO OFTRREQ OFTRREQ
 - SELROUTE NETBUSY NETBUSY
 - SEND_CALL OCLDBUSY OCLDBUSY
 - O_ALERTG ONOANSWR ONOANSWR
- OPTIONS - A new OANSTIME option is added.

The size of the table was increased from 2048 tuples to 4096.

UCS05

Table CAINGRP was created.

CAINKEY

Table name

Carrier Advanced Intelligent Network Key (CAINKEY) table.

Functional description

Table CAINKEY creates an SCP simulator for use in testing Carrier AIN functionality.

Table CAINKEY provides the first level of screening for calls entering the simulator. The CAIN query content is compared to the KEY field. When a match is found, the PMI field indexes table CAINMTCH.

Refer to the *UCS DMS-250 NetworkBuilder Application Guide* for more information on the SCP simulator.

Datafill sequence and implications

Datafill table CAINUID before table CAINKEY.

Table size

0 to 1500 tuples

Memory requirements

Table CAINKEY allocates 286 kbytes of memory.

Field descriptions

The following table describes field names, subfield names, and valid data ranges for table CAINKEY.

CAINKEY field descriptions (Sheet 1 of 7)

Field	Subfield or refinement	Entry	Explanation and action
KEY		see subfields	KEY. Datafill the 4-part key consisting of: CAIN_OPER, USERID_SELECTOR, USERID_VALUE, and TRIGGER_CRITERIA.
	CAIN_OPER		CAIN OPERATION. This field identifies the message type for the query.
		NIL	Enter NIL as a wildcard to reduce the number of tuples in this table. When you enter NIL, any message received from the switch is considered a match.

CAINKEY (continued)**CAINKEY field descriptions (Sheet 2 of 7)**

Field	Subfield or refinement	Entry	Explanation and action
		INFO_ANALYZED	<i>Info_Analyzed</i> message
		ORINATION_ATTEMPT	<i>Origination_Attempt</i> message
		INFO_COLLECTED	<i>Info_Collected</i> message
		NETWORK_BUSY	<i>Network_Busy</i> message
		O_CALLED_PARTY_BUSY	<i>O_Called_Party_Bus</i> message
		O_FEATURE_REQUESTED	<i>O_Feature_Requested</i> message
		O_NO_ANSWER	<i>O_No_Answer</i> message
		O_MID_CALL	<i>O_Mid_Call</i> message
		TIMEOUT	<i>Timeout</i> EDP-Request message
		TERMINATION_ATTEMPT	<i>Termination_Attempt</i> message
		START	<i>Start</i> message
		FAILURE_OUTCOME	<i>Failure_Outcome</i> message
		OABANDON	<i>O_Abandon</i> message

CAINKEY (continued)**CAINKEY field descriptions (Sheet 3 of 7)**

Field	Subfield or refinement	Entry	Explanation and action
		ODISC	<i>O_Disconnect</i> message
	USERID_SELECTOR		SELECTOR TYPE. This field identifies what type of key will be used.
		CAIN	Enter the switch ID and trunk group number for the CAIN selector datafilled in Table CAINUID.
		DN	Enter a ten-digit dialed number for the DN selector.
		TRK	Enter a TrunkGroupID in the range 0 to 9999 for the TRK selector.
		IN1	Enter a 3 digit LATA number for the IN1 selector.
		PRIVFAC	Enter a private facility number in the range 0 to 9999 for the PRIVFAC selector.
	USERID_VALUE	valid index into table CAINUID	USER IDENTIFICATION VALUE. If the selector is CAIN, enter a 2-part index into table CAINUID consisting of CAINUID_SWITCH_NAME and CAINUID_CLLI.
	TRIGGER_CRITERIA		TRIGGER CRITERIA. This field contains the trigger criteria type.
		NIL	Enter NIL as a wildcard to reduce the number of tuples in this table. When you enter NIL, any message received from the switch is considered a match.
		OFFHKDEL	Enter OFFHKDEL to indicate an <i>Off_Hook_Delay</i> trigger.
		SPECFEAT	Enter SPECFEAT to indicate a <i>Specific_Feature_Code</i> trigger.
		CUST_INT	Enter CUST_INT to indicate a <i>Customized_Dialing_Plan</i> trigger.

CAINKEY (continued)**CAINKEY field descriptions (Sheet 4 of 7)**

Field	Subfield or refinement	Entry	Explanation and action
		SDS_ADDR	Enter SDS_ADDR to indicate a national address for the <i>Specific_Digit_String</i> trigger or <i>Office_Code</i> trigger. Maps to NPA_NXXXXXX for <i>Office_Code</i> trigger.
		SDS_INTL	Enter SDS_INTL to indicate an international address for the <i>Specific_Digit_String</i> trigger.
		SDS_ANI	Enter SDS_ANI to indicate an automatic number identification for the <i>Specific_Digit_String</i> trigger.
		SDS_N00	Enter SDS_N00 to indicate a N00 address for the <i>Specific_Digit_String</i> trigger.
		SDS_INFO	Enter SDS_INFO to indicate information digits for the <i>Specific_Digit_String</i> trigger.
		SDS_CIC	Enter SDS_CIC to indicate Carrier Identification Code digits for the <i>Specific_Digit_String</i> trigger.
		SDS_ADIN	Enter SDS_ADIN to indicate an Authcode Database Index for the <i>Specific_Digit_String</i> trigger.
		OFFHKIM	Enter OFFHKIM to indicate an <i>Off_Hook_Immediate</i> trigger.
		CSP_CLID	Enter CSP_CLID to indicate a Calling Line Identification for the <i>PRI_B-Channel</i> trigger.
		CSP_ADDR	Enter CSP_ADDR to indicate a national address for the <i>PRI_B-Channel</i> trigger.
		CSP_N00	Enter CSP_N00 to indicate a N00 address for the <i>PRI_B-Channel</i> trigger.
		CSP_INTL	Enter CSP_INTL to indicate an international address for the <i>PRI_B-Channel</i> trigger.

CAINKEY (continued)**CAINKEY field descriptions (Sheet 5 of 7)**

Field	Subfield or refinement	Entry	Explanation and action
		CSP_ADIN	Enter CSP_ADIN to indicate a Authcode Database Index for the <i>PRI_B-Channel</i> trigger.
		PRI_STD	Enter PRI_STD to indicate a <i>ChannelSetupPRI</i> trigger criteria for the <i>PRI_B-Channel</i> trigger.
		SIO_ANI	Enter SIO_ANI to indicate a <i>Shared_Interoffice_Trunk</i> ANI trigger.
		SIO_ADDR	Enter SIO_ADDR to indicate a <i>Shared_Interoffice_Trunk</i> national address trigger.
		SIO_N00	Enter SIO_N00 to indicate a <i>Shared_Interoffice_Trunk</i> N00 address trigger.
		SIO_INFO	Enter SIO_INFO to indicate a <i>Shared_Interoffice_Trunk</i> information digits trigger.
		SIO_INTL	Enter SIO_INTL to indicate a <i>Shared_Interoffice_Trunk</i> international address trigger.
		SIO_CIC	Enter SIO_CIC to indicate a <i>Shared_Interoffice_Trunk</i> CIC trigger.
		SIO_ADIN	Enter SIO_ADIN to indicate a <i>Shared_Interoffice_Trunk</i> Authcode Database Index trigger.
		SIO_STD	Enter SIO_STD to indicate a <i>sharedIOTrunk</i> standard trigger criteria for the <i>Shared_Interoffice_Trunk</i> trigger.
		NETWBSY	Enter NETWBSY to indicate a <i>Network_Busy</i> trigger.
		O_CLDBSY	Enter O_CLDBSY to indicate an <i>O_Called_Party_Busy</i> trigger.

CAINKEY (continued)**CAINKEY field descriptions (Sheet 6 of 7)**

Field	Subfield or refinement	Entry	Explanation and action
		O_NOANSW	Enter O_NOANSW to indicate an <i>O_No_Answer</i> trigger.
		O_FEAT	Enter O_FEAT to indicate an <i>O_Feature_Requested</i> trigger.
		NPA	Enter NPA to indicate a three digit address for the <i>Office_Code</i> trigger.
		NPA_N	Enter NPA_N to indicate a four-digit address for the <i>Specific_Digit_String</i> trigger.
		NPA_NX	Enter NPA_NX to indicate a five-digit address for the <i>Specific_Digit_String</i> trigger.
		NPA_NXX	Enter NPA_NXX to indicate a six-digit address for an <i>Office_Code</i> or a <i>Specific_Digit_String</i> trigger.
		NPA_NXXX	Enter NPA_NXXX to indicate a seven-digit address for an <i>Office_Code</i> or a <i>Specific_Digit_String</i> trigger.
		NPA_NXXXX	Enter NPA_NXXXX to indicate an eight-digit address for an <i>Office_Code</i> or a <i>Specific_Digit_String</i> trigger.
		NPA_NXXXXX	Enter NPA_NXXXXX to indicate a nine digit address for an <i>Office_Code</i> or <i>Specific_Digit_String</i> trigger.
		LNP_OFCD	Enter LNP_OFCD to indicate an <i>Office_Code</i> trigger.
		EDPREQ	Enter EDPREQ to indicate an EDP-request.
		OIECREO	Enter OIECREO to indicate an <i>O_IEC_Reorigination</i> trigger
		TERM_ATT	Enter TERM_ATT to indicate a <i>Termination_Attempt</i> trigger.

CAINKEY (continued)**CAINKEY field descriptions (Sheet 7 of 7)**

Field	Subfield or refinement	Entry	Explanation and action
		TOLLFREE	Enter TOLLFREE to indicate a <i>TollFree_Service</i> trigger.
PMI		vector of up to 9 indices in the range of 0 to 3007	PARAMETER MATCHING INDEX. This field contains up to 9 PMI indexes into table CAINMTCH. A range of indexes is identified by separating two numbers with a "_". For example, 7_10 indexes the seventh, eighth, ninth, and tenth tuple and checks for matching criteria in each.

Datafill example

The following example shows datafill for table CAINKEY.

```
O_ABANDON CAIN DALLAS EAN632 EDPREQ
(1756_1761) $

O_DISCONNECT CAIN DALLAS DAL228 EDPREQ
(1750_1755) $

TIMEOUT CAIN DALLAS AXDAL274 EDPREQ
(298) $

START IN1 003 TOLLFREE (992) $
```

Table history**UCS14**

Added PRIVFAC a new CAIN_KEY_TYPE USERID_SELECTOR (A60008667).

UCS12

Added FAILURE_OUTCOME, O_ABANDON and O_DISCONNECT messages to the CAINKEY_OPER field (AX1372). Included editorial changes.

CAINKEY (continued)

UCS11

Added FAILURE_OUTCOME, O_ABANDON and O_DISCONNECT messages to the CAINKEY_OPER field (AX1372).

UCS09

Added IN1 value to USERID_SEL and TOLLFREE to the TRIGGER_CRITERIA field (AX1377). Added START value to CAIN_OPER_TYPE field (AX1377).

UCS08

Feature AX0186 adds

- query message O_MID_CALL to subfield CAINKEY_OPER
- the following trigger criteria to subfield TRIGGER_CRITERIA
 - OIECREO
 - NPA_N
 - NPA_NX
 - SIO_STD
 - PRI_STD

Feature AX0187 adds value SPECFEAT to the CAINRESP_TRIGGER_CRITERIA_TYPE of key subfield TRIGGER_CRITERIA.

Feature AX1097 adds

- value TERM_ATT to the CAINRESP_TRIGGER_CRITERIA_TYPE of key subfield TRIGGER_CRITERIA
- value TERMINATION_ATTEMPT to the CAINKEY_OPER_TYPE of the key subfield CAINKEY_OPER

Feature AX0200 adds the value TIMEOUT to the CAINKEY_OPER_TYPE of the key subfield CAINKEY_OPER.

Feature AX0201 adds the trigger criteria OFFHKDEL to the CAINRESP_TRIGGER_CRITERIA_TYPE of key subfield TRIGGER_CRITERIA.

UCS07

Field USERID_SELECTOR is added.

Field USERID_VALUE is expanded to support LNP values.

CAINKEY (end)

Entries SDS_ADIN, CSP_ADIN, SIO_ADIN, LNP_OFCD, NPA, NPA_NXX, NPA_NXXX, NPA_NXXXX, NPA_NXXXXX and EDPREQ are added to the TRIGGER_CRITERIA subfield.

UCS05

Table CAINKEY was created.

CAINMTCH**Table name**

Carrier Advanced Intelligent Network Matching (CAINMTCH) table

Functional description

Table CAINMTCH is used to create an SCP simulator for use in testing Carrier AIN functionality.

Table CAINKEY provides the second level of screening for calls entering the simulator. The CAIN outgoing message content is initially screened in table CAINKEY. The PMI field in table CAINKEY indexes the KEY field of table CAINMTCH. CAIN outgoing message parameters are checked against the datafilled values in table CAINMTCH.

When the outgoing message parameters match the datafilled values, table CAINRESP is indexed and a response is formed and sent to the CAIN framework.

Refer to the *UCS DMS-250 NetworkBuilder Application Guide* for more information on the SCP simulator.

Datafill sequence and implications

Datafill a response in table CAINRESP before datafilling table CAINMTCH.

Table size

0 to 3008 tuples

Memory requirements

Tuples in table CAINMTCH dynamically allocate required memory. The minimum memory allocated is 64 kbytes and the maximum is 3,008 kbytes.

Field descriptions

The following table describes field names, subfield names, and valid data ranges for table CAINMTCH.

Field	Subfield or refinement	Entry	Explanation and action
KEY		0 to 3007	MATCH KEY. Enter an integer for use by table CAINKEY for indexing table CAINMTCH.
PARMS		see subfield	PARAMETERS. Datafill subfield CAINPARM.

CAINMTCH (continued)

Field	Subfield or refinement	Entry	Explanation and action
	CAINPARAM	up to 11 CAINPARAMs	CAIN PARAMETERS. Datafill the CAIN parameters used to determine a match with the CAIN query parameters. Enter up to 11 CAIN parameters.
		ACCESS	Access Code. Enter ACCESS to add an <i>AccessCode</i> parameter to the matching criteria. This field contains an account code. Refer to the CAINPARAM=ACCESS for refinement details.
		CLGNO	Calling Number. Enter CLGNO to add a <i>CallingPartyID</i> parameter to the matching criteria. Refer to the CAINPARAM=CLGNO table for refinement details.
		CLDNO	Called Number. Enter CLDNO to add a <i>CalledPartyID</i> parameter to the matching criteria. Refer to the CAINPARAM=CLDNO table for refinement details.
		CHGNO	Charge Number. Enter CHGNO to add a <i>ChargeNumber</i> parameter to the matching criteria. Refer to the CAINPARAM=CHGNO table for refinement details.
		COLLADDR	Collected Address. Enter COLLADDR to add a <i>CollectAddressInfo</i> parameter to the matching criteria. Refer to the CAINPARAM=COLLADDR table for refinement details.
		COLLDIGS	Collected Digits. Enter COLLDIGS to add a <i>CollectDigits</i> parameter to the matching criteria. This field contains a PIN. Refer to the CAINPARAM=COLLDIGS table for refinement details.
		CARRIER	Carrier. Enter CARRIER to add a <i>Carrier</i> parameter to the matching criteria. This field contains the carrier identification code received on a FGD agency. Refer to the CAINPARAM=CARRIER table for refinement details.

CAINMTCH (continued)

Field	Subfield or refinement	Entry	Explanation and action
		EXTPARM	ExtensionParameter. Enter EXTPARM to add an <i>ExtensionParameter</i> to the matching criteria. Refer to the CAINPARAM=EXTPARM table for refinement details.
		BUSYCSE	BusyCause. Enter BUSYCSE to add a <i>BusyCause</i> parameter to the matching criteria. Refer to the CAINPARAM=BUSYCSE table for refinement details.
		FEATID	Feature Identifier. Enter FEATID to indicate the feature processor used at <i>O_Feature_Requested</i> . Refer to the CAINPARAM=FEATID table for refinement details.
		PIC	Point In Call. Enter PIC to add the <i>PointInCall</i> parameter to the matching criteria. Refer to the CAINPARAM=PIC table for refinement details.
		STRCONN	Send to Resource Connection. Enter STRCONN to add the <i>STRConnection</i> parameter to the matching criteria. Refer to the CAINPARAM=STRCONN table for refinement details.
		VERTSVC	Vertical Service Code. Enter VERTSVC to indicate a vertical service code. Refer to the CAINPARAM=VERTSVC table for refinement details.
		CHGPTYSTN	Charge Party Station Type. Enter CHGPTYSTN to indicate the charge party station type. Refer to the CAINPARAM=CHGPTYSTN table for refinement details.
		LEGID	Call Leg Identification. Enter LEGID to add a <i>LegID</i> parameter to the matching criteria. Refer to the CAINPARAM=LEGID table for refinement details.
		CCID	CcID. Enter CCID to add a <i>CcID</i> parameter to the matching criteria. Refer to the CAINPARAM=CCID table for refinement details.

CAINMTCH (continued)

Field	Subfield or refinement	Entry	Explanation and action
		JIP	Jurisdiction Information Parameter. Enter JIP to add a <i>JurisdictionInformation</i> parameter to the matching criteria and enter a vector of up to 10 digits. Refer to the CAINPARAM=JIP table for refinement details.
		ORIGSTN	Originating Station type. Enter ORIGSTN to add an Originating Station Type parameter to the matching criteria. Refer to the CAINPARAM=ORIGSTN table for refinement details.
		AMP1	AIN MAINTENANCE PARAMETER 1. The presence of and AMP1 parameter is checked for.
		LATA	Local Access and Transport Area. Enter Lata to add a <i>Lata</i> parameter to the matching criteria. Refer to the CAINPARAM=LATA table for refinement details.
		ACCESSTP	ACCESSTP. Datafill with CAIN parameter ACCESSTP to add support for the <i>accessType</i> extension parameter.
ACTION		see subfield	ACTION. This field specifies the action the SCP simulator should take when a match is made. Datafill the MODE subfield
	MODE	RESP, CONV, EDPCONV, IN1	Enter the mode the SCP simulator should enter when a match is made. Enter RESP, CONV, EDPCONV or IN1. See entries following.

The following table describes refinements for the DIGITS field.

Refinement	Subfield or refinement	Entry	Explanation and action
DIGITS		see refinements	Enter nature of address, numbering_plan and digits by datafilling the NATURE_OF_ADDR, NUMBERING_PLAN, and DIGITS subfields.

CAINMTCH (continued)

Refinement	Subfield or refinement	Entry	Explanation and action
	NATURE_OF_ADDR	UNK, NATL, INTL, ACCT, ANI, I2ANI, AUTH, HOTL, MCCS, PIN, VPN, N00, PART, SUBR, NON_UNI_SUBR, NON_UNI_NATL, NON_UNI_INTL, TEST_SUBR_OP, NATL_OP, INTL_OP, NO_NUM_OP, NO_NUM_CT, 950_CT, CLGP_SUBR, CLGP_NOT, CLGP_NATL, CLDP_SUBR, CLDP_NOT, CLDP_NATL, SPR	NATURE OF ADDRESS. Enter a NOA.
	NUMBERING_PLAN	UNK, ISDN, TELE, RSV1, RSV2, PRVT, RSV4, RSV5	NUMBERING PLAN. Enter a numbering plan.
	DIGITS	0 to 24 digits	DIGITS. Enter a vector of up to 24 digits (for example: 1, 2, 3, 4, 5, 6, 7, 8, 9, 0, *, #).

CAINPARAM=CARRIER

When CAINPARAM=CARRIER, datafill the following:

Refinement	Subfield or refinement	Entry	Explanation and action
FOURDIGS		4 digits	FOUR DIGITS. Enter the CIC to match against the query's <i>Carrier</i> parameter. Enter a vector of four digits (for example: N, 1, 2, 3, 4, 5, 6, 7, 8, 9, 0, A, B, C, D, E, F).

CAINMTCH (continued)

CAINPARAM=EXTPARM

When CAINPARAM=EXTPARM, datafill the following:

Refinement	Subfield or refinement	Entry	Explanation and action
PARAM_ID			PARAM_ID. Enter up to 22 parameter values.
		UNIVACC	UNIVERSAL ACCESS. Enter UNIVACC to match against the <code>universalAccess</code> extension parameter. See the DIGITS refinement table for details.
		CONNTIME	Enter CONNTIME to add a <code>connectTime</code> extension parameter to the matching criteria. Datafill the MINUTES refinement.
	MINUTES	Vector of up to 5 characters (0 to 9)	Enter a vector of up to 5 characters. The switch only matches the portion of the extension parameter value containing the number of minutes. It ignores the values for seconds and tenths of seconds. Example: <code>>(EXTPARM CONNTIME 5) \$</code>
		SUBINFO	Enter SUBINFO to add a <code>subscriptionInfo</code> extension parameter to the matching criteria. Enter refinements SUBTYPE and DIGTYPE.
	SUBTYPE	SCP, ADDR, AUTH, ANI, AGENT, OFFICE	Enter subscription type value.
	DIGTYPE	INFO, ADIN, ANI, XLAADDR, ADDR, CIC	Enter digit type value.
		NETINFO	NETWORK INFORMATION. Enter NETINFO to match against the <code>netinfo</code> extension parameter. This parameter and its sub-fields define Multi-switch Business Group information. Datafill the EXTNETID, NETCGID, and NCOS subfields.
	EXTNETID	0 to 32767	Enter the external network identifier.
	NETCGID	0 to 4095	Enter the network customer group identifier.
NCOS	0 to 511	Enter the network class of service identifier.	

CAINMTCH (continued)

Refinement	Subfield or refinement	Entry	Explanation and action
		T1OVFL	T1 Overflow. Enter T1OVFL to match against a <code>t1Overflow</code> extension parameter. This parameter indicates that the query message is an overflow SCP query.
		LNPRCVD	LOCAL NUMBER PORTABILITY RECEIVED. Enter LNPRCVD to match against the <code>lnpReceived</code> extension parameter. This parameter indicates that the SSP received LNP information from a previous switch.
		CAINPRT	Enter CAINPRT to match against the <code>cainPRT</code> extension parameter.
		BILLNUM	BILLING NUMBER. Enter BILLNUM to match against the <code>billingNumber</code> parameter. The Billing Number contains the charge number.
		PINDIGS	PERSONAL IDENTIFICATION NUMBER. Enter PINDIGS to match against the <code>pinDigits</code> extension parameter.
		ACCTCODE	ACCOUNT CODE. Enter ACCTCODE to match against the <code>accountCode</code> extension parameter.
		SWID	SWITCH ID. Enter SWID to match against the <code>switchID</code> extension parameter. Datafill the SWID refinement.
	SWID	0 to 999	Enter a value of 0 to 999.
		UNIVIDX	UNIVERSAL ID TRANSLATION. Enter UNIVIDX to match against the <code>univIdx</code> extension parameter. This parameter indicates what system of Universal Translation will be used by the SSP. Datafill the UNIVIDX refinement.
	UNIVIDX	NIL, AC, PX, CT, FA, OFC, DN, AM, FT, CC, NSC, CTY, NN, or PVN	Enter the abbreviation of the desired system of Universal Translation.
		TREATMENT	TREATMENT. Enter TREATMENT to match against the <code>treatment</code> extension parameter. Datafill the TREATMENT refinement.

CAINMTCH (continued)

Refinement	Subfield or refinement	Entry	Explanation and action
	TREATMENT	0 to 255	Enter a treatment code from 0 to 255.
		TERMTRK	TERMINATING TRUNK INFORMATION. Enter TERMTRK to match against a <code>termTrunkInfo</code> extension parameter. This refinement is used to describe the terminating trunk. Datafill the TRUNKTYPE, TRUNKGROUP, and TRUNKMEMBER subfields.
	TRUNKTYPE	DAL, DAL_TIE, EANT, IMT, FGA, FGB, FGC, AXCESS, or PRI	Enter a trunk type.
	TRUNK-GROUP	0 to 9999	Enter a trunk group.
	TRUNK-MEMBER	0 to 2047	Enter a trunk member.
		ORIGTRK	ORIGINATING TRUNK INFORMATION. Enter ORIGTRK to match against a <code>origTrunkInfo</code> extension parameter. This refinement is used to describe the originating trunk. Datafill the TRUNKTYPE, TRUNKGROUP, and TRUNKMEMBER subfields.
	TRUNKTYPE	DAL, DAL_TIE, EANT, IMT, FGA, FGB, FGC, AXCESS, or PRI	Enter a trunk type.
	TRUNK-GROUP	0 to 9999	Enter a trunk group.
	TRUNK-MEMBER	0 to 2047	Enter a trunk member.
		REORIGCALL	REORIGINATED CALL. Enter REORIGCALL to match against a <code>reorigCall</code> extension parameter.

CAINMTCH (continued)

Refinement	Subfield or refinement	Entry	Explanation and action
		JIP	Jurisdiction Information parameter. Enter JIP to match against the <code>jurisdictionInformation</code> extension parameter. Datafill the JIP refinement.
	JIP	A vector of up to 6 digits	Enter value up to 6 digits.
		NUMREORIG	NUMBER OF REORIGINATIONS. Enter NUMREORIG to match against a <code>numReorig</code> extension parameter.
	NUMREORIG	0 to 255	Enter the number of reoriginations in the range of 0 to 255.
		ADIN	AUTHCODE DATABASE INDEX. Enter ADIN to match against the <code>adin</code> extension parameter. Datafill the ADIN refinement.
	ADIN	0 to 99	Enter a valid authcode database index from authcode tables.
		CAINGRP	CAIN GROUP. Enter CAINGRP to match against the <code>cainGroup</code> extension parameter. Datafill the CAINGRP refinement.
	CAINGRP	0 to 4095	Enter a valid GRPNUM from table CAINGRP.
		BUSYRTE	BUSY ROUTE. Enter BUSYRTE to match against the <code>busyRoute</code> extension parameter. Datafill the NUM_TRIES, AIN_DIGS, and RTE_IDX subfields.
	NUM_TRIES	0 to 99	Enter a number in the range of 0 to 99.
	AIN_DIGS	see explanation	Enter an NOA, numbering_plan, and digits.
	RTE_IDX	A valid key in table CAINUID	ROUTE INDEX. Enter a switch name and CLLI names as datafilled in table CAINUID.
		COLLADDR	Collected Address. Enter COLLADDR to match against the <code>collectedAddress</code> extension parameter. Enter an NOA, numbering_plan, and digits.
	RSV1		This parameter is reserved and cannot be datafilled.

CAINMTCH (continued)**CAINPARAM=BUSYCSE**

When CAINPARAM=BUSYCSE, datafill the following:

Refine-ment	Subfield or refinement	Entry	Explanation and action
BUSYCSE		see refinements	Enter a Busy Cause value.
	CODING_STD	CCITT, INTL, NATL, NETW	
	LOCATION	USER, PRIVATE_LOCAL, PUBLIC_LOCAL, TRANSIT_NET, PUBLIC_REMOTE, PRIVATE_REMOTE, LOCAL_INTERFACE, INTL, UNKNOWN	
	BUSYCSE	valid ISUP cause indicator	

CAINPARAM=FEATID

When CAINPARAM=FEATID, datafill the following:

Refine-ment	Subfield or refinement	Entry	Explanation and action
FEATID		CARD,AUTH,ADR	FEATID. Enter a feature identifier.

CAINMTCH (continued)**CAINPARAM=PIC**

When CAINPARAM=PIC, datafill the following:

Refine-ment	Subfield or refinement	Entry	Explanation and action
PIC		NIL, O_NULL, AUTHORIZE_ORIGINATION _ATTEMPT, COLLECT_INFO RMATION, ANALYZE_INFORMATION, SELECT_ROUTE, AUTHORIZE_CALL_SETUP, SEND_CALL, O_ALERTING, O_ACTIVE, O_SUSPENDED	PIC. Enter a point in call.

CAINPARAM=STRCONN

When CAINPARAM=STRCONN, datafill the following:

Refinement	Subfield or refinement	Entry	Explanation and action
BOOL_ VALUE		Y or N	Enter value Y or N to match against the <i>STRConnection</i> parameter.

CAINPARAM=CHGPTYSTN

When CAINPARAM=CHGPTYSTN, datafill the following:

Refinement	Subfield or refinement	Entry	Explanation and action
CHGPTYSTN		0 to 99	This parameter is based on information from the Originating Line Information parameter at the SSP and indicates the charge party station type.

CAINMTCH (continued)

CAINPARAM=CCID

When CAINPARAM=CCID, datafill the following:

Refinement	Subfield or refinement	Entry	Explanation and action
CCID		Null, OriginatingSetup, stable2Party, terminating Setup, threeParty Setup, threeParty Setup Complement, partyOnHold, partyOnHold Complement, CallWaiting, CallWaiting Complement, stableMParty, transfer, forward	This parameter provides an identifier of a call configuration.

CAINPARAM=JIP

When CAINPARAM=JIP, datafill the following:

Refinement	Subfield or refinement	Entry	Explanation and action
JIP		up to 6 digits	This parameter identifies the call jurisdiction information.

CAINPARAM=LEGID

When CAINPARAM=LEGID, datafill the following:

Refinement	Subfield or refinement	Entry	Explanation and action
LEGID		0-2	This parameter identifies the call leg. 0 indicates the controlling leg (calling party), 1 indicates the first passive leg (called party), and 2 indicates the second passive leg.

CAINMTCH (continued)**MODE=RESP**

When MODE=RESP, datafill the following:

Refinement	Subfield or refinement	Entry	Explanation and action
		RESP	Enter RESP to identify a response should be formed. Datafill the ACTIDX refinement.
	ACTIDX	valid entry in table CAINRESP	Enter an index into table CAINRESP.

MODE=EDPCONV

When MODE=EDPCONV, datafill the following:

Refinement	Subfield or refinement	Entry	Explanation and action
		EDPCONV	EDP Conversation. Enter EDPCONV and datafill the ACTIDX and TIMEOUT refinements to indicate the EDP conversation process.
	ACTIDX	valid entry in table CAINRESP	Enter an index into table CAINRESP.
	TIMEOUT	0 to 31	Enter a value for the response timeout (in minutes).

MODE=CONV

When MODE=CONV, datafill the following:

Refinement	Subfield or refinement	Entry	Explanation and action
		CONV	Conversation. Enter CONV and datafill the RESP_IDX, CONV_IDX, and ERR_ACT refinements.
RESP_IDX			Enter the RESPIDX, TIMEOUT and CLEAR_CAUSES_ALLOWED subfields. Enter up to 4 multiples.

CAINMTCH (continued)

Refinement	Subfield or refinement	Entry	Explanation and action
	RESPIDX	valid entry in table CAINRESP	Enter an index into table CAINRESP.
	TIMEOUT	0-1919	Enter a value for the response timeout (in seconds).
	CLEAR_CAUSES_ALLOWED	vector of up to 5 clear causes allowed	Clear causes allowed. Enter up to five of the following: NORMAL, TIMEOUT, RSRCXLD, UNANSLEG, INVLEG, ABANDON, INVCODE, FAILURE, CHNLSBSY, CLDPANSW, RSRC_NA, ISDNTMO, RSRC_UNK, TASKREF, INVCLRSP, CAPFAIL, PROTOERR, ABORT, SUPPSVC, STRCAN, TEMPFAIL, IPTMO, ORIGCALL, SPLITLEG, MOVELEG, MERGCALL, DISCLEG, SUCCESS, RECONNCT, EDPCOMPL, CTCAN, NIL, ANY. These values cause the playlist to continue. Any other error-type ClearCauses cause the playlist to terminate and cause the switch to perform the error action specified in the tuple. Normal or RSRCXLD are defaults.
CONV_IDX		0-1535	Enter an index into table CAINCONV. This number must be entered as a single number, or as two numbers separated by an underscore.
ERR_ACT		valid tuple in table CAINRESP	Enter a valid key into table CAINRESP to use when an error occurs.

MODE=IN1

When MODE=IN1, datafill the following:

Refinement	Subfield or refinement	Entry	Explanation and action
		IN1	Enter IN1 and datafill the ACTIDX refinement.
	ACTIDX	A valid entry in table IN1RESP	Enter an index into table IN1RESP.

CAINMTCH (continued)**Datafill example**

The following example shows datafill for table CAINMTCH.

```

KEY PARMS ACTION
-----
1 (CLDNO VPN PRVT 2201110) $ RESP
VALIDADDR01

2 (CLDNO VPN PRVT 2201120) $ RESP
VALIDADDR02

3 (CLDNO VPN PRVT 2201130) $ RESP
VALIDADDR03

444 $ IN1 PLAYA3

```

Table history**UCS17**

The table is modified to allow a match on the new value for the ACCESSTP EXTPARM. Also a new EXTPARM subfield, RSV1, is added to the list of extension parameters in this table. (A59034561).

UCS15

Added new parameter, ACCESSTP, to CAINPARAM field. (A60009592).

UCS14

Added new parameter, AMP1, to CAINPARAM field. Added new Nature of Address (NOA), SPR, to the DIGITS field (A60008667).

UCS12

Updated to include editorial changes.

UCS11

Added LATA to the PARMS field (AX1373).

UCS09

Added extension parameters Billing Number, AccountCode, PinDigits and SwitchID (AX0973). Added JIP parameter (AX1098). Updated TIMEOUT subfield under MODE=CONV(AX0974). Added IN1 to the ACTION field (AX1377). The PARMS field was updated to include ORIGSTN (AX1377). TELE replaced the RSV0 value for the numbering plan subfield (AX1377).

CAINMTCH (end)

UCS08

Feature AX0190 expands role of table CAINMTCH to support the Call_Info_To_Resource operation. Updated range of the Key field to allow up to 3008 tuples.

Added the following extension parameters: CallCtrl (AX0201), SubscriptionInfo (AX0190), ConnectTime (AX0200), STRConnectionType (AX0190), PretranslatorName (AX0188), PrimaryTrunkGroupSTS (AX0206), AlternateTrunkGroupSTS (AX0206), Second AlternateTrunkGroupSTS (AX0206), OverflowingRoutingNoSTS (AX0206), NumReorig (AX0186), AmaDigits (AX0190), CainPRT (AX0199), JurisdictionInformation (AX0198), CollectedAddress (BD48466).

Added the following parameters: CcID (AX0186), ClearCauseData (AX0190), DisplayText (AX0197), IPReturnBlock (AX0188), JurisdictionInformation (AX0198), LegID (AX0186).

UCS07

Extension parameters CHGPTYSTN, LNPRCVD, UNIVIDX, NETINFO, and TIOVFL are added.

Mode EDPCONV is added.

UCS05

Table CAINMTCH was created.

CAINPARM

Table name

Carrier Advanced Intelligent Network Parameter (CAINPARM) table.

Functional description

Table CAINPARM contains parameters that affect Carrier Advanced Intelligent Network (CAIN) functionality by providing default values for the entire office where the switch resides.

Note: Table CAINPARM is a parameter table. Tuples cannot be added or deleted.

Refer to the *UCS DMS-250 NetworkBuilder Application Guide* for more information on the CAIN application.

Datafill sequence and implications

Datafill table FLEXTYPE and CAINGRP before table CAINPARM.

Table size

62 parameters

Field descriptions

The following table describes field names, subfield names, and valid data ranges for table CAINPARM.

Field name	Entry	Explanation
PARAMNAME	alphanumeric	<i>Parameter name</i> The parameter names are defined in this section.
PARAMVAL	alphanumeric	<i>Parameter value</i> The parameter values—minimum, maximum, and default—are defined in this section.

ACG_OVERFLOW_GT

This parameter determines the global title to be used in the event that a query is blocked due to an ACG control being encountered.

CAINPARM (continued)

Provisioning Rules

Not Applicable

Range information

The possible values for this parameter are: CAIN_CLID, CAIN_ADDR, CAIN_FEAT {0000 TO 4096}, and NIL.

Minimum	Maximum	Default
Not applicable	Not applicable	NIL

Dump and restore

Not applicable

Activation

Not applicable

ACG_TREATMENT

This parameter determines the treatment to be applied to a call that is blocked by an ACG control when the error action datafilled in the applicable trigger table is set to TREAT.

Note: The error action is taken if the ACG_OVERFLOW_GT is set to NIL or if the query was blocked at the overflow global title.

Provisioning Rules

Not Applicable

Range information

Any valid treatment string of up to 4 characters is entered.

Minimum	Maximum	Default
Not applicable	Not applicable	AINF

Dump and restore

Not applicable

Activation

Not applicable

CAINPARM (continued)**ADDR_GT_FORMAT**

This parameter is used to indicate the type of global title encoding used for the CAIN_ADDR_GT global title type. If the parameter is set to IMPLICIT, a global title indicator of 0010 is used. If the parameter is set to ENHANCED, a global title indicator of 0001 is used.

Provisioning rules

Not applicable

Range information

The possible values for this parameter are IMPLICIT and ENHANCED.

Minimum	Maximum	Default
Not applicable	Not applicable	ENHANCED

Dump and restore rules

Not applicable

Activation

Not applicable

ALLOW_RTTE_TRTMT

This parameter determines whether or not a NetworkBuilder direct termination routed call should get a GNCT treatment or a RTTE treatment when no idle members are available for the terminating trunk. A value of N causes the GNCT treatment with a cause value of NO_CIRCUIT_AVAILABLE. A value of Y causes a RTTE treatment with TERM_RESOURCE_UNAVAILABLE cause value returned to the querying switch.

Provisioning rules

Not applicable

Range information

The possible values for this parameter are: Y or N.

Minimum	Maximum	Default
Not applicable	Not applicable	N

Dump and restore rules

Not applicable

CAINPARM (continued)

Activation

Not applicable

CAIN_CONNECTIONLESS_CLASS

This parameter is used to indicate the type of connectionless class that the DMS will send to the SCCP. If the parameter is set to class0, then a value of zero is sent to the SCCP. If the parameter is set to class1, then a value of one is sent to the SCCP.

Provisioning rules

Not applicable

Range information

The possible values for this parameter are

Possible values	Default
CLASS0, CLASS1	CLASS0

Dump and restore rules

Not applicable

Activation

Not applicable

CAIN_CONVERSATION_LIMIT

This parameter defines the maximum number of conversational messages allowed before sending the call to treatment.

Provisioning rules

None

Range information

The possible values for this parameter are

Minimum	Maximum	Default
0	15	5

Dump and restore rules

Copy the existing value of this parameter or consult Nortel Networks Customer Engineering.

CAINPARM (continued)**Activation**

Immediate

CAIN_DEFAULT_GT

This parameter defines the global title value used when the GT option is not datafilled in the trigger table.

Provisioning rules

None

Range information

The possible values for this parameter are: CAIN_CLID, CAIN_ADDR, or CAIN_FEAT {0 to 4095}

Minimum	Maximum	Default
Not applicable	Not applicable	CAIN_CLID

Dump and restore rules

Copy the existing value of this parameter or consult Nortel Customer Engineering.

Activation

Immediate

CAIN_DEFAULT_OVERFLOW_GT

This parameter defines the default SCP to be used for overflow queries. It is used when the overflow SCP trigger table option is not datafilled for a call.

Provisioning rules

Not applicable

Range information

The possible values for this parameter are: CAIN_CLID, CAIN_ADDR, CAIN_FEAT {0000 TO 4095}, and NIL.

Minimum	Maximum	Default
Not applicable	Not applicable	NIL

Dump and restore rules

Not applicable

CAINPARM (continued)

Activation

Not applicable

CAIN_OFFICE_GROUP

This parameter is used to define a default CAIN group for office-wide subscription.

Provisioning rules

None

Range information

The possible values for this parameter are the defined CAIN groups datafilled in table CAINGRP.

Minimum	Maximum	Default
Not applicable	Not applicable	NIL_GROUP

Dump and restore rules

Copy the existing value of this parameter or consult Nortel Customer Engineering.

Activation

Immediate

CAIN_PROTOCOL_STREAM

This parameter is used to define a CAIN protocol stream. The CAIN protocol stream controls the set of parameters that are sent for a particular message.

Provisioning rules

None

Range information

The possible values for this parameter are UCS05, UCS06, UCS07, UCS08, UCS09, UCS11.

Minimum	Maximum	Default
Not applicable	Not applicable	UCS05

CAINPARM (continued)**Dump and restore rules**

Copy the existing value of this parameter or consult Nortel Customer Engineering.

Activation

Immediate

CAIN_PROTOCOL_VERSION

This parameter sets the CAIN protocol version used by the switch. The CAIN protocol version controls the way parameters are populated, and has a range of values listed as V0, V1, V2, V3, V4, V5.

Note: Prior to UCS08, the CAIN_PROTOCOL_VERSION parameter included both the stream and the version, such as UCS05_V0. Beginning with UCS08, the stream, which controls the set of parameters that are sent for a particular message, is a separate parameter (CAIN_PROTOCOL_STREAM listed above).

Provisioning rules

None

Range information

The possible values for this parameter are: V0, V1, V2, V3, V4, V5.

Minimum	Maximum	Default
V0	V5	V0

Dump and restore rules

Copy the existing value of this parameter or consult Nortel Customer Engineering.

Activation

Immediate

CAIN_SHF_DIGIT_DURATION

The setting of office parameter CAIN_SHF_DIGIT_DURATION applies to Take Back and Transfer calls for XPMs or SPMs. This parameter sets the minimum time an end user must press the octothorpe key (#) in order to initiate

CAINPARM (continued)

the Take Back and Transfer function. Select range and value of the digit duration through the two-part key of office parameter:

- Part one: CAIN_SHF_DIGIT_DURATION_TOGGLE {SHORT, LONG}
- Part two: CAIN_SHF_DIGIT_DURATION_VALUE {4 TO 30} or {5 to 30}.

Setting part one of the key to LONG instructs the switch to interpret part two of the key as a range of 500 milliseconds to 3000 milliseconds.

Setting part one of the key to SHORT instructs the switch to interpret part two of the key as a range of 40 milliseconds to 300 milliseconds.

CAIN_SHF_DIGIT_DURATION defaults to {LONG 5} which is 500 milliseconds.

Provisioning rules

None

Range information

The possible values for this parameter are

Minimum	Maximum	Default
SHORT 4 or LONG 5	SHORT 30 or LONG 30	LONG 5

Dump and restore rules

An ONP from an earlier release sets the office parameter to the default value.

Activation

Immediate

CAIN_STR_RESET_ALLOWED

This parameter defines the number of times the user can reset dialing during a *Send_To_Resource* digit collection interaction. This parameter is also applicable to *Connect_To_Resource* digit collection when performing inswitch digit collection.

Provisioning rules

None

CAINPARM (continued)**Range information**

The possible values for this parameter are

Minimum	Maximum	Default
0	255	0

Dump and restore rules

Copy the existing value of this parameter or consult Nortel Customer Engineering.

Activation

Immediate

CAIN_T1_TIMEOUT

This parameter defines the amount of time, in seconds, the SCP has to respond to a query before the switch times out.

Provisioning rules

None

Range information

The possible values for this parameter are

Minimum	Maximum	Default
0	30	2

Consequences

Increasing the CAIN_T1_TIMEOUT affects the following resource allocations:

- transaction identifier blocks
- component identifier blocks

CAINPARM (continued)

- message buffers

Note: Refer to table VAMPTRID or the *UCS DMS-250 NetworkBuilder Application Guide* for more information on these resources.

- extension blocks

Note: See parameter NUM_CAIN_EXT_BLOCKS or the *UCS DMS-250 NetworkBuilder Application Guide* for more information on CAIN extension blocks.

Dump and restore rules

Copy the existing value of this parameter or consult Nortel Customer Engineering.

Activation

Immediate

CAIN900_LOGS_ENABLED

This parameter controls the generation of the following CAIN900 logs:

- CAIN900 - generated when the SCP simulator sends a response to the CAIN framework
- CAIN901 - generated when the SCP simulator receives an error or abort message from the CAIN framework
- CAIN902 - generated to identify the current CAIN subscription method when evaluating trigger criteria
- CAIN903 - generated to identify the CAIN group when trigger criteria is met
- CAIN904 - generated to indicate that an ADDR collectible is being overwritten.
- CAIN905 - generated to identify the event, the action to be taken, and the originating trunk group, when a requested event is reached.
- CAIN906 - generated when an OFFCCODE trigger is blocked via the NO_LNP option in table CAINSTS.
- CAIN907- generated when conditions that cause an event to be detected are met but the event is not armed.

Provisioning rules

This parameter consists of an options vector that determines which CAIN900 logs are generated.

CAINPARM (continued)**Range information**

The possible values for this parameter are: 900, 901, 902, 903, 904, 905, 906 and 907.

Minimum	Maximum	Default
Not applicable	Not applicable	(900) (901) \$

Consequences

SCP simulator performance is severely impacted when CAIN900 and CAIN901 logs are enabled.

Dump and restore rules

Copy the existing value of this parameter or consult Nortel Customer Engineering.

Activation

Immediate

CLID_GT_FORMAT

This parameter is used to indicate the type of global title encoding used for the CAIN_CLID_GT global title type. If the parameter is set to IMPLICIT, a global title indicator of 0010 is used. If the parameter is set to ENHANCED, a global title indicator of 0001 is used.

Provisioning rules

Not applicable

Range information

The possible values for this parameter are IMPLICIT and ENHANCED.

Minimum	Maximum	Default
Not applicable	Not applicable	ENHANCED

Consequences

Not applicable

Dump and restore rules

Not applicable

Activation

Not applicable

CAINPARM (continued)**DEFAULT_SNPA**

This parameter sets the default serving numbering plan area value used by the switch in parameter population and global title translations.

Provisioning rules

None

Range information

The possible values for this parameter are

Minimum	Maximum	Default
000	999	214

Consequences

Not applicable

Dump and restore rules

Copy the existing value of this parameter or consult Nortel Customer Engineering.

Activation

Immediate

EANT_DEFAULT_ROUTE

This parameter provides default routing as the result of an error or Automatic Call Gapping (ACG) control encountered at the Offhook_Delay (OHD) Trigger at the Info_Collected TDP for calls originating from FGD trunks. If the parameter is set to Y and the errAct field of Offhook_Delay Trigger is set to route, the call is default routed. If the parameter is set to N, the call is handled per existing functionality.

Provisioning rules

Default Routing is invoked only if EANT_DEFAULT_ROUTE is set to Y.

Range information

The possible values for this parameter are Y and N.

Minimum	Maximum	Default
Not Applicable	Not Applicable	N

CAINPARM (continued)**Consequences**

Not applicable

Dump and restore rules

Included in the ONP for the table.

Activation

Immediate.

ENHANCED_DEF_RTE_FOR_8YY_IA

This parameter is designed for Toll-Free 8YY calls in order to provide default routing capability in response to various error scenarios and network management functions. Calls supported originates from DAL_TIE trunk, triggers at TollFree trigger first, and then at the SPECDIG Trigger, CUSTDP Trigger, or SPECFEAT Trigger at the Info_Analyzed TDP. If the parameter is set to Y and the errAct field in the trigger table is set to ROUTE, the call is default routed. If the parameter is set to N, the call is handled based on pre-existing functionality.

Provisioning rules

Not applicable

Range information

The possible values for this parameter are Y and N.

Minimum	Maximum	Default
Not Applicable	Not Applicable	N

Consequences

Not applicable

Dump and restore rules

Included in the ONP for the table.

Activation

Immediate.

FEAT_GT_FORMAT

This parameter is used to indicate the type of global title encoding used for the CAIN_FEAT_GT global title type. If the parameter is set to IMPLICIT, a global title indicator of 0010 is used. If the parameter is set to ENHANCED, a global title indicator of 0001 is used.

CAINPARM (continued)**Provisioning rules**

Not applicable

Range information

The possible values for this parameter are IMPLICIT and ENHANCED.

Minimum	Maximum	Default
Not applicable	Not applicable	ENHANCED

Consequences

Not applicable

Dump and restore rules

Not applicable

Activation

Not applicable

INFO_ANALYZED_FOR_RLT

The INFOANALYZED_FOR_RLT parameter allows the second leg of the SS7 RLT call the ability to trigger specific queries. When INFOANALYZED_FOR_RLT is set to Y, it triggers OFFCCODE, SPECDIG, SPECFEAT and CUSTDP queries. Otherwise it triggers an OFFCCODE query only.

Provisioning rules

Not applicable.

Range information

The range of values is Y or N. The default value is N.

Minimum	Maximum	Default
Not applicable	Not applicable	N

Consequences

Not applicable

Dump and restore rules

Not applicable

CAINPARM (continued)**Activation**

Not applicable

INTL_XLA_TYPE

This parameter controls the translation of the CalledPartyId and the Overflow Number when the Nature of Address (NOA) is International (INTL).

Provisioning rules

Not applicable

Range information

The possible values for this parameter are IN and IP.

When the default IN value is chosen, the international translation type uses table CCTR to translate the number for routing.

When the IP value is chosen, the international partitioned translation type uses tables CTRTE, CTCODE, CTHEAD, and STS2CCDB to translate the number for routing.

Minimum	Maximum	Default
Not applicable	Not applicable	IN

Consequences

Not applicable

Dump and restore rules

Not applicable

Activation

Not applicable

LNP_4IMT_RLT

This parameter, in combination with the CAIN option in table TRUNKGRP, enables LNP functionality on IMTRLT. This parameter replaces the TRKGRP option LNPRLT. Office parameter LNP_4IMT_RLT will enable or disable all LNP functionality on RLT except RX LNP.

Provisioning rules

Not applicable

CAINPARAM (continued)**Range information**

The possible values for this are Y, N.

Minimum	Maximum	Default
Not applicable	Not applicable	N

Consequences

Not applicable

Dump and restore rules

Patch TDR23 conditions:

- Where patch TDR23 is active in a previous load, transfer the LNP_4IMT_RLT CAIN parameter to the current load as is.
- Where patch TDR23 is applied or absent and the LNPRT option is datafilled on any IMT trunk in table TRKGRP, setLNP_4IMT_RLT to Y.

Activation

Not applicable

LNP_FOR_RX_SELECTOR

This parameter controls examining of a new called number for LNP interactions. If the office parameter, has a value of Y, LNP is supported for a retranslation (RX) call, and the number is evaluated for NetworkBuilder interactions. If the office parameter, has a value of N, there are no LNP interactions on RX calls, and the called number is processed without NetworkBuilder involvement. However, if the called number is changed by the RX Selector, then any previous LNP data is reset.

Provisioning rules

Not applicable

Range information

The possible values for this parameter are Y or N.

Minimum	Maximum	Default
Not applicable	Not applicable	N

Consequences

Not applicable

CAINPARM (continued)**Dump and restore rules**

Not applicable

Activation

Not applicable

LNP_LOGS_ENABLED

This parameter controls generation of the CAIN301 log. This log is generated when a ported number has been misrouted and the RELEASE message returns cause 26.

Provisioning rules

None

Range information

This parameter consists of an options vector that may contain the value 301. The possible values for this parameter are (301) and \$.

Minimum	Maximum	Default
Not applicable	Not applicable	(301) \$

Consequences

Not applicable

Dump and restore rules

Not applicable

Activation

Immediate

LNP_PARAMETER_SET

This parameter indicates what set of parameters will be sent to the SCP in the LNP Info_Analyzed message. COMPLETE_SET sends Userid, BearerCapability, CalledPartyId, TriggerCriteriaType, CallingPartyId, Carrier, ChargeNumber, and ChargePartyStationType. MINIMUM_SET only sends Userid, BearerCapability, CalledPartyId, and TriggerCriteriaType.

Provisioning rules

None

CAINPARM (continued)**Range information**

The possible values for this parameter are COMPLETE_SET and MINIMUM_SET.

Minimum	Maximum	Default
Not applicable	Not applicable	COMPLETE_SET

Consequences

Not applicable

Dump and restore rules

Copy the existing value of this parameter or consult Nortel Customer Engineering.

Activation

Immediate

LNP_PROTOCOL_STREAM

This parameter controls the LNP protocol. If set to UCS07, then only the CLDNO parameter should be returned to OFFCODE queries. When set to UCS08, the FCI parameter with bit M, GENADDR parameter containing a PORTEDNO and a CLDNO parameter must be returned in response to interpret the CLDNO as an LRN.

Provisioning rules

Not applicable

Range information

Only one version of the LNP protocol exists.

Minimum	Maximum	Default
Not applicable	Not applicable	UCS07

Consequences

Not applicable

Dump and Restore

Not applicable

Activation

Not applicable

CAINPARM (continued)**LNP_PROTOCOL_VERSION**

This parameter determines the protocol under which the LNP Analyze_Route is processed. It also controls which LNP specific parameters are used by the service switching point (SSP). The version control applies to the FCI and LNP GAP parameters returned in an Analyze_Route message in response to an LNP query. This parameter does not affect processing of the FCI or the LNP GAP parameters returned in an Analyze_Route message in response to a CAIN query.

The LNP_PROTOCOL_VERSION also controls whether the JIP parameter is built into outgoing CAIN query messages.

Provisioning rules

Not applicable

Range information

The possible value for this parameter is V1.

Minimum	Maximum	Default
Not applicable	Not applicable	V1

Consequences

Not applicable

Dump and restore rules

Not applicable

Activation

Immediate

MATCH_TERMTRK_CLLI

When this parameter is set to MATCH, the TERMTRK field in table TERMTRTE must match the ADNUM field in table CLLI for the terminating trunk. By matching, only one route can be defined and is limited to the datafill in table CLLI.

When this parameter is set to NOMATCH, the TERMTRK field is unrelated to the ADNUM field. By not matching table CLLI, multiple route definition is allowed. Therefore, the SCP needs no knowledge of table CLLI.

Provisioning rules

None

CAINPARAM (continued)

Range information

The possible values for this parameter are MATCH or NOMATCH.

Minimum	Maximum	Default
Not applicable	Not applicable	MATCH

Consequences

Not applicable

Dump and restore rules

Copy the existing value of this parameter or consult Nortel Customer Engineering.

Activation

Immediate

MAX_FAILURE_OUTCOMES

This parameter controls the number of Failure_Outcome messages that may be sent in a single transaction to the SCP.

Provisioning rules

None

Range information

The possible values for this parameter are:

Minimum	Maximum	Default
0	3	2

Consequences

Not applicable.

Dump and restore

Not applicable.

Activation

Immediate

CAINPARM (continued)**MAX_NUM_SERIAL_TRIGGERS**

This parameter contains the maximum number of serial triggers including TDP-Requests (queries) and EDP-Requests allowed for a call. In other words, the maximum number of times a single call can be sent to the SCP.

Provisioning rules

None

Range information

The possible values for this parameter are:

Minimum	Maximum	Default
0	10	3

Activation

Immediate

Consequences

Not applicable

Dump and restore rules

Copy the existing value of this parameter or consult Nortel Customer Engineering.

NB_ROUTING_ANNC_ID

NB_ROUTING_ANNC_ID parameter specifies an announcement_ID value that generates a CAIN303 log. When the switch receives a Send to Resource Message with the STR parameter block announcement_ID value set to a value specified by the NB_ROUTING_ANNC_ID parameter the CAIN303 log is generated.

Note that the CAIN303 log will only be generated if the NB_ROUTING_LOG CAINPARM is set to Y.

Provisioning rules

None.

CAINPARM (continued)

Range information

The possible values for this parameter are:

Minimum	Maximum	Default
0	4095	4095

Consequences

Not applicable

Dump and restore rules

NB_ROUTING_LOG parameter is set to Y when patch KMP18 is active in a previous load.

Activation

Immediate

NB_ROUTING_LOG

NB_ROUTING_LOG parameter controls whether the CAIN303 log is generated.

Provisioning rules

None.

Range information

The possible values for this parameter are:

Minimum	Maximum	Default
N	Y	N

Consequences

Not applicable

Dump and restore rules

NB_ROUTING_LOG parameter is set to Y when patch KMP18 is active in a previous load.

Activation

Immediate

CAINPARM (continued)**NUM_CAIN_ECCBS**

This parameter allocates pools of extended call condense blocks (ECCBS) for CAIN call processing. These extended call condense blocks store CAIN call data from the origination of a call until the originator is released.

Provisioning rules

The switch requires extended call condense blocks in order to query the SCP. These blocks are allocated as a percentage of the NCCBS office parameter in table OFCENG.

Range information

The possible values for this parameter (UCS-DMS 250 application) are:

Minimum	Maximum	Default
0	65535	260

Note: The information in the following table is only applicable to Nortel Networks Succession products.

The possible values for this parameter (Succession Call Server application) are:

Minimum	Maximum	Default
0	131072	260

Consequences

Not applicable

Dump and restore rules

Copy the existing value of this parameter or consult Nortel Customer Engineering.

Activation

Immediate

NUM_CAIN_EXT_BLOCKS

This parameter contains the number of extension blocks available to CAIN call processing.

Provisioning rules

None

CAINPARM (continued)

Range information

The possible values for this parameter (UCS-DMS 250 application) are:

Minimum	Maximum	Default
0	32767	260

Note: The information in the following table is only applicable to Nortel Networks Succession products.

The possible values for this parameter (Succession Call Server application) are:

Minimum	Maximum	Default
0	65535	260

Consequences

Not applicable

Memory requirements

This parameter requires 292 words of memory for each allocated extension block.

Dump and restore rules

Copy the existing value of this parameter or consult Nortel Customer Engineering.

Activation

Immediate

NUM_FRAMEWORK_EXT_BLOCKS

This parameter controls the number of Framework extension blocks allocated on the switch. Each allocated extension block requires 292 words. One extension block is required for each simultaneous CAIN query.

Provisioning rules

None

CAINPARM (continued)**Range information**

The possible values for this parameter(UCS-DMS 250 application) are:

Minimum	Maximum	Default
0	32767	1800

Note: The information in the following table is only applicable to Nortel Networks Succession products.

The possible values for this parameter (Succession Call Server application) are:

Minimum	Maximum	Default
0	65535	1800

Consequences

Not applicable

Memory requirements

This parameter requires 140 words of memory for each allocated extension block.

Dump and restore rules

Copy the existing value of this parameter or consult Nortel Networks Customer Engineering.

Activation

Immediate

NUM_FURNISHAMA_EXT_BLOCKS

NUM_FRNISHAMA_EXT_BLOCKS is the number of CAIN furnish AMA extension blocks to be allocated.

Provisioning rules

None

CAINPARM (continued)**Range information**

The possible values for this parameter (UCS-DMS 250 application) are:

Minimum	Maximum	Default
0	32767	0

Note: The information in the following table is only applicable to Nortel Networks Succession products.

The possible values for this parameter (Succession Call Server) are:

Minimum	Maximum	Default
0	67000	0

Consequences

No consequences.

Memory requirements

No memory requirements.

Dump and restore rules

Not applicable

Activation

A cold restart is needed subsequent to decreasing the parameter size.

NUM_SEND_NOTIFICATION_EXT_BLOCKS

This parameter controls the number of Send Notification extension blocks the switch has available.

Provisioning rules

None

Range information

The possible values for this parameter(UCS-DMS 250 application) are:

Minimum	Maximum	Default
0	32767	0

CAINPARM (continued)

Note: The information in the following table is only applicable to Nortel Networks Succession products.

The possible values for this parameter (Succession Call Server) are:

Minimum	Maximum	Default
0	65535	0

Consequences

The Termination notification functionality is not allowed if the parameter is:

- Missing
- Never increased from the defaulted value
- Does not have an available SN extension block inside the extension block pool.

Memory requirements

This parameter requires 38 words of memory for each extension block.

Dump and restore rules

Not applicable

Activation

Immediate

NUM_STR_EXT_BLOCKS

This parameter controls the number of *Send_To_Resource* (STR) extension blocks needed for managing the connection to an SSP resource. The STR extension block is used when a *Send_To_Resource* or *Connect_To_Resource* message is received.

Provisioning rules

The switch requires CAIN STR extension blocks for *Send_To_Resource* or *Connect_To_Resource* conversational processing. Changes to the parameter take effect after a Cold Restart.

Range information

The possible values for this parameter(UCS-DMS 250 application) are:

Minimum	Maximum	Default
0	32767	260

CAINPARM (continued)

Note: The information in the following table is only applicable to Nortel Networks Succession products.

The possible values for this parameter (Succession Call Server) are:

Minimum	Maximum	Default
0	65535	260

Consequences

Not applicable

Memory requirements

This parameter requires 102 words of memory for each allocated extension block.

Dump and restore rules

Copy the existing value of this parameter or consult Nortel Customer Engineering.

Activation

Immediate

NUM_T_CAIN_EXT_BLOCKS

This parameter indicates the number of terminating call model extension blocks that are allowed for the switch.

Provisioning rules

When provisioning NUM_T_CAIN_EXT_BLOCKS, consider the potential impact of allocating multiple extension blocks per call: one for the originating call model, and one for the terminating call model.

Range information

The possible values for this parameter (UCS-DMS 250 Application) are:

Minimum	Maximum	Default
0	32767	260

Note: The information in the following table is only applicable to Nortel Networks Succession products.

CAINPARM (continued)

The possible values for this parameter (Succession Call Server) are:

Minimum	Maximum	Default
0	65535	260

Consequences

Not applicable

Memory requirements

This parameter requires 290 words of memory for each allocated extension block.

Dump and restore rules

Copy the existing value of this parameter or consult Nortel Customer Engineering.

Activation

Immediate

O_NO_ANSWER_TIMER

This parameter defines the time, in seconds, the switch should wait for a call to answer before activating the *O_No_Answer* trigger or event. This parameter is only used when no *ONoAnswerTime* parameter was received in a *Request_Report_BCM_Event* component and the OANSTIME option is not datafilled for the CAIN group.

Provisioning rules

None

Range information

The possible values for this parameter are:

Minimum	Maximum	Default
1	120	18

Consequences

Not applicable

Memory requirements

Not applicable

CAINPARM (continued)

Dump and restore rules

Copy the existing value of this parameter or consult Nortel Customer Engineering.

Activation

Immediate

OFCD_GT_FORMAT

This parameter is used to indicate the type of global title encoding used for the CAIN_OFCD_GT global title type. If the parameter is set to IMPLICIT, a global title indicator of 0010 is used. If the parameter is set to ENHANCED, a global title indicator of 0001 is used.

Provisioning rules

Not applicable

Range information

The possible values for this parameter are IMPLICIT and ENHANCED.

Minimum	Maximum	Default
Not applicable	Not applicable	ENHANCED

Consequences

Not applicable

Memory requirements

Not applicable

Dump and restore rules

Not applicable

Activation

Not applicable

OFFKDEL_TRIG_AFTER_TREAT

This parameter is used to determine if the switch will be allowed to evaluate the *Off_Hook_Delay* trigger when CAIN detects a treatment has been set by in-switch screening.

Provisioning rules

Not applicable

CAINPARM (continued)

Range information

The possible values for this parameter are ALLOWED and DISALLOWED.

Minimum	Maximum	Default
DISALLOWED	ALLOWED	ALLOWED

Consequences

Not applicable

Memory requirements

Not applicable

Dump and restore rules

Not applicable

Activation

Not applicable

OFTRREQ_FLEXTYPE_MAP

This parameter provides a method to store the digits collected by the *O_Feature_Requested* trigger and FLEXDIAL for later retrieval by both CAIN and FLEXDIAL

Provisioning rules

None

Range information

This parameter is datafilled as an option vector of four mappings. Each option identifies the mapping from a given *O_Feature_Requested* digit collectible to its corresponding FLEXTYPE tuple. The following options can be provisioned:

- (PIN <table FLEXTYPE index>)
- (CARD <table FLEXTYPE index>)
- (AUTH <table FLEXTYPE index>)
- (ACCT <table FLEXTYPE index>)

Note: Since this option vector is implemented as a CAIN office parameter, all options must be datafilled on the same line of input. As with any option vector, a \$ character is used to signify the end of input.

CAINPARM (continued)

The possible values for this parameter are listed above.

Minimum	Maximum	Default
Not Applicable	Not Applicable	\$

Dependencies

Table FLEXTYPE must be datafilled previous to setting OFTRREQ_FLEXTYPE_MAP values.

Consequences

Not applicable

Memory requirements

This parameter requires 4 words of memory.

Dump and restore rules

This parameter is restored as datafilled.

Activation

Immediate

PRIVATE_FACILITY_GROUP_USERID

Parameter *Private_Facility_Group_UserID* allows the “Private facility” encoding of parameter *UserID* (for originating DAL trunks only).

A value of “N” indicates that UserID is set to the same value that was sent in the Info_Collected message. A value of “Y” indicates that the *UserID* parameter contains the incoming DAL *PrivateFacilityGID* from ADNUM field of Table CLLI with “Private Facility” encoding for DAL origination trunks only. Prior functionality exists otherwise.

Provisioning rules

Not applicable

Range information

The possible values for this parameter are:

Minimum	Maximum	Default
Y	N	N

CAINPARM (continued)

Dependencies

Not applicable

Consequences

Not applicable

Dump and restore rules

Unchanged

Activation

Immediate

RESTRICT_NETBUSY_BUSYCAUSE

Parameter *Restrict_NetBusy_BusyCause* is added to allow a control mechanism for restricting the delivery of *BusyCause* parameter.

When the value is set to “N”, the *BusyCause* parameter will be include in the *Network_Busy* message and when the value is set to “Y” parameter *BusyCause* will not be sent.

Provisioning rules

Not applicable

Range information

The possible values for this parameter are:

Minimum	Maximum	Default
Y	N	N

Dependencies

Not applicable

Consequences

Not applicable

Dump and restore rules

Unchanged

Activation

Immediate

CAINPARM (continued)

RSVD1

This parameter is reserved for future use. No functionality is provided by this parameter.

Provisioning rules

None

Range information

The possible values for this parameter are:

Minimum	Maximum	Default
0	31	10

Dependencies

Not applicable

Consequences

Not applicable

Dump and restore rules

Not applicable

Activation

Not applicable

RSVD2

This parameter is reserved for future use. No functionality is provided by this parameter.

Provisioning rules

None

Range information

The possible values for this parameter are:

Minimum	Maximum	Default
0	255	48

Dependencies

Not applicable

CAINPARM (continued)**Consequences**

Not applicable

Dump and restore rules

Not applicable

Activation

Not applicable

SEND_CARRIER_FROM_TRKGRP

When this parameter is set to Y, the default CIC can be used as part of the TCAP query message.

Note: In UCS08 the name of this parameter was changed from SEND_CARRIER_FROM_TRKGRP1 because the default CIC value is now retrieved from Table TRKGRP instead of Table TRKGRP1.

Provisioning rules

None

Range information

The possible values for this parameter are Y or N.

Minimum	Maximum	Default
Not applicable	Not applicable	N

Dependencies

Not applicable

Consequences

Not applicable

Dump and restore rules

The SEND_CARRIER_FROM_TRKGRP parameter is added, and the value from SEND_CARRIER_FROM_TRKGRP1 is copied to this field during the 07 to 08 ONP.

Activation

Immediate

CAINPARM (continued)

SEND_SPECIAL_AA

This parameter is created to control the sending of the new InfoCollected assignment authority, with its contents (the accessType extension parameter) to the SCP. This parameter also controls the transmission of the InfoCollected ExtensionAa.

Provisioning rules

The new InfoCollected assignment authority is sent to the SCP if and only if SEND_SPECIAL_AA is set to Y. When SEND_SPECIAL_AA is set to Y, the Info Analyzed assignment authority family is set.

Range information

The possible values for this parameter are Y and N.

Minimum	Maximum	Default
Y	N	N

Consequences

If this parameter is set to Y, the InfoCollected assignment authority will be used, not the Nortel DMS-250 family extension parameters.

Dump and restore rules

Included in the ONP for the table.

Activation

Immediate.

STANDARD_ANISCREEN_RULES

This parameter allows the option to only screen an incoming ANI for a CAIN subscription via tables ANISCUSP and ANIVAL when the screening is provided for all other services.

ANI is normally screened only when the incoming trunk group type is either EANT or PRA250, and the ANIBYP option is not used (on EANT) or the CLIDBYP option is not used (on PRA250).

Provisioning rules

Not applicable

CAINPARM (continued)**Range information**

The possible values for this parameter are Y and N.

Minimum	Maximum	Default
Not applicable	Not applicable	N

Consequences

If this parameter is set to Y, only EANT or PRA250 originations screen for CAIN subscription based upon ANI when the ANIBYP or CLIDBYP options are not provisioned in tables CICROUTE or CALLATTR, respectively.

When this parameter is set to N, screening for CAIN subscription based upon ANI is performed on all calls, regardless of the type of incoming trunk or the value of ANIBYP or CLIBYP.

Dump and restore rules

Included in the ONP for the table.

Activation

Immediate.

STR_CONNECTION_TYPE

This parameter defines the connection between the intelligent peripheral (IP) and switching control point (SCP).

Provisioning rules

None

Range information

The possible values for this parameter are: NONE, CONNECT_ONLY, or CONNECT_1129_STYLE.

Minimum	Maximum	Default
Not applicable	Not applicable	NONE

Dependencies

Not applicable

Consequences

Not applicable

CAINPARAM (continued)

Memory requirements

Not applicable

Dump and restore rules

Copy the existing value of this parameter or consult Nortel Customer Engineering.

Activation

Immediate

TDISC_TIMER

This parameter determines the maximum time duration in seconds, in which the Intelligent Peripheral (IP) must respond to a FACILITY message with the cancelIPResource operation.

Provisioning rules

Not applicable

Range information

The possible values for this parameter are (in seconds):

Minimum	Maximum	Default
1	4	4

Dependencies

Not applicable

Consequences

Not applicable

Memory requirements

Not applicable

Dump and restore rules

Not applicable

Activation

Immediate

TERM_NOTIF_BUSY_CSE_IND

This parameter is created to control the setting of the BusyCauseInd flag in the Termination Notification message sent to the SCP.

CAINPARM (continued)**Provisioning rules**

If the TERM_NOTIF_BUSY_CSE_IND is “NET_AND_USER_BUSY”, then the BusyCauseInd flag of the Termination Notification message sent to the SCP will be set in instances of both Network Busy and User Busy.

If the TERM_NOTIF_BUSY_CSE_IND is “NET_BUSY_ONLY”, then the BusyCauseInd flag of the Termination Notification message sent to the SCP will be set in instances of Network Busy only. The BusyCauseInd flag will not be set for instances of User Busy.

Range information

The possible values for this parameter are NET_AND_USER_BUSY or NET_BUSY_ONLY.

Minimum	Maximum	Default
NET_AND_USER_BUSY	NET_BUSY_ONLY	NET_AND_USER_BUSY

Consequences

Not applicable

Dump and restore rules

Included in the ONP for the table.

Activation

Immediate.

TIMEOUT_TIMER

This parameter specifies in minutes, how long a call can be active before encountering the timeout event. The TIMEOUT_TIMER parameter is used when the Service Control Point (SCP) requests that the timeout event be reported but provides no TIMEOUT_TIMER parameter or an invalid value. The Timeout event is detected at the O_Mid_Call EDP when the TimeoutTimer expires before the calling party is disconnected from the called party. The TimeoutTimer can be re-started if the Timeout event is requested again after the Service Switching Point (SSP) sends a CTR_Clear message at the O_Mid_Call EDP.

Provisioning rules

Not applicable

CAINPARM (continued)**Range information**

The possible values for this parameter are in the range of 0 to 180 (in minutes):

Minimum	Maximum	Default
1	180	30

Dependencies

Not applicable

Consequences

Not applicable

Memory requirements

Not applicable

Dump and restore rules

Not applicable

Activation

Immediate

TRTMTCD_COMPCODE_ZAPPED_ZERO

This parameter is added to provide an optionality to zap the TRTMTCD and COMPCODE fields in the CDR for calls terminated by the DISCONNECT message.

Provisioning rules

When the value is set to "N", the TRTMTCD and COMPCODE fields in the CDR are populated with appropriate values, depending on the treatment set and the type of call completion for calls terminated by the DISCONNECT message.

When the value is set to "Y", these CDR fields are zapped to Zero for calls terminated by the DISCONNECT message.

Range information

The possible values for this parameter are Y or N.

Minimum	Maximum	Default
Y	N	N

CAINPARM (continued)**Dependencies**

Not applicable

Consequences

Not applicable

Memory requirements

Not applicable

Dump and restore rules

Included in the ONP for the table.

Activation

Immediate

TSTRC_TIMER

This parameter determines the maximum time duration (in minutes), of the STR-Connection

Provisioning rules

Not applicable

Range information

The possible values for this parameter are in the range of 0 to 60 (in minutes):

Minimum	Maximum	Default
0	60	6

Dependencies

Not applicable

Consequences

Not applicable

Memory requirements

Not applicable

Dump and restore rules

Not applicable

Activation

Immediate

CAINPARM (continued)

Datavill example

The following example shows datavill for table CAINPARM.

```
PARMNAME PARMVAL  
  
ACG_OVERFLOW_GT NIL  
ACG_TREATMENT AINF  
ADDR_GT_FORMAT ENHANCED  
ALLOW_RTTE_TRTMT N  
CAIN_CONVERSATION_LIMIT 5  
CAIN_DEFAULT_GT CAIN_CLID  
CAIN_DEFAULT_OVERFLOW_GT NIL  
CAIN_OFFICE_GROUP NIL_GROUP  
CAIN_PROTOCOL_STREAM UCS05  
CAIN_PROTOCOL_VERSION V0  
CAIN_SHF_DIGIT_DURATION LONG 5  
CAIN_STR_RESET_ALLOWED 0  
CAIN_T1_TIMEOUT 2  
CAIN900_LOGS_ENABLED (900) (901) $  
CLID_GT_FORMAT ENHANCED  
RSVD1 10  
RSVD2 48  
DEFAULT_SNPA 214  
EANT_DEFAULT_ROUTE N  
ENHANCED_DEF_RTE_FOR_8YY_IA N  
FEAT_GT_FORMAT ENHANCED  
INFOANALYZED_FOR_RLT N  
INTL_XLA_TYPE IN  
LNP_4IMT_RLT N  
LNP_FOR_RX_SELECTOR N  
LNP_LOGS_ENABLED (301) $  
LNP_PARAMETER_SET COMPLETE_SET  
LNP_PROTOCOL_STREAM UCS07  
LNP_PROTOCOL_VERSION V1  
MATCH_TERMRTE_CLLI MATCH
```

CAINPARAM (continued)

```

PARMNAME PARMVAL

MAX_FAILURE_OUTCOMES 2
MAX_NUM_SERIAL_TRIGGERS 3
NB_ROUTING_ANNC_ID 4095
NB_ROUTING_LOG N
NUM_CAIN_ECCBS 260
NUM_CAIN_EXT_BLOCKS 260
NUM_FRAMEWORK_EXT_BLOCKS 1800
NUM_FURNISHAMA_EXT_BLOCKS 0
NUM_SEND_NOTIFICATION_EXT_BLOCKS 0
NUM_STR_EXT_BLOCKS 260
NUM_T_CAIN_EXT_BLOCKS 260
O_NO_ANSWER_TIMER 18
OFCD_GT_FORMAT ENHANCED
OFFHKDEL_TRIG_AFTER_TREAT ALLOWED
OFTRREQ_FLEXTYPE_MAP $
PRIVATE_FACILITY_GROUP_USERID N
RESTRICT_NETBUSY_BUSYCAUSE N
SEND_CARRIER_FROM_TRKGRP N
SEND_SPECIAL_AA N
STANDARD_ANISCREEN_RULES N
STR_CONNECTION_TYPE NONE
TDISC_TIMER 4
TERM_NOTIF_BUSY_CSE_IND NET_AND_USER_BUSY
TIMEOUT_TIMER 30
TRTMTCD_COMPCODE_ZAPPED_ZERO N
TSTRC_TIMER 6

```

Table history**SN07 (DMS)**

Added parameter TRTMTCD_COMPCODE_ZAPPED_ZERO per CR Q00816405.

Added parameter STANDARD_ANISCREEN_RULES per CR Q00909834-01.

SN06 (DMS)

Added parameter CAIN_CONNECTIONLESS_CLASS per CR Q00652974-02.

UCS17

The Info Analyzed CAIN message is enhanced with a new assignment authority/extension parameter and augmenting support for default routing of calls incurring a failed 8YY query, (A59033997).

CAINPARM (continued)

UCS15

Made Datafill example a text box for easier modification purposes. Added parameter EANT_DEFAULT_ROUTE. Expanded table size to 54 parameters (A60009562). Added parameters SEND_SPECIAL_AA and TERM_NOTIF_BUSY_CSE_IND (60009571). Added parameter ENHANCED_DEF_RTE_FOR_8YY_IA (A60009589).

UCS14

Added parameters RSVD1 and RSVD2. These parameters are reserved for future use (A60008664). Added parameters PRIVATE_FACILITY_GROUP_USERID and RESTRICT_NETBUSY_BUSYCAUSE (A60008691). Added parameter OFFHKDEL_TRIG_AFTER_TREAT (A6008693). Added range capacity information to office parms for Nortel Networks Succession product. Office parms changed include: NUM_CAIN_ECCBS, NUM_CAIN_EXT_BLOCKS, NUM_FRAMEWORK_EXT_BLOCKS, NUM_SEND_NOTIFICATION_EXT_BLOCK, NUM_STR_EXT_BLOCKS, NUM_T_CAIN_EXT_BLOCKS, NUM_FURNISHAMA_EXT_BLOCKS. This information is only applicable for Succession products. (A60008541).

UCS13

Added CAIN_STR_RESET_ALLOWED parameter (AT60007655) for NetworkBuilder Short duration tone detection on take back and transfer feature. Added new parameters NB_ROUTING_ANNC_ID and NB_ROUTING_LOG (SR60089576). Added new parameter NUM_FURNISHAMA_EXT_BLOCKS (A60008243).

UCS12

Added LNP_4IMT_RLT parameter(PSD08007). Updated maximum value for parameter NUM_CAIN_ECCBS.

UCS11

Added MAX_FAILURE_OUTCOMES parameter (AX1372). Changed parameter CAIN900_LOGS_ENABLED to a vector of 8 log types (900, 901, 902, 903, 904, 905, 906, 907). 907 included as a new option (AX1372). Added values V5 to CAIN_PROTOCOL_VERSION and UCS11 to CAIN_PROTOCOL_STREAM (AX1373).

UCS09

Added parameters ACG_OVERFLOW_GT and ACG_TREATMENT (AX0198, AX0976). Added parameter INFOANALYZED_FOR_RLT (PSD07021). Added parameter NUM_SEND_NOTIFICATION_EXT_BLOCKS (AX0972). Updated

CAINPARM (continued)

parameters LNP_PROTOCOL_VERSION, LNP_PROTOCOL_STREAM (AX0973, AX0198). Updated LNP_LOGS_ENABLED (AX0973, AX0198).

UCS08

Added the following parameters:

- ADDR_GT_FORMAT
- CAIN_PROTOCOL_STREAM
- CLID_GT_FORMAT
- FEAT_GT_FORMAT
- INTL_XLA_TYPE
- LNP_FOR_RX_SELECTOR
- LNP_LOGS_ENABLED
- LNP_PROTOCOL_VERSION
- NUM_T_CAIN_EXT_BLOCKS
- OFCD_GT_FORMAT
- SEND_CARRIER_FROM_TRKGRP
- TDISC_TIMER
- TIMEOUT_TIMER
- TSTRC_TIMER

Divided parameter CAIN_PROTOCOL_VERSION into two separate parameters: CAIN_PROTOCOL_STREAM and CAIN_PROTOCOL_VERSION.

Changed parameter SEND_CARRIER_FROM_TRKGRP1 to SEND_CARRIER_FROM_TRKGRP.

Changed parameter CAIN900_LOGS_ENABLED to a vector of 7 log types (900, 901, 902, 903, 904, 905, 906). Added new value 906 as an option.

UCS07

Added the following parameters:

- CAIN_DEFAULT_OVERFLOW_GT
- NUM_CAIN_EXT_BLOCKS
- LNP_PARAMETER_SET
- ALLOW_RTTE_TRTMT

CAINPARM (end)

UCS07 templates added to CAIN_PROTOCOL_VERSION.

UCS06

Added the following parameters:

- CAIN_CONVERSATION_LIMIT
- CAIN_DEFAULT_GT
- CAIN_PROTOCOL_VERSION
- CAIN_STR_RESET_ALLOWED
- DEFAULT_SNPA
- NUM_FRAMEWORK_EXT_BLOCKS
- O_NO_ANSWER_TIMER
- SEND_CARRIER_FROM_TRKGRP1
- STR_CONNECTION_TYPE
- OFTREQ_FLEXTYPE_MAP

Changed parameter CAIN900_LOGS_ENABLED to allow generation of none, individual, or combinations of the CAIN900 log series.

UCS05

Created Table CAINPARM.

CAINPRT

Table name

Carrier Advanced Intelligent Network (AIN) Pretranslator (CAINPRT)

Functional description

Table CAINPRT contains the definitions of the entities collected by the switch at run-time (determined by the digits the user dials), called collectibles. Associated with each tuple is the digit range that the subscriber must dial to "match" on this tuple. Once the subscriber has matched on a tuple, the switch collects the remaining digits, if any. The switch can also specify additional *O_Feature_Requested* collectibles. After the switch collects these, the user can specify another CAINPRT tuple.

If, in the processing of CAINPRT collectibles, the switch encounters duplicate collectibles of the same type, the most recently processed collectible overwrites the previous one. The switch generates a CAIN904 log.

Datafill sequence and implications

Datafill table CNPRTNUM before table CAINPRT.

Datafill table OFTRREQ after table CAINPRT.

Table size

0 to 12288 tuples

Field Descriptions

The following table describes field names, subfield names, and valid data ranges for table CAINPRT.

CAINPRT Field descriptions (Sheet 1 of 4)

Field	Subfield or refinement	Entry	Explanation and action
CAINPRTKEY			KEY. Datafill the 2 part key consisting of CAINPRT and FROMDIGS refinements.
	CAINPRT	Vector of up to 16 characters	Enter up to 16 characters from table CNPRTNUM.

CAINPRT (continued)**CAINPRT Field descriptions (Sheet 2 of 4)**

Field	Subfield or refinement	Entry	Explanation and action
	FROMDIGS	Vector of up to 24 digits (0 to 9, *, #)	Indicates the beginning of the digit range for this tuple to be used as the collectible for a given key. Note: Only enter * or # as the first digit. The digit values from least to greatest are: 0 1 2 3 4 5 6 7 8 9 * #.
TODIGS		Vector of up to 24 digits (0 to 9, *, #)	Indicates the beginning of the digit range for this tuple to be used as the collectible for a given key. Note: Only enter * or # as the first digit. The digit values from least to greatest are: 0 1 2 3 4 5 6 7 8 9 * #.
COLLTYPE		ACCT, ADDR, AUTH, CARD, PIN	Indicates the O_Feature_Requested collectible type.
MIN		0 to 24	Indicates the minimum number of digits to collect for this collectible.
MAX		0 to 24	Indicates the maximum number of digits to collect for this collectible. This field must be greater than or equal to the number of digits specified in the digit ranges.
COLLLIST		Vector of up to four multiples with COLLTYPE refinements.	Indicates a vector of up to four collectible types. See the same behavior in COLLTYPE in table OFTRREQ.
	COLLTYPE	NIL, CAINPRT, PIN, CARD, AUTH, ADDR, ACCT, ANNC	COLLECTION TYPE. Enter up to four COLLTYPES.
		NIL	Enter NIL to change an already datafilled collection type.
		CAINPRT	Enter value from table CNPRTNUM.

CAINPRT (continued)**CAINPRT Field descriptions (Sheet 3 of 4)**

Field	Subfield or refinement	Entry	Explanation and action
		PIN	PERSONAL IDENTIFICATION DIGITS. Enter a resource index (0 to 4095), interrupt status (Y or N), minimum digits (0 to 24), maximum digits (0 to 24), and a timer value (0 to 15).
		CARD	CARD. Enter a resource index (0 to 4095), interrupt status (Y or N), minimum digits (0 to 24), maximum digits (0 to 24), and a timer value (0 to 15). Note: You cannot provision a card and auth collectible in the same tuple.
		AUTH	AUTHORIZATION CODE. Enter a resource index (0 to 4095), interrupt status (Y or N), minimum digits (0 to 24), maximum digits (0 to 24), and a timer value (0 to 15). Note: You cannot provision a card and auth collectible in the same tuple.
		ADDR	ADDRESS. Enter a resource index (0 to 4095), interrupt status (Y or N), minimum digits (0 to 24), maximum digits (0 to 24), and a timer value (0 to 15).
		ACCT	ACCOUNT CODE. Enter a resource index (0 to 4095), interrupt status (Y or N), minimum digits (0 to 24), maximum digits (0 to 24), and a timer value (0 to 15).
		ANNC	ANNOUNCEMENT. Enter a resource index (0 to 4095) and interrupt status (Y or N), minimum digits (0 to 24), maximum digits (0 to 24), and a timer value (0 to 15).
		AUTH	Enter AUTH to collect authorization information and datafill the COLLYTYPE refinement.

CAINPRT (continued)**CAINPRT Field descriptions (Sheet 4 of 4)**

Field	Subfield or refinement	Entry	Explanation and action
CAINPRT_ VECTOR		Vector of up to one CAINPRT type	Indicates a vector of up to one index of another CAINPRT tuple along with a resource indicator, and interruptible flag, and a timer value.
	CAINPRT	Value from table CNPRTNUM	
	RSRCIND	0 to 4095	CAIN resource to be played for the collectible. Enter a resource index (0 to 4095).
	INTERRUPT	N, Y	Enter an interrupt status (Y or N).
	TIMER	0 to 15	Set the PSIG timer value (0 to 15).

COLLIST=CAINPRT

If the entry in field COLLIST, refinement COLLTYPE, is CAINPRT, enter the following.

Field descriptions for conditional datafill

Refinement	Subfield or refinement	Entry	Explanation and action
CAINPRT		Value from table CNPRTNUM	
RSRCIND		0 to 4095	CAIN resource to be played for the collectible. Enter a resource index (0 to 4095).
INTERRUPT		N, Y	Enter an interrupt status (Y or N).
TIMER		0 to 15	Set the PSIG timer value (0 to 15).

CAINPRT (continued)

COLLIST=PIN, CARD, AUTH, ADDR, or ACCT

If the entry in field COLLIST, refinement COLLYPE, is PIN, CARD, AUTH, ADDR, or ACCT, enter the following.

Field descriptions for conditional datafill

Refinement	Subfield or refinement	Entry	Explanation and action
RSRCIND		0 to 4095	CAIN resource to be played for the collectible. Enter a resource index (0 to 4095).
INTERRUPT		N, Y	Enter an interrupt status (Y or N).
MINDIGS		0 to 24	
MAXDIGS		0 to 24	
TIMER		0 to 15	Set the PSIG timer value (0 to 15).

COLLIST=ANNC

If the entry in field COLLIST, refinement COLLYPE, is ANNC, enter the following.

Field descriptions for conditional datafill

Refinement	Subfield or refinement	Entry	Explanation and action
RSRCIND		0 to 4095	CAIN resource to be played for the collectible. Enter a resource index (0 to 4095).
INTERRUPT		N, Y	Enter an interrupt status (Y or N).

Datafill example

The following example shows sample datafill for table CAINPRT.

MAP display example for table CAINPRT

```

CAINPRTKEY TODIGS COLLYPE MIN MAX COLLIST CAINPRT_VECTOR
-----
UA_PRT 0      1 ADDR 10 10 CARD 4 N 7 10 15 $ ACCT1 17 N 15 $
ACCT1  0      9 ACCT 12 12 PIN 6 N 4 4 10 $ $
ACCT1  445    448 ACCT 12 12 $  $
    
```

Table history

UCS08

Feature AX0199 created this table.

CAINRESP

Table name

Carrier Advanced Intelligent Network Response (CAINRESP) table

Functional description

Table CAINRESP is used to create an SCP simulator for use in testing Carrier AIN functionality.

Table CAINRESP datafill provides the data necessary to build a response to a CAIN query. The simulator encodes the data into a TCAP message and sends a response to the CAIN framework.

Refer to the *UCS DMS-250 NetworkBuilder Application Guide* for more information on the SCP simulator; refer to the *UCS DMS-250 Programmable Service Node (PSN) Application Guide* for PSN information.

Restrictions

ATTENTION

All TCAP protocol restrictions are enforced by the SCP simulator. Non-restricted messages can be provisioned for robustness testing. TCAP protocol is not enforced for robustness testing.

The following restrictions apply to normal SCP simulator provisioning:

A restriction is placed on the CHANGE operation on the table as a whole. If a tuple of CAINRESP is referenced by any other tuple (tables CAINCONV, CAINMTCH, or CAINRESP), the restrictions in the following table apply. Deletion of referenced tuples remains impossible.

CHANGE operation restrictions

Old Operation Type	New Operation Type	Restriction
<ANY>	Non-restricted	None
Restricted	Restricted	The package type must stay the same.
Non-restricted	Restricted	Not possible

Robustness testing

Technicians can perform robustness testing by using nonrestricted operation types at any OPERTYPE subfield. Technicians can also provision

CAINRESP (continued)

nonrestricted operation types by including the “_NR” suffix to the operation type. The available nonrestricted operations are:

- ANALYZE_ROUTE_NR
- AUTHORIZE_TERMINATION_NR
- CONTINUE_NR
- DISCONNECT_NR
- SEND_TO_RESOURCE_NR
- REPORT_ERROR_NR
- FAILURE_REPORT_NR
- APPL_ERROR_NR
- CLOSE_NR
- CANCEL_RESOURCE_NR
- REQ_REP_BCM_NR
- CONNECT_TO_RESOURCE_NR
- COLLECT_INFORMATION_NR
- CALL_INFO_TO_RESOURCE_NR
- SEND_NOTIFICATION_NR
- ACG_NR
- ACGGLOBAL_CTRL_RESTORE_NR
- ORIGINATE_CALL_NR
- MERGE_CALL_NR
- DISCONNECT_LEG_NR
- MERGE_LEG_NR
- ACKNOWLEDGE_NR
- FURNISH_AMA_INFORMATION_NR

Robustness testing allows the user to datafill errors that can occur in communication between the CAIN framework and the SCP. Technicians can enter data for the following for robustness testing:

- nonrestricted operations with normally invalid package and component types
- conversation with permission using regular or nonrestricted operations
- operations with invalid parameters

CAINRESP (continued)

Any rules pertaining to parameter types are not enforced and technicians can specify any parameter to test CAIN robustness.

Datafill sequence and implications

Datafill table CAINRESP before table CAINMTCH.

Table size

0 to 1504 tuples

Memory requirements

Tuples in table CAINRESP dynamically allocate required memory. The minimum memory allocated is 64 kbytes and the maximum is 3,008 kbytes.

Field descriptions

The following tables describe field names, subfield names, and valid data ranges for table CAINRESP.

Table CAINRESP field descriptions

Field	Subfield or refinement	Entry	Explanation and action
RESPKEY		0 to 16 alphanumeric characters	RESPONSE KEY. This field contains the response identifier used in tables CAINMTCH, CAINRESP and CAINCONV to index table CAINRESP.
DATATYPE		CR, NCR	CALL RELATED or NON-CALL RELATED. This field describes the type of data in the call response. Refer to tables CAINRESP and DATATYPE for DATATYPE subfield descriptions.

CAINRESP (continued)**DATATYPE=NCR**

When DATATYPE=NCR, datafill the following fields

DATATYPE=NCR subfield descriptions

Field	Subfield or refinement	Entry	Explanation and action
COMPTYPE		INVL, RERR, REJ, RRL, INVNL, RRNL	COMPONENT TYPE. This refinement contains the TCAP component type for the message. INVL is the only valid entry: <ul style="list-style-type: none"> INVL - invoke (last); refer to Table "COMPTYPE=INVL" for refinement datafill.
OPERTYPE		See explanation	OPERATION TYPE. This field specifies the type of operation to be returned to the Service Switching Point (SSP).
		REQ_REP_BCM	REQUEST_REPORT_BCM_EVENT. Enter REQ_REP_BCM to build a <i>Request_Report_BCM_Event</i> message. Datafill the refinements in Table "REQ_REP_BCM parameter values".
		SEND_NOTIFIC ATION	Enter SEND_NOTIFICATION to build a <i>Send_Notification</i> message. Datafill the refinements in Table 27.
		ACG	Enter ACG to build an <i>ACG</i> message. Datafill the refinements in Table "ACG parameter values".
		ACGGLOBAL_C TRL_RESTORE	Enter ACGGLOBAL_CTRL_RESTORE to build a <i>ACGglobal_Ctrl_Restore</i> message. Datafill the refinements in Table "ACGGLOBAL_CTRL_RESTORE parameter values".
EXTPARM		Valid entry in table CAINREXT or \$	EXTENSION PARAMETERS. Enter a valid index into table CAINREXT or \$.

CAINRESP (continued)**DATATYPE=CR**

When DATATYPE=CR, datafill the following fields

DATATYPE=CR subfield descriptions

Field	Subfield or refinement	Entry	Explanation and action
DELAY		0 to 99	DELAY. This field contains a time, in seconds, used to simulate network/SCP congestion.
PKGAREA		see subfields	PACKAGE AREA. This field contains the data necessary to create a response to a CAIN query.
	PKGTYPE	CWPQWPRES UNIABORT_P	<p>PACKAGE TYPE. This field contains the TCAP package type for the message. Enter one of the following:</p> <ul style="list-style-type: none"> • CWP - conversation with permission package. Refer to Table "PKGTYPE=CWP" for refinement datafill. • QWP - query with permission • RESP - response package. Refer to Table "PKGTYPE=RESP" for refinement datafill. • UNI - unidirectional package. Refer to Table "PKGTYPE=UNI" for refinement datafill. • ABORT_P - abort package. Refer to Table "PKGTYPE=ABORT_P" for refinement datafill.
NCRCOMPS		a vector of up to 3 indices to index NCR tuples	NON-CALL RELATED COMPONENTS. Enter a vector of up to 3 indices to index non-call related tuples in table CAINRESP.

CAINRESP (continued)

PKGTYPE=CWP

When PKGTYPE=CWP, datafill the following refinements:

PKGTYPE=CWP refinement descriptions

Refinement	Subfield or refinement	Entry	Explanation and action
COMPTYPE		INVLRRERR EJ, RRL, INVNL, RRNL	<p>COMPONENT TYPE. This refinement contains the TCAP component type for the message. Enter one of the following:</p> <ul style="list-style-type: none"> • INVL - invoke (last); refer to Table "COMPTYPE=INVL or INVNL" for refinement datafill. • RERR - return error; refer to Table "COMPTYPE=RERR" for refinement datafill. • RRL - Return Result Last component type identifies the type of message the RRL component represents. Refer to Table "COMPTYPE=RRL or RRNL" for refinement datafill. • INVNL, RRNL, REJ, appear for robustness testing only; refer to Table "COMPTYPE=INVL or INVNL", Table "COMPTYPE=RRL or RRNL", Table "COMPTYPE=REJ" for refinement datafill.
EXTPARM		Valid entry in table CAINREXT or \$	EXTENSION PARAMETERS. Enter a valid index into table CAINREXT or \$.

CAINRESP (continued)**PKGTYPE=RESP**

When PKGTYPE=RESP, datafill the following refinements:

PKGTYPE=RESP refinement descriptions

Refinement	Subfield or refinement	Entry	Explanation and action
COMPTYPE		INVLRERRR EJ, RRL, INVNL, RRNL	<p>COMPONENT TYPE. This refinement contains the TCAP component type for the message. Enter one of the following:</p> <ul style="list-style-type: none"> • INVL - invoke (last); refer to Table "COMPTYPE=INVL or INVNL" for refinement datafill. • RERR - return error; refer to Table "COMPTYPE=RERR" for refinement datafill. • RRL - Return Result Last component type identifies the type of message the RRL component represents. Refer to Table "COMPTYPE=RRL or RRNL" for refinement datafill. • INVNL, RRNL, REJ appear for robustness testing only; refer to table "COMPTYPE=INVL or INVNL", Table "COMPTYPE=RRL or RRNL", or Table "COMPTYPE=REJ" for refinement datafill.
EXTPARM		Valid entry in table CAINREXT or \$	EXTENSION PARAMETERS. Enter a valid index into table CAINREXT or \$.

CAINRESP (continued)

PKGTYPE=UNI

When PKGTYPE=UNI, datafill the following refinements:

PKGTYPE=UNI refinement descriptions

Refinement	Subfield or refinement	Entry	Explanation and action
COMPTYPE		INVL	COMPONENT TYPE. This refinement contains the TCAP component type for the message.
OPERTYPE			OPERATION TYPE. This field contains the operation type for the message.
		REPORT_ERROR	Enter REPORT_ERROR to build a <i>Report_Error</i> message. Datafill the refinements in Table 25.
EXTPARM		Valid entry in table CAINREXT or \$	EXTENSION PARAMETERS. Enter a valid index into table CAINREXT or \$.

PKGTYPE=ABORT_P

When PKGTYPE=ABORT_P, datafill the following refinements:

PKGTYPE=ABORT_P refinement descriptions

Refinement	Subfield or refinement	Entry	Explanation and action
CAUSE		NIL_ABORTUNRECOGNIZED_PACKAGE_TYPEINCORRECT_TRANSACTION_PORTION BADLY_STRUCTURED_TRANSACTION_UNRECOGNIZED_TRANSACTION_ID PERMISSION_TO_RELEASE_PROBLEM RESOURCE_UNAVAILMAX_ABORT_CAUSE	ABORT CAUSE. Enter the appropriate abort cause.

CAINRESP (continued)**COMPTYPE=INVL or INVNL**

When COMPTYPE=INVL or INVNL, datafill the following refinements:

COMPTYPE=INVL or INVNL refinement descriptions

Refinement	Subfield or refinement	Entry	Explanation and action
OPERTYPE			OPERATION TYPE. This refinement contains the operation type for the message.
		ANALYZE_ROUTE	Enter ANALYZE_ROUTE to build an <i>Analyze_Route</i> message. Datafill the refinements in Table "Analyze_Route parater values".
		CONTINUE	Enter CONTINUE to build a <i>Continue</i> message. Datafill the CAIN_PARM_VALUE refinement in Table "Continue and Disconnect parameter values".
		SEND_TO_RESOURCE	Enter SEND_TO_RESOURCE to build a <i>Send_To_Resource</i> message. Datafill the refinements in Table "Connect_To_Resource and Send_To_Resource parameter values".
		CONNECT_TO_RESOURCE	Enter CONNECT_TO_RESOURCE to build a <i>Connect_To_Resource</i> message. Datafill the refinements in Table 21.
		AUTHORIZE_TERMINATION	Enter AUTHORIZE_TERMINATION to build an <i>Authorize_Termination</i> message. Datafill the refinements in Table "Authorize_Termination parameter values".
		COLLECT_INFORMATION	Enter COLLECT_INFORMATION to build a <i>Collect_Information</i> message. Datafill the refinements in Table "Colect_Information parameter values".
		MERGE_CALL	Enter MERGE_CALL to build a <i>Merge_Call</i> message. MERGE_CALL has no refinements.

CAINRESP (continued)

COMPTYPE=RERR

When COMPTYPE=RERR, datafill the following refinements:

COMPTYPE=RERR refinement descriptions

Refinement	Subfield or refinement	Entry	Explanation and action
OPERTYPE		APPL_ERROR	Enter APPL_ERROR to indicate that the switch needs to build an <i>Application_Error</i> message.
	APPL_ERROR_STRING	DATA_ERRMISS _PARMT1_EXPI REUNEXP_ COMMUNEXP_ MSGUNXP_ MSGSEQUNXP_ PRMSEQ	Enter one of the following application error strings: <ul style="list-style-type: none"> • DATA_ERR - data error • MISS_PARM - missing parameter • T1_EXPIRE - T1 timeout • UNEXP_COMM - unexpected communication • UNEXP_MSG - unexpected message • UNXP_MSGSEQ - unexpected message sequence • UNXP_PRMSEQ - unexpected parameter sequence

COMPTYPE=RRL or RRNL

When COMPTYPE=RRL or RRNL, datafill the following refinements:

COMPTYPE=RRL or RRNL refinement descriptions

Refinement	Subfield or refinement	Entry	Explanation and action
RR_SCENARIO		NON_RESTRICTED	Any parameters that can be provisioned in CAINRESP can be provisioned into the RRL component.
		CALL_INFO_TO_RESOURCE	The CALL_INFO_TO_RESOURCE message is used to provide a response to the information received from the SSP during an active STR-connection.

CAINRESP (continued)**COMPTYPE=RRL or RRNL refinement descriptions**

Refinement	Subfield or refinement	Entry	Explanation and action
	BLOCKTYPE		Refer to Table "Connect_To_Resource and Send_To_Resource parameter values" for refinement datafill.
		NIL	Enter NIL to remove an existing parameter.
		RESOURCE_TYPE	The RESOURCE_TYPE parameter indicates the type of resource to which the user needs to be connected. See refinement for Datafill.
	RESOURCE_TYPE	PLAY_ANN, COLL_DIGS, FLEX_PARM	The RESOURCE_TYPE parameter identifies the requested resource (play announcement or play announcement and collect digits), or it can identify the FLEX parameter block (to define resources in a flexible manner).

COMPTYPE=RERR

When COMPTYPE=RERR, datafill the following refinements:

COMPTYPE=RERR refinement descriptions

Refinement	Subfield or refinement	Entry	Explanation and action
OPERTYPE			OPERATION TYPE. This refinement contains the operation type for the message.
		FAILURE_REPORT	Enter FAILURE_REPORT to build a <i>Failure_Report</i> message. Datafill the refinement in Table "Failure_Report parameter values".

CAINRESP (continued)

COMPTYPE=RERR refinement descriptions

Refinement	Subfield or refinement	Entry	Explanation and action
		APPL_ERROR	Enter APPL_ERROR to build an <i>Application_Error</i> message. Datafill the APPL_ERROR_STRING refinement.
	APPL_ERROR_STRING	DATA_ERRMISS_P ARMT1_EXPIREUN EXP_COMMUNEXP MSGUNXP_MSGS EQUNXP_PRMSEQ	Enter one of the following application error strings: <ul style="list-style-type: none"> • DATA_ERR - data error • MISS_PARM - missing parameter • T1_EXPIRE - T1 timeout • UNEXP_COMM - unexpected communication • UNEXP_MSG - unexpected message • UNXP_MSGSEQ - unexpected message sequence • UNXP_PRMSEQ - unexpected parameter sequence

COMPTYPE=REJ

When COMPTYPE=REJ, datafill the following refinements:

COMPTYPE=REJ refinement descriptions

Refinement	Subfield or refinement	Entry	Explanation and action
FAMILY		GENERAL_PROBLEM	FAMILY. Enter the problem family.
PROBLEM		NIL_GENERAL_PROB UNRECOGNIZED_COMPONENT INCORRECT_COMPONENT_PORTIONB AD_COMPONENT_STRUCTUREMAX_G ENERAL_PROB	PROBLEM. Enter the problem.

CAINRESP (continued)**Analyze_Route parameter values**

The Analyze_Route parameter can have the following values:

Analyze_Route parameter values

CAIN_PARM_VALUE	Subfield or refinement	Entry/format	Definition
NIL			Enter NIL to remove a parameter.
ALTTRK			ALTERNATE TRUNK. Enter ALTTRK and datafill the TRK_DATA refinement.
PRITRK			PRIMARY TRUNK. Enter PRITRK and datafill the TRK_DATA refinement.
SALTTRK			SECOND ALTERNATE TRUNK. Enter SALTTRK and datafill the TRK_DATA refinement.
	TRK_DAT A	userid opsl	Where, <i>userid</i> is the symbolic name defined in the key of table CAINUID and consists of CAINUID_SWITCH_NAME and CAINUID_CLLI_NAME. <i>opsl</i> is the outpulse flag (Y or N)
ALT_CAR			ALTERNATE CARRIER. Enter ALT_CAR and provision the CARRIER_DATA refinement.
SALT_CAR			SECOND ALTERNATE CARRIER. Enter SALT_CAR and provision the CARRIER_DATA refinement.
CARRIER			CARRIER DIGITS PARAMETER. The carrier digits parameter is datafilled with a carrier identification code. Enter CARRIER and provision the CARRIER_DATA refinement

CAINRESP (continued)**Analyze_Route parameter values**

CAIN_PARM_VALUE	Subfield or refinement	Entry/format	Definition
	CARRIER_DATA	carsel digits	Where, <i>carsel</i> is the carrier selection type (NO_INDICATION, PRESUBSCRIBED_AND_NOT_INPUT, PRESUBSCRIBED_AND_INPUT, PRESUBSCRIBED_AND_NO_INDICATION, NOT_PRESUBSCRIBED_AND_INPUT). <i>digits</i> is a vector of up to 4 digits containing the carrier identification code (0000-9999).
CHGNO			CHARGE NUMBER. Enter CHGNO and datafill the DIGITS refinement in Table "DIGITS refinement".
CLDNO			CALLED NUMBER. Enter CLDNO and datafill the DIGITS refinement in Table "DIGITS refinement".
CLGNO			CALLING NUMBER. Enter CLGNO and datafill the DIGITS refinement in Table "DIGITS refinement".
AMASLPID		Vector of 9 digits	AMASLPID. The AMASLPID parameter is sent to populate the SLPID CDR field. Enter AMASLPID and provision the AMASLPID REFINEMENT.
ECHO_CHGNO			ECHO CHARGE NUMBER. Enter ECHO_CHGNO and datafill the DIGITS refinement in Table "DIGITS refinement".
ECHO_CLGNO			ECHO CALLING NUMBER. Enter ECHO_CLGNO and datafill the DIGITS refinement in Table "DIGITS refinement".
ECHO_CLDNO			ECHO CALLED NUMBER. Enter ECHO_CLDNO and datafill the DIGITS refinement in Table "DIGITS refinement".

CAINRESP (continued)**Analyze_Route parameter values**

CAIN_PARM_VALUE	Subfield or refinement	Entry/format	Definition
ECHO_CAR			ECHO CARRIER. Enter ECHO_CAR and datafill the DIGITS refinement in Table "DIGITS refinement".
OPULSNO			OUTPUT NUMBER. Enter OPULSNO and datafill the DIGITS refinement in Table "DIGITS refinement".
FCI		1 to 15 characters{A,B,C,D,E,F,G,H,I,J,K,L,M,N,O,P}	FORWARD CALL INDICATOR. Enter 1 to 15 characters. The entry here controls the FCI of the TCAP message that is returned to call processing. Each selected letter represents an active FCI bit. At least one bit must be selected, and M and N cannot be active at the same time.
GENADDR			GENERIC ADDRESS. Datafill the ADDRESS_TYPE and DIGITS refinements.
	ADDRESS_TYPE	ALTOPNO, SALTOPNO, OVFLWNO, PORTEDNO, DNIS	Enter address type ALTOPNO, SALTOPNO, OVFLWNO, PORTEDNO, or DNIS and datafill the Digits refinement in Table "DIGITS refinement".
	DIGITS	ALTOPNO, SALTOPNO, OVFLWNO, PORTEDNO, DNIS	Enter address type ALTOPNO, SALTOPNO, OVFLWNO, PORTEDNO, or DNIS and datafill the Digits refinement in Table "DIGITS refinement".
AMABUSCU STID		11 digits	AMABusinessCustomerId. Enter a value up to 11 digits to indicate the AMABusinessCustomerId. Other operation types supported are Disconnect and Send_To_Resource.
AMADIGS			AMA DIGITS DIALED WC. Enter AMADIGS and see AMADIGS parameter values in table "AMADIGS refinement" for datafill.

CAINRESP (continued)**Analyze_Route parameter values**

CAIN_PARM_VALUE	Subfield or refinement	Entry/format	Definition
AMALNNUM			AMALineNumber parameter. This parameter contains information such as the calling party ID or ANI, depending on the value of the Line Number Type. Enter the AMA_LNNUM_TYPE and DIGITS sub-refinements.
	AMA_LNNUM_TYPE	005, 006	Enter value 005 (Calling Party Identification) or 006 (Automatic Number Identification)
	DIGITS	a vector of up to 24 digits	Enter a vector of up to 24 digits.
AMAALTBN			AMAAlternateBillingNumber. This parameter contains an alternate number to which the AIN service can be billed. Enter AMAALTBN and datafill the DIGITS refinement in Table "DIGITS refinement".
CARRUSG		0, 1, 2	CARRIER USAGE. Enter values 0, 1, or 2 for <i>CarrierUsage</i> refinement.
AMP1		None	AIN MAINTENACE PARAMETER. AMP1 is a test parameter that does not affect call processing or require datafiling.
OVFLBIND			OVERFLOW BILLING INDICATOR. Datafill two fields of <i>OverflowBillingIndicator</i> , <i>AMACallType</i> (AMACT) and <i>Service Feature Identification</i> (SERVFTID).
	AMACT	3 digits	AMA CALL TYPE. Datafill with 3 digit AMA call type field value.
	SERVFTID	3 digits.	SERVICE FEATURE IDENTIFICATION. Datafill with 3 digit Service Feature ID field value.

CAINRESP (continued)**ACG parameter values**

The ACG parameter can have the following values:

ACG parameter values

CAIN_PAR M_VALUE	Subfield or refinement	Entry	Explanation and action
CCI		SCP, SOCC	CONTROL CAUSE INDICATOR. The CCI indicates whether the control is an SCP overload or an SMS initiated control. Enter SCP or SOCC.
NUMDIGS		1 to 10	NUMBER OF DIGITS. Enter a value of 1 to 10.
INTERVAL		0_SECONDS, 3_SECONDS, 4_SECONDS, 6_SECONDS, 8_SECONDS, 11_SECONDS, 16_SECONDS, 22_SECONDS, 30_SECONDS, 42_SECONDS, 58_SECONDS, 81_SECONDS, 112_SECONDS, 156_SECONDS, 217_SECONDS, 300_SECONDS, REM_GAP_CTRL, ONETENTH_SEC, QUARTER_SEC, HALF_SECOND, 1_SECOND, 2_SECONDS	GAP INTERVAL. The gap interval contains the minimum length in seconds that the SSP must wait before sending another query of the type under the control.

CAINRESP (continued)

ACG parameter values

CAIN_PARM_VALUE	Subfield or refinement	Entry	Explanation and action
DURATION		1_SECOND, 2_SECONDS, 4_SECONDS, 8_SECONDS, 16_SECONDS, 64_SECONDS, 128_SECONDS, 256_SECONDS, 512_SECONDS, 1024_SECONDS, 2048_SECONDS, INFINITY	GAP DURATION. The gap duration contains the length in seconds that an ACG control should be applied before it times out.
TT		0 to 255	TRANSLATION TYPE. The translation type is an integer from 0 to 255 indicating the translation type of the ACG control.
GTA		0 to 10 digits	GLOBAL TITLE ADDRESS. The GTA is a string of digits indicating the global title address of the ACG control. Enter 0 to 10 digits.

ACGGLOBAL_CTRL_RESTORE parameter values

The ACGGLOBAL_CTRL_RESTORE parameter can have the following values:

ACGGLOBAL_CTRL_RESTORE parameter values

CAIN_PARM_VALUE	Subfield or refinement	Entry/format	Definition
ACGGLOBAL_OVERRIDE		ALL_ITEMS, SCP_ITEMS, SOCC_NOT_ZERO, SOCC_ITEMS, NTMOS_NOT_ZERO, RO, NTMOS_ITEMS, CRAFT_NOT_ZERO, RO, CRAFT_ITEMS	Datafill the ACGGLOBAL_OVERRIDE_RANGE with the appropriate entry.

CAINRESP (continued)**ACKNOWLEDGE parameter values**

The ACKNOWLEDGE parameter can have the following values:

ACKNOWLEDGE parameter values

CAIN_PARM_V ALUE	Subfield or refinement	Entry	Explanation and action
NIL			Enter NIL to remove an existing parameter.
CSID			This parameter is used to indicate which call segment the message is intended for.
	CSID	1 to 2	The range is 1 to 2 for CSIDs.

Authorize_Termination parameter values

The Authorize_Termination parameter can have the following values:

Authorize_Termination parameter values

CAIN_PARM_V ALUE	Subfield or refinement	Entry/format	Definition/Explanation
CLGNO		See explanation.	Enter CLGNO and datafill the DIGITS refinement in Table "DIGITS refinement".
AMADIGS			AMA DIGITS DIALED WC. Enter AMADIGS and see AMADIGS parameter values in table "AMADIGS refinement" for datafill.
DISPLAY TEXT	DISPLAYTEXT	See explanation.	Enter a 2-part multiple refinement for value and tag as follows: <ul style="list-style-type: none"> • VALUE: Vector of up to 16 characters • TAG: CLGPTY_NAME, ORIG_CALLED_NAME, REDIR_NAME
AMALNNUM			AMALineNumber Parameter. This parameter contains information such as the calling party ID or ANI, depending on the value of the Line Number Type. Enter the AMA_LNNUM_TYPE and DIGITS refinements.

CAINRESP (continued)

Authorize_Termination parameter values

CAIN_PARM_V ALUE	Subfield or refinement	Entry/format	Definition/Explanation
	AMA_ LNNUM_ TYPE	005, 006	Enter value 005 (Calling Party Identification) or 006 (Automatic Number Identification)
	DIGITS	a vector of up to 24 digits	Enter a vector of upto 24 digits.
AMAALBN			AMAAlternateBillingNumber. This parameter contains an alternate number to which the AIN service can be billed. Enter AMAALBN and datafill the DIGITS refinement in Table "DIGITS refinement".

Close parameter values

The Close parameter can have the following values:

Close parameter values

CAIN_PARM_V ALUE	Subfield or refinement	Entry/format	Definition
USERID		userid	Where, <i>userid</i> is the symbolic name defined in the key of table CAINUID and consists of CAINUID_SWITCH_NAME and CAINUID_CLLI_NAME.
BEARCAP		SPEECHF3_1K HZF7_KHZF56 KBPSF64KBPS MULTI	Enter a bearer capability.
CLOSECSE		CALL_TERM,E DP_COMPL,U NEXP_ COMM,ANSWE R	Enter one of the following close causes: <ul style="list-style-type: none"> • CALL_TERM - call terminated, used for robustness testing • EDP_COMPL - event detection point complete, used for robustness testing • UNEXP_COMM - unexpected communication • ANSWER - called party answered

CAINRESP (continued)**Collect_Information parameter values**

The Collect_Information parameter can have the following values:

Collect_Information parameter values

CAIN_PARM_V ALUE	Subfield or refinement	Entry/format	Definition
NIL			Enter NIL to remove an existing parameter.
CLGNO		See explanation.	
AMALNNUM			AMALineNumber Parameter. This parameter contains information such as the calling party ID or ANI, depending on the value of the Line Number Type. Datafill the AMA_LNNUM_TYPE and DIGITS sub-refinements.
	AMA_LNNUM_ TYPE	005, 006	Enter value 005 (Calling Party Identification) or 006 (Automatic Number Identification)
	DIGITS	a vector of up to 24 digits	Enter a vector of upto 24 digits.
AMAALTBN			AMAAlternateBillingNumber. This parameter contains an alternate number to which the AIN service can be billed. Enter AMAALTBN and datafill the DIGITS refinement in Table "DIGITS refinement".
AMADIGS			AMA DIGITS DIALED WC. Enter AMADIGS and see AMADIGS parameter values in table "AMADIGS refinement" for datafill.

CAINRESP (continued)**Collect_Information parameter values**

The Collect_Information parameter can have the following values:

Connect_To_Resource and Send_To_Resource parameter values

CAIN_PARM_V ALUE	Subfield or refinement	Entry/format	Definition
RESOURCE		PLAY_ANN,CO LL_DIGITS, or FLEX_PARM	Enter PLAY_ANN (play announcement), COLL_DIGITS (collect digits), or FLEX_PARM (allows the operating person to enter data into the FlexParameterBlock).
BLOCKTYPE			Enter ANN, ANNDIG or FLEX.
		ANN	When RESOURCE=PLAY_ANN, enter ANN and datafill the sub-refinements.
	BLK_FORMAT	UNINTERINTE R	Enter UNINTER to specify an uninterruptible announcement is to be played. Enter INTER to specify an interruptible announcement is to be played. Datafill the ANN_BLOCK refinement.
			Note: Datafill uninterruptible resources before interruptible resources.
	ANN_BLOCK	0 to 4095	Enter up to 3 announcements blocks. An announcement block consists of an ANN_ID (0 to 4095), which indexes table CAINRSRC for announcement play and INFO_DIGS (up to 12 digits).
			Note: Information digits are ignored by CAIN.
		ANNDIG	When RESOURCE=COLL_DIGITS, enter ANNDIG and datafill the DIGS_TYPE refinement.
	DIGS_TYPE	FIXED, UP_TO, VARIABLE, NORMAL	Enter the type of digits the SCP needs to collect.

CAINRESP (continued)**Connect_To_Resource and Send_To_Resource parameter values**

CAIN_PARM_V ALUE	Subfield or refinement	Entry/format	Definition
	BLK_FORMAT1	UNINTERINTE R	Enter UNINTER to specify an uninterruptible announcement is to be played. Enter INTER to specify an interruptible announcement is to be played. Datafill the ANN_BLOCK refinement. Note: Datafill uninterruptible resources before interruptible resources.
	ANN_BLOCK	0 to 4095	Enter up to 3 announcements blocks. An announcement block consists of an ANN_ID (0 to 4095), which indexes table CAINRSRC for announcement play and INFO_DIGS (up to 12 digits). Note: Information digits are ignored by CAIN.
	BLK_FORMAT2	NILINTER FLEX	Enter NIL to remove a parameter. Enter INTER to specify an interruptible announcement is to be played. Datafill the the ANN_BLOCK refinement. Note: Datafill uninterruptible resources before interruptible resources. When RESOURCE=FLEX_PARM, enter FLEX and data fill the FLEX_FORMAT refinement.
	FLEX_PARM _HEX	Vector of up to 112 tables of 2 alphanumeric characters (0 to 9, A to F)	The raw HEX block allows you to provision up to 112 octets for the payload of the FlexParameterBlock.
	FLEX__PARM _NT	VIP	The NT block has a VIP encoded that identifies the data collected and populates the appropriate CDR fields.

CAINRESP (continued)**Connect_To_Resource and Send_To_Resource parameter values**

CAIN_PARM_V ALUE	Subfield or refinement	Entry/format	Definition
VIP_COLL		NIL, ANNC, ADDR, AUTH, PIN, ACCT, CARD, UNKNOWN	Vector of up to eight collectibles.
INTERRUPTIB LE		Y, N	Enter VIP interruptible type. Enter a bool.
RSRC		0 to 4095	RESOURCE. Index into table CAINRSRC.
TIMER		0 to 15	Applies to all collectibles except ANNC.
MIN		0 to 24	Applies to all collectibles except ANNC.
MAX		0 to 24	Applies to all collectibles except ANNC.
DISCFLAG			Presence indicates disconnect flag.
ANSWIND			Presence indicates answer indicator. Note: ANSWIND is not allowed in the Connect_To_Resource message.
DESTADDR			Enter DESTADDR to define the destination address of an IP. This field requires an NOA (NATL), numbering plan (ISDN), and up to 24 digits.
AMAMEAS			AMAMeasure Parameter. Enter AMAMEAS and datafill the AMAMEAS refinement.
	AMAMEAS	CTRDSSP, CTRDSCP, CTNOTREC	CTRDSSP-connectTimeRecordedDestinationSSP. This is the only value recognized by NetworkBuilder. NetworkBuilder treats any other value as if the parameter were not present in the message. CTRDSCP-connectTimeRecordedDestinationSCP, CTNOTREC-connectTimeNotRecorded

CAINRESP (continued)**Connect_To_Resource and Send_To_Resource parameter values**

CAIN_PARM_V ALUE	Subfield or refinement	Entry/format	Definition
AMADIGS			Enter AMADIGS and see AMADIGS parameter values in Table "AMADIGS refinement" for datafill.
AMABUSCUST ID		11 digits	AMABusinessCustomerId. Enter a value up to 11 digits to indicate the AMABusinessCustomerId. Other operation types supported are Disconnect and Send_To_Resource.
LEGID	LEGID	0 to 2	LEG IDENTIFICATION. Enter LEGID and datafill the LEGID refinement. This parameter specifies which leg of a call to connect to a resource. Note: LEGID is not allowed in the Send_To_Resource message.
NIL			Enter NIL to remove an existing parameter.
AMALNNUM			AMALineNumber Parameter. This parameter contains information such as the calling party ID or ANI, depending on the value of the Line Number Type. Datafill the AMA_LNNUM_TYPE and DIGITS sub-refinements.
	AMA_LNNUM_ TYPE	005, 006	Enter value 005 (Calling Party Identification) or 006 (Automatic Number Identification)
	DIGITS	a vector of up to 24 digits	Enter a vector of upto 24 digits.
AMAALTBN			AMAAlternateBillingNumber. This parameter contains an alternate number to which the AIN service can be billed. Enter AMAALTBN and datafill the DIGITS refinement in Table "DIGITS refinement".

CAINRESP (continued)**Connect_To_Resource and Send_To_Resource parameter values**

CAIN_PARM_V ALUE	Subfield or refinement	Entry/format	Definition
PRIBIND			PRIMARY BILLING INDICATOR. <i>PrimaryBillingIndicator</i> consists of two fields, <i>AMACallType</i> (AMACT) and <i>Service Feature Identification</i> (SERVFTID).
	AMACT	a vector of up to 3 digits	AMA CALL TYPE. Datafill with 3 digit AMA call type field value.
	SERVFTID	a vector of up to 3 digits.	SERVICE FEATURE INDENTIFICATION. Datafill with 3 digit Service Featrue ID field value.

CAINRESP parameter values

The CAINRESP parameter can have the following values:

Continue and Disconnect parameter values

CAIN_PARM_V ALUE	Subfield or refinement	Entry/format	Definition
NIL			Enter NIL to remove an existing parameter.
AMADIGS			Enter AMADIGS and see AMADIGS parameter values in Table "AMADIGS refinement" for datafill.
AMABUSCUST ID		11 digits	AMABusinessCustomerId. Enter a value up to 11 digits to indicate the AMABusinessCustomerId. Other operation types supported are Disconnect and Send_To_Resource.
AMALNNUM			AMALineNumber Parameter. This parameter contains information such as the calling party ID or ANI, depending on the value of the Line Number Type. Datafill the AMA_LNNUM_TYPE and DIGITS sub-refinements.
	AMA_LNNUM_ TYPE	005, 006	Enter value 005 (Calling Party Identification) or 006 (Automatic Number Identification)

CAINRESP (continued)**Continue and Disconnect parameter values**

CAIN_PARM_V ALUE	Subfield or refinement	Entry/format	Definition
	DIGITS	a vector of upto 24 digits	Enter a vector of upto 24 digits.
AMAALTBN			AMAAlternateBillingNumber. This parameter contains an alternate number to which the AIN service can be billed. Enter AMAALTBN and datafill the DIGITS refinement in Table "DIGITS refinement".

Disconnect_Leg parameter values

The Disconect_Leg parameter can have the following values:

Disconnect_Leg parameter values

CAIN_P ARM_V ALUE	Subfield or refinement	Entry/format	Definition
LEGID			This parameter specifies which leg of a call to connect to a resource.
	LEGID	0 to 2	Enter a LEGID type of 0 to 2.
	CAIN_PARM_VALUE	NIL or CSID	Enter NIL to remove an existing parameter.

CAINRESP (continued)

Failure_Report parameter values

The Failure_Report parameter can have the following values:

Failure_Report parameter values

CAIN_PARM_V ALUE	Subfield or refinement	Entry/format	Definition
FAILURECAUSE		HIGH_RATEN O_RSRCCHNL BUSYABORT_ FRSRC_LIMAP PL_ERRPROT _ERRTIMER_E XPTMP_FAIL CTRL_ENCBA D_CODE	Enter one of the following failure causes: <ul style="list-style-type: none"> • HIGH_RATE - rate too high • NO_RSRC - no resource • CHNLBUSY - channel busy • ABORT_F - abort • RSRC_LIM - resource limitation • APPL_ERR - application error • PROT_ERR - protocol error • TIMER_EXP - T1 timer expired • TEMP_FAIL - temporary failure • CTRL_ENC - control encountered • BAD_CODE - improper coding

Originate_Call parameter values

The Originate_Call parameter can have the following values:

Originate_Call parameter values

CAIN_PARM_V ALUE	Subfield or refinement	Entry/format	Definition
NIL			Enter NIL to remove an existing parameter.
CLGNO		See explanation.	
DISPLAY TEXT			

CAINRESP (continued)**Originate_Call parameter values**

CAIN_PARM_V ALUE	Subfield or refinement	Entry/format	Definition
	DISPLAYTEXT	See explanation.	Enter a 2-part multiple refinement for value and tag as follows: <ul style="list-style-type: none"> • VALUE: Vector of up to 16 characters • TAG: CLGPTY_NAME, ORIG_CALLED_NAME, REDIR_NAME
BEARCAP		SPEECHF3_1K HZF7_KHZF56 KBPSF64KBPS MULTI	Enter a bearer capability.
CHGNO			CHARGE NUMBER. Enter CHGNO and datafill the DIGITS refinement in Table "DIGITS refinement".
CHGPTYST		0 to 99	Enter charge party station type.
CLDNO			CALLED NUMBER. Enter CLDNO and datafill the DIGITS refinement in Table "DIGITS refinement".
OPULSNO			OUTPUT NUMBER. Enter OPULSNO and datafill the DIGITS refinement in Table "DIGITS refinement".
FCI		1 to 15 characters{A,B, C,D,E,F,G,H,I,J ,K,L,M,N,O,P}	FORWARD CALL INDICATOR. Enter 1 to 15 characters. The entry here controls the FCI of the TCAP message that is returned to call processing. Each selected letter represents an active FCI bit. At least one bit must be selected, and M and N cannot be active at the same time.
ALTTRK			ALTERNATE TRUNK. Enter ALTTRK and datafill the TRK_DATA refinement.
PRITRK			PRIMARY TRUNK. Enter PRITRK and datafill the TRK_DATA refinement.
SALTTRK			Enter SALTTRK and datafill the TRK_DATA refinement.

CAINRESP (continued)

Originate_Call parameter values

CAIN_PARM_V ALUE	Subfield or refinement	Entry/format	Definition
	TRK_DATA	userid opls	Where, <i>userid</i> is the symbolic name defined in the key of table CAINUID and consists of CAINUID_SWITCH_NAME and CAINUID_CLLI_NAME. <i>opls</i> is the outpulse flag (Y or N)
ALT_CAR			ALTERNATE CARRIER. Enter ALT_CAR and provision the CARRIER_DATA refinement.
SALT_CAR			SECOND ALTERNATE CARRIER. Enter SALT_CAR and provision the CARRIER_DATA refinement.
CARRIER			CARRIER DIGITS PARAMETER. The carrier digits parameter is datafilled with a carrier identification code. Enter CARRIER and provision the CARRIER_DATA refinement.
	CARRIER_DATA	carsel digits	Where, <i>carsel</i> is the carrier selection type (NO_INDICATION, PRESUBSCRIBED_AND_NOT_INPUT, PRESUBSCRIBED_AND_INPUT, PRESUBSCRIBED_AND_NO_INDICATION, NOT_PRESUBSCRIBED_AND_INPUT). <i>digits</i> is a vector of up to 4 digits containing the carrier identification code (0000-9999).
GENADDR			GENERIC ADDRESS. Datafill the ADDRESS_TYPE and DIGITS refinements.
	ADDRESS_TYPE	ALTOPNO, SALTOPNO, OVFLWNO, PORTEDNO, DNIS	Enter address type ALTOPNO, SALTOPNO, OVFLWNO, PORTEDNO, or DNIS and datafill the DIGITS refinement.

CAINRESP (continued)**Originate_Call parameter values**

CAIN_PARM_V ALUE	Subfield or refinement	Entry/format	Definition
	DIGITS	ALTOPNO, SALTOPNO, OVFLWNO, PORTEDNO, DNIS	Enter address type ALTOPNO, SALTOPNO, OVFLWNO, PORTEDNO, or DNIS and datafill the DIGITS refinement.
AMASLPID		Vector of 9 digits	The AMASLPID parameter is used to populate the SLPID CDR field. Enter AMASLPID and provision the AMASLPID refinement.
AMADIGS			Enter AMADIGS and see AMADIGS parameter values in Table "AMADIGS refinement" for datafill.
AMALNNUM			AMALineNumber. This parameter contains information such as the calling party ID or ANI, depending on the value of the Line Number Type. Datafill the AMA_LNNUM_TYPE and DIGITS sub-refinements.
	AMA_LNNUM_ TYPE	005, 006	Enter value 005 (Calling Party Identification) or 006 (Automatic Number Identification)
	DIGITS	a vector of up to 24 digits	Enter a vector of upto 24 digits.
AMAALTBN			AMAAlternateBillingNumber. This parameter contains an alternate number to which the AIN service can be billed. Enter AMAALTBN and datafill the DIGITS refinement in Table "DIGITS refinement".

CAINRESP (continued)**Report_Error parameter values**

The Report_Error parameter can have the following values:

Report_Error parameter values

CAIN_PARM_VALUE	Subfield or refinement	Entry/format	Definition
APPL_ERROR_STRING		DATA_ERRMISS_PARM_T1_EXPIRE UNEXP_COMMU_NEXP_MSGUNXP_MSGSEQUNXP_PRMSEQ	<p>Enter one of the following application error strings:</p> <ul style="list-style-type: none"> • DATA_ERR - data error • MISS_PARM - missing parameter • T1_EXPIRE - T1 timeout • UNEXP_COMM - unexpected communication • UNEXP_MSG - unexpected message • UNXP_MSGSEQ - unexpected message sequence • UNXP_PRMSEQ - unexpected parameter sequence

REQ_REP_BCM parameter values

The REQ_REP_BCM parameter can have the following values:

REQ_REP_BCM parameter values

CAIN_PARM_VALUE	Subfield or refinement	Entry/format	Definition
NIL			Enter NIL to remove an existing parameter.
EDPREQ		NETBUSY, OCLDBUSY, TIMEOUT, ONOANSWR, SHF, ODISC, OABANDON	EVENT DETECTION POINT REQUEST. Define up to four EDPs to be armed to send an EDP-Request to the SCP.
EDPNOTIF		OTERMSZ, ODISC, or OANSWR	EVENT DETECTION POINT NOTIFICATION. Enter up to three EDPs to be armed to send an EDP-Notification to the SCP.

CAINRESP (continued)**REQ_REP_BCM parameter values**

CAIN_PARM_VALUE	Subfield or refinement	Entry/format	Definition
ONOANSWT		1 to 120	O_NO_ANSWER_TIMER. Enter the amount of time (in seconds) to wait before encountering the <i>O_No_Answer</i> EDP.
TNOANSWT		1 to 120	T_NO_ANSWER_TIMER. Not yet supported.
TIMEOUTT		1 to 180	TIMEOUT_TIMER. Enter the amount of time (in minutes) to wait before encountering a <i>Timeout</i> event.

Send_Notification parameter values

The send_Notification parameter can have the following values:

Send_Notification parameter values

FIELD	Subfield or refinement	Entry/format	Definition
ECHODATA		a string of up to 12 hexadecimal characters	This parameter is used to associate the SCP SEND_NOTIFICATION message with the SSP TERMINATION_NOTIFICATION message.

CAINRESP (continued)

AMADIGS refinements

The AMADIGS field can have the following refinements:

AMADIGS refinement

Field	Subfield	Entry/format	Definition
AMADIGS			AMA DIGITS DIALED WC. This parameter is sent to provide any digit string the customer dials along with a context ID to indicate the name of the digit string. Datafill the sub-refinements for AMADIGS.
	AMA_DIGS_TYPE	001 to 006, 011, 012, 300 to 305, 999	Enter a three digit context identifier.
	DIGITS	a vector of up to 24 hexadecimal digits	Enter a vector of up to 24 digits.

CAINRESP (continued)**DIGITS refinements**

The DIGITS field can have the following refinements:

DIGITS refinement

Field	Subfield	Entry	Explanation and action
DIGITS		see sub- refinements	Enter nature of address, numbering_plan and digits by datafilling the NATURE_OF_ADDR, NUMBERING_PLAN, and DIGITS subfields.
	NATURE_OF_ADDR	UNK, NATL, INTL, ACCT, ANI, I2ANI, AUTH, HOTL, MCCS, PIN, VPN, N00, PART, SUBR, NON_UNI_SUBR, NON_UNI_NATL, NON_UNI_INTL, TEST_SUBR_OP, NATL_OP, INTL_OP, NO_NUM_OP, NO_NUM_CT, 950_CT, CLGP_SUBR, CLGP_NOT, CLGP_NATL, CLDP_SUBR, CLDP_NOT, CLDP_NATL, SPR	NATURE OF ADDRESS. Enter a NOA.
	NUMBERING_PLAN	UNK, ISDN, TELE, RSV1, RSV2, PRVT, RSV4, RSV5	NUMBERING PLAN. Enter a numbering plan.
	DIGITS	0 to 24 digits	DIGITS. Enter a vector of up to 24 digits (for example: 1, 2, 3, 4, 5, 6, 7, 8, 9, 0, *, #). Note: Enter a vector of up to 16 digits for the GENADDR parameter.

CAINRESP (continued)

FURNISH_AMA_INFORMATION non -call related operation

The FURNISH_AMA_INFORMATION operation type can have the following parameters:

FURNISH_AMA_INFORMATION parameter values

CAIN_PARM_VALUE	Subfield	Entry	Explanation and action
AMABAFMD			AMABAFMD. The <i>AMABAFModules</i> parameter is optional.
AMAABIND		TRUE, FALSE	AMAABIND. The <i>AMASetHexABIndicator</i> parameter is optional

Datafill example

The following example shows sample datafill for table CAINRESP.

```

RESPKEY DATAREA
-----
SITA CR 0 RESP INVL ANALYZE_ROUTE
(PRITRK DALLAS DAL220 N) $ $ $

MATT CR 0 RESP INVL ANALYZE_ROUTE
(PRITRK DALLAS DAL222 N) $ $ $

WAYNE CR 0 RESP INVL ANALYZE_ROUTE
(PRITRK DALLAS DAL221 N) $ $ $

JEN CR 0 RESP INVL ANALYZE_ROUTE (ALTTRK DALLAS DAL221 N)
(PRITRK DALLAS DAL220 N) (CHGNO I2ANI PRVT 002146113311)
(CLDNO VPN PRVT 2201234) $ $ $

ALTBIL_TEST CR 0 RESP INVL ANALYZE_ROUTE
(CLDNO NATL ISDN 2142281265) (AMADIGS 305 12345678) (AMASLPID 12345678)
(AMAALTBN UNK UNK 2146112211) $ $ $

CLDNO_DALTIE CR 0 RESP INVL ANALYZE_ROUTE
(CLDNO NATL ISDN 2153408918) $ $ $

KIMSRESP_ROUTE CR 0 RESP INVL ANALYZE_ROUTE
(CLDNO NATL ISDN 2142575555)
(FCI (M ) $) (GENADDR PORTEDNO NATL ISDN 2142575555) $ $ $
    
```

CAINRESP (continued)

Table history**SN07 (DMS)**

Added parameter AMABUSCUSTID according to feature A00005363.

UCS14

Added SPR, a new Nature Of Address (NOA) for all CAIN query parameters which use the AINDigits type. Added new parameters CARRUSG, AMPI, and OVFLBIND to ANALYZE_ROUTE and ANALYZE_ROUTE_NR operation types. Added PREBIND parameter to SEND_TO_RESOURCE. and SEND_TO_RESOURCE_NR operation types. Added new response message, invoke (last) components FURNISH_AMA and FURNISH_AMA_NR. FURNISH_AMA and FURNISH_AMA_NR contain parameters AMABAFMD, and AMAABIND (A60008667).

UCS12

Updated to add editorial comments.

UCS11

Added ORIGINATE_CALL, MERGE_CALL, DISCONNECT_LEG and ACKNOWLEDGE to CR operation type (AX1372). Updated EDPREQ parm value to include SHF, ODISC, and OABANDON values (AX1372). Added parameters AMALNNUM and AMAALTBN to Analyze_Route, Continue, Disconnect, Send_To_Resource, Authorize_Termination, Connect_To_Resource and Collect_Information operation types (AX1373).

UCS09

Added value 305 to the range of AMA_DIGS_TYPE field (AX0953). Added SEND_NOTIFICATION and SEND_NOTIFICATION_NR to NCR operation types (AX0972). Added ACG, ACG_NR, ACGGLOBAL_CTRL_RESTORE, ACGGLOBAL_CTRL_RESTORE_NR to OPERTYPE for NCR (AX0975).

UCS08

Feature AX0186 makes the following changes:

- allows *Call_Info_To_Resource* operation
- adds LEGID value to CAIN_STR_PARM_VALUE
- adds the Virtual IP feature, the ability to datafill the *FlexParameterBlock* and the *AMAMeasure* parameter
- adds the *Connect_To_Resouce* and *Collect_Information* messages

CAINRESP (end)

Feature AX0188 makes the following changes:

- adds fields RESOURCE and BLOCKTYPE

Feature AX0190 adds the following fields:

- RR_SCENARIO
- RESOURCE_TYPE
- FLEX_FORMAT
- FLEX_PARM_BLOCK (for FLEX_PARM_HEX)
- AMAMEAS

Feature AX0197 makes the following changes:

- adds the *Authorize_Termination* message
- adds DISPLAYTEXT refinement to the CAIN_PARM_VALUE

Feature AX0200 makes the following changes:

- adds TIMEOUT refinement to EDPREQ
- adds ODISC to EDPNOTIF

UCS07

The following changes are made:

- Expanded CAIN_PARM_VALUE to include FCI
- Added DATATYPE field.
- Moved most extension parameters to table CAINREXT and added indexes to that table.
- Multiple-component responses are allowed.
- The *Request_Report_BCM_Event* operation is allowed.

UCS06

Table CAINRESP was updated to allow conversational messaging.

UCS05

Table CAINRESP was created.

CAINREXT

Table name

Carrier Advanced Intelligent Network Response Extension Parameters (CAINREXT) table

Functional description

This table contains the extension parameters for table CAINRESP. Table CAINREXT allows the technician to provision extension parameters to be sent in messages to the switch. The indices in this table are references from tuples in table CAINRESP.

Datafill sequence and implications

There is no requirement to datafill other tables before table CAINREXT.

Enter data into table CAINREXT before table CAINRESP.

Table size

0 to 1504 tuples. The size is set when CAINREXT is datafilled at the Initial Program Load. Each tuple in the table changes when the STS parameter is selected.

Datafill

The following table lists datafill for table CAINREXT.

Field descriptions

Field	Subfield or refinement	Entry	Explanation and action
REXTKEY		character string	Enter an alphanumeric string for the REXTKEY field.
CUSTOMER_SELECTOR		NT	CUSTOMER_SELECTOR. Enter value before entering EXTPARM.
EXTPARMS		Vector of up to 24 extension parameters	EXTENSION PARAMETERS. Enter the EXTPARM values below and their refinements.
		NIL	Enter NIL to remove an existing parameter.
		STS	Serving Translation Scheme: Determines what type of translation scheme will be used.

CAINREXT (continued)**Field descriptions**

Field	Subfield or refinement	Entry	Explanation and action
	STS_VALUE	0 to 999	Contains the value of the STS given by the SCP.
		PRISTS	STS to be used with <i>PrimaryTrunkGroup</i> parameter.
	STS_VALUE	0 to 999	Contains the value of the STS given by the SCP.
		ALTSTS	STS to be used with the <i>AlternateTrunkGroup</i> parameter.
	STS_VALUE	0 to 999	Contains the value of the STS given by the SCP.
		SALTSTS	STS to be used with the <i>SecondAlternateTrunkGroup</i> parameter.
	STS_VALUE	0 to 999	Contains the value of the STS given by the SCP.
		OVFLSTS	STS to be used with the <i>OverflowRoutingNo</i> parameter.
	STS_VALUE	0 to 999	Contains the value of the STS given by the SCP.
		PREXLA	Contains a valid index into table CNPREXLA.
	PREXLA	0 to 255	Enter a valid index value.
		CALLCTRL	Contains the call control type which determines how call processing should handle a match in a trigger detection point. See refinement below.
	CALLCTRL	NIL, LEAVE_TDP, CONT_NOTRIG	Enter the call control type. (NIL doesn't set a default response. LEAVE_TDP tells the switch to ignore the match and continue at the next trigger detection point. CONT_NOTRIG ignores the match and continues trying to connect the call, but without further CAIN processing.)

CAINREXT (continued)**Field descriptions**

Field	Subfield or refinement	Entry	Explanation and action
		UNIVIDX	The Universal Translation Identifier indicates what system of universal translation will be used by the switch.
	UNIVIDX	NIL, AC, PX, CT, FA, OFC, AM, FT, NSC	Enter the short name of a translation system.
		NETINFO	Network information is contained in this extension parameter.
	EXTNETID	0 to 32767	Enter the external network identifier.
	NETCGID	0 to 4095	Enter the network customer group identifier.
	NCOS	0 to 511	Enter the network class of service identifier.
		CALLTYPE	Call Type categorizes calls as on or off network.
	CALLTYPE_VAL LUE	ONNET, OFFNET, FORCED_ONNET, VIRTUAL_ONNET	Specify the calltype here.
		SATREST	Satellite Restriction restricts a call from routing to an agent with a satellite link.
		COS	Class of Service contains an index to the in-switch class of service screening table MULTICOS.
	SRVCLASS_VAL ALUE	0 to 2047	Enter the index number here.
		BILLSEQ	Billing Sequence Number contains a 32-bit binary value which will be entered into the switch's CDR.
	BILLSEQ_VAL UE	Implicit Octet String	Enter the binary value here.

CAINREXT (continued)**Field descriptions**

Field	Subfield or refinement	Entry	Explanation and action
		BRANDING	Call Branding contains an announcement ID value.
	ANNOUNCEMENT_ID	32768 to 32767	Enter the announcement ID value here.
		CONNECT_TO_SCU	Connect to SCU allows the AIN SCP to indicate to the switch that it should terminate AIN call processing and enter the Programmable Isoprenoid mode. Control is then passed over to the PSN SCU.
		CAINGRP	CAIN Subscription Group sends the value of the GRPNUM field of table CAINGRP for the group that caused the call in process to query.
	CAINGRP	0 to 4095	Enter the value of the GRPNUM field here.
		TREATMENT	This parameter is sent to the switch to indicate treatment should be set.
	TREATMENT	0 to 255	Enter the actual treatment here.
		REORIG_ALLOWED	Reorigination Allowed Indicator. This is sent to the switch to indicate if reorigination is allowed.
	NUM_TRIES	0 to 99	Enter the number of successive reorigination attempts allowed.
		NETBACT	NETWORK BUSY ACTIONS. Datafill the RTEAVAIL, RTESDONE, and TERM RTE_GNCT refinements to define default actions for when the <i>Network_Busy</i> EDP is encountered.
	RTEAVAIL	REQUEST, IGNORE, or NEXTRTE	Specify a default action to take when additional routes are available.
	RTESDONE	REQUEST, IGNORE	Specify a default action to take when no additional routes are available.

CAINREXT (continued)**Field descriptions**

Field	Subfield or refinement	Entry	Explanation and action
	TERMRTE_GNCT	REQUEST,IGNORE, NEXTRTE, or NEXTCNRTE	Specify a default action to take when the route choice determined by direct termination routing through table TERMRTE is busy.
		OCLDBACT	O CALLED PARTY BUSY ACTIONS. Datafill the RTEAVAIL and RTESDONE refinements to define default actions for when the <i>O_Called_Party</i> EDP is encountered.
	RTEAVAIL	REQUEST,IGNORE, NEXTRTE, or NEXTCNRTE	Specify a default action to take when additional routes are available.
	RTESDONE	REQUEST,IGNORE	Specify a default action to take when no additional routes are available.
		ONOANACT	O NO ANSWER ACTIONS. Datafill the RTEAVAIL and RTESDONE refinements to define default actions for when the <i>O_No_Answer</i> EDP is encountered.
	RTEAVAIL	REQUEST,IGNORE, NEXTRTE, or NEXTCNRTE	Specify a default action to take when additional routes are available.
	RTESDONE	REQUEST or IGNORE	Specify a default action to take when no additional routes are available.
		EDPBUFFR	Event Detection Point Buffer. When this is entered, digits will be buffered when an EDP-request is sent.
		STRCONTP	Contains the type of connection protocol to be used when establishing a connection between the switch and an IP.
	CONNECT_TYPE	NONE, CONNECT_ONLY, CONNECT_1129_STYLE	Enter the connection type protocol value.

CAINREXT (continued)**Field descriptions**

Field	Subfield or refinement	Entry	Explanation and action
		BILLNUM	BILLING NUMBER. Enter refinement to match a query against the parameter. Refer to Table 2 for datafill.
		PINDIGS	PERSONAL IDENTIFICATION NUMBER. Enter refinement to match a query against the parameter. Refer to Table 2 for datafill.
		ACCTCODE	ACCOUNT CODE. Enter refinement to match a query against the parameter. Refer to Table 2 for datafill.
		AMADIGS	AMA DIGITS DIALED. This parameter is sent to provide any digit string the customer dials along with a context ID to indicate the name of the digit string. Datafill the sub-refinements for AMADIGS.
	AMA_DIGS_TY PE	001 to 006, 011, 012, 300 to 305, 999	Enter a three digit context identifier.
	DIGITS	a vector of up to 24 hexadecimal digits	Enter a vector of up to 24 digits.
		SHFELEGS	SWITCH HOOK FLASH ENABLED LEG. This parameter indicates which leg the SSP will monitor for a switchHookFlash. Enter a vector of up to 2 legs in the SHFELEGS refinement below.
	SHFELEGS	LEG0, LEG1	Enter values LEG0 or LEG1.

CAINREXT (continued)**DIGITS Refinement**

Field	Subfield or refinement	Entry	Explanation and action
DIGITS		see refinements	Enter nature of address, numbering_plan and digits by datafilling the NATURE_OF_ADDR, NUMBERING_PLAN, and DIGITS subfields.
	NATURE_OF_ADDR	UNK, NATL, INTL, ACCT, ANI, I2ANI, AUTH, HOTL, MCCS, PIN, VPN, N00, PART, SUBR, NON_UNI_SUBR, NON_UNI_NATL, NON_UNI_INTL, TEST_SUBR_OP, NATL_OP, INTL_OP, NO_NUM_OP, NO_NUM_CT, 950_CT, CLGP_SUBR, CLGP_NOT, CLGP_NATL, CLDP_SUBR, CLDP_NOT, CLDP_NATL	NATURE OF ADDRESS. Enter a NOA.
	NUMBERING_PLAN	UNK, ISDN, TELE, RSV1, RSV2, PRVT, RSV4, RSV5	NUMBERING PLAN. Enter a numbering plan.
	DIGITS	0 to 24 digits	DIGITS. Enter a vector of up to 24 digits (for example: 1, 2, 3, 4, 5, 6, 7, 8, 9, 0, *, #).

Datafill example

The following example shows sample datafill for table CAINREXT.

CAINREXT (end)

MAP display example for table CAINREXT

```
REXTKEY  EXTPARMS
-----
EXT0  $
EXT1  (STS 611) $
EXT2  (BILLSEQ 12345678) $
EXT3  (BILLSEQ ABCDEF12) $
EXT4  (REORIG_ALLOWED 3) $
```

Table history

SN07 (DMS)

Added context identifier 300 to field AMA_DIGS_TYPE according to feature A00005363.

UCS14

Added new field, CUSTOMER_SELECTOR (A60008667).

UCS12

Updated to include editorial changes.

UCS11

Added extension parameter switchHookFlashEnabledLeg (AX1372).

UCS09

Added new value, 305, to AMA_DIGS_TYPE (AX0953). Added extension parameters Billing Number, AccountCode and PIN (AX0973).

UCS08

Feature AX0190 modifies table CAINREXT to support the Digit Type for `amaDigits` extension parameter.

Feature AX0188 adds the `pretranslatorName` and `amaDigits` extension parameters.

Table AX0206 adds extension parameters `primaryTrunkGroupSTS`, `alternateTrunkGroupSTS`, `secondAlternateTrunkGroupSTS`, `overflowRoutingNoSTS`.

UCS07

Table CAINREXT is created.

CAINRSRC**Table name**

Carrier Advanced Intelligent Network Resource (CAINRSRC)

Functional description

Table CAINRSRC is used when a response is received from the SCP. The table maps each of the following into an announcement resource implemented on the SSP:

- the AnnouncementID (encoded in the of the *Connect_To_Resource*, *Call_Info_To_Resource*, or *Send_To_Resource* message).
- the callBranding extension parameter (encoded in an *Analyze_Route* message) to an announcement resource implemented on the SSP.
- The PLAY_ANN option in table ONOANSWR (added by AX0952T) contains a code (corresponding to the announcement to be played) that indexes table CAINRSRC.
- The Standard Announcement parameter of the *Play_Announcement* message (added by AX1377) contains a code (corresponding to the announcement to be played) that indexes table CAINRSRC.

Datafill sequence and implications

Datafill a valid announcement CLLI in table DRAMTRK or a valid TONE CLLI in table TONES before datafilling announcements or tones in table CAINRSRC.

Table size

0 to 4095 tuples

Field descriptions

The following table describes field names, subfield names, and valid data ranges for table CAINRSRC.

CAINRSRC field descriptions

Field	Subfield or refinement	Entry	Explanation and action
RSRCID		0 to 4095	RESOURCE ID. The RSRCID is received from the SCP in the <i>Send_To_Resource</i> message encoded in the <i>AnnouncementBlock</i> .
RSRCCLLI		Valid CLLI	RESOURCE CLLI. Enter a valid announcement CLLI (valid CLLIs are datafilled in tables DRAMTRK and TONES).

CAINRSRC (end)

Datafill example

The following example shows datafill for table CAINRSRC.

RSRCID	RSRCCLLI
9	CAINAUTH
14	CAINMSG
16	CAINPDIL

Table history

UCS12

Updated to include editorial changes.

UCS06

Size of table is increased to 4096 tuples.

UCS05

Table CAINRSRC is created.

CAINSTS

Table name

Carrier Advanced Individual Network (CAIN) Serving Translations Scheme (STS)

Functional description

The CAINSTS table indicates that the switch should not perform an LNP trigger table lookup for the given STS when the NO_LNP option is datafilled against the STS in the table.

Datafill sequence and implications

The STS must be datafilled in table HNPACONT before it can be datafilled in table CAINSTS.

Table size

0 to 1000 tuples

Field Descriptions

Field descriptions for table CAINSTS follow.

Field descriptions

Field	Subfield or refinement	Entry	Explanation and action
STS	SERVING_ TRANSLATION _SCHEME	0 to 999	KEY. Represents the STS for the call.
OPTIONS		NIL, NO_LNP	Only one instance of the two possible values displays, once entered. When NIL is datafilled by itself, \$ displays. If NIL and NO_LNP are both entered, the switch accepts both but only displays and uses NO_LNP. Vector of up to four multiples with CAINSTS_OPTIONS.

Datafill example

The following example shows sample datafill for table CAINSTS.

CAINSTS (end)

MAP display example for table CAINSTS

OPTIONS	STS
611	(NO_LNP) \$

Table history **UCS08**

Feature AX0198 created table CAINSTS.

CAINUID**Table name**

Carrier Advanced Intelligent Network (AIN) User Identification (CAINUID)

Functional description

Table CAINUID is one of four tables creating an SCP simulator for use in testing Carrier AIN functionality.

Table CAINUID provides a symbolic names for trunk groups and switches used in the simulator. It is similar to tables CLLI and CLLICDR in functions. The use of symbolic names rather than numbers provides enhanced clarity when datafilling the simulator tables.

Table size

0 to 1500 tuples

Memory requirements

Table CAINUID allocates 47 kbytes of memory.

Datafill sequence and implications

Datafill table CAINUID before tables CAINRESP and CAINKEY.

Field descriptions

The following table describes field names, subfield names, and valid data ranges for table CAINUID.

CAINUID field descriptions (Sheet 1 of 2)

Field	Subfield or refinement	Entry	Explanation and action
KEY		see subfields	KEY. Datafill the 2-part key consisting of: CAINUID_SWITCH_NAME and CAINUID_CLLI_NAME.
	CAINUID_SWITCH_NAME	Up to 15 alphanumeric characters	CAINUID SWITCH NAME. Enter a symbolic switch name for use with the SCP simulator.
	CAINUID_CLLI_NAME	Up to 16 alphanumeric characters	CAINUID COMMON LANGUAGE LOCATION IDENTIFIER. Enter a symbolic name for use with the SCP simulator.

CAINUID (end)

CAINUID field descriptions (Sheet 2 of 2)

Field	Subfield or refinement	Entry	Explanation and action
SWI TCHI D		0 to 999	SWITCH IDENTIFIER. Enter a switch identifier associated with the symbolic switch defined in the KEY. This number corresponds to table OFCVARs ORIG_SWITCH_ID parameter.
GRO UPN UM		0 to 32767	GROUP NUMBER. Enter the group number for the switch. This number corresponds to the ADNUM field in table CLLI.

Datafill example

The following example shows datafill for table CAINUID.

SWITCHID_KEY	TRUNK_GROUP_KEY	SWITCH_IDNUM	USERID
DALLAS	DAL220TWDTGS	111	00012
DALLAS	DAL221TWDTLS	111	00044
HOUSTON	PRI731TWMFWK	222	08765
OTTAWA	EAN611TWMFWK	444	04444
RALEIGH	EAN611TWMFWK	555	05555

Table history

UCS09

Increased SWITCHID field range to 999 (AX0960).

UCS05

Table CAINUID is created.

CAINXDFT

Table name

Carrier AIN Extension Parameter Defaults (CAINXDFT)

Functional description

Table CAINXDFT provides default values for all extension parameters. When a necessary extension parameter is missing in an SCP response to a query, CAIN call processing uses the values defined in table CAINXDFT. The key to table CAINXDFT is CAINGRP. The default values for the following extension parameters are associated with a call's CAIN group:

- servTranslationScheme
- callType
- satRestriction
- classOfSvc
- callBranding
- networkBusyActions
- oCalledPartyBusyActions
- oNoAnswerActions
- edpBuffer
- univIdx
- netinfo
- primaryTrunkGroupSTS
- alternateTrunkGroupSTS
- secondAlternateTrunkGroupSTS
- overflowRoutingNoSTS
- strConnectionType
- shfelegs
- inlRequery

Datafill sequence and implications

Datafill table CAINGRP before table CAINXDFT. All valid CAINGRPs must be entered in table CAINGRP before using them in table CAINXDFT.

Note: The default values defined in table CAINXDFT are not validated by the switch. Any value is accepted as long as it falls within the documented range.

CAINXDFT (continued)

The values PRISTS, ALTSTS, SALTSTS, OVFLSTS of the DEFPARMS field must be valid values provisioned in table HNPACONT.

Table size

0 to 2048 tuples

Field descriptions

The following table describes field names, subfield names, and valid data ranges for table CAINXDFT.

CAINXDFT field descriptions (Sheet 1 of 5)

Field	Subfield or refinement	Entry	Explanation and action
CAINGRP		Valid CAIN group defined in table CAINGRP	CARRIER AIN GROUP. Enter a valid CAIN group defined in table CAINGRP.
DEFPARMS			DEFINITION PARAMETERS. Default values for one or more of the extension parameters are defined. Enter up to 19 multiples.
		NIL	NIL. Enter NIL to remove a default.
		STS	SERVING TRANSLATION SCHEME. Enter STS to define a default STS. Datafill the STS refinement.
	STS	0 to 999	Enter a default STS for in-switch translation. This STS is used when an applicable <code>servTranslationScheme</code> extension parameter is missing from the SCP response.
		PRISTS	STS to be used with <i>PrimaryTrunkGroup</i> parameter.
	PRISTS	0 to 999	Enter a default STS for in-switch translation. This STS is used when an applicable <code>primaryTrunkGroupSTS</code> extension parameter is missing from the SCP response.
		ALTSTS	STS to be used with the <i>AlternateTrunkGroup</i> parameter.

CAINXDFT (continued)**CAINXDFT field descriptions (Sheet 2 of 5)**

Field	Subfield or refinement	Entry	Explanation and action
	ALTSTS	0 to 999	Enter a default STS for in-switch translation. This STS is used when an applicable <code>alternateTrunkGroupSTS</code> extension parameter is missing from the SCP response.
		SALTSTS	STS to be used with the <code>SecondAlternateTrunkGroup</code> parameter.
	SALTSTS	0 to 999	Enter a default STS for in-switch translation. This STS is used when an applicable <code>secondAlternateTrunkGroupSTS</code> extension parameter is missing from the SCP response.
		OVFLSTS	STS to be used with the <code>OverflowRoutingNo</code> parameter.
	OVFLSTS	0 to 999	Enter a default STS for in-switch translation. This STS is used when an applicable <code>overflowRoutingNoSTS</code> extension parameter is missing from the SCP response.
		CALLTYPE	CALL TYPE. Enter CALLTYPE to define a default call type. Datafill the CALLTYPE refinement.
	CALLTYPE	ONNET,OFFNET,FORCED_ONNET,VIRTUAL_ONNET	Enter a default call type for use by CAIN call processing when an applicable <code>callType</code> extension parameter is missing from the SCP response.
		SATREST	SATELLITE RESTRICTIONS. Enter SATREST to indicate satellite routing restrictions are enforced. This option is used by CAIN call processing if the applicable <code>satRestriction</code> extension parameter is missing from the SCP response.
		COS	CLASS OF SERVICE. Enter COS to define a default class of service. Datafill the COS refinement.

CAINXDFT (continued)**CAINXDFT field descriptions (Sheet 3 of 5)**

Field	Subfield or refinement	Entry	Explanation and action
	COS	0 to 2047	Enter a default COS for use by CAIN call processing when an applicable <code>classOfSvc</code> extension parameter is missing from the SCP response. This value is used to index table MULTICOS for multi-COS screening.
		CALLBRND	CALL BRANDING. Enter CALLBRND to define a default brand. Datafill the CALLBRND refinement.
	CALLBRND	0 to 4095	Enter a default branding value for use by CAIN call processing when the <code>callBranding</code> extension parameter is missing from the SCP response.
		NETBACT	NETWORK BUSY ACTIONS. Datafill the RTEAVAIL, RTESDONE, and TERMRTE_GNCT refinements to define default actions for when the Network_Busy EDP is encountered.
	RTEAVAIL	REQUEST IGNORE NEXT RTE	Specify a default action to take when additional routes are available.
	RTESDONE	REQUESTIGNO RE	Specify a default action to take when no additional routes are available.
	TERMRTE_ GNCT	REQUESTIGNO RENEXTRTENE XTCNRTE	Specify a default action to take when the route choice determined by direct termination routing through table TERMRTE is busy.
		OCLDBACT	O CALLED PARTY BUSY ACTIONS. Datafill the RTEAVAIL and RTESDONE refinements to define default actions for when the O_Called_Party_Busy EDP is encountered.
	RTEAVAIL	REQUESTIGNO RENEXTRTENE XTCNRTE	Specify a default action to take when additional routes are available.
	RTESDONE	REQUESTIGNO RE	Specify a default action to take when no additional routes are available.

CAINXDFT (continued)**CAINXDFT field descriptions (Sheet 4 of 5)**

Field	Subfield or refinement	Entry	Explanation and action
		ONOANACT	O NO ANSWER ACTIONS. Datafill the RTEAVAIL and RTESDONE refinements to define default actions for when the O_No_Answer EDP is encountered.
	RTEAVAIL	REQUESTIGNO RENEXTRTENE XTCNRTE	Specify a default action to take when additional routes are available.
	RTESDONE	REQUESTIGNO RE	Specify a default action to take when no additional routes are available.
		EDPBUFFR	When entered, EDPBUFFR indicates that digits should be buffered when an EDP-request is sent.
		UNIVIDX	The Universal Translation Identifier indicates what system of universal translation will be used by the SSP. Datafill the UNIVIDX refinement.
	UNIVIDX	NIL, AC, PX, CT, FA, OFC, AM, FT, NSC	Enter the short name of a translation system. SOC GIMT0001 (DMS switch in global market) must be enabled to use this field.
		STRCONTP	STR-CONNECTION TYPE. Provides the default STR-Connection type. See refinement below.
	STR_CONN _TYPE	NONE, CONNECT_ ONLY, CONNECT_ 1129_STYLE	Enter one of the subtype values, specifying the type of connection protocol the switch is to use when establishing a connection between the switch and an IP.
		NETINFO	NETWORK INFORMATION. Will provide default values for netinfo if needed values are not given by the SCP.
	EXTNETID	0 to 32767	This value sets a default external network.
	NETCGID	0 to 4095	This value sets a default Network Customer Group Identifier.
	NCOS	0 to 511	This value sets a default network class of service.

CAINXDFT (continued)

CAINXDFT field descriptions (Sheet 5 of 5)

Field	Subfield or refinement	Entry	Explanation and action
		SHFELEGS	SWITCH HOOK FLASH ENABLED LEG. This parameter indicates which leg the SSP will monitor for a switchHookFlash. Enter a vector of up to 2 legs in the SHFELEGS refinement below.
	SHFELEGS	LEG0, LEG1	Enter values LEG0 or LEG1.
		IN1_REQUERY	This value allows the switch to perform an IN1 query at the Analyze_Information PIC on any called party number received in an Analyze_Route message.

Datafill example

The following example shows datafill for table CAINXDFT.

```

CAINGRP      DEFPARMS
-----
VPN1          (COS 0) (PRISTS 111) (ALTSTS 611) $
ANISCRN      (PRISTS 711) (STS 64) (OVFLSTS 901)$
    
```

Table history

UCS12

Updated to add editorial comments.

UCS11

Added shfelegs parameter to the DEFPARMS field (AX1372). Added IN1_REQUERY to the DEFPARMS field (PSD07030).

UCS08

Table AX0206 adds extension parameters PRISTS, ALTSTS, SALTSTS, OVFLSTS.

Table size is reduced by approximately half.

Feature AX0190 adds option STRCONTTP to the DEFPARMS vector.

CAINXDFT (end)

UCS07

Subfields EDPBUFFER, ONOANACT, OCLDBACT, NETBACT, UNIVIDX,
and NETINFO are added.

UCS05

Table CAINXDFT was created.

CALLATTR**Table name**

Call Attribute Translation (CALLATTR) table

Functional description

Integrated Services Digital Network (ISDN) is a digital network capable of carrying voice and data protocols. Primary rate interface (PRI) is part of ISDN where a number of B-channels are supervised by one D-channel. The CALLATTR table supports PRI translations. This table specifies all of the translations and screening information necessary to process PRI calls. Each entry in table CALLATTR is a set of translation and screening parameters for a specific call type associated with table LTCALLS.

Datafill sequence and implications

During ONP, the value CPIBASED will be mapped to NEVER. During a UCS07 to UCS08 or UCS08 to UCS09 ONP, ANIDELV is datafilled with CPNPREF.

Table size

The minimum table size is 0 tuples and the maximum table size is 2048 tuples.

Field descriptions

The following table describes field names, subfield names, and valid data ranges for table CALLATTR.

Field	Subfield or refinement	Entry	Explanation and action
CATTRIDX		0 TO 2047	CALL ATTRIBUTES INDEX. Call attributes index is the key into table CALLATTR.
CUSTOMER		UCS or UCSCUST	CUSTOMER. Depending on which customer type is selected, operating company personnel are prompted with the appropriate fields for that customer. This field specifies the dialing plan used by the operating company. The default value is UCS. See section CUSTOMER=UCS for refinement datafill.

CALLATTR (continued)

Field	Subfield or refinement	Entry	Explanation and action
PRTNM		NPRT or valid pretranslator from table STDPRTCT	<p>Note: The switch may display other values for this field. The only valid values are UCS and UCSCUST.</p> <p>PRETRANSLATION TABLE NAME. If standard pretranslation is required on the incoming side of a trunk group, the pretranslator name previously defined in the table STDPRTCT is held here. Use NPRT for outgoing calls not requiring pretranslation. The default value is NPRT.</p>
COS		0 to 119	CLASS OF SERVICE. Enter the Class of Service code used to screen calls. The default value is 0.
ZEROMPOS		NONE, or position datafilled in table POSITION	ZERO MINUS POSITION. Enter the type of position from table POSITION to use to route zero minus (0-) calls on this trunk group. Otherwise, enter NONE. The default value is NONE.
CUSTAREA	UCS		CUSTOMER AREA REFINEMENTS. See refinements.

CALLATTR (continued)

The following table describes refinements for the field CUSTAREA when CUSTOMER=UCS.

Refinement	Subfield or refinement	Entry	Explanation and action
OPART		0 to 999	ORIGINATING PARTITION. Identifies originating partition for a trunk group. The default value is 7.
BILLTYP		AUTH, CLID, NONE	BILLING TYPE. Select the method of call screening for billing purposes. Enter AUTH to prompt for authorization code information. Enter CLID to screen the calls based on the calling station identifier/calling line identification (CSI/CLID). A value of NONE causes incomplete calls. The default value is AUTH. See section BILLTYP=AUTH for refinement datafill.
DEFCLID		10 digits in form of NXXXXXXXXX (N=2 to 9, X=0 to 9)	DEFAULT CALLING LINE IDENTIFICATION. Enter a valid ANI. The data in this field delivers a full CLID if a partial CLID is received by the UCS DMS-250 switch. The default CLID is an NPA + OFFICE + STATIONS NUMBER. The DEFCLID always datafills this field, even when CLID is not selected as the billing type. Partial datafill of this field is not permitted.
OPTION			OPTION. This field includes several field selections that can be datafilled as needed. These fields are described as follows.
		NIL	Enter NIL to remove an option.

CALLATTR (continued)

Refinement	Subfield or refinement	Entry	Explanation and action
		TCAIN	TERMINATING CAIN. Enter the TCAIN option for the call attribute to trigger on any CAIN events related to the Terminating Call Model.
		TCAINGRP	TERMINATING CAIN GROUP. Enter TCAINGRP to specify the CAINGRP used for the terminating agent. if OPTON=TCAINGRP, datafill the CAINGRP refinement.
	CAINGRP	Valid CAIN group datafilled in table CAINGRP	CAIN GROUP. Enter a valid CAIN group datafilled in table CAINGRP. This refinement is an index into table CAINGRP and can only constrain a valid CAINGRP from table CAINGRP.
		CAIN	CARRIER ADVANCED INTELLIGENT NETWORK. Enter CAIN to indicate the originating agent is capable of using CAIN services.
		CAINGRP	CAIN GROUP. Enter CAINGRP to specify a CAIN subscription group for the originating agent. If OPTION=CAINGRP, datafill the CAINGRP refinement.
	CAINGRP	Valid CAIN group datafilled in table CAINGRP	CAIN GROUP. Enter a valid CAIN group datafilled in CAINGRP. The originating agent subscribes to CAIN services through the CAIN group.
		CUTTHRU	Enter CUTTHRU if address digit prompt is needed. Datafill the ADPROMPT refinement.
	AD PROMPT	Y or N	ADDRESS PROMPT. Enter bool value.

CALLATTR (continued)

Refinement	Subfield or refinement	Entry	Explanation and action
		PRIVDIAL	PRIVATE DIAL. Enter NIL or ESN.
	PRIVDIAL	NILESN	Enter ESN for private dial. Enter NIL to disallow private dial.
		SCRNCL	SERVICE SCREENING CLASS. Enter the SCRNCL option. Datafill the SCRNCL refinement.
	SCRNCL	NSCRTINTTS WBTLAMT- LTN	Enter the SERVICE SCREENING CLASS TABLE NAME.
		ANIDELV	AUTOMATIC NUMBER IDENTIFICATION DELIVERY. Enter option ANIDELV for PRI terminations.
	ANIDELV		Datafill the ANIDELV option with values CPONLY, CGNONLY, CPNPREF, CGNPREF to populate an outgoing CLID.
		CPNLBLK	When the value is CPNLBLK is present for the SS7 PRI terminator, the CPN is not in the outgoing PRI setup message.
		CPNPREF	When the value is CPNPREF, the CPN is used to populate the outgoing CLID. If a CPN is not available or the CPN's PI bit is set to "restricted", the CGN is used to populate the outgoing CLID. If neither a CPN or CGN is available, no CLID is delivered.
		CPNONLY	When the value is CPNONLY, the CPN is used to populate the outgoing CLID. If a CPN is not available or the CPN's PI bit is set to "restricted", no CLID is delivered.

CALLATTR (continued)

Refinement	Subfield or refinement	Entry	Explanation and action
		CGNPREF	When the value entered is CGNPREF, the CGN is used to populate the outgoing CLID. If a CGN is not available, the CPN is used to populate the outgoing CLID. If neither a CPN or CGN is available, or the CPN's PI bit is set to "restricted", no CLID is delivered.
		CGNONLY	When the value entered is CGNONLY, the CGN is used to populate the outgoing CLID. If a CGN is not available, no CLID is delivered.
		ANIATB	The ANIATB option is used for delivering ANI to PRI terminations that are under an all trunks busy (ATB) condition. Datafill the NUMDIGS refinement.
	NUMDIGS	1 to 10	NUMBER OF DIGITS. This field indicates the number of digits of the called party sent to the terminator.
		COSOVE	CLASS OF SERVICE ONVERRIDE INDICATOR. Enter COSOVE if the class of service override is allowed for this call.

CALLATTR (continued)

Refinement	Subfield or refinement	Entry	Explanation and action
		CPN	CALLING PARTY NUMBER. If the CPN option is present in table CALLATTR and a CPN Information Element is not present in the Setup message for the originating PRI trunk then the default CLID will be sent in the calling party number (CPN) parameter rather than the charge number (CGN) parameter of the outgoing ISUP message. The presentation indicator will be set based on the CPN option, PRESENTATION sub-field datafill. Datafill the PRESENTATION refinement.
	PRESENTATION	ALLOWED, RESTRICTED	PRESENTATION. Datafill the refinement.
		DEFCLIDNPT	DEFCLIDNPT. Datafill the NPT refinement. Note: This option is activated when Office parameter BUILD_CHARGEW_FROM_DEFCLID is set to Y and the options are added to a tuple in table CALLATTR.
	NPT	ISDNTYPE, PRIVTYPE	NPT. Enter value ISDNTYPE or PRIVTYPE. Default value = ISDNTYPE.
		DEFOLI	DEFOLI. Data fill the OLI refinement. Note: This option is activated when Office parameter BUILD_CHARGE_FROM_DEFCLID is set to Y and the options are added to a tuple in table CALLATTR.
	OLI	00 to 99	OLI. enter a value, 00 to 99. Default value = 00.

CALLATTR (continued)

Refinement	Subfield or refinement	Entry	Explanation and action
		CLIDBYP	CLIDBYP. This option allows CLID screening in the ANI screening tables to be bypassed for CLID-billed PRI originations.
		BLOCKCPN	BLOCKCPN. This option blocks the Calling Party Number (CPN) parameter from being sent over the SS7 FGD or SS7 IMT (with the ISDNXFER option) unless RTEATTR controls are set to include the CPN.
DEFCIC		{0000 to 9999}	This field contains a default CIC.
LATA		Up to 16 alphanumeric characters	Used to specify a LATA name from Table LATAID.
LANI			Local ANI.
	LANIDIGS	Up to 10 digits	A 10 digit Local ANI.
	PRESIND	{allowed, restricted}	The ISUP presentation indicator.
CPNOVR		N/A	When this option is present the number specified by the LANI option is sent in the Calling Party Number (CPN) ISUP parameter when routing 911 calls.
TRGPREFIX		N/A	When this option is present the DMS appends the SNPA to the 7 digit dialled number.
CBC		N/A	Indicates whether the customer subscribes to the Call-by-Call feature.
RSVD1		N/A	Reserved for future use.
RSVD2		N/A	Reserved for future use.

CALLATTR (continued)

The following table describes refinements for the field.

Refinement	Subfield or refinement	Entry	Explanation and action
ADIN		0 to 99	Enter the number that indexes into table AUTHDIN to determine the authcode screening database. The default value is 0.
VAUTHFLD		numeric (vector of 0 to 15) or NOAUTHS	AUTHORIZATION CODE. Enter the authorization code digits to be filled with the call attribute. when authorization code digits are not filled with the call attribute, enter NOAUTHS to satisfy table control.
AUTHDIAL		0 to 15	NUMBER OF AUTHCODE DIGITS DIALED. This field indicates the number of authcode digits collected. Enter a number other than 0 to collect the authcode CALLATTR tuple.

Datafill example

The following example shows datafill for table CALLATTR.

CATTRIDX CUSTOMER PRTNM COS ZEROMPOS CUSTAREA

```

1      UCS   LSIC  0
NONE  2   AUTH  1
6112211                0
2146112211
(DEFVIC 0288) $
15    UCS   NPRT  0
NONE  2     AUTH  1
6112211                0

```

CALLATTR (continued)

2146112211

(CBC) \$

The following example of table CALLATTR using the CPNLBLK option for the PRI trunk type.

```
CATTRIDX CUSTOMER PRTNM COS ZEROMPOS CUSTAREA
```

```
1 UCS LSIC0 NONE2 AUTH 1 6112211 0 2146112211 (ANIDELV CPNPREF)
(CPNLBLK)
```

\$

Datafill sequence

With respect to the new options. The CIC datafilled against the DEFCIC option should first be datafilled in Table OCCINFO.

If the entry in Table OCCINFO is not present the following warning message is generated:

```
WARNING: THE CIC SPECIFIED IS NOT DATAFILLED IN TABLE OCCINFO.
```

The LATA Name datafilled against the LATA option must first be datafilled in Table LATAID. Table control prevents a LATAID string range from being datafilled that is not already present in Table LATAID. If an attempt is made to add or change a tuple with the RSVD1 option, the following error message is generated:

If an attempt is made to add or change a tuple with the RSVD1 option, the following error message is generated:

```
THE RSVD1 OPTION IS RESERVED AND CANNOT BE DATAFILLED.
```

If an attempt is made to add or change a tuple with the RSVD2 option, the following error message is generated:

```
THE RSVD2 OPTION IS RESERVED AND CANNOT BE DATAFILLED.
```

Supplementary information

If the TCAINGRP option is set, but the TCAIN is not set, the switch generates the following warning:

WARNING: NO TERMINATION BASED TRIGGERING WILL BE DONE FOR CALLS ACCESSING THIS ENTRY IF TCAIN OPTION IS NOT DATA FILLED.

Table history

UCS17

Addition of options: LATA, LANI, DEFCIC, CPNOVRR, TRGPREFIX, CBC, RSVD1, and RSVD2 and table tuples increased from 15 to 24, (A59034551).

Instead of getting the CGN from table TRKGRP as in the case of DAL, the CGN is retrieved from table CALLATTR for incoming PRI calls, (A59034572).

Also, the new option CPNLBLK was added for PRI functionality, (A59038177).

Note: Due to unavailability of the original module, this module was re-created for this release.

UCS14

Updated to add new option CPN to table CALLATTR, (SR60097639).

UCS12

Updated to add editorial changes.

UCS09

Updated to add values CPFONLY, CGNONLY, CPNPREF, and CGNPREF to the ANIDELV option, (AX0993).

UCS08

Updated to add options TCAIN and TCAINGRP, (AX0197).

WARNING: NO TERMINATION BASED TRIGGERING WILL BE DONE FOR CALLS ACCESSING THIS ENTRY IF TCAIN OPTION IS NOT DATA FILLED.

Table history

UCS17

Addition of options: LATA, LANI, DEFCIC, CPNOVRR, TRGPREFIX, CBC, RSVD1, and RSVD2 and table tuples increased from 15 to 24, (A59034551).

Instead of getting the CGN from table TRKGRP as in the case of DAL, the CGN is retrieved from table CALLATTR for incoming PRI calls, (A59034572).

Also, the new option CPNLBLK was added for PRI functionality, (A59038177).

Note: Due to unavailability of the original module, this module was re-created for this release.

UCS14

Updated to add new option CPN to table CALLATTR, (SR60097639).

UCS12

Updated to add editorial changes.

UCS09

Updated to add values CPFONLY, CGNONLY, CPNPREF, and CGNPREF to the ANIDELV option, (AX0993).

UCS08

Updated to add options TCAIN and TCAINGRP, (AX0197).

Digital Switching Systems

UCS DMS-250

Data Schema Reference Manual Volume 1 of 5

Copyright © 1998-2001 Nortel Networks,
All Rights Reserved

NORTEL NETWORKS CONFIDENTIAL: The information contained herein is the property of Nortel Networks and is strictly confidential. Except as expressly authorized in writing by Nortel Networks, the holder shall keep all information contained herein confidential, shall disclose the information only to its employees with a need to know, and shall protect the information, in whole or in part, from disclosure and dissemination to third parties with the same degree of care it uses to protect its own confidential information, but with no less than reasonable care. Except as expressly authorized in writing by Nortel Networks, the holder is granted no rights to use the information contained herein.

Nortel Networks, the Nortel Networks logo, the Globemark, How the World Shares Ideas, and Unified Networks are trademarks of Nortel Networks.

Publication number: 297-2621-851
Product release: UCS15
Document release: Standard 09.02
Date: June 2001
United States of America